

# 2001 ELECTRIC RANGER

## TABLE OF CONTENTS

**NOTE:** Refer to the 2001 Ranger Workshop Manual for all Non-Electric Vehicle (EV) Specific

<b>INTRODUCTION</b>	
<b>GENERAL INFORMATION</b> .....	<b>Volume I</b>
<b>SERVICE INFORMATION</b>	
General Information.....	100-00
Identification Codes.....	100-01
Jacking, Towing and Lifting.....	100-02
Noise, Vibration and Harshness.....	100-04
Standard Service Procedures.....	100-05
Pre-Delivery Form.....	100-06
Electric Vehicle (EV) Diagnostic Direction.....	100-07
Powertrain Diagnostic Routines Identification.....	100-09
<b>CHASSIS</b> .....	<b>Volume I</b>
<b>SUSPENSION</b>	
Rear Suspension .....	204-02
Wheels and Tires.....	204-04
<b>DRIVELINE</b>	
Rear Drive Halfshafts .....	205-05
<b>BRAKE SYSTEM</b>	
Rear Disc Brake.....	206-04
Parking Brake and Actuation .....	206-05
Power Brake Actuation .....	206-07
Anti-Lock Control .....	206-09
<b>STEERING SYSTEM</b>	
Power Steering .....	211-02
Steering Column Switches.....	211-05
<b>POWERTRAIN</b> .....	<b>Volume I</b>
<b>ENGINE</b>	
Basic Motor/Transaxle.....	303-01
Engine Cooling.....	303-03
Electric Motor Management .....	303-14
<b>AUTOMATIC TRANSMISSION</b>	
Automatic Transaxle External Controls.....	307-05
<b>FUEL SYSTEM</b>	
Acceleration Control.....	310-02
<b>ELECTRICAL</b> .....	<b>Volume I</b>
<b>CLIMATE CONTROL SYSTEM</b>	
Air Distribution and Filtering.....	412-01
Heating and Ventilation.....	412-02
Air Conditioning.....	412-03
Control Components .....	412-04
<b>INSTRUMENTATION AND WARNING SYSTEMS</b>	
Instrument Cluster .....	413-01
<b>BATTERY AND CHARGING SYSTEM</b>	
Auxiliary Battery Charging.....	414-02
High Voltage/Traction Battery.....	414-03A
High Voltage/Traction Battery—Nickel Metal Hydride .....	414-03B
<b>ELECTRICAL DISTRIBUTION</b>	
Module Communications Network .....	418-00
<b>INDEX</b>	

**NOTE:** The descriptions and specifications contained in this manual were in effect at the time this manual was approved for printing. Ford Motor Company reserves the right to discontinue models at any time, or change specifications or design without notice and without incurring any obligation.

### **PUBLICATIONS ORDERING INFORMATION**

To obtain information about ordering additional copies of this publication or to order any other Ford or Lincoln/Mercury publications, call 1-800-782-4356. Available publications include workshop manuals, wiring diagrams, PC/ED Manuals and Owner Guides.

In addition, you can obtain a publications order form by writing to: Ford Publications, care of Helm Inc., P.O. Box 07150, Detroit, MI 48207.

All rights reserved. Reproduction by any means, electronic or mechanical, including photocopying, recording, or by any information storage and retrieval system or translation in whole or part is not permitted without written authorization from Ford Motor Company.



**GROUP**

**1**

# General Information

---

SECTION TITLE	PAGE
General Information .....	100-00-1
Identification Codes .....	100-01-1
Jacking, Towing and Lifting .....	100-02-1
Noise, Vibration and Harshness.....	100-04-1
Standard Service Procedures.....	100-05-1
Pre-Delivery Instructions.....	100-06-1
Electric Vehicle (EV) Diagnostic Direction.....	100-07-1
Powertrain Diagnostic Routines Identification .....	100-09-1

---

## SECTION 100-00 General Information

VEHICLE APPLICATION: Ranger EV

CONTENTS	PAGE
<b>DESCRIPTION AND OPERATION</b>	
General Information.....	100-00-2

## DESCRIPTION AND OPERATION

### General Information

#### Format and Usage

The Electric Ranger is a combination of conventional and unique electric vehicle (EV) components and systems. The following procedures are designed to supplement the standard Ranger Workshop Manual for the EV specific components.

This supplement is designed to be the primary manual when working on the EV. All of the EV specific components are covered in this supplement. If a procedure is not outlined in this supplement, refer to the standard Ranger Workshop Manual.

Because the EV uses an electric motor rather than a gasoline engine, there are different and unique warnings and cautions. The procedures outlined are designed to encourage safe repair of the vehicle and should be carefully followed. The EV uses many electronic components that can be easily damaged if the procedures are not followed.

#### Acids

**⚠ WARNING: Lead-acid batteries contain sulfuric acid. Avoid contact with skin, eyes or clothing. Also, shield your eyes when working near batteries to protect against possible splashing of the acid solution. In case of acid contact with the skin or eyes, flush immediately with water for a minimum of fifteen minutes and get prompt medical attention. If acid is swallowed, drink large quantities of milk or water, followed by milk of magnesia, a beaten egg, or vegetable oil. Call a physician immediately.**

The drive battery pack for the Electric Ranger is composed of 39 8-volt lead acid battery modules which are wired in series. These batteries are similar in design to the battery in a gasoline powered vehicle. The batteries contain sulfuric acid which can cause severe skin or eye damage if allowed to contact these areas. Follow all safety precautions outlined in EV-Specific Precautions prior to working on the drive battery pack.

**⚠ WARNING: Batteries normally produce explosive gases which can cause personal injury or death. Do not allow flames, sparks or lighted substances to come near the batteries. When charging or working near the batteries, always shield your face and protect your eyes. Always provide adequate ventilation.**

#### Electric Shock

**⚠ WARNING: The battery pack assembly can deliver in excess of 312 volts of DC power. Improper handling of the battery pack can result in injury or fatality. Only authorized personnel trained to work with battery pack components are permitted to handle the batteries.**

There are two electrical systems on the EV. A high voltage system is used to power the motor/transaxle and many auxiliary loads such as the A/C system, power steering pump, heater and certain control components. High voltage wiring is identified by its orange color or orange wrapping on the harness. Components that have larger connectors, orange coverings on the wires, or warning labels contain high voltage. The second voltage system is used to operate the standard Ranger systems such as interior/exterior lighting, radio, blower motor and instrumentation. These components should be treated with extreme caution. Do not perform any service on them until all high voltage power has been disconnected.

#### EV-Specific Precautions

When working on the traction battery the following precautions must be taken.

1. A buffer zone must be placed around the vehicle or traction battery.
2. Rubber insulating gloves must be worn.
3. A face shield must be worn to shield the face and protect the eyes from electric arc.

---

**DESCRIPTION AND OPERATION (Continued)****Welding Precautions**

The EV requires special care when welding is performed. The sensitive electric components can be damaged by the heat associated with gas welding and the electrical current from electric resistance welding. The following steps must be taken before any welding is done on the EV.

1. Disconnect the 12 volt battery ground cable.
2. If welding within 300 mm (12 in) of the traction battery, remove the traction battery
3. If welding more than 300 mm (12 in) away from the traction battery, disconnect the 76 pin low voltage connector.

4. Remove any electrical modules within 300 mm (12 in) of the welding area.
5. Disarm the passive restraint system. Follow the procedures outlined in the standard Ranger Workshop Manual.
6. Verify that the ignition is in the OFF position.

The traction battery can be stored out of the vehicle for up to 30 days without the serious damage to the battery. If possible, the traction battery should be fully charged prior to storage. After thirty days of storage, the battery should be fully charged. Proper storage will maximize traction battery life.

---

[Manual Table of Contents](#)

# SECTION 100-01 Identification Codes

VEHICLE APPLICATION: Ranger EV

CONTENTS	PAGE
<b>DESCRIPTION AND OPERATION</b>	
Identification Codes .....	<a href="#">100-01-2</a>
Warnings .....	<a href="#">100-01-2</a>

## DESCRIPTION AND OPERATION

### Identification Codes

**NOTE:** For Electric Ranger Only.

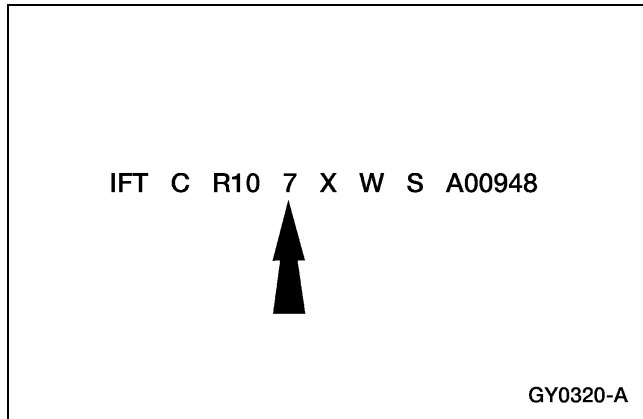

The Vehicle Identification Number (VIN) is located on a tab on the driver’s side dashboard and on the Vehicle Certification Label. The Electric Vehicle (EV) can be identified by checking the engine identification number on the VIN tag. This is the eighth digit on the tag, which indicates the battery pack that is installed in the Electric Vehicle. A number 7 indicates a Lead Acid Battery Pack (PbA) and a number 1 indicates a Nickel Metal Hydride Battery Pack (NiMH). For other VIN information, refer to the **Ranger Workshop Manual**.

### Warnings

The Electric Ranger contains many unique electrical components. The components that operate using high voltage are labeled to warn of the potential danger for electric shock. In addition to the high voltage, some of the components also generate high levels of heat. These are labeled to protect people from possible burns.

### Traction Battery Tray Label

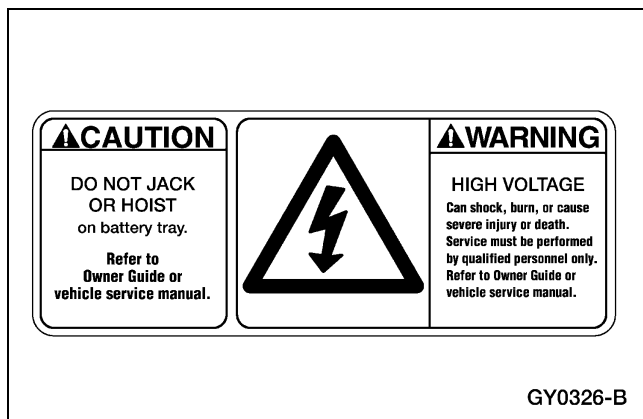

The Traction Battery Tray warning label is located on the left and right sides of the traction battery. The label warns of the potential for electric shock if an unauthorized person attempts to service the traction battery. The label also cautions against lifting the vehicle by the traction battery.

### High Voltage Warning Label

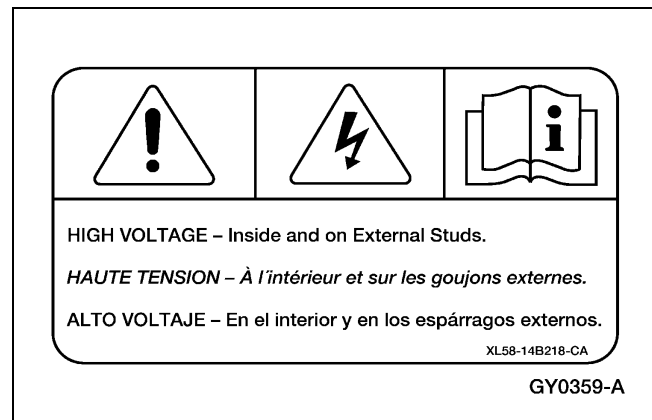

The High Voltage warning label has three icons that contain a general warning, a high voltage warning, and an icon to inform technicians that the proper service information should be used prior to servicing the vehicle.

### High-Voltage Label - High-Voltage Power Distribution Box

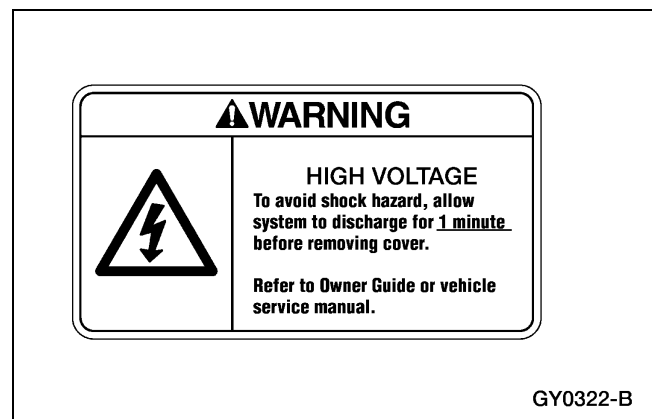

The High-Voltage - High-Voltage Power Distribution Box warning label is located on the high- voltage power distribution box (HVPDB) below the HVPDB cover. This label warns of the need to allow the vehicle to discharge electrically for one minute before removing the inner HVPDB cover.

**DESCRIPTION AND OPERATION (Continued)**

**Nickel Metal Hydride (NiMH) Battery Pack**

This label indicates a Nickel Metal Hydride (NiMH) battery pack.

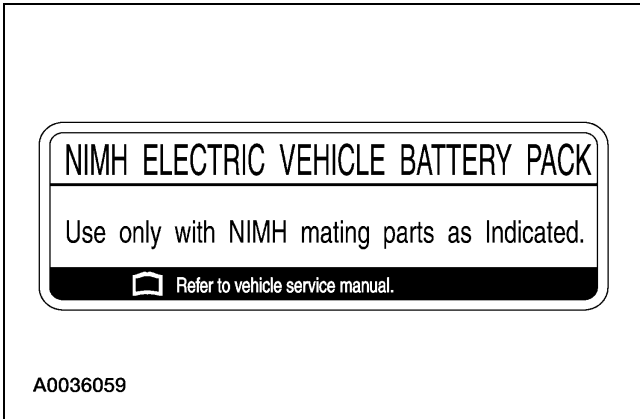

---

[Manual Table of Contents](#)

# SECTION 100-02 Jacking, Towing and Lifting

VEHICLE APPLICATION: Ranger EV

CONTENTS	PAGE
<b>GENERAL PROCEDURES</b>	
Jacking.....	<a href="#">100-02-2</a>
Towing.....	<a href="#">100-02-3</a>



## GENERAL PROCEDURES

### Jacking

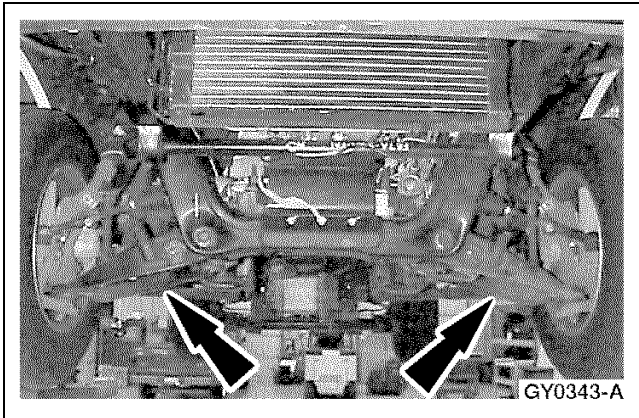

#### Jacking Points —Front

1. Set the parking brake and block the rear wheels.
2. Position the jack under the front A arms and lift the vehicle.

#### Jacking Point —Rear

1. Block the front wheels.

 **CAUTION: Do not lift the vehicle from any point on the axle other than the pads as axle damage may result.**

2. **NOTE:** LH pad shown, RH similar.

Position the jack under the rear axle pad(s) and lift the vehicle. The pads are part of the rear shock absorber mounting points.

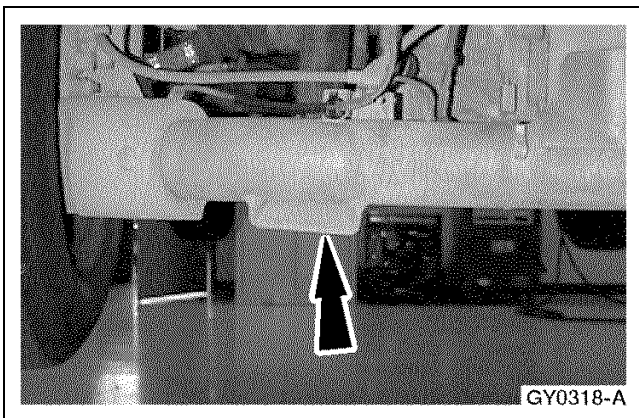

3. Lift the vehicle.

---

**GENERAL PROCEDURES (Continued)****Towing****Pre-Towing Instructions**

**⚠ WARNING:** Tow truck operators should not attempt to service, recharge or operate the vehicle under any circumstances. This vehicle is made up of complex electrical systems, and these operations must be performed by authorized personnel only. Improper handling could result in vehicle damage, personal injury, or death.

**⚠ WARNING:** If the vehicle does not operate properly, do not attempt to jump-start the 12-volt battery or push the vehicle. This could result in vehicle damage, personal injury, or death.

**⚠ WARNING:** Failure to turn the vehicle off before servicing may result in personal injury or death.

**⚠ CAUTION:** Do not disconnect the halfshafts if the motor/transaxle is inoperable. This may result in damage to the motor/transaxle.

1. Verify that the key is in the OFF position.
2. Position the front wheels straight ahead and lock the steering wheel in place using a steering wheel locking device.
3. Depress the brake pedal and release the parking brake.

**Approved Towing Methods****Front Wheel Lift Towing**

**⚠ CAUTION:** There are three approved methods for towing the Electric Ranger. Use of other than the specified methods may cause vehicle damage.

1. Place the gear selector in neutral (N).
2. Lock the front wheels in a straight ahead position with a steering wheel locking device. Do not rely on the column lock to hold the wheels.

---

**GENERAL PROCEDURES (Continued)**

3. Secure the tires to the wheel lift.
4. On normal roads, limit speed to 88km/hr (55mph). On rough roads, limit speed to 56km/hr (35 mph).

**Rear Wheel Lift Towing**

1. Lock the front wheels in a straight ahead position with a steering wheel locking device. Do not rely on the column lock to hold the wheels. If a front wheel locking device is not available, position wheel dollies underneath the front wheels.
2. Secure the tires to the wheel lift.
3. On normal roads, limit speed to 88km/hr (55mph). On rough roads, limit speed to 56km/hr (35 mph).

**Flatbed Towing**

 **CAUTION: Do not pull the vehicle onto the flatbed by the rear axle.**

1. Position the vehicle on the flatbed.
2. Secure the vehicle to the flatbed before towing.

**Lifting**

 **CAUTION: Do not allow the hoist to contact the traction battery pack.**

1. Position the vehicle over a side post hoist.

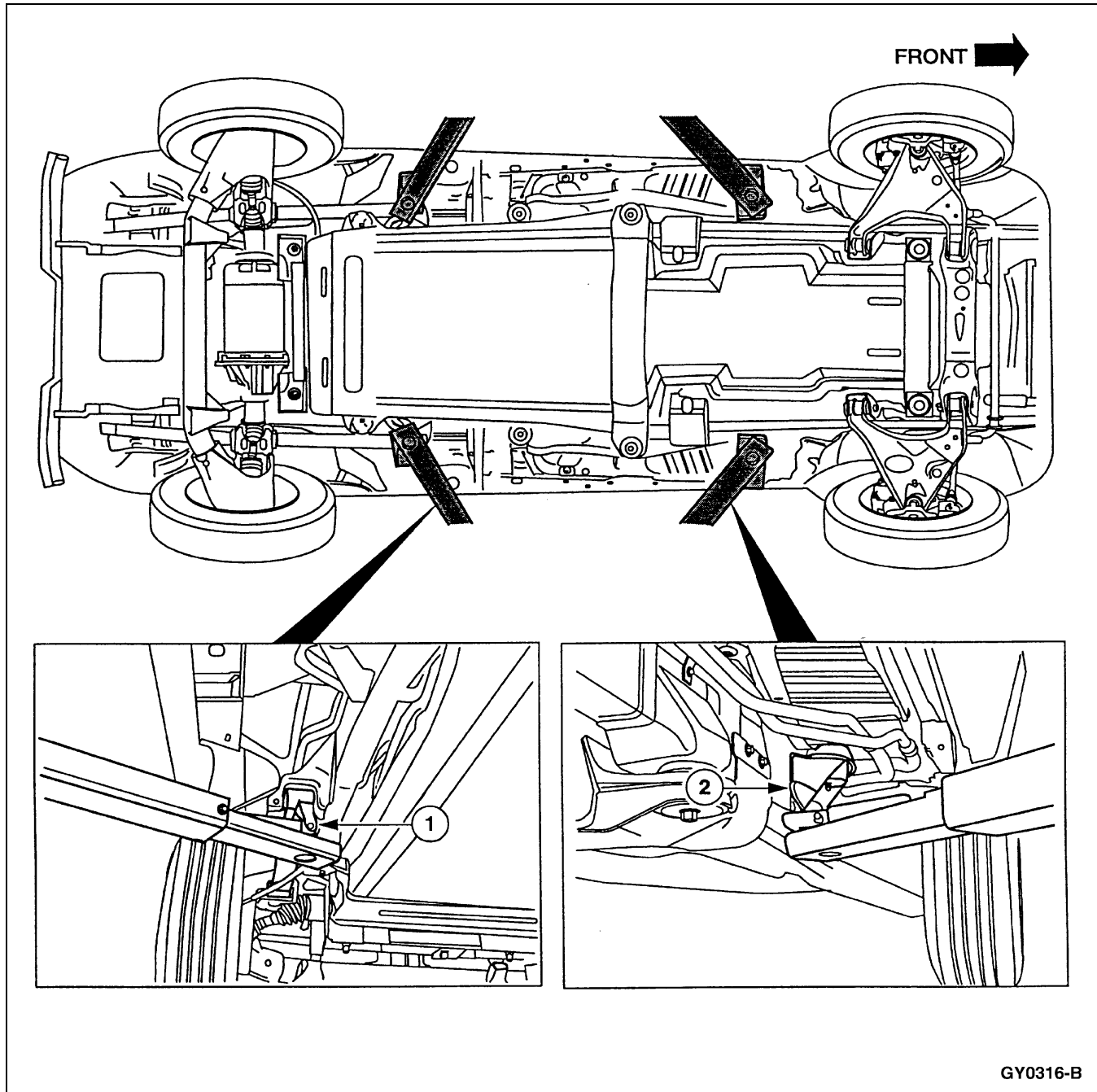
**GENERAL PROCEDURES (Continued)**

2. Position the hoist pad extensions.
  1. Locate the rear hoist pad extensions on the front of the rear leaf spring hanger eyes.
  2. Locate the front hoist pad extensions on the front cab mount extensions.
  
3. Carefully lift the vehicle.

[Manual Table of Contents](#)

# SECTION 100-04 Noise, Vibration and Harshness

VEHICLE APPLICATION: Ranger EV

<b>CONTENTS</b>	<b>PAGE</b>
<b>DESCRIPTION AND OPERATION</b>	
Condenser Fan .....	<a href="#">100-04-2</a>
Condenser Fan —Postal Ranger EV .....	<a href="#">100-04-2</a>
Power Steering Pump .....	<a href="#">100-04-2</a>
Traction Battery Cooling/Ventilation Fan .....	<a href="#">100-04-2</a>
Transaxle .....	<a href="#">100-04-2</a>
Vacuum Pump .....	<a href="#">100-04-2</a>

## DESCRIPTION AND OPERATION

### Condenser Fan

 **WARNING: Disconnect the cooling fan prior to performing any underhood repairs because the fan could cycle.**

The two-speed cooling fan is located behind the radiator, attached to the fan shroud. The cooling fan is controlled by the interface adapter assembly (IAA) that will energize the cooling fan under the following conditions:

- Coolant temperature is higher than normal.
- A/C compressor is on in A/C and Defrost modes when the vehicle speed does not provide enough airflow through the condensor.

Cooling fan noise will be noticed when the vehicle is turned on and the coolant is hot or the A/C is turned on. The fan operation can be verified visually.

### Condenser Fan —Postal Ranger EV

 **WARNING: Disconnect the cooling fan prior to performing any underhood repairs because the fan could cycle.**

The two-speed cooling fan is located behind the radiator, attached to the fan shroud. The cooling fan is controlled by the interface adapter assembly (IAA) that will energize the cooling fan under the following conditions:

- Coolant temperature is higher than normal.

Cooling fan noise will be noticed when the vehicle is turned on and the coolant is hot. The fan operation can be verified visually.

### Power Steering Pump

The power steering pump is located in the underhood compartment between the card table and the inner fender. The power steering pump operates whenever the vehicle is turned on. Pump operation is controlled based upon vehicle speed and steering demands.

The power steering pump will create a whine when operated. This whine can be identified by turning the vehicle on and turning the steering wheel with the vehicle stationary. This will cause the pump motor to increase speed, which will increase the volume and pitch of the whine. Once the steering wheel has been turned and the wheel is released, the pump motor will decrease to minimum speed.

### Traction Battery Cooling/Ventilation Fan

The NiMH traction battery has a recirculation fan and a cooling fan that operate independently of each other to cool the traction battery. The cooling fan exchanges warm air from inside the traction battery with cooler outside air, while the recirculation fan circulates the cool air around the battery modules. The fans will operate during charging or during vehicle usage if the temperature of the modules becomes too high. The sound of the fans when operating is similar to that of an electric radiator cooling fan.

### Transaxle

The transaxle is located in the rear of the vehicle between the rear wheels and contains the electric motor that powers the vehicle. A faint whine may be heard from the transaxle while the vehicle is in motion. The transaxle produces a low-level gear whine directly related to the vehicle speed.

### Vacuum Pump

The vacuum necessary for operation of the Electric Vehicle brake and climate control systems is provided by an electrically driven vacuum pump. This pump is located in the underhood compartment underneath the card table and is visible from the bottom of the vehicle.

Upon start-up of the Electric Vehicle, the first prominent noise that is heard is the vacuum pump. The vacuum pump noise is identified as a buzzing that occurs when the vehicle is first turned on. With the vehicle on and stationary, pump operation will be noticed when the brakes are applied or if the climate control is being operated. The pump will activate to maintain a preset range of vacuum in the system. Constant vacuum pump operation may indicate a vacuum leak.

[Manual Table of Contents](#)

# SECTION 100-05 Standard Service Procedures

VEHICLE APPLICATION: Ranger EV

<b>CONTENTS</b>	<b>PAGE</b>
<b>GENERAL PROCEDURES</b>	
Buffer Zone .....	<a href="#">100-05-2</a>
Rubber Insulating Gloves Testing .....	<a href="#">100-05-2</a>
Traction Battery Auxiliary Load High-Voltage Connector .....	<a href="#">100-05-6</a>
Traction Battery Charging.....	<a href="#">100-05-3</a>
Traction Battery Two-Pin High-Voltage Connector.....	<a href="#">100-05-7</a>
Traction Inverter Module (TIM) Capacitor Discharge .....	<a href="#">100-05-9</a>

## GENERAL PROCEDURES

### Rubber Insulating Gloves Testing

**NOTE:** The rubber insulating gloves that are to be worn while working on all high-voltage systems on the Ranger and the Postal Ranger EV are rated for use on equipment of up to 1000 volts. They must be inspected before use and must always be worn in conjunction with the leather outer glove. Any hole in the rubber insulating glove is a potential entry point for high voltage.

1. Roll the glove up from the open end until the lower portion of the glove begins to balloon from the resulting air pressure. If the glove leaks any air it must not be used.
2. The gloves should not be used if they exhibit any signs of wear and tear.
3. The leather gloves must always be worn over the rubber insulating gloves in order to protect them.
4. The rubber insulating gloves must be class "O" and meet all of the American Safety Testing Materials Standards.

### Buffer Zone

1. **NOTE:** The buffer zone is required only when working with the high-voltage systems on the Electric Vehicle.

Position the vehicle in the service bay.

2. **NOTE:** For Electric Ranger.

Position four orange cones around the corners of the vehicle to mark off a one meter (three feet) perimeter around the vehicle.

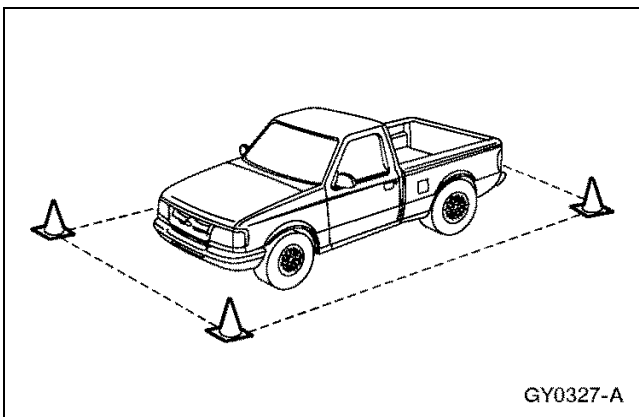

GY0327-A

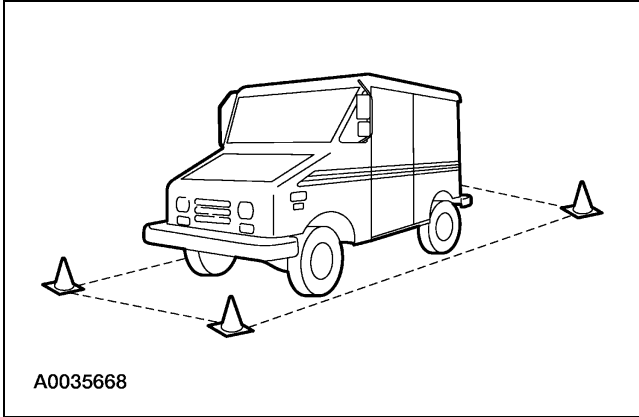

**GENERAL PROCEDURES (Continued)**

3. **NOTE:** For Postal Ranger EV.  
Position four orange cones around the corners of the vehicle to mark off a one meter (three feet) perimeter around the vehicle.

4. Do not allow any unauthorized personnel into the buffer zone during repairs involving high-voltage. Only personnel trained for service on the high voltage systems of the EV are to be permitted in the buffer zone.

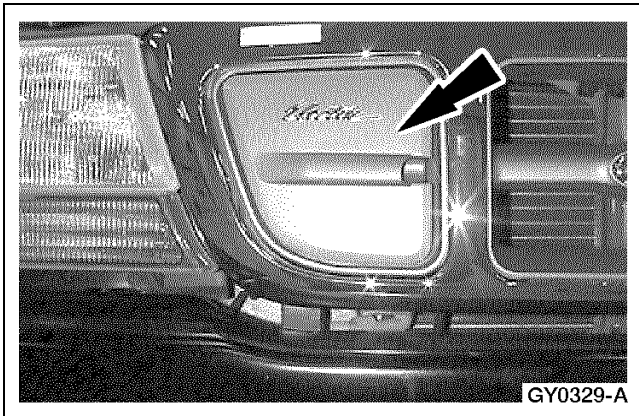
**Traction Battery Charging**

1. Pull the vehicle up to a power control station (PCS).
2. Place the gear selector in the park (P) position and remove the key from the ignition.
3. **NOTE:** For Electric Ranger.  
Open the charger inlet access door.

## GENERAL PROCEDURES (Continued)

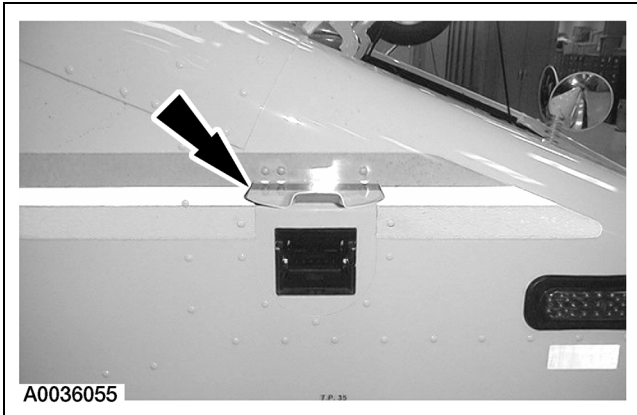

4. **NOTE:** For Postal Ranger EV.  
Open the charger inlet access door.

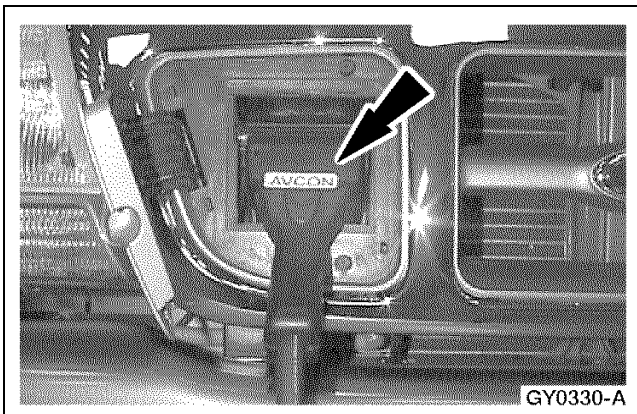

5. **NOTE:** Electric Ranger shown, Postal Ranger EV similar.  
Insert the PCS connector into the charger inlet and push the connector down until it locks into place.

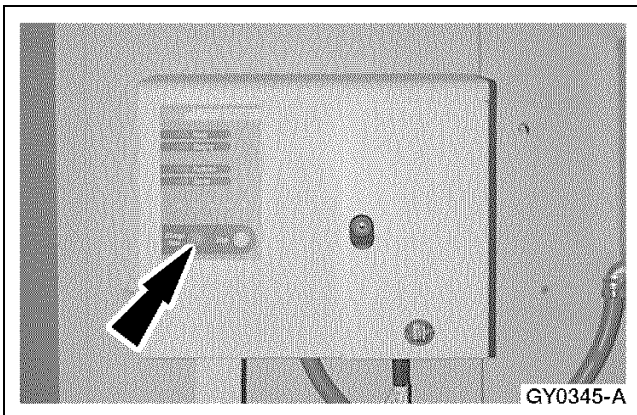

6. If using the EVI PCS and immediate charging of the vehicle is desired, press the Charge Now button. If the economy mode is desired, no further steps are necessary. The EVI unit is equipped with an autostart feature. If the unit is in the economy mode when it is connected to the vehicle, charging will begin automatically.

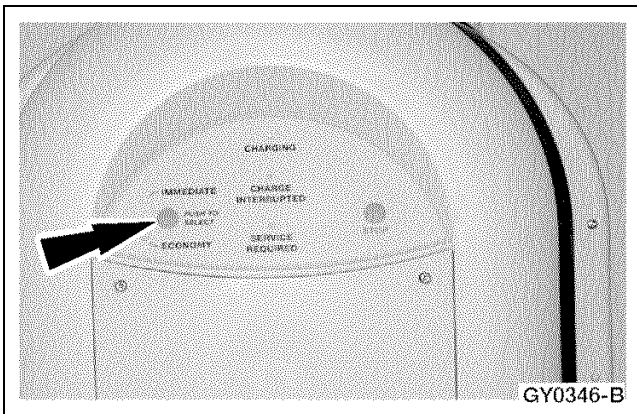

7. **NOTE:** For Electric Ranger.  
The SCI PCS will autostart in either the immediate or economy modes. If using the SCI PCS, press the select button to choose either immediate or economy charging. Charging will begin automatically.

## GENERAL PROCEDURES (Continued)

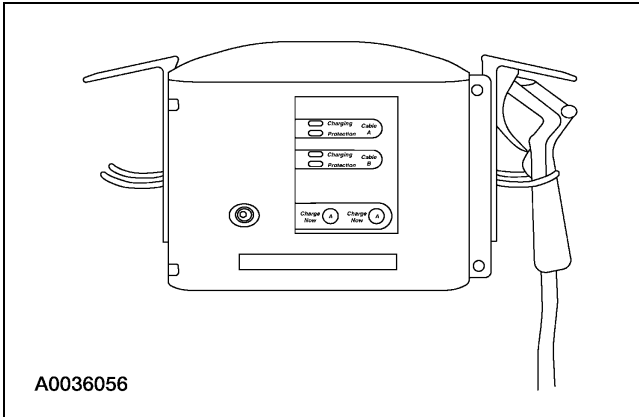

8. **NOTE:** For Postal Ranger EV.

The SCI PCS will autostart in either the immediate or economy modes. If using the SCI PCS, press the select button to choose either immediate or economy charging. Charging will begin automatically.

9. If vehicle charging verification is necessary, connect the New Generation STAR (NGS) Tester to the vehicle and monitor the battery control module (BCM) PID OPSTATE with the ignition key in the OFF position and the vehicle connected to the PCS. To determine what the PID OPSTATE indicates, refer to [Section 100-07](#).
10. If the vehicle is not charging, refer to Traction Battery Charging Diagnosis and Testing, [Section 414-03A](#) or [Section 414-03B](#).

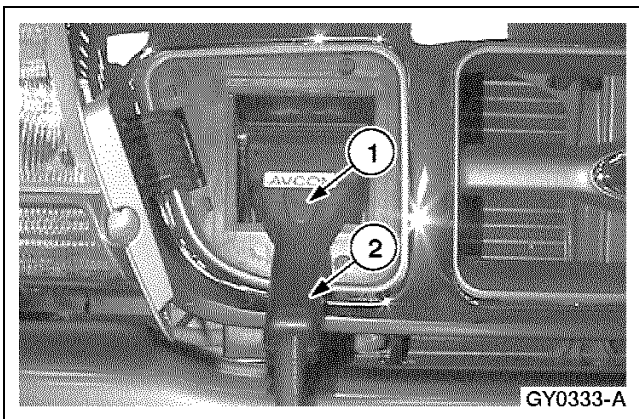

11. **NOTE:** Electric Ranger shown, Postal Ranger EV similar.

After charging, disconnect the PCS connector.

- 1 Press and hold the release button.
- 2 Lift and disconnect the PCS connector.

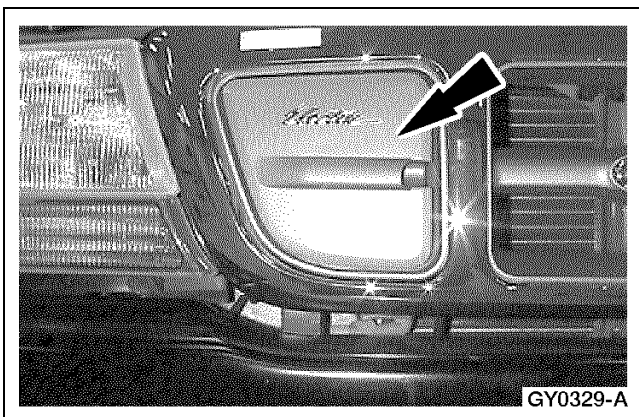

12. Close the charger inlet access door.

## GENERAL PROCEDURES (Continued)

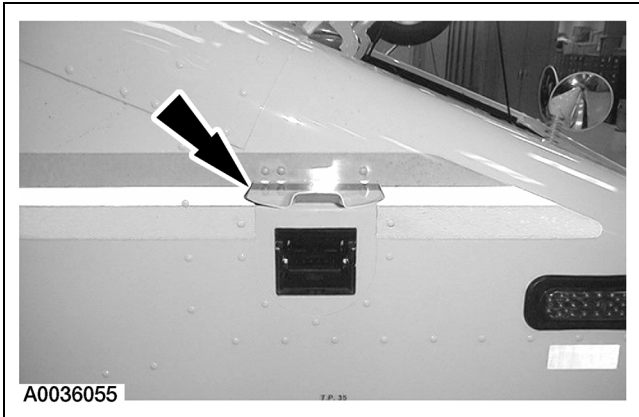

13. **NOTE:** For Postal Ranger EV.  
Close the charger inlet access door.

## Traction Battery Auxiliary Load High-Voltage Connector

### Disconnect

1. **⚠ WARNING:** The nominal traction battery voltage is 300 volts DC. The buffer zone must be set up and insulated rubber gloves and a face shield must be worn. Failure to follow these precautions may result in severe personal injury or death. Observe the EV-specific precautions. Refer to [Section 100-00](#).
  - 1 Set up the buffer zone.
  - 2 Test and wear the rubber insulating gloves.
  - 3 Wear the face shield.
2. If connected, disconnect the vehicle from the power control station (PCS).
3. Disconnect the auxiliary battery ground cable.
4. Raise and support the vehicle. Refer to [Section 100-02](#).
5. **NOTE:** The connector is located at the front of the traction battery on the right side. Disconnect the four-pin high-voltage auxiliary load connector.
  - Pull out the red locking clip while pulling apart the connector.

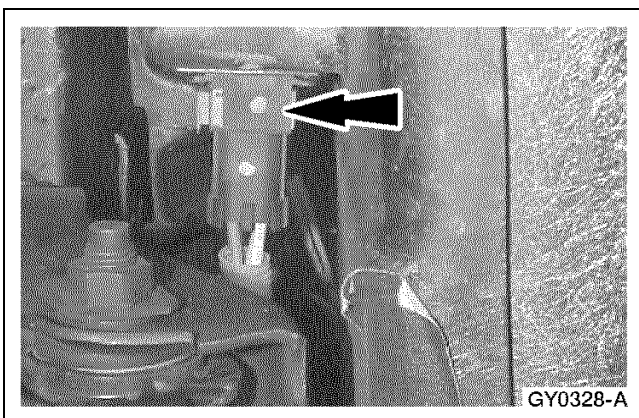

## GENERAL PROCEDURES (Continued)

### Connect

- To connect, reverse the disconnect procedure.

## Traction Battery Two-Pin High-Voltage Connector

### Special Tool(s)

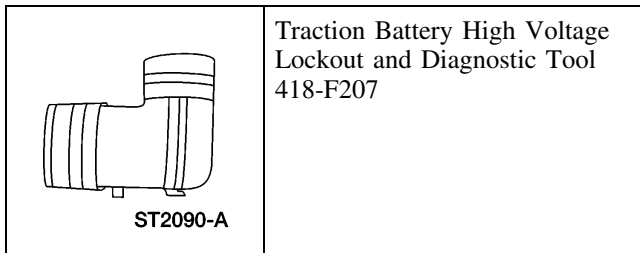

### Disconnect

- ⚠ WARNING: The nominal traction battery voltage is 300 volts DC. The buffer zone must be set up and insulated rubber gloves and a face shield must be worn. Failure to follow these precautions may result in severe personal injury or death.**

Observe the EV-specific precautions. Refer to [Section 100-00](#).

  - Set up the buffer zone.
  - Test and wear the rubber insulating gloves.
  - Wear the face shield.
- Disconnect the auxiliary battery ground cable.
- Raise and support the vehicle. Refer to [Section 100-02](#).
- Remove the cross bar.
  - Remove the bolts.
  - Remove the cross bar.

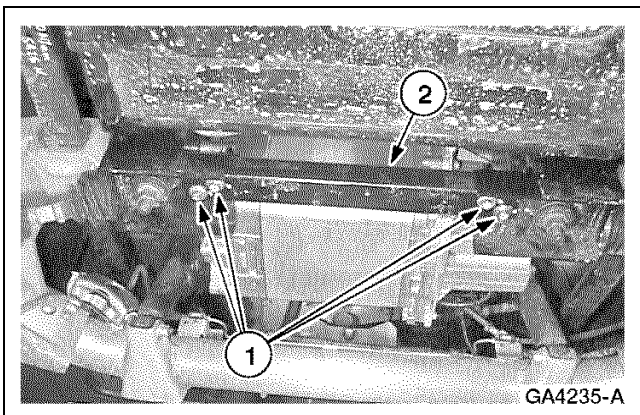

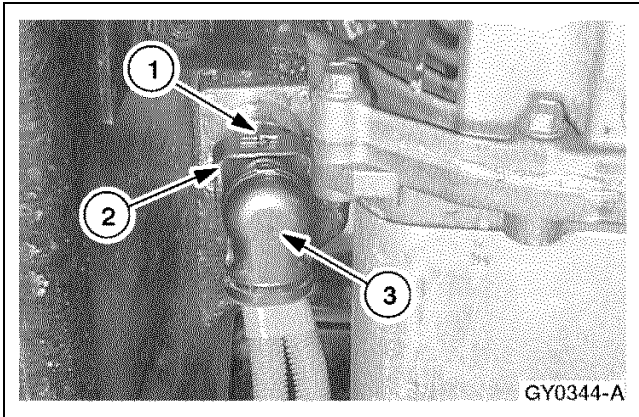
**GENERAL PROCEDURES (Continued)**

5. Disconnect the traction battery two-pin high-voltage connector.

- 1 Remove the retaining pin.
- 2 Lift up on the connector latch.
- 3 Pull the connector out.

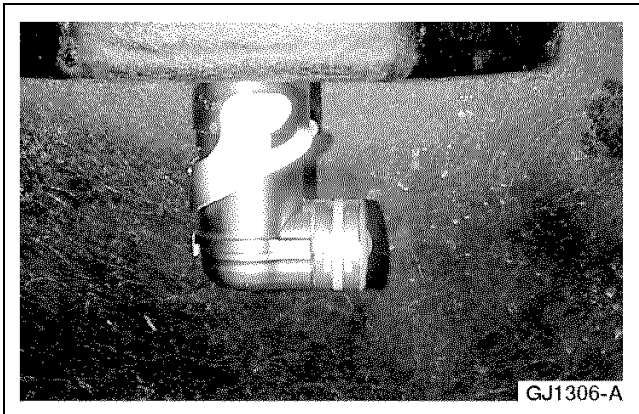

6. Install Traction Battery High Voltage Lockout and Diagnostic Tool in the two-pin high-voltage connector.

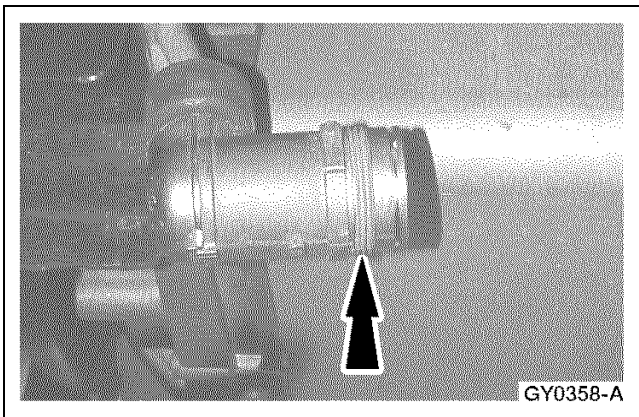

7. Inspect the seal on the two-pin high voltage connector. Replace the seal if it is torn or missing any of the three ribs.

**Connect**

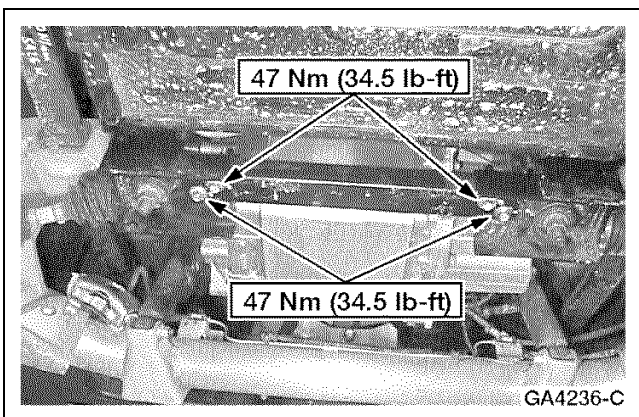

1. To connect, reverse the disconnect procedure.



## GENERAL PROCEDURES (Continued)

### Traction Inverter Module (TIM) Capacitor Discharge

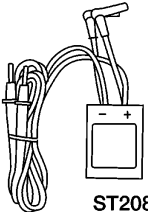
#### Special Tool(s)

 <p>ST2089-A</p>	<p>Capacitor Discharge Tool 418-F213</p>
 <p>ST1137-A</p>	<p>73 Digital Multimeter or Equivalent 105-R0051</p>

1. Disconnect the auxiliary battery ground cable.
2. Raise and support the vehicle. Refer to [Section 100-02](#).
3.  **WARNING: The nominal traction battery voltage is 300 volts DC. The buffer zone must be set up and insulated rubber gloves and a face shield must be worn. Failure to follow these precautions may result in severe personal injury or death.**  
Observe the EV-specific precautions. Refer to [Section 100-00](#).
  - 1 Set up the buffer zone.
  - 2 Test and wear the rubber insulating gloves.
  - 3 Wear the face shield.
4. Remove the cross bar.
  - 1 Remove the bolts.
  - 2 Remove the cross bar.

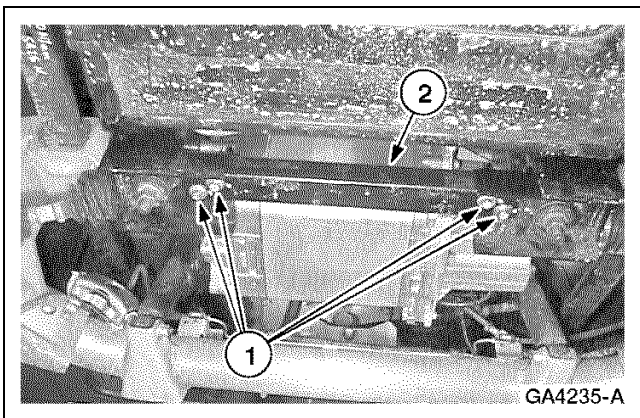

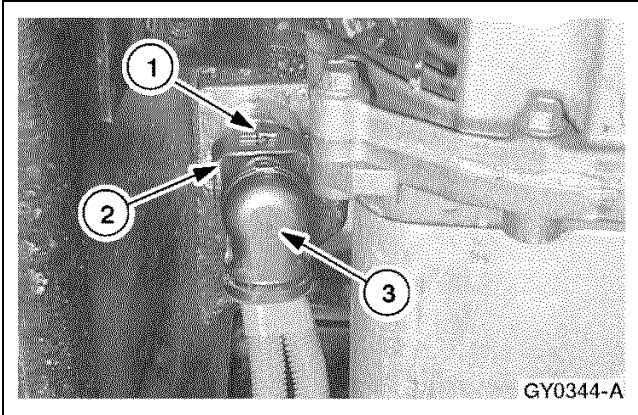
**GENERAL PROCEDURES (Continued)**

5. Disconnect the two-pin high-voltage connector.
  - 1 Remove the retaining pin.
  - 2 Lift up on the connector latch.
  - 3 Pull the connector out.

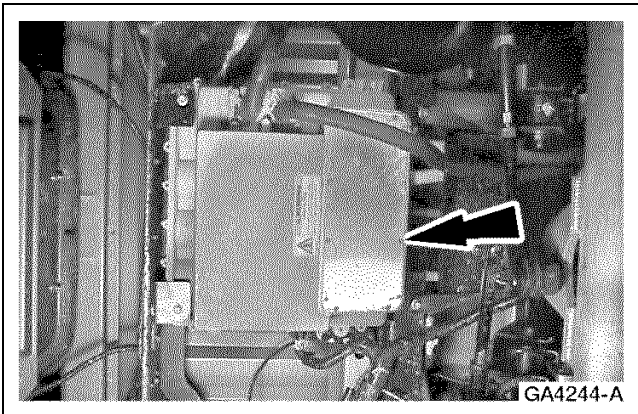

6. Remove the traction inverter module (TIM) cover plate.
  - Remove the 12 screws.

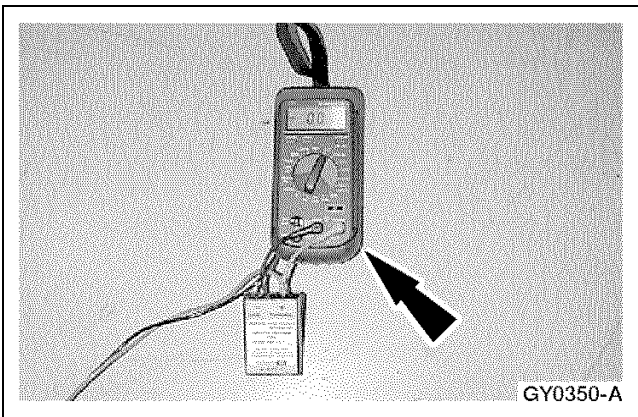

7. Connect the Capacitor Discharge Tool to the Digital Multimeter.
  - Set the multimeter for DC volts.



## GENERAL PROCEDURES (Continued)

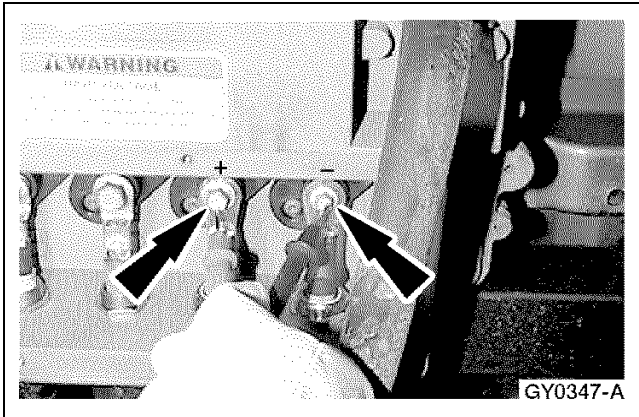

8. **⚠ WARNING: Verify that the voltage is checked across the correct terminals. Wear the rubber insulating gloves. Failure to correctly discharge the capacitors could result in severe personal injury or death.**

**NOTE:** The positive and negative posts are color coded. The positive cable has a red sleeve on the end, and the negative cable has a black sleeve on the end.

Probe the positive and negative terminals of the TIM with the leads from the Capacitor Discharge Tool. The voltmeter will display any voltage present. Continue to probe the terminals until the voltmeter reads 0 volts

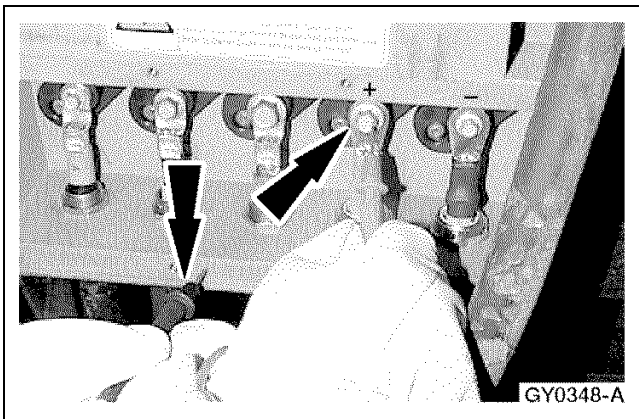

9. Probe the positive terminal and the case of the TIM using the leads from the Capacitor Discharge Tool. The voltmeter will display any voltage present. Continue to probe the terminal and case until the voltmeter reads 0 volts



10. Probe the negative terminal and the case of the TIM using the leads from the Capacitor Discharge Tool. The voltmeter will display any voltage present. Continue to probe the terminal and case until the voltmeter reads 0 volts. The TIM capacitors have now been completely discharged.

---

[Manual Table of Contents](#)

# SECTION 100-06 Pre-Delivery Instructions

VEHICLE APPLICATION: Ranger EV

CONTENTS	PAGE
<b>DESCRIPTION AND OPERATION</b>	
Pre-Delivery Form.....	100-06-2

## DESCRIPTION AND OPERATION

### Pre-Delivery Form

The following pages are pre-delivery sheets that are to be used to check the Electric Ranger prior to customer delivery. Make additional copies of the sheets as needed, and be sure to keep the original in the supplement for future use.



# QUALITY COMMITMENT

## ELECTRIC RANGER PRE-DELIVERY SERVICE RECORD FORM

CHECK/INSPECT THE VEHICLE AS SHOWN.  
PERFORM SPECIFIED ADJUSTMENTS AS REQUIRED.  
REFER TO THE PRE-DELIVERY INSPECTION SECTION  
IN YOUR ELECTRIC RANGER SHOP MANUAL.

### OWNER'S CARD AND DEALER INFORMATION

OWNER'S NAME

ADDRESS

CITY

STATE

ZIP CODE

DEALERSHIP'S NAME

ADDRESS

CITY

STATE

ZIP CODE

--	--	--	--	--	--	--	--	--	--	--	--	--	--	--	--	--	--	--	--

VEHICLE IDENTIFICATION NUMBER (VIN)

IGNITION KEY NO.

TRUNK KEY NO.

STOCK NO.

The undersigned authorized dealership representative certifies that this vehicle has been thoroughly inspected and that all emission compliance requirements and other operations have been performed by a service technician in accordance with the service record for this vehicle, shop manual procedures, and applicable dealer instructions. I understand it is a Ford Motor Company Sales and Service Agreement requirement that this record be retained in the dealership service file for this vehicle.

TECHNICIAN'S SIGNATURE

DATE

AUTHORIZED DEALERSHIP SIGNATURE

DATE

### QUALITY CONCERNS REPORTING

If product quality concerns are noted during the pre-delivery of this unit:

- Call 1-800-322-5621.
- Fax a report to 1-800-329-3377 (for report forms, call 1-800-322-5621).
- Or fill out an Electronic Dealer Service Report (EDSR).

Note: "Check" items are not shown in the order they should be performed.

### CHECK

- 1) Auxiliary battery cables for tightness and proper assembly.
- 2) Auxiliary battery voltage to ensure that battery is fully charged (12.4 volts or above).
- 3) Lines for leaks, damage, and routing:
  - Brake
  - Coolant
  - Steering
  - Air conditioning (if equipped)
- 4) Steering gear, steering linkage, flex coupling, clear vision, and suspension for damaged or loose fasteners and missing parts.

### CHECK AND FILL TO SPECIFICATION

- 1) Tire pressure (including spare).
- 2) Windshield reservoir.
- 3) Cooling system.
- 4) Power steering.
- 5) Brake master cylinder.

### INSTALL LOOSE-SHIPPED ITEMS

- 1) Loose accessories.

### CHECK OPERATION

- 1) Safety belts.
- 2) Seat back latches.
- 3) Lights:
  - Headlamps
  - Tail lamps
  - Turn signals
  - Hazard warning flashers
  - Marker lamps
  - Courtesy lamps
  - Instrument warning indicators
- 4) Air bag readiness light.
- 5) Instruments.
- 6) Parking brake (including warning lamp).
- 7) Steering column lock.
- 8) Starter lock out – Attempt to start vehicle with gear selector in forward and reverse gears.
- 9) Horn.
- 10) Wipers and washers.
- 11) Radio/clock operation and set stations/time.
- 12) Heater, air conditioner, defroster, and ventilation fan systems.
- 13) Safety belt warning system.

### ROAD TEST

- 1) Check driveability during road test. If a problem exists, perform appropriate adjustments to correct it or perform warranty repair.
- 2) Accelerator pedal operation and idle return.
- 3) Check for squeaks, rattles, and vibrations.
- 4) Brakes (including parking brake).
- 5) Steering control.
- 6) Transaxle operation.
- 7) After the road test, fully charge the vehicle and leave vehicle "on charge" if possible.

### APPEARANCE OPERATIONS

- 1) Wash vehicle and perform detailed cleanup of interior and exterior.
- 2) Inspect for interior and exterior metal and paint damage, and touch up as required.
- 3) Place necessary warranty fact booklets, owner card, and owner publications in vehicle, including the EV-specific owner's guide.
- 4) Hang Quick Reference Card from rearview mirror.
- 5) Remove protective covers (body, seats, and carpet).

---

 Manual Table of Contents

# SECTION 100-07 Electric Vehicle (EV) Diagnostic Direction

VEHICLE APPLICATION: Ranger EV

CONTENTS	PAGE
<b>DIAGNOSIS AND TESTING</b>	
Electric Vehicle (EV) Diagnostic Direction .....	100-07-2
Active Command Indices .....	100-07-21
Diagnostic Preface .....	100-07-2
Diagnostic Process .....	100-07-4
Diagnostic Trouble Code (DTC) Indices .....	100-07-7
Battery Control Module (BCM) Diagnostic Trouble Code (DTC) Index —Lead Acid .....	100-07-10
Battery Control Module (BCM) Diagnostic Trouble Code (DTC) Index —NiMH ....	100-07-11
Interface Adapter Assembly (IAA) Module Diagnostic Trouble Code (DTC) Index... .....	100-07-7
Traction Inverter Module (TIM) Diagnostic Trouble Code (DTC) Index .....	100-07-9
Inspection and Verification .....	100-07-6
Operating State Indices .....	100-07-19
Parameter Identification (PID) Indexes.....	100-07-12
Retrieving Diagnostic Trouble Codes (DTCs).....	100-07-3
Special Diagnostic Notes/Cautions/Warnings .....	100-07-2
What's Different About This Manual.....	100-07-2
Miscellaneous Diagnostics.....	100-07-24
Electrical Schematic .....	100-07-24
Pinpoint Tests.....	100-07-25
Symptom Chart .....	100-07-25

## DIAGNOSIS AND TESTING

### Electric Vehicle (EV) Diagnostic Direction

#### Diagnostic Preface

The diagnostic procedures for this supplement are for the Ranger Electric Vehicle (EV) only. Use the 2001 Ranger Workshop Manual for diagnosing systems that are not unique to the Ranger EV. Refer to the **Ranger Electric Vehicle (EV) Electrical Vacuum Troubleshooting Manual (EVTM)** when carrying out diagnostic procedures to note the differences in the systems that are not unique to the Ranger EV. Differences include different fuse feeds, fuse ratings, and wiring changes.

Follow diagnostic process to correctly diagnose the Ranger EV. Read What's Different About This Manual, Special Diagnostic Notes/Cautions/Warnings, and Retrieving Diagnostic Trouble Codes (DTCs) before performing the diagnostic process.

#### What's Different About This Manual

The format of this supplement has been changed to assist in the diagnosis of vehicle concerns. Note the following differences when using this manual:

- This is the diagnostic navigation section. The diagnostic trouble code (DTC) indices, parameter identification (PID) indices, and active command indices for the interface adapter assembly (IAA) module, traction inverter module (TIM), and battery control module (BCM) are all contained in this section.
  - There are no separate DTC indices in each section for the system with the concern. The DTCs have been added to the symptom charts to provide direction to the appropriate pinpoint test.
- The inspection and verification process used in all diagnostic sections are consolidated in this section.
- DTC definitions relating to the system with the concern are at the beginning of the diagnosis and testing to assist in the diagnostic procedures.
- The Special Tool(s) charts precede the pinpoint tests.
  - There are no illustrations for the Special Tool(s) charts.

- Multiple diagnostic checks have been combined in test steps to avoid lengthy pinpoint tests.
  - There are no illustrations in the pinpoint tests to assist in the diagnosis. Connector face views can be accessed from the Ranger Electric Vehicle (EV) Electrical Vacuum Troubleshooting Manual (EVTM).
- Miscellaneous diagnostics that do not pertain to any particular system have been included in this section.

#### Special Diagnostic Notes/Cautions/Warnings

The following special notes, cautions, and warnings relate to performing diagnostic procedures and must be adhered to:

**⚠ WARNING: The Ranger Electric Vehicle (EV) contains high-voltage components and wiring. Do NOT perform any high-voltage diagnostic procedures unless indicated to do so. Follow all safety precautions before performing high-voltage diagnostic procedures. Failure to follow this warning may result in severe personal injury or death.**

- Carry out high-voltage diagnostic procedures only when indicated to do so.

**⚠ CAUTION: The New Generation STAR (NGS) Tester maximum voltage rating is 200 volts. Do NOT use the NGS Tester to measure high-voltage power. Failure to follow this caution will cause damage to the NGS Tester.**

- Do not use the NGS Tester to measure high-voltage power.

**NOTE:** If possible, charge the traction battery to a full state of charge (SOC) before carrying out any diagnostic procedures. A power limit concern may cause other vehicle system concerns.

- Check the instrument cluster traction battery SOC gauge before performing any diagnostic procedures. A low SOC may cause other vehicle system concerns due to a power limit concern. If necessary (and possible), charge the traction battery to a full SOC before performing diagnostic process.

## DIAGNOSIS AND TESTING (Continued)

**NOTE:** If the vehicle will not start and the malfunction indicator lamp (MIL), power limit warning indicator, low state of charge (SOC) indicator, auxiliary battery indicator, red brake warning indicator, and/or electrical hazard warning indicator are illuminated and there are no diagnostic trouble codes (DTCs) present on any of the modules, it may be necessary to charge the traction battery to a full state of charge (SOC).

- If the vehicle will not start and the malfunction indicator lamp (MIL), power limit warning indicator, low state of charge (SOC) indicator, auxiliary battery indicator, red brake warning indicator, and/or electrical hazard warning indicator are illuminated and no DTCs exist on any of the modules, connect the vehicle to a power control station (PCS) and use the New Generation STAR (NGS) Tester to monitor battery control module (BCM) PID BCM\_\_OP. Press the START button on the PCS and monitor the BCM\_\_OP PID for approximately 5 minutes. If the BCM\_\_OP PID indicates 48 (Shutdown-Low Module Voltage) or 114 (LOS charge-Low Battery Voltage), allow the vehicle to charge to a full SOC. If the BCM\_\_OP PID indicates 96 (EPO Detected), disconnect the negative auxiliary battery cable, wait approximately one minute, and reconnect.

### Retrieving Diagnostic Trouble Codes (DTCs)

The process for retrieving diagnostic trouble codes (DTCs) is the same for the interface adapter assembly (IAA) module and the battery control module (BCM). The IAA module and BCM use continuous DTCs and on-demand self-tests to determine concerns in their systems. The traction inverter module (TIM) uses only continuous DTCs to determine concerns within its system. It does not have on-demand self-test capability. Refer to the DTC indices to determine if it is necessary to retrieve continuous DTCs and carry out on-demand self-tests for the IAA module and BCM. Note the following concerns that relate to retrieving DTCs:

**NOTE:** Do not carry out diagnostic procedures for IAA module DTC C1862 Contactor Circuit Failure unless there is a multiple auxiliary load failure and DTC C1862 occurs after the IAA module on-demand self-test is performed. A multiple auxiliary load failure occurs when the power steering, DC/DC converter, heating system, and air conditioning (if equipped) fail to operate.

- The IAA module logs DTCs C1862 Contactor Circuit Failure, U1110 SCP (J1850) Invalid/Missing Data for Primary ID 6E, and U1117 Invalid Data for Electrical Energy Management in continuous memory when the on-demand self-test is performed by the BCM. Do not carry out diagnostic procedures for IAA module DTC C1862 unless there is a multiple auxiliary load failure and DTC C1862 occurs after the IAA module on-demand self-test is performed.
- IAA module DTC U1262 SCP (J1850) Communication Bus Fault may occur if the ignition key is quickly cycled ON/OFF/ON. This may cause the malfunction indicator lamp (MIL) to illuminate. If this occurs, clear the IAA module DTCs and slowly cycle the ignition key.
- TIM DTC C1184 ABS System Is Not Operational occurs if the ignition key is cycled OFF/ON too fast. Do not carry out any pinpoint tests related to the ABS unless the yellow ABS warning indicator is illuminated and ABS DTCs occur.
- The red brake warning indicator and malfunction indicator lamp (MIL) illuminate and TIM DTC U2015 Signal Link Fault (Non SCP) occurs if the ignition key is cycled OFF/ON before the anti-lock brake control module completes its pump check. If this occurs, clear the TIM DTCs, turn the ignition key to the ON position, and wait for the completion of the ABS pump check. Carry out the diagnostic procedures only if TIM DTC U2015 occurs after the completion of the ABS pump check.

**DIAGNOSIS AND TESTING (Continued)****Diagnostic Process****PINPOINT TEST DP: DIAGNOSTIC PROCESS**

TEST STEP	ACTION TO TAKE
<p><b>DP1 VERIFY CUSTOMER CONCERN</b></p> <p><b>NOTE:</b> Check technical service bulletins (TSBs), OASIS, and vehicle repair records before proceeding. Also, check for any non-factory add-on equipment. Determine if any of these have impact on vehicle concern.</p> <ul style="list-style-type: none"> <li>Verify the customer concern is valid by operating the system(s) in question.</li> <li><b>Is the customer concern valid?</b></li> </ul>	<p>Yes = GO to <b>DP2</b>.</p> <p>No = ENSURE customer understands the operating characteristics of the vehicle.</p>
<p><b>DP2 PERFORM INSPECTION AND VERIFICATION</b></p> <ul style="list-style-type: none"> <li>Perform a system inspection for the system(s) in question. Refer to Inspection and Verification in this section.</li> <li><b>Are any obvious concerns detected?</b></li> </ul>	<p>Yes = REPAIR as necessary and RETEST.</p> <p>No = GO to <b>DP3</b>.</p>
<p><b>DP3 PERFORM DATA LINK DIAGNOSTICS NETWORK TEST</b></p> <ul style="list-style-type: none"> <li>Run the DATA LINK DIAGNOSTICS Network Test.</li> <li><b>Is SYSTEM PASSED obtained?</b></li> </ul>	<p>Yes = GO to <b>DP4</b>.</p> <p>No = REFER to <a href="#">Section 418-00</a>.</p>
<p><b>DP4 DETERMINE IF CONCERN IS RELATED TO VEHICLE CHARGING</b></p> <ul style="list-style-type: none"> <li>Determine if concern is related to vehicle charging.</li> <li><b>Was vehicle brought in for repair due to a vehicle charging concern?</b></li> </ul>	<p>Yes = GO to <b>DP5</b>.</p> <p>No = GO to <b>DP6</b>.</p>
<p><b>DP5 RETRIEVE DIAGNOSTIC TROUBLE CODES (DTCs) FROM BATTERY CONTROL MODULE (BCM)</b></p> <ul style="list-style-type: none"> <li>Access DTCs from BCM and record codes, including previous OP_State (PREV_OP).</li> <li>Clear continuous DTCs from the BCM.</li> <li>Connect the vehicle to a power control station (PCS) and press the START button to begin charging.</li> <li>Wait approximately five minutes and retrieve continuous DTCs from the BCM. Note the DTCs.</li> <li>Clear continuous DTCs (if necessary) and perform the BCM on-demand self-test. Note the DTCs.</li> <li><b>Does DTC C1838 Charging System Fault occur?</b></li> </ul>	<p>Yes = REFER to Traction Battery Charging/Heating System in <a href="#">Section 414-03A</a> or <a href="#">Section 414-03B</a>.</p> <p>No = REFER to <a href="#">Section 100-09</a> Powertrain Diagnostic Routines Identification for symptom-related charging diagnostics.</p>
<p><b>DP6 RETRIEVE DTCs FROM INTERFACE ADAPTER ASSEMBLY (IAA) MODULE</b></p> <ul style="list-style-type: none"> <li>Retrieve continuous DTCs from the IAA module. Note the DTCs.</li> <li>Clear the continuous DTCs.</li> </ul>	<p>Yes = REFER to the Interface Adapter Assembly (IAA) Module Diagnostic Trouble Code (DTC) Index. CARRY OUT the appropriate diagnostic procedures. GO to <b>DP7</b>.</p> <p>No = GO to <b>DP7</b>.</p>

(Continued)



**DIAGNOSIS AND TESTING (Continued)****PINPOINT TEST DP: DIAGNOSTIC PROCESS**

TEST STEP	ACTION TO TAKE
<p><b>NOTE:</b> It may take up to one minute for a DTC to be set in IAA module continuous memory. If the concern is related to climate control, turn on the system in question.</p> <ul style="list-style-type: none"> <li>• Wait one minute and retrieve continuous DTCs from the IAA module. Note the DTCs.</li> <li>• Clear continuous DTCs (if necessary) and perform the IAA module on-demand self-test. Note the DTCs.</li> <li>• <b>Do any DTCs occur?</b></li> </ul>	
<p><b>DP7 RETRIEVE DTCs FROM TRACTION INVERTER MODULE (TIM)</b></p> <ul style="list-style-type: none"> <li>• Retrieve continuous DTCs from the TIM. Note the DTCs.</li> <li>• Clear the continuous DTCs.</li> </ul> <p><b>NOTE:</b> It may take up to one minute for a DTC to be set in TIM continuous memory. Some TIM DTCs will not be set unless the vehicle is driven.</p> <ul style="list-style-type: none"> <li>• Wait one minute and retrieve continuous DTCs from the TIM. Note the DTCs.</li> <li>• <b>Do any DTCs occur?</b></li> </ul>	<p>Yes = REFER to the Traction Inverter Module (TIM) Diagnostic Trouble Code (DTC) Index. CARRY OUT the appropriate diagnostic procedures. GO to <b>DP8</b>.</p> <p>No = GO to <b>DP8</b>.</p>
<p><b>DP8 RETRIEVE DTCs FROM BATTERY CONTROL MODULE (BCM)</b></p> <ul style="list-style-type: none"> <li>• Retrieve DTCs from the BCM. Note the DTCs.</li> <li>• Clear the continuous DTCs.</li> <li>• Retrieve continuous DTCs from the BCM. Note the DTCs.</li> <li>• Clear continuous DTCs (if necessary) and perform the BCM on-demand self-test. Note the DTCs.</li> <li>• <b>Do any DTCs occur?</b></li> </ul>	<p>Yes = REFER to the Battery Control Module (BCM) Diagnostic Trouble Code (DTC) Index. CARRY OUT the appropriate diagnostic procedures.</p> <p>No = If no DTCs occur for any of the modules and the vehicle exhibits abnormal powertrain symptoms, REFER to <a href="#">Section 100-09</a> Powertrain Diagnostic Routines Identification for symptom-related diagnostics.</p> <p>If no DTCs occur for any of the modules and there is a system concern related to the heating system, air conditioning system, cooling system, power steering system, vacuum system, or instrument cluster, REFER to the Symptom Chart in the appropriate section for symptom-related diagnostics.</p>

(Continued)

**DIAGNOSIS AND TESTING (Continued)****PINPOINT TEST DP: DIAGNOSTIC PROCESS**

TEST STEP	ACTION TO TAKE
	If no DTCs occur for any of the modules and the heater, air conditioning (if equipped), power steering, and DC/DC converter all do not operate, REFER to Multiple Auxiliary Load Failure Diagnosis in <a href="#">Section 414-03A</a> or <a href="#">Section 414-03B</a> .

**Inspection and Verification**

1. Visually inspect the system's components. Check for obvious signs of electrical and mechanical damage.
2.  **WARNING: The vehicle contains high-voltage components and wiring. High-voltage insulated safety gloves and face shield must be worn when performing the following step for high-voltage systems. Failure to follow this warning may result in severe personal injury or death.**  
Check the wiring and connectors to detect concerns due to looseness, corrosion, or other damage.
3. If any obvious case for an observed or reported concern can be found, correct the cause of the concern before proceeding to the next step.
4. If the cause of the concern cannot be found by system inspection, proceed to the next step (in test step DP2) in Diagnostic Process.

**Electrical**

- Fuse(s)
- Auxiliary battery/cables
- Auxiliary battery voltage
- Integrity of connectors
- Integrity of wiring

**Mechanical**

- Section 206-07 Vacuum System
  - Vacuum system leak
  - Integrity of vacuum hose(s)/line(s)
  - Vacuum hose/line connection(s)
  - Vacuum hose/line routing
  - Climate control vacuum reservoir
  - Vacuum pump housing rubber isolator mounts
- Section 206-09 Anti-Lock Control
  - Parking brake cable
  - Tire pressure
  - Tire size or mismatched tires
  - Anti-lock brake sensor mounting
  - Tone ring
- Section 211-02 Power Steering
  - Power steering fluid leak
  - Low power steering fluid level
  - Power steering fluid reservoir
  - Power steering pump hoses/tubes

**DIAGNOSIS AND TESTING (Continued)**

- Section 303-01 Basic/Motor Transaxle (Motor/Transaxle Lubrication System)
  - Oil leak
  - Low oil level
  - Oil drain plug
  - Halfshaft flange seal(s)
  - Gear cover
- Section 303-03 Cooling System
  - Cooling system leak
  - Low coolant level
  - Integrity of cooling system hose(s)/tube(s)
  - Cooling fan
- Section 303-14 Electric Motor Management (Traction Inverter Module Control System)
  - Motor/transaxle connector (corroded)
- Section 307-05 Automatic Transaxle External Controls (Digital Transmission Range Sensor)
  - Shift cable linkage
  - Shift cable alignment
  - Digital transmission range (DTR) sensor adjustment
  - Transmission range selector lever
- Section 310-02 Acceleration Control
  - Accelerator pedal assembly
- Section 412-02 Heating/Defrosting (Heating/Defrosting/Ventilation)
  - Climate control air filter
  - Vacuum motor actuator arms
- Section 412-03 Air Conditioning
  - Low refrigerant
  - Refrigerant leak
  - Climate control air filter
  - Vacuum motor actuator arms
- Section 413-01 Instrument Cluster
  - Stuck gauge(s)
  - Low oil level
  - Low traction battery charge
  - Low coolant level
  - Tripped inertia switch
  - Low brake fluid level
  - Parking brake set
  - Charger cord plugged in
- Section 414-02 Auxiliary Battery Charging
  - Auxiliary battery casing
- Section 414-03 High Voltage/Traction Battery
  - Low traction battery state of charge (SOC)
  - Tripped inertia switch
  - High-voltage connector disconnected
  - Power control station (PCS) plugged into charger inlet
  - Charger inlet
  - Vehicle not in PARK during charging
  - Stuck cooling/ventilation fan

**Diagnostic Trouble Code (DTC) Indices****Interface Adapter Assembly (IAA) Module Diagnostic Trouble Code (DTC) Index****Interface Adapter Assembly (IAA) Module Diagnostic Trouble Code (DTC) Index**

<b>DTC</b>	<b>Test Mode</b>	<b>Description</b>	<b>Action</b>
U1041	Continuous	SCP (J1850) Invalid/Missing Data for Vehicle Speed	No action required.
U1108	Continuous	Invalid Data for Electronic Traction Drive	No action required.
U1110	Continuous	SCP (J1850) Invalid/Missing Data for Primary ID \$6E	No action required.
U1117	Continuous	Invalid Data for Electrical Energy Management	No action required.
U1131	Continuous	SCP (J1850) Invalid/Missing Data for Fuel System	No action required.
U1262	Continuous	SCP (J1850) Communication Bus Fault	No action required.
B1238	Continuous	Over Temperature Fault	REFER to Page 412-02-3.

(Continued)

**DIAGNOSIS AND TESTING (Continued)****Interface Adapter Assembly (IAA) Module Diagnostic Trouble Code (DTC) Index**

<b>DTC</b>	<b>Test Mode</b>	<b>Description</b>	<b>Action</b>
B1249	Continuous, On-Demand	Blend Door - Failure	REFER to Page 412-02-3.
B1250	Continuous, On-Demand	Air Temperature Internal Sensor Circuit Failure	REFER to Page 412-02-3.
B1254	Continuous, On-Demand	Air Temperature External Sensor Circuit Failure	REFER to Page 412-02-3.
B1317	Continuous	Battery Voltage - High	REFER to Page 412-02-3.
B1318	Continuous	Battery Voltage - Low	REFER to Page 412-02-3.
B1342	Continuous, On-Demand	ECU - Defective	REFER to Page 100-07-24 in this section.
B1555	Continuous	Ignition Run/Start - Circuit Failure	REFER to Page 100-07-24 in this section.
P1461	Continuous, On-Demand	A/C Pressure Sensor Circuit High Input	REFER to Page 412-03-3.
C1774	Continuous, On-Demand	Coolant Temperature Out of Range	REFER to Page 303-03-4.
C1775	Continuous, On-Demand	DC-DC Converter Failure	REFER to Page 412-02-3.
C1776	Continuous	Heater System Failure	REFER to Page 412-02-3.
C1777	Continuous, On-Demand	Vacuum Pressure Circuit Failure	REFER to Page 206-07-3.
C1778	Continuous	Power Steering Failure	REFER to Page 211-02-3.
C1779	Continuous, On-Demand	Blower Switch Failure	REFER to Page 412-02-3.
C1780	Continuous, On-Demand	Temperature Select Failure	REFER to Page 412-02-3.
C1834	Continuous	Gauge Drive Current Fault	REFER to Page 413-01-7.
B1857	Continuous, On-Demand	Climate Control On/Off Switch Circuit Failure	REFER to Page 412-02-3.
C1862	Continuous, On-Demand	Contactors Circuit Failure	REFER to Auxiliary Contactor Relay Control in Pages 414-03A-5, 414-03A-10, 414-03A-16 (lead acid vehicles) or Pages 414-03B-6, 414-03B-11, 414-03B-16 (NiMH vehicles).
B1946	Continuous	A/C Post Evaporator Sensor Circuit Failure	REFER to Page 412-03-3.
U2015	Continuous, On-Demand	Signal Link Fault (Non SCP)	REFER to Page 412-02-3.
B2119	Continuous	Compressor Failure	REFER to Page 412-02-3.
B2513	Continuous, On-Demand	Blower (Fan) Circuit Failure	REFER to Page 412-02-3.
B2514	Continuous, On-Demand	Blower (Fan) Circuit Short to Vbat	REFER to Page 412-02-3.
B2515	Continuous, On-Demand	Heater Blower Relay Circuit Failure	REFER to Page 412-02-3.
B2516	Continuous, On-Demand	Blower Control Circuit Failure	REFER to Page 412-02-3.

(Continued)

**DIAGNOSIS AND TESTING (Continued)****Interface Adapter Assembly (IAA) Module Diagnostic Trouble Code (DTC) Index**

DTC	Test Mode	Description	Action
B2517	Continuous	Emergency Power Off System Faulted	REFER to Page 414-03A-18 (lead acid vehicles) or Page 414-03B-18 (NiMH vehicles).
B2518	Continuous	Compressor Overtemp Fault	REFER to Page 412-03-3.
B2606	Continuous	A/C Temperature Sensor Out of Range	REFER to Page 412-03-3.

**Traction Inverter Module (TIM) Diagnostic Trouble Code (DTC) Index****Traction Inverter Module (TIM) Diagnostic Trouble Code (DTC) Index**

DTC	Test Mode	Description	Action
C1184	Continuous	ABS System Is Not Operational	REFER to Page 206-09-3.
U1262	Continuous	SCP (J1850) Communication Bus Fault	No action required.
C1284	Continuous	Oil Pressure Switch Failure	REFER to Page 303-01-3.
B1342	Continuous	ECU - Defective	REPLACE the TIM. REFER to <a href="#">Section 303-14</a> .
C1446	Continuous	Brake Switch - Circuit Failure	REFER to Regenerative Braking in Page 414-03A-40 (lead acid vehicles) or Page 414-03B-37 (NiMH vehicles).
B1676	Continuous	Battery Pack Voltage Out of Range	REFER to Main/Precharge Contactor Relay Control in Page 414-03A-10 (lead acid vehicles) or Page 414-03B-11 (NiMH vehicles).
C1750	Continuous	Acceleration Position Sensor Out of Range	REFER to Page 310-02-3.
C1755	Continuous	Power Limit Shutdown	REFER to Traction Battery System in Page 414-03A-69 (lead acid vehicles) or Page 414-03B-71 (NiMH vehicles).
C1849	Continuous	Master Cylinder Pressure Out of Range	REFER to Regenerative Braking in Page 414-03A-40 (lead acid vehicles) or Page 414-03B-37 (NiMH vehicles).
C1854	Continuous	Motor Temperature Out of Range	REFER to Page 303-14-2.
C1855	Continuous	Acceleration Position Sensor Conflict	REFER to Page 310-02-3.
C1856	Continuous	Traction Motor Encoder Circuit Failure	REFER to Page 303-14-2.
C1860	Continuous	PRNDL Input #3 Circuit Failure	REFER to Page 307-05-2.
C1861	Continuous	PRNDL Input #4 Circuit Failure	REFER to Page 307-05-2.
C1862	Continuous	Contactor Circuit Failure	REFER to Main/Precharge Contactor Relay Control in Pages 414-03A-5, 414-03A-10, 414-03A-16 (lead acid vehicles) or Pages 414-03B-6, 414-03B-11, 414-03B-16 (NiMH vehicles).
U2015	Continuous	Signal Link Fault (Non SCP)	REFER to Page 206-09-4.
B2477	Continuous	Module Configuration Failure	REFER to Page 100-07-24 in this section.

**DIAGNOSIS AND TESTING (Continued)****Battery Control Module (BCM) Diagnostic Trouble Code (DTC) Index —Lead Acid****Battery Control Module (BCM) Diagnostic Trouble Code (DTC) Index —Lead Acid**

<b>DTC</b>	<b>Test Mode</b>	<b>Description</b>	<b>Action</b>
U1041	Continuous	SCP (J1850) Invalid/Missing Data for Vehicle Speed	No action required.
U1243	Continuous	SCP (J1850) Invalid/Missing Data for Exterior Environment	No action required.
U1262	Continuous	SCP (J1850) Communication Bus Fault	No action required.
B1342	Continuous, On-Demand	ECU - Defective	CARRY OUT BCM On-Demand Self-Test three times. If DTC B1342 keeps occurring, REPLACE the BCM. REFER to <a href="#">Section 414-03A</a> .
B1671	Continuous, On-Demand	Battery Module Voltage Out of Range	REFER to Traction Battery System in Page 414-03A-69.
B1676	Continuous, On-Demand	Battery Pack Voltage Out of Range	REFER to Traction Battery System in Pages 414-03A-10 and 414-03A-69.
P1794	Continuous, On-Demand	Battery Voltage Circuit Malfunction	REFER to Traction Battery System in Page 414-03A-69.
C1835	Continuous, On-Demand	Current Sense Circuit Failure	REFER to Contactor Box Current Sensors in Page 414-03A-22.
C1836	Continuous, On-Demand	Battery Temperature Out of Range	REFER to Traction Battery Charging/Heating System in Page 414-03A-43.
C1837	Continuous, On-Demand	Battery Heater Circuit Failure	REFER to Traction Battery Charging/Heating System in Page 414-03A-43.
C1838	Continuous, On-Demand	Charging System Fault	REFER to Traction Battery Charging/Heating System in Page 414-03A-44.
C1839	Continuous	Leakage Fault	REFER to Current Leakage Detection in Page 414-03A-26.
C1859	On-Demand	PRNDL Input #2 Circuit Failure	REFER to Traction Battery Charging/Heating System in Page 414-03A-44.
C1861	On-Demand	PRNDL Input #4 Circuit Failure	REFER to Traction Battery Charging/Heating System in Page 414-03A-44.
C1862	Continuous, On-Demand	Contactor Circuit Failure	REFER to Negative Main Contactor Relay Control in Pages 414-03A-5, 414-03A-10, 414-03A-16.
C1863	Continuous	External Charging Fault	REFER to Traction Battery Charging/Heating System in Page 414-03A-44.
C1864	Continuous, On-Demand	Battery Module Fault	REFER to Traction Battery System in Page 414-03A-70.
B2137		Engineering Development Code	No action needed.

(Continued)

**DIAGNOSIS AND TESTING (Continued)****Battery Control Module (BCM) Diagnostic Trouble Code (DTC) Index —Lead Acid**

<b>DTC</b>	<b>Test Mode</b>	<b>Description</b>	<b>Action</b>
B2236	Continuous	Weak or Defective Electric Vehicle Battery Module Fault	REFER to Traction Battery System in Page 414-03A-70.
B2247	Continuous	Electric Vehicle Battery Pack Temperature Fault	REFER to Traction Battery/Charging System in Page 414-03A-44.
B2477	Continuous	Module Configuration Failure	REFER to Page 100-07-24 in this section.
B2513	Continuous, On-Demand	Blower (Fan) Circuit Failure	REFER to Traction Battery Cooling/Ventilation System in Page 414-03A-65.

**Battery Control Module (BCM) Diagnostic Trouble Code (DTC) Index —NiMH****Battery Control Module (BCM) Diagnostic Trouble Code (DTC) Index —NiMH**

<b>DTC</b>	<b>Test Mode</b>	<b>Description</b>	<b>Action</b>
U1041	Continuous	SCP (J1850) Invalid/Missing Data for Vehicle Speed	No action required.
U1243	Continuous	SCP (J1850) Invalid/Missing Data for Exterior Environment	No action required.
U1262	Continuous	SCP (J1850) Communication Bus Fault	No action required.
B1342	Continuous, On-Demand	ECU - Defective	CARRY OUT BCM On-Demand Self-Test three times. If DTC B1342 keeps occurring, REPLACE the BCM. REFER to <a href="#">Section 414-03B</a> .
B1671	Continuous, On-Demand	Battery Module Voltage Out of Range	REFER to Traction Battery System in Page 414-03B-70.
B1676	Continuous, On-Demand	Battery Pack Voltage Out of Range	REFER to Traction Battery System in Page 414-03B-70.
P1794	Continuous, On-Demand	Battery Voltage Circuit Malfunction	REFER to Traction Battery System in Page 414-03B-70.
C1835	Continuous, On-Demand	Current Sense Circuit Failure	REFER to Contactor Box Current Sensors in Page 414-03B-22.
C1836	Continuous, On-Demand	Battery Temperature Out of Range	REFER to Traction Battery Charging/Heating System in Page 414-03B-40.
C1838	Continuous, On-Demand	Charging System Fault	REFER to Traction Battery Charging/Heating System in Page 414-03B-41.
C1839	Continuous	Leakage Fault	REFER to Current Leakage Detection in Page 414-03B-25.
C1859	On-Demand	PRNDL Input #2 Circuit Failure	REFER to Traction Battery Charging/Heating System in Page 414-03B-41.
C1861	On-Demand	PRNDL Input #4 Circuit Failure	REFER to Traction Battery Charging/Heating System in Page 414-03B-41.

(Continued)

**DIAGNOSIS AND TESTING (Continued)****Battery Control Module (BCM) Diagnostic Trouble Code (DTC) Index —NiMH**

<b>DTC</b>	<b>Test Mode</b>	<b>Description</b>	<b>Action</b>
C1862	Continuous, On-Demand	Contactor Circuit Failure	REFER to Negative Main Contactor Relay Control in Pages 414-03B-6, 414-03B-11, 414-03B-16.
C1863	Continuous	External Charging Fault	REFER to Traction Battery Charging/Heating System in Page 414-03B-41.
C1864	Continuous, On-Demand	Battery Module Fault	REFER to Traction Battery System in Page 414-03B-71.
B2136		Engineering Development Code	No action needed.
B2236	Continuous	Weak or Defective Electric Vehicle Battery Module Fault	REFER to Traction Battery System in Page 414-03B-71.
B2477	Continuous	Module Configuration Failure	REFER to Page 100-07-24 in this section.
B2513	Continuous, On-Demand	Blower (Fan) Circuit Failure	REFER to Traction Battery Cooling/Ventilation System in Page 414-03B-63.

**Parameter Identification (PID) Indexes****Interface Adapter Assembly (IAA) Module  
Parameter Identification (PID) Index****Interface Adapter Assembly (IAA) Module Parameter Identification (PID) Index**

<b>PID</b>	<b>Description</b>	<b>Expected Values</b>
A/CPRES	A/C Pressure	KPA
AC_CTMP	A/C Compressor Temperature	°C, °F
AC_LOWP	A/C Low Pressure Switch	ENABLED, DISABLED
AC_PRST	A/C Present	YES, NO
ACPEVAP	A/C Post Evaporator Sensor	°C, °F
AUX_HVB	Auxiliary High Voltage Bus	AVAILABLE, UNAVAILABLE, LIMITED, EPO, INERTIA SWITCH
AUX_HVC	Auxiliary High Voltage Contactor	OPEN, CLOSED, OFAULT, CFAULT
AUXCN_I	Auxiliary Contactor Input Status	ENABLE, DISABLE
AUXCNIF	Auxiliary Contactor Input Fault	YES, NO
AUXCNO	Auxiliary Contactor Output Status	ENABLE, DISABLE
BFSV	Blower/Fan Sense Voltage	V (Volts)
BLENDDR	Blend Door Position	% (Percent)
BLOWER	Blower Switch Status	LOW, MED__1, MED__2, HIGH, INVLD
C/M_SPD	Compressor/Motor Speed	RPM
CC_MODE	Climate Control Mode	MAX__A/C, A/C, PL/FL, OFF, FL/DEF, INVLD
CCNT	Number of Continuous DTCs in Module	Integer Value
CLNTTMP	Coolant Temperature	°C, °F
CORE__A	Core A Status	ON, OFF, FAULT, RETRY, SHORT
CORE__AF	Core A Fault	YES, NO
CORE__B	Core B Status	ON, OFF, FAULT, RETRY, SHORT

(Continued)



**DIAGNOSIS AND TESTING (Continued)****Interface Adapter Assembly (IAA) Module Parameter Identification (PID) Index**

PID	Description	Expected Values
CORE__BF	Core B Fault	YES, NO
DCDC__OC	DC-DC Over Current Fault	YES, NO
EMG__PO	Emergency Power Off Status	ENABLE, DISABLE
EXT__FT2	External Temperature Sensor Filtered Data #2	°C, °F
EXT__FT3	External Temperature Sensor Filtered Data #3	°C, °F
EXT__UT2	External Temperature Sensor Unfiltered Data #2	°C, °F
HTR__CAI	Heater Core A - Input Status	ON, OFF
HTR__CAO	Heater Core A - Output Status	ENABLE, DISABLE
HTR__CAR	Heater Core A in Retry	YES, NO
HTR__CBI	Heater Core B - Input Status	ON, OFF
HTR__CBO	Heater Core B - Output Status	ENABLE, DISABLE
HTR__CBR	Heater Core B in Retry	YES, NO
HTR__OT	Heater Over Temperature	YES, NO
HTR__PWR	Heater Power	ENABLE, DISABLE
HTR__SHT	Heater Short	YES, NO
IAA__OP	ECU Operating State	Integer Value (Refer to Interface Adapter Assembly (IAA) Module Operating State Index for a detailed description of integer value.)
IGN__R/S	Ignition Switch - Run/Start Position	YES, NO
INER__SW	Inertia Switch Status	ENABLE, DISABLE
INTMP__2	Interior Actual Temperature #2	°C, °F
MAXCOOL	Maximum Cool Blend Door Position	% (Percent)
MAXWARM	Maximum Warm Blend Door Position	% (Percent)
PTC__PF	PTC Processor Fault	YES, NO
SET__TMP	Set Temperature	% (Percent)
SWITCHM	Switching Module	OK, OFF, FAULT, OVER__T
VACPRES	Vacuum Pressure	KPA
VAPSFLT	Power Steering Fault	YES, NO
VBATIAA	System Battery Voltage Value #1	V (Volts)

**Traction Inverter Module (TIM) Parameter Identification (PID) Index****Traction Inverter Module (TIM) Parameter Identification (PID) Index**

PID	Description	Expected Values
ABS__WI	ABS Warning Indicator Input Status	ENABLE, DISABLE
ABS__SIG	ABS Active Input Signal Status	ACTIVE, notACT
AP1V	Accelerator Position 1 Voltage	V (Volts)
AP2V	Accelerator Position 2 Voltage	V (Volts)
AP3V	Accelerator Position 3 Voltage	V (Volts)
BAT__PV	Battery Pack Voltage	V (Volts)
BOO__TIM	Brake Pedal Switch	ON, OFF

(Continued)

**DIAGNOSIS AND TESTING (Continued)****Traction Inverter Module (TIM) Parameter Identification (PID) Index**

<b>PID</b>	<b>Description</b>	<b>Expected Values</b>
CCNT	Number of Continuous DTCs in Module	Integer Value
EMG__PO	Emergency Power Off Input Status	ENABLE, DISABLE
IGN__S	Ignition Switch - Start Position	YES, NO
MC__PRES	Master Cylinder Pressure	V (Volts)
OIL__PCO	Oil Pump Control Output Status	ON, OFF
OILPSWI	Oil Pressure Switch Input Status	ACTIVE, notACT
PRECH__F	Precharge Fault	YES, NO
PRNDE__1	PRNDE Transmission Range 1 Input Status	ACTIVE, notACT
PRNDE__2	PRNDE Transmission Range 2 Input Status	ACTIVE, notACT
PRNDE__3	PRNDE Transmission Range 3 Input Status	ACTIVE, notACT
PRNDE__4	PRNDE Transmission Range 4 Input Status	ACTIVE, notACT
RPM	Engine RPM	RPM
TIM__OP	ECU Operating State	Integer Value (Refer to Traction Inverter Module Operating State Index for a detailed description of integer value.)
TIMTEMP	Traction Inverter Temperature	°C, °F
TRNTEMP	Trans/Motor Temperature	°C, °F
TPCCO	Traction Pre-Charge Contactor Output Status	ENABLE, DISABLE
TPCCOF	Traction Pre-Charge Contactor Output Fault	YES, NO
TPMCO	Traction Positive Main Contactor Output Status	ENABLE, DISABLE
TPMCOF	Traction Positive Main Contactor Output Fault	YES, NO
TRANSGR	Transmission Gear	D6__PRK, REV, NTRL, DRIVE5, DRIVE4
VSS2TIM	Speedometer Gauge Indicator Control	KPH, MPH

**Battery Control Module (BCM) Parameter Identification (PID) Index —Lead Acid****Battery Control Module (BCM) Parameter Identification (PID) Index —Lead Acid**

<b>PID</b>	<b>Description</b>	<b>Expected Values</b>
12V__BAT	12V Battery Module Installed	YES, NO
AUX__CNT	Auxiliary Current	AMP
AUX__SEN	Auxiliary Sensor Voltage	V (Volts)
AVGTEMP	Average Temperature	°C, °F
BAT__H1	Battery Heater 1	ENABLE, DISABLE
BAT__H1F	Battery Heater 1 Fault	YES, NO
BAT__H2	Battery Heater 2	ENABLE, DISABLE
BAT__H2F	Battery Heater 2 Fault	YES, NO
BAT__INT	Battery Integrity	Integer Value
BAT__MC	Battery Module Capacity	AMHR (Amp-Hours)
BAT__MV	Battery Module Voltage	V (Volts)
BAT__PV	Battery Pack Voltage	V (Volts)
BAT__SOC	Battery Pack State of Charge (SOC)	% (Percent)

(Continued)

**DIAGNOSIS AND TESTING (Continued)****Battery Control Module (BCM) Parameter Identification (PID) Index —Lead Acid**

PID	Description	Expected Values
BATTMP1	Battery Temperature Sensor 1 Out of Range	YES, NO
BATTMP2	Battery Temperature Sensor 2 Out of Range	YES, NO
BATTMP3	Battery Temperature Sensor 3 Out of Range	YES, NO
BATTMP4	Battery Temperature Sensor 4 Out of Range	YES, NO
BCM_OP	ECU Operating State	Integer Value (Refer to Battery Control Module Operating State Index for a detailed description of integer value.)
BTM_1FT — BTM_39FT	Battery Module Fault	YES, NO
CCNT	Number of Continuous DTCs in Module	Integer Value
CHG_ABD	Charger Charging After Being Disabled	YES, NO
CHG_CAP	Charging Capacity	% (Percent)
CHG_CCF	Charger Cord Circuit Fault	YES, NO
CHG_CO	Charger Contactor Output Status	ENABLE, DISABLE
CHG_COF	Charger Contactor Output Fault	YES, NO
CHG_CYC	Charge Cycles	Integer Value
CHG_CYF	Charger Cycling Fault	YES, NO
CHG_LCF	Charger Line Capacity Fault	YES, NO
CHG_LUF	Charger Latch-Up Fault	YES, NO
CHG_LVL	Charging Level Output Status	% (Percent)
CHG_MFF	Charger Mode Feedback Fault	YES, NO
CHG_OAF	Charger Over Amp-Hours Fault	YES, NO
CHG_OCF	Charger Over Current Fault	YES, NO
CHG_OTF	Charger Over-Temperature Fault	YES, NO
CHG_OVF	Charger Over Voltage Fault	YES, NO
CHG_UCF	Charger Under Current Fault	YES, NO
CHGCHGR	Charger Charging Input Status	YES, NO
CHGCORD	Charger Cord Input Status	IN, OUT
CHGFLT	Charger Fault Input Status	YES, NO
CHGMAX	Charger Max Line Input Status	ENABLE, DISABLE
CHGMODE	Charger Mode Output Status	CURRENT, VOLTAGE
CHGOUT	Charger Output Status	ENABLE, DISABLE
CHGPLT	Charger Pilot Output Status	ENABLE, DISABLE
CHGPWR	Charger Power Output Status	ENABLE, DISABLE
CHGRDY	Charger Ready Input Status	YES, NO
CUR_SEN	Current Sense Control	ENABLE, DISABLE
CUS_SOC	Customer State of Charge (SOC)	% (Percent)
D_TIME	Total Drive Time	SEC (Seconds)
EMG_PO	Emergency Power Off Input Status	ENABLE, DISABLE
FAN_DIS	Fan Disabled Due to High Temperature in Battery Pack	YES, NO
FAN_FB	Blower Fan Feedback	ENABLE, DISABLE
FAN_PWR	Blower Fan Power	ENABLE, DISABLE

(Continued)

**DIAGNOSIS AND TESTING (Continued)****Battery Control Module (BCM) Parameter Identification (PID) Index —Lead Acid**

PID	Description	Expected Values
HIGHTMP	High Temperature Delta in Battery Pack	YES, NO
HTRPRST	Heater Present	YES, NO
IGN__R	Ignition Switch - Run Position	YES, NO
LEAK__CF	Leakage Circuit Failure	YES, NO
LEAK__DF	Leakage During Drive Fault	YES, NO
LEAK__ID	Battery Pack Leakage Module Identification	Integer Value
LEAKHCF	High Level Leakage During Charge Fault	YES, NO
LEAKLCF	Low Level Leakage During Charge Fault	YES, NO
LEAKRES	Parallel Combination of Bus Leakage Resistance	OHM
LKRESB+	Leakage Resistance (Bus +)	OHM
LKRESB-	Leakage Resistance (Bus -)	OHM
LOWVOLT	Low Voltage Flags	Integer Value
MAINSEN	Main Sensor Voltage	V (Volts)
MAXTCHG	Maximum Temperature Change	°C, °F
MAXTEMP	Maximum Temperature	°C, °F
MINTEMP	Minimum Temperature	°C, °F
NMBICO	Negative Main Bus Inhibit Contactor Output Status	ENABLE, DISABLE
NMBICOF	Negative Main Bus Inhibit Contactor Output Fault	YES, NO
PREV__OS	Previous ECU Operating State	Integer Value (Refer to Battery Control Module Operating State Index for a detailed description of integer value.)
PWM__DC3	PWM Duty Cycle #3 (Fan Speed)	% (Percent)
REV__BAT	Reverse Battery Module Installed	YES, NO
SOC	State of Charge	% (Percent)
TMPSEN1	Temperature Sensor 1	°C, °F
TMPSEN2	Temperature Sensor 2	°C, °F
TMPSEN3	Temperature Sensor 3	°C, °F
TMPSEN4	Temperature Sensor 4	°C, °F
TPMCOF	Traction Battery Main Contactor Output Fault	YES, NO
TRAC__MC	Traction Main Current	AMP
TRANSGR	Transmission Gear	D6__PRK, notPRK
WKDFBMF	Weak/Defective Battery Module Fault	YES, NO
WRG__BCM	Wrong BCM Hardware Installed	YES, NO

**Battery Control Module (BCM) Parameter Identification (PID) Index —NiMH****Battery Control Module (BCM) Parameter Identification (PID) Index —NiMH**

PID	Description	Expected Values
AUX__CNT	Auxiliary Current	AMP
AUX__SEN	Auxiliary Sensor Voltage	V (Volts)

(Continued)

**DIAGNOSIS AND TESTING (Continued)****Battery Control Module (BCM) Parameter Identification (PID) Index —NiMH**

PID	Description	Expected Values
AVGTEMP	Average Temperature	°C, °F
BAT__INT	Battery Integrity	Integer Value
BAT__MC	Battery Module Capacity	AMHR (Amp-Hours)
BAT__MV	Battery Module Voltage	V (Volts)
BAT__PV	Battery Pack Voltage	V (Volts)
BAT__SOC	Battery Pack State of Charge (SOC)	% (Percent)
BATTMP1	Battery Temperature Sensor 1 Out of Range	YES, NO
BATTMP2	Battery Temperature Sensor 2 Out of Range	YES, NO
BATTMP3	Battery Temperature Sensor 3 Out of Range	YES, NO
BATTMP4	Battery Temperature Sensor 4 Out of Range	YES, NO
BCM__OP	ECU Operating State	Integer Value (Refer to Battery Control Module Operating State Index for a detailed description of integer value.)
BTM__IFT — BTM__25FT	Battery Module Fault	YES, NO
CCNT	Number of Continuous DTCs in Module	Integer Value
CHG__ABD	Charger Charging After Being Disabled	YES, NO
CHG__CAP	Charging Capacity	% (Percent)
CHG__CCF	Charger Cord Circuit Fault	YES, NO
CHG__CO	Charger Contactor Output Status	ENABLE, DISABLE
CHG__COF	Charger Contactor Output Fault	YES, NO
CHG__CYC	Charge Cycles	Integer Value
CHG__CYF	Charger Cycling Fault	YES, NO
CHG__LCF	Charger Line Capacity Fault	YES, NO
CHG__LUF	Charger Latch-Up Fault	YES, NO
CHG__LVL	Charging Level Output Status	% (Percent)
CHG__MFF	Charger Mode Feedback Fault	YES, NO
CHG__OAF	Charger Over Amp-Hours Fault	YES, NO
CHG__OCF	Charger Over Current Fault	YES, NO
CHG__OTF	Charger Over-Temperature Fault	YES, NO
CHG__OVF	Charger Over Voltage Fault	YES, NO
CHG__UCF	Charger Under Current Fault	YES, NO
CHGCHGR	Charger Charging Input Status	YES, NO
CHGCORD	Charger Cord Input Status	IN, OUT
CHGFLT	Charger Fault Input Status	YES, NO
CHGMAX	Charger Max Line Input Status	ENABLE, DISABLE
CHGMODE	Charger Mode Output Status	CURRENT, VOLTAGE
CHGOUT	Charger Output Status	ENABLE, DISABLE
CHGPLT	Charger Pilot Output Status	ENABLE, DISABLE
CHGPWR	Charger Power Output Status	ENABLE, DISABLE
CHGRDY	Charger Ready Input Status	YES, NO
CUR__SEN	Current Sense Control	ENABLE, DISABLE
CUS__SOC	Customer State of Charge (SOC)	% (Percent)

(Continued)

**DIAGNOSIS AND TESTING (Continued)****Battery Control Module (BCM) Parameter Identification (PID) Index —NiMH**

<b>PID</b>	<b>Description</b>	<b>Expected Values</b>
D__TIME	Total Drive Time	SEC (Seconds)
EMG__PO	Emergency Power Off Input Status	ENABLE, DISABLE
FAN__FL	Flow Through Fan Power	ENABLE, DISABLE
FAN__RE	Recirculation Fan Power	ENABLE, DISABLE
FANFDBK	Recirculation Fan Feedback	ENABLE, DISABLE
FLOW__F	Flow Through Fan Fault	YES, NO
FLOWFBK	Flow Through Fan Feedback	ENABLE, DISABLE
IGN__R	Ignition Switch - Run Position	YES, NO
IOMH__F	IOM to BCM Diagnostic Input Stuck High Fault	YES, NO
IOML__F	IOM to BCM Diagnostic Input Stuck Low Fault	YES, NO
IOMP__F	IOM Diagnostic Fault/Pilot Not Disabled Fault	YES, NO
LEAK__CF	Leakage Circuit Failure	YES, NO
LEAK__DF	Leakage During Drive Fault	YES, NO
LEAK__ID	Battery Pack Leakage Module Identification	Integer Value
LEAKHCF	High Level Leakage During Charge Fault	YES, NO
LEAKLCF	Low Level Leakage During Charge Fault	YES, NO
LEAKRES	Parallel Combination of Bus Leakage Resistance	OHM
LKRESB+	Leakage Resistance (Bus +)	OHM
LKRESB-	Leakage Resistance (Bus -)	OHM
LOWVOLT	Low Voltage Flags	Integer Value
MAINSEN	Main Sensor Voltage	V (Volts)
MAXTCHG	Maximum Temperature Change	°C, °F
MAXTEMP	Maximum Temperature	°C, °F
MINTEMP	Minimum Temperature	°C, °F
NMBICO	Negative Main Bus Inhibit Contactor Output Status	ENABLE, DISABLE
NMBICOF	Negative Main Bus Inhibit Contactor Output Fault	YES, NO
PREV__OS	Previous ECU Operating State	Integer Value (Refer to Battery Control Module Operating State Index for a detailed description of integer value.)
RECIR__F	Recirculation Fan Fault	YES, NO
REV__BAT	Reverse Battery Module Installed	YES, NO
SOC	State of Charge	% (Percent)
TMPSEN1	Temperature Sensor 1	°C, °F
TMPSEN2	Temperature Sensor 2	°C, °F
TMPSEN3	Temperature Sensor 3	°C, °F
TMPSEN4	Temperature Sensor 4	°C, °F
TPMCOF	Traction Battery Main Contactor Output Fault	YES, NO

(Continued)

**DIAGNOSIS AND TESTING (Continued)****Battery Control Module (BCM) Parameter Identification (PID) Index —NiMH**

PID	Description	Expected Values
TRAC_MC	Traction Main Current	AMP
TRANSGR	Transmission Gear	D6_PRK, notPRK
WRG_BCM	Wrong BCM Hardware Installed	YES, NO

**Operating State Indices****Interface Adapter Assembly (IAA) Module Operating State Index****Interface Adapter Assembly (IAA) Module Operating State Index**

Operating State	State Description
0	Module Off
3	Wakeup
7	Run Mode (Drive)
11	Pre-Limited Operating Strategy (LOS) 3
12	LOS 3 (EPO State)
13	Pre-LOS 4
14	LOS 4 (Under Voltage)
15	Key Off/Off Plug
16	Diagnostic Mode
22	Power-On Reset
24	Key In Run and Plugged In
25	Plugged In
26	Over-Voltage Shutdown
27	Over-Voltage Idle
28	Over-Voltage Recovery
30	Sleep
32	Power On Self Test (POST) Failed

**Traction Inverter Module (TIM) Operating State Index****Traction Inverter Module (TIM) Operating State Index**

Operating State	State Description
0	Module Off
16	Diagnostic Mode
17	Initialization
18	Precharge
19	Drive
20	Shutdown
21	Powerdown

(Continued)

**Traction Inverter Module (TIM) Operating State Index**

Operating State	State Description
34	TIM LOS Mode 2 <sup>a</sup>
45	TIM LOS Mode 13 <sup>b</sup>
47	TIM LOS Mode 15 <sup>c</sup>

- a If TIM is in this state and the motor temp and TIM heat sink temp are within the proper range this fault is a temporary fault caused by a gate drive fault.
- b This indicates a configuration fault, Postal Ranger EV versus Ranger EV.
- c This indicates a combination of LOS 2 and LOS 13 faults.

**Battery Control Module (BCM) Operating State Index —Lead Acid****Battery Control Module (BCM) Operating State Index —Lead Acid**

Operating State	State Description
0	Module Off
1	Zeroing Current Sensors
2	Vehicle Idle
3	Wakeup
4	Charge Setup
5	Charge (Current Mode)
6	Charge (Voltage Mode)
7	Run Mode (Drive)
8	Housekeeping
9	Auxiliary Battery Voltage Out of Range
16	Diagnostic Mode
48	Shutdown-Low Battery Module Voltage
49	Shutdown-Low SOC
50	Shutdown-Battery Reversed
51	No Start-Battery Under Temperature
52	No Start-Wrong BCM Hardware Installed
53	Shutdown-12V Battery Module Installed In 8V Battery Pack

(Continued)

**DIAGNOSIS AND TESTING (Continued)****Battery Control Module (BCM) Operating State Index —Lead Acid**

Operating State	State Description
64	LOS Drive-Current Sense Fault
65	LOS Drive-Voltage Sense Fault
66	LOS Drive-Temperature Sensor Fault
67	LOS Drive-Battery Over Temperature
68	LOS Drive-Battery Under Temperature
69	LOS Drive-Low SOC
80	No Charge-Overvoltage
81	No Charge-Excessive Amp-Hours
82	No Charge-Auxiliary Current Sense Fault
83	No Charge-Battery Over Temperature
84	No Charge-Battery Under Temperature
85	No Charge-High Temperature Delta
86	No Charge-Temperature Sense Fault
87	No Charge-Battery Full
88	No Charge-Undercurrent Fault
89	No Charge-Overcurrent Fault
90	No Charge-Vent Fan Fault
91	No Charge-Voltage Sense Fault
92	No Charge-Line Capacity Fault
93	No Charge-Charger Charging After Disable
94	No Charge-Charger Cycling Fault
95	No Charge-Charger Mode Signal Disconnected
96	No Charge-EPO Detected
97	No Charge-Not in PARK
98	No Charge-Leakage Impedance Low
99	No Charge-Line Capacity Out of Range
100	No Charge-Release Safety Pilot Command Received
101	No Charge-No AC to Charger
102	No Charge-Charger Over Temperature
103	No Charge-Charger Latchup
104	No Charge-No Stored Code Logging (NSCL)

(Continued)

**Battery Control Module (BCM) Operating State Index —Lead Acid**

Operating State	State Description
105	No Charge-Battery Installed in Reverse
106	No Charge-Negative Contactor Relay Welded/Stuck Closed
107	No Charge-TIM SCP Message: Main Contactor Relay Welded/Stuck Closed
108	No Charge-Wrong BCM Hardware Installed
109	No Charge-12V Battery Module Installed in 8V Battery Pack
112	LOS Charge-High Battery Temperature
113	LOS Charge-Temperature Sensor Fault
114	LOS Charge-Low Battery Voltage

**Battery Control Module (BCM) Operating State Index —NiMH****Battery Control Module (BCM) Operating State Index —NiMH**

Operating State	State Description
0	Module Off
1	Zeroing Current Sensors
2	Vehicle Idle
3	Wakeup
4	Charge Setup
5	Charge (Current Mode)
6	Charge (Voltage Mode)
7	Run Mode (Drive)
8	Housekeeping
9	Auxiliary Battery Voltage Out of Range
16	Diagnostic Mode
48	Shutdown-Low Battery Module Voltage
49	Shutdown-Low SOC
50	Shutdown-Battery Reversed
51	No Start-Battery Under Temperature
52	No Start-Wrong BCM Hardware Installed
54	Shutdown-Battery Over Temperature

(Continued)



**DIAGNOSIS AND TESTING (Continued)****Battery Control Module (BCM) Operating State Index —NIMH**

Operating State	State Description
55	Shutdown-Battery Module Voltage Out of Balance
64	LOS Drive-Current Sense Fault
65	LOS Drive-Voltage Sense Fault
66	LOS Drive-Temperature Sensor Fault
67	LOS Drive-Battery Over Temperature
68	LOS Drive-Battery Under Temperature
69	LOS Drive-Low SOC
70	LOS Drive-Battery Module Voltage Out of Balance
80	No Charge-Overvoltage
81	No Charge-Excessive Amp-Hours
82	No Charge-Auxiliary Current Sense Fault
83	No Charge-Battery Over Temperature
84	No Charge-Battery Under Temperature
85	No Charge-High Temperature Delta
86	No Charge-Temperature Sense Fault
87	No Charge-Battery Full
88	No Charge-Undercurrent Fault
89	No Charge-Overcurrent Fault
90	No Charge-Vent Fan Fault
91	No Charge-Voltage Sense Fault
92	No Charge-Line Capacity Fault
93	No Charge-Charger Charging After Disable
94	No Charge-Charger Cycling Fault
95	No Charge-Charger Mode Signal Disconnected
96	No Charge-EPO Detected
97	No Charge-Not in PARK
98	No Charge-Leakage Impedance Low
99	No Charge-Line Capacity Out of Range
100	No Charge-Release Safety Pilot Command Received
101	No Charge-No AC to Charger
102	No Charge-Charger Over Temperature

(Continued)

**Battery Control Module (BCM) Operating State Index —NIMH**

Operating State	State Description
103	No Charge-Charger Latchup
104	No Charge-No Stored Code Logging (NSCL)
105	No Charge-Battery Installed in Reverse
106	No Charge-Negative Contactor Relay Welded/Stuck Closed
107	No Charge-TIM SCP Message: Main Contactor Relay Welded/Stuck Closed
108	No Charge-Wrong BCM Hardware Installed
110	No Charge-IOM Fault
112	LOS Charge-High Battery Temperature
113	LOS Charge-Temperature Sensor Fault
114	LOS Charge-Low Battery Voltage
115	LOS Charge-Voltage Sense Fault
116	LOS Charge-Recirculation Fan Inoperative
117	LOS Charge-Flow Trough Fan Inoperative
118	LOS Charge-Battery Under Temperature

**Active Command Indices****Interface Adapter Assembly (IAA) Module Active Command Index****Interface Adapter Assembly (IAA) Module Active Command Index**

Active Command	Active Command Mode	Signal
CONT	Continuous Blend Door Movement	PWM (%)
BAT SOC	Battery State of Charge	PWM (%)
ECON_G	Economy Gauge	PWM (%)
DTE_G	Distance to Empty Gauge	PWM (%)
TEMP_G	Temperature Gauge	PWM (%)
RESET	Parameter Reset Command	LDATA

(Continued)

**DIAGNOSIS AND TESTING (Continued)****Interface Adapter Assembly (IAA) Module Active Command Index**

Active Command	Active Command Mode	Signal
RECIRC	Recirculation Door Control	STOP, RECIRC, FRESH
FAN SPD	Fan Speed Control	STOP, LOW, HIGH
HTR PWR	Temperature Control Command	ON, OFF
HTR A	Temperature Control Command	ON, OFF
HTR B	Temperature Control Command	ON, OFF
A/C COMP	Temperature Control Command	ON, OFF
RECIR LED	Temperature Control Command	ON, OFF
BRK LAMP	Indicator Lamp Control	ON, OFF
ECON MODE	Indicator Lamp Control	ON, OFF
FUEL LOW	Indicator Lamp Control II	ON, OFF
CHARGE	Indicator Lamp Control III	ON, OFF
LOW LUBE	Indicator Lamp Control III	ON, OFF
MIL	Indicator Lamp Control III	ON, OFF
ENG RESET	Indicator Lamp Control III	ON, OFF
BATTERY	Indicator Lamp Control III	ON, OFF
HAZARD	Indicator Lamp Control III	ON, OFF
PWR LIMIT	Indicator Lamp Control III	ON, OFF
PUMP/VBC	Climate System Control	ON, OFF
VAC RLY	Climate System Control	ON, OFF
GAUGE PWR	Instrumentation Control	ON, OFF
MOTOR ENA	Instrumentation Control	ON, OFF
VAC RLY	Thermal Regulation Output Control	ON, OFF

(Continued)

**Interface Adapter Assembly (IAA) Module Active Command Index**

Active Command	Active Command Mode	Signal
A/C DC	Climate Control Command	PWM (%)
BLEND DR	Climate Control Command	PWM (%)
SUPPT SLI	Climate Control Command	YES, NO
MAINT VAC	Climate Control Command	YES, NO
COOLANT P	Climate Control Command	ON, OFF
AUX CONT	Climate Control Command	OPEN, CLOSE
VBC RELAY	Climate Control Command	OPEN, CLOSE
BLOWER	Climate Control Command	OFF, LOW, MEDLO, MEDHI, HIGH
HTR PWR	Climate Control Command	ON, OFF
HTR A	Climate Control Command	ON, OFF
HTR B	Climate Control Command	ON, OFF
A/C PWR	Climate Control Command	ON, OFF
RECIR SOL	Climate Control Command	ON, OFF
CONDENSER	Climate Control Command	OFF, LOW, HIGH
SUPPT SLI	Auxiliary System Control	YES, NO
MAINT VAC	Auxiliary System Control	YES, NO
AUX CONT	Auxiliary System Control	OPEN, CLOSE
DC/DC CNV	Auxiliary System Control	ENABLE, DISABLE
VAC PUMP	Auxiliary System Control	ON, OFF
PWR STEER	Auxiliary System Control	ON, OFF
RADIATOR	Auxiliary System Control	OFF, LOW, HIGH

**DIAGNOSIS AND TESTING (Continued)****Traction Inverter Module (TIM) Active Command Index****Traction Inverter Module (TIM) Active Command Index**

Active Command	Active Command Mode	Signal
SPDOMETER	Speedometer Control	PWM (%)
POS MAIN	Contactora Output Control	OPEN, CLOSE
PRECHG IN	Contactora Output Control	OPEN, CLOSE
PUMP	Fluid Control	ENABLE, DISABLE

**Battery Control Module (BCM) Active Command Index —Lead Acid****Battery Control Module (BCM) Active Command Index —Lead Acid**

Active Command	Active Command Mode	Signal
CHG LEVEL	Charging Level Control	PWM (%)
FAN SPEED	Fan Speed Control	PWM (%)
RESET	Parameter Reset Command	LDATA
BATTERY #	Battery Module Select	1-39
RESET	Reset Historical Data	1-39, SOC, ALL
FAN PWR	Thermal Regulation Output Control	ENABLE, DISABLE
BAT HTR 1	Thermal Regulation Output Control	ENABLE, DISABLE
BAT HTR 2	Thermal Regulation Output Control	ENABLE, DISABLE
CHG PWR	Charging System Output Control	ENABLE, DISABLE
CHG PILOT	Charging System Output Control	ENABLE, DISABLE
CHG MODE	Charging System Output Control	VOLT, CURR
CHARGER	Charging System Output Control	ENABLE, DISABLE
NEG MAIN	Contactora Output Control	OPEN, CLOSE
CHARGER	Contactora Output Control	OPEN, CLOSE
CHG LVL	BCM Packeted Commands	PWM (%)

(Continued)

**Battery Control Module (BCM) Active Command Index —Lead Acid**

Active Command	Active Command Mode	Signal
FAN SPEED	BCM Packeted Commands	PWM (%)
NEG MAIN	BCM Packeted Commands	OPEN, CLOSE
CHARGER C	BCM Packeted Commands	OPEN, CLOSE
CHG PWR	BCM Packeted Commands	ENABLE, DISABLE
CHG PILOT	BCM Packeted Commands	ENABLE, DISABLE
CHG MODE	BCM Packeted Commands	VOLT, CURR
CHARGER E	BCM Packeted Commands	ENABLE, DISABLE
CURRENT S	BCM Packeted Commands	ENABLE, DISABLE
BLOWER P	BCM Packeted Commands	ENABLE, DISABLE
BAT HTR 1	BCM Packeted Commands	ENABLE, DISABLE
BAT HTR2	BCM Packeted Commands	ENABLE, DISABLE

**Battery Control Module (BCM) Active Command Index —NiMH****Battery Control Module (BCM) Active Command Index —NiMH**

Active Command	Active Command Mode	Signal
CHG LEVEL	Charging Level Control	PWM (%)
FAN SPEED	Fan Speed Control	PWM (%)
RESET	Parameter Reset Command	LDATA
BATTERY #	Battery Module Select	1-25
RESET	Reset Historical Data	1-25, SOC, ALL
FAN_FL	Thermal Regulation Output Control	ENABLE, DISABLE
FAN_RE	Thermal Regulation Output Control	ENABLE, DISABLE
CHG PWR	Charging System Output Control	ENABLE, DISABLE
CHG PILOT	Charging System Output Control	ENABLE, DISABLE

(Continued)

## DIAGNOSIS AND TESTING (Continued)

### Battery Control Module (BCM) Active Command Index —NiMH

Active Command	Active Command Mode	Signal
CHG MODE	Charging System Output Control	VOLT, CURR
CHARGER	Charging System Output Control	ON, OFF
NEG MAIN	Contactora Output Control	OPEN, CLOSE
CHARGER	Contactora Output Control	OPEN, CLOSE
CHG LVL	BCM Packeted Commands	PWM (%)
NEG MAIN	BCM Packeted Commands	OPEN, CLOSE
CHARGER C	BCM Packeted Commands	OPEN, CLOSE
CHG PWR	BCM Packeted Commands	ENABLE, DISABLE
CHG PILOT	BCM Packeted Commands	ENABLE, DISABLE
CHG MODE	BCM Packeted Commands	VOLT, CURR
CHARGER E	BCM Packeted Commands	ENABLE, DISABLE
CURRENT S	BCM Packeted Commands	ENABLE, DISABLE
FAN__RE	BCM Packeted Commands	ENABLE, DISABLE
FAN__FL	BCM Packeted Commands	ENABLE, DISABLE

## Miscellaneous Diagnostics

### Diagnostic Trouble Code (DTC) Definition

The following DTCs relate to the interface adapter assembly (IAA) module:

- DTC B1342 ECU Is Defective
  - The interface adapter assembly (IAA) module carries out an internal self-test when the ignition key is turned to the ON position. The IAA module sets DTC B1342 if it does not pass its self-test at key ON.

- DTC B1555 Ignition Run/Start - Circuit Failure
  - The interface adapter assembly (IAA) module uses the key RUN/START input at pin 97 to begin control of all the vehicle system functions for which it is responsible. The IAA module sets DTC B1555 if it does not detect the key RUN/START input within two seconds of receiving a message from the traction inverter module (TIM).

The following DTC relates to the traction inverter module (TIM):

- DTC B2477 Module Configuration Failure
  - The TIM supports the downloading of new software for module updates. The TIM sets DTC B2477 if a software update is attempted and is not successful.

The following DTC relates to the battery control module (BCM):

- DTC B2477 Module Configuration Failure
  - The BCM supports the downloading of new software for module updates. The BCM sets DTC B2477 if a software update is attempted and is not successful. The BCM also sets DTC B2477 in conjunction with DTC B1342 ECU Is Defective if its read-only memory (ROM) or random-access memory (RAM) has failed the BCM self-test.

### Electrical Schematic

Refer to Electrical and Vacuum Troubleshooting Manual, Cell 13, Power Distribution (Low Voltage) for schematic and connector information.

**DIAGNOSIS AND TESTING (Continued)****Symptom Chart****Symptom Chart**

Condition	Possible Sources	Action
<ul style="list-style-type: none"> <li>DTC B1342 ECU Is Defective (IAA Module)</li> </ul>	<ul style="list-style-type: none"> <li>Interface adapter assembly (IAA) module.</li> </ul>	<ul style="list-style-type: none"> <li>GO to Pinpoint Test A.</li> </ul>
<ul style="list-style-type: none"> <li>DTC B1555 Ignition Run/Start - Circuit Failure</li> </ul>	<ul style="list-style-type: none"> <li>Fuse.</li> <li>Circuit.</li> <li>Interface adapter assembly (IAA) module.</li> </ul>	<ul style="list-style-type: none"> <li>GO to Pinpoint Test B.</li> </ul>
<ul style="list-style-type: none"> <li>DTC B2477 Module Configuration Failure</li> </ul>	<ul style="list-style-type: none"> <li>Traction inverter module (TIM).</li> <li>Battery control module (BCM).</li> </ul>	<ul style="list-style-type: none"> <li>GO to Pinpoint Test C.</li> </ul>

**Pinpoint Tests****Special Tool(s)**

104-Pin Breakout Box (BOB) 418-049 (014-00950) or equivalent
--

**PINPOINT TEST A : DTC B1342 ECU IS DEFECTIVE (IAA MODULE)**

TEST STEP	ACTION TO TAKE
<b>A1 CHECK INTERFACE ADAPTER ASSEMBLY (IAA) MODULE OPSTATE PID</b> <ul style="list-style-type: none"> <li>With key ON, monitor the IAA module PID OPSTATE.</li> <li><b>Does the OPSTATE PID indicate 32 (Power On Self-Test Failed)?</b></li> </ul>	Yes = REPLACE the IAA module. REFER to <a href="#">Section 412-04</a> . No = GO to <b>A2</b> .
<b>A2 PERFORM ON-DEMAND SELF-TEST</b> <ul style="list-style-type: none"> <li>Perform the On-Demand Self-Test for the IAA module.</li> <li><b>Does DTC B1342 occur?</b></li> </ul>	Yes = REPLACE the IAA module. REFER to <a href="#">Section 412-04</a> . No = System OK. CLEAR the DTCs from the IAA module's continuous memory.

**PINPOINT TEST B: DTC B1555 IGNITION RUN/START - CIRCUIT FAILURE**

TEST STEP	ACTION TO TAKE
<b>B1 CHECK FUSE</b> <ul style="list-style-type: none"> <li>Check 15A fuse 19 in the I/P fuse panel.</li> <li><b>Is the fuse OK?</b></li> </ul>	Yes = GO to <b>B2</b> . No = REPLACE the fuse. If the fuse fails again, CHECK/REPAIR for a short to ground.
<b>B2 CHECK POWER (KEY RUN SIGNAL) TO INTERFACE ADAPTER ASSEMBLY (IAA) MODULE</b> <ul style="list-style-type: none"> <li>Connect 104-Pin Breakout Box (BOB) to IAA module C1945; leave IAA module disconnected.</li> <li>With key ON, measure the voltage between BOB pin 97 and ground (BOB pin 80).</li> <li><b>Is the voltage greater than 10 volts?</b></li> </ul>	Yes = REPLACE the IAA module. REFER to <a href="#">Section 412-04</a> . No = REPAIR circuit 295 (LB/PK wire).

**DIAGNOSIS AND TESTING (Continued)****PINPOINT TEST C : DTC B2477 MODULE CONFIGURATION FAILURE**

TEST STEP	ACTION TO TAKE
<p><b>C1 CARRY OUT SOFTWARE DOWNLOAD</b></p> <p><b>NOTE:</b> If the battery control module (BCM) sets DTC B2477, check the traction battery support tray in-line C1939 for secure connection.</p> <ul style="list-style-type: none"> <li>• Verify all connections to the module in question are secure and the New Generation STAR (NGS) Tester is securely connected to data link connector (DLC) C209.</li> <li>• Clear the diagnostic trouble codes (DTCs) from the module.</li> </ul> <p><b>NOTE:</b> Do not turn the ignition key to the OFF position, disconnect any connectors, or press the CANCEL button on the NGS Tester while downloading the software.</p> <ul style="list-style-type: none"> <li>• Retry downloading the new software.</li> <li>• Retrieve DTCs from the module.</li> <li>• <b>Does DTC B2477 reoccur?</b></li> </ul>	<p>Yes =     RETRY the software download procedure. If DTC B2477 keeps occurring, REPLACE the module. REFER to <a href="#">Section 303-14 (TIM)</a> or <a href="#">Section 414-03A (BCM)</a>.</p> <p>No =       System OK. CLEAR the DTCs from the module's continuous memory.</p>

[Manual Table of Contents](#)

# SECTION 100-09 Powertrain Diagnostic Routines Identification

VEHICLE APPLICATION: Ranger EV

CONTENTS	PAGE
<b>DIAGNOSIS AND TESTING</b>	
Powertrain Diagnostic Routines Identification .....	100-09-2
Diagnostic Preface .....	100-09-2
Diagnostic Routines .....	100-09-3
Directions .....	100-09-2
Powertrain Diagnostic Routines Index .....	100-09-2

## DIAGNOSIS AND TESTING

### Powertrain Diagnostic Routines Identification

#### Diagnostic Preface

The diagnostic routines are based on symptom related vehicle operation and performance concerns. The diagnostic routines are to be carried out when a vehicle driveability or traction battery charging concern exists and no diagnostic trouble codes (DTCs) occur when the Diagnostic Process is carried out. Refer to [Section 100-07](#) for information regarding the Diagnostic Process.

The diagnostic routines list, in test step form, the systems that can contribute to a particular condition in order of probability, ease of accomplishment, and accessibility. These routines can be used as check lists for reference in the event of unusual or infrequent causes of a malfunction.

#### Directions

When performing the diagnostic routines, adhere to the following steps:

1. Unless a fault is evident, it is recommended that all diagnosis begin with a thorough visual inspection of a suspected system or component.
2. If an obvious cause for an observed or reported malfunction can be found, correct the cause of the malfunction before proceeding to the next step.
3. If the cause of a malfunction cannot be found by visual inspection, proceed to Powertrain Diagnostic Routines Index.
4. After each repair is made, check to see if symptom(s) are still present.
5. After all repairs are made, verify vehicle operation as follows:
  - Carry out the Diagnostic Process. Refer to [Section 100-07](#).
  - Test drive the vehicle. Check for driveability symptoms, abnormal vehicle performance, and illumination of instrument cluster indicator lamps.

### Powertrain Diagnostic Routines Index

#### Driveability and Traction Battery Charging

Concern	Condition	Routine Number
• Starting Concerns	• Vehicle Does Not Start (Lead Acid Vehicles)	1
	• Vehicle Does Not Start (NiMH Vehicles)	2
	• Vehicle Starts, But Does Not Move	3
• Performance While Driving Concerns	• Vehicle Quits While Driving (Lead Acid Vehicles)	1
	• Vehicle Quits While Driving (NiMH Vehicles)	2
	• Vehicle Operates at Reduced Power (Lead Acid Vehicles)	4
	• Vehicle Operates at Reduced Power (NiMH Vehicles)	5
	• Noticeable Decrease in Vehicle Driving Range (Lead Acid Vehicles)	6
• Vehicle Charging Concerns	• Noticeable Decrease in Vehicle Driving Range (NiMH Vehicles)	7
	• Vehicle Does Not Charge (Lead Acid Vehicles)	8
	• Vehicle Does Not Charge (NiMH Vehicles)	9
	• Vehicle Charging Takes Longer Than Normal to Reach Full State of Charge (SOC) (Lead Acid Vehicles)	10
	• Vehicle Charging Takes Longer Than Normal to Reach Full State of Charge (SOC) (NiMH Vehicles)	11
	• Coolant Pump and DC/DC Converter Operate When Power Control Station (PCS) Is Disconnected From the Charger Inlet Connector	12



**DIAGNOSIS AND TESTING (Continued)****Diagnostic Routines****Special Tool(s)**

104-Pin Breakout Box (BOB) 418-049 (014-00950) or equivalent
BCM/TIM Breakout Box (BOB) Adapter Cable 418-F212
BCM/TIM Breakout Box (BOB) Overlay 418-F220
Traction Battery High Voltage Service Cord 418-F218

(Continued)

**Special Tool(s)**

Traction Battery Low Voltage Service Cord 418-F219
Traction Battery High-Voltage Lockout and Diagnostic Tool 418-F207
High-Voltage Insulated Safety Gloves 100-F036 or equivalent
Face Shield 100-F035 or equivalent
Electric Motor/Transaxle Test Box 418-F211

**ROUTINE 1: VEHICLE DOES NOT START/VEHICLE QUILTS WHILE DRIVING (LEAD ACID VEHICLES)**

TEST STEP	ACTION TO TAKE
<b>1-1 CHECK AUXILIARY BATTERY VOLTAGE</b> <ul style="list-style-type: none"> <li>With key OFF, measure the voltage of the 12-volt auxiliary battery.</li> <li><b>Is the voltage greater than 11.5 volts?</b></li> </ul>	Yes = GO to <b>1-2</b> . No = CARRY OUT the Auxiliary Battery Capacity Test. REFER to <a href="#">Section 414-02</a> .
<b>1-2 CHECK STATUS OF BATTERY CONTROL MODULE (BCM) OPERATING STATE</b> <ul style="list-style-type: none"> <li>With key ON, monitor BCM PID BCM__OP.</li> <li><b>Does the BCM__OP PID indicate 48 (shutdown-low battery module voltage), 49 (shutdown-low SOC), or 51 (no start-battery under temperature)?</b></li> </ul>	Yes = If BCM__OP PID indicates 48, GO to <b>1-3</b> . If BCM__OP PID indicates 49, CHARGE the traction battery. REFER to <a href="#">Section 100-05</a> . If BCM__OP PID indicates 51, GO to <b>1-6</b> . No = GO to <b>1-10</b> .
<b>1-3 CHARGE TRACTION BATTERY TO FULL STATE OF CHARGE (SOC)</b> <ul style="list-style-type: none"> <li>Disconnect and reconnect the 12-volt auxiliary battery negative cable.</li> <li>Charge the traction battery to full SOC.</li> <li>With key ON, monitor BCM PID BCM__OP.</li> <li><b>Does the BCM__OP PID still indicate 48 (shutdown-low battery module voltage)?</b></li> </ul>	Yes = GO to <b>1-4</b> . No = System OK.
<b>1-4 CHECK STATUS OF TRACTION BATTERY MODULES BY CARRYING OUT THE BATTERY MODULE DIAGNOSTIC TEST</b> <ul style="list-style-type: none"> <li>With key ON, carry out the Battery Module Diagnostic Test. Refer to the procedure in Traction Battery System <a href="#">Section 414-03A</a>.</li> <li><b>Does the Battery Module Diagnostic Test indicate to replace any battery modules?</b></li> </ul>	Yes = GO to <b>1-5</b> . No = CHARGE the traction battery to full SOC. CHECK the BCM__OP PID. If the BCM__OP PID still indicates 48, REPLACE the BCM. REFER to <a href="#">Section 414-03A</a> .
<b>1-5 INPUT BATTERY MODULE DATA</b>	

(Continued)

**DIAGNOSIS AND TESTING (Continued)****ROUTINE 1: VEHICLE DOES NOT START/VEHICLE QUILTS WHILE DRIVING (LEAD ACID VEHICLES)**

TEST STEP	ACTION TO TAKE
<ul style="list-style-type: none"> <li>With key ON, monitor BCM PIDs BAT__INT, BAT__MC, CHG__CYC, and LOWVOLT, and enter the values on the Dealer Battery Return Form that is packaged with the cycled service (battery) module.</li> <li>Fill out all the required data on the Dealer Battery Return Form and return the form with the damaged battery module to the supplier.</li> <li><b>Is the correct data entered on the Dealer Battery Return Form?</b></li> </ul>	<p>Yes = REPLACE the battery module(s) in question. REFER to <a href="#">Section 414-03A</a>.</p> <p>No = ENTER the indicated data. REPLACE the battery module(s) in question. REFER to <a href="#">Section 414-03A</a>.</p>
<p><b>1-6 CHECK TRACTION BATTERY TEMPERATURE SENSORS FOR UNDERTEMPERATURE CONDITION</b></p> <ul style="list-style-type: none"> <li>With key ON, monitor BCM PIDs TMPSEN1, TMPSEN2, TMPSEN3, and TMPSEN4.</li> <li><b>Do any of the TMPSEN PIDs indicate less than -20°C (-4°F)?</b></li> </ul>	<p>Yes = GO to <b>1-7</b>.</p> <p>If all TMPSEN PIDs are less than -20°C (-4°F), PARK the vehicle indoors and if the vehicle is equipped with traction battery heaters, CONNECT it to the power control station (PCS) to warm the traction battery to a temperature greater than -15°C (5°F).</p> <p>No = DISCONNECT and RECONNECT the 12-volt auxiliary battery negative cable and RECHECK the BCM__OP PID. If the BCM__OP PID still indicates 51, REPLACE the BCM. REFER to <a href="#">Section 414-03A</a>.</p>
<p><b>1-7 IDENTIFY VEHICLE OPTION</b></p> <ul style="list-style-type: none"> <li>Determine if the vehicle is equipped with traction battery heaters.</li> <li><b>Is the vehicle equipped with traction battery heaters?</b></li> </ul>	<p>Yes = GO to <b>1-8</b>.</p> <p>No = GO to <b>1-9</b>.</p>
<p><b>1-8 CHECK TEMPERATURE DIFFERENCE BETWEEN BATTERY TEMPERATURE SENSORS</b></p> <ul style="list-style-type: none"> <li>With key ON, monitor BCM PIDs TMPSEN1, TMPSEN2, TMPSEN3, and TMPSEN4.</li> <li><b>Is there a temperature difference of greater than 7°C (13°F) between the temperature sensor that is below -20°C (-4°F) and the other temperature sensors?</b></li> </ul>	<p>Yes = GO to <b>1-9</b>.</p> <p>No = CONNECT the vehicle to the power control station (PCS) to warm the traction battery to a temperature greater than -15°C (5°F). MONITOR the TMPSEN PIDs while the vehicle is connected to the PCS. If the temperature of the battery temperature sensor that was less than -20°C (-4°F) does not increase, GO to <b>1-9</b>.</p>
<p><b>1-9 CHECK BATTERY TEMPERATURE SENSOR</b></p>	

(Continued)

**DIAGNOSIS AND TESTING (Continued)****ROUTINE 1: VEHICLE DOES NOT START/VEHICLE QUILTS WHILE DRIVING (LEAD ACID VEHICLES)**

TEST STEP	ACTION TO TAKE
<ul style="list-style-type: none"> <li>• Remove the traction battery and connect Traction Battery High-Voltage Lockout and Diagnostic Tool to the traction battery high-voltage two-pin C3994M.</li> </ul> <p><b>⚠ WARNING: The traction battery contains high-voltage components and wiring. High-voltage insulated safety gloves and face shield must be worn when carrying out the following steps. Failure to follow this warning may result in severe personal injury or death.</b></p> <ul style="list-style-type: none"> <li>• Connect Traction Battery High Voltage Service Cord to traction battery support tray in-line C1935F and in-line C1935M.</li> <li>• Connect Traction Battery Low Voltage Service Cord to traction battery support tray in-line C1939F and in-line C1939M.</li> <li>• With key OFF, disconnect the battery temperature sensor in question and one of the other temperature sensors.</li> <li>• Connect jumper wires between the connector for the temperature sensor in question and the known good temperature sensor that was disconnected.</li> <li>• With key ON, monitor BCM PIDs TMPSEN1, TMPSEN2, TMPSEN3, and TMPSEN4.</li> <li>• <b>Does the TMPSEN PID that indicated less than -20°C (-4°F) still indicate -20°C (-4°F)?</b></li> </ul>	<p>Yes = REPLACE the BCM. REFER to <a href="#">Section 414-03A</a>.</p> <p>No = REPLACE the battery temperature sensor in question.</p>
<p><b>1-10 CHECK STATUS OF KEY START SIGNAL TO TRACTION INVERTER MODULE (TIM)</b></p> <ul style="list-style-type: none"> <li>• With key ON, monitor TIM PID IGN__S.</li> <li>• Turn the ignition key to the START position.</li> <li>• <b>Does the IGN__S PID indicate YES when the ignition key is turned to the START position?</b></li> </ul>	<p>Yes = GO to <b>1-13</b>.</p> <p>No = GO to <b>1-11</b>.</p>
<p><b>1-11 CHECK FUSE (HOT IN START) TO TIM</b></p> <ul style="list-style-type: none"> <li>• Check 7.5A fuse 24, 10A fuse 9 and 7.5A fuse 11 in the I/P fuse panel.</li> <li>• <b>Is the fuse OK?</b></li> </ul>	<p>Yes = GO to <b>1-12</b>.</p> <p>No = REPLACE the fuse. If the fuse fails again, CHECK/REPAIR for a short to ground, or TIM internal failure.</p>
<p><b>1-12 CHECK KEY START SIGNAL TO TIM</b></p> <ul style="list-style-type: none"> <li>• Connect 104-Pin Breakout Box (BOB) to TIM C4998, C4999 using the BCM/TIM BOB Adapter Cable &amp; Overlay; leave the TIM disconnected.</li> <li>• Connect a multimeter between BOB pins B8 and A29.</li> <li>• Turn the ignition key to the START position.</li> <li>• <b>Is the voltage greater than 10 volts when the ignition key is turned to the key START position?</b></li> </ul>	<p>Yes = REPLACE the TIM. REFER to <a href="#">Section 303-14</a>.</p> <p>No = REPAIR the W/BK wire between pin 8 on TIM C4999 and the I/P fuse panel.</p>
<p><b>1-13 CHECK EMERGENCY POWER OFF (EPO) STATUS TO TIM</b></p> <ul style="list-style-type: none"> <li>• With key ON, monitor TIM PID EMG__PO.</li> <li>• <b>Does the EMG__PO PID indicate ENABLE?</b></li> </ul>	<p>Yes = GO to <b>1-14</b>.</p> <p>No = GO to <b>1-19</b>.</p>
<p><b>1-14 CHECK EPO SIGNAL TO TIM</b></p> <ul style="list-style-type: none"> <li>• Connect 104-Pin Breakout Box (BOB) to TIM and TIM C4998, C4999 using the BCM/TIM BOB Adapter Cable &amp; Overlay.</li> <li>• With key ON, monitor TIM PID EMG__PO.</li> <li>• Connect a jumper wire between BOB pins A19 and A35.</li> <li>• <b>Does the EMG__PO PID indicate DISABLE?</b></li> </ul>	<p>Yes = GO to <b>1-15</b>.</p> <p>No = GO to <b>1-17</b>.</p>
<p><b>1-15 CHECK CIRCUIT 3997 (DG) (OUTSIDE OF TRACTION BATTERY SUPPORT TRAY) FOR OPEN</b></p> <ul style="list-style-type: none"> <li>• With key OFF, disconnect BOB from TIM and TIM C4998, C4999.</li> </ul>	<p>Yes = GO to <b>1-16</b>.</p>

(Continued)

**DIAGNOSIS AND TESTING (Continued)****ROUTINE 1: VEHICLE DOES NOT START/VEHICLE QUILTS WHILE DRIVING (LEAD ACID VEHICLES)**

TEST STEP	ACTION TO TAKE
<ul style="list-style-type: none"> <li>With key OFF, disconnect in-line C1939 on the traction battery support tray and connect BOB to in-line C1939M using Traction Battery Low Voltage Service Cord; do not connect Traction Battery Low Voltage Service Cord to traction battery support tray in-line C1939F.</li> <li>With key OFF, measure the resistance of the DG wire between pin 35 on TIM C4998 and BOB pin 24.</li> <li><b>Is the resistance less than 5 ohms?</b></li> </ul>	No = REPAIR the DG wire.
<p><b>1-16 CHECK CIRCUIT 3997 (DG) (INSIDE OF TRACTION BATTERY SUPPORT TRAY) FOR OPEN</b></p> <ul style="list-style-type: none"> <li>Disconnect BOB from in-line C1939M, remove the traction battery, and connect Traction Battery High-Voltage Lockout and Diagnostic Tool to the traction battery high-voltage two-pin C3994M.</li> </ul> <p><b>⚠ WARNING: The traction battery contains high-voltage components and wiring. High-voltage insulated safety gloves and face shield must be worn when carrying out the following steps. Failure to follow this warning may result in severe personal injury or death.</b></p> <ul style="list-style-type: none"> <li>Connect BOB to traction battery support tray in-line C1939F using Traction Battery Low Voltage Service Cord; do not connect Traction Battery Low Voltage Service Cord to in-line C1939M.</li> <li>With key OFF, disconnect contactor box C1982 and measure the resistance of the DG wire between pin 16 on contactor box C1982 and BOB pin 24.</li> <li><b>Is the resistance less than 5 ohms?</b></li> </ul>	Yes = REPLACE the contactor box. REFER to <a href="#">Section 414-03A</a> . No = REPAIR the DG wire.
<p><b>1-17 CHECK CIRCUIT 3997 (DG) (OUTSIDE TRACTION BATTERY SUPPORT TRAY) FOR SHORT TO GROUND</b></p> <ul style="list-style-type: none"> <li>With key OFF, disconnect BOB from TIM and TIM C4998, C4999.</li> <li>With key OFF, disconnect in-line C1939 on the traction battery support tray and connect BOB to in-line C1939M using Traction Battery Low Voltage Service Cord; do not connect Traction Battery Low Voltage Service Cord to traction battery support tray in-line C1939F.</li> <li>With key OFF, measure the resistance between BOB pin 24 and ground (BOB pin 65).</li> <li><b>Is the resistance greater than 10,000 ohms?</b></li> </ul>	Yes = GO to <b>1-18</b> . No = REPAIR the DG wire.
<p><b>1-18 CHECK CIRCUIT 3997 (DG) (INSIDE OF TRACTION BATTERY SUPPORT TRAY) FOR SHORT TO GROUND</b></p> <ul style="list-style-type: none"> <li>Disconnect BOB from in-line C1939M, remove the traction battery, and connect Traction Battery High-Voltage Lockout and Diagnostic Tool to the traction battery high-voltage two-pin C3994M.</li> </ul> <p><b>⚠ WARNING: The traction battery contains high-voltage components and wiring. High-voltage insulated safety gloves and face shield must be worn when carrying out the following steps. Failure to follow this warning may result in severe personal injury or death.</b></p> <ul style="list-style-type: none"> <li>Connect BOB to traction battery support tray in-line C1939F using Traction Battery Low Voltage Service Cord; do not connect Traction Battery Low Voltage Service Cord to in-line C1939M.</li> <li>With key OFF, disconnect contactor box C1982 and measure the resistance BOB pin 24 and ground (BOB pin 65).</li> <li><b>Is the resistance greater than 10,000 ohms?</b></li> </ul>	Yes = REPLACE the TIM. REFER to <a href="#">Section 303-14</a> . No = REPAIR the DG wire.
<p><b>1-19 CHECK STATUS OF TIM OPERATING STATE</b></p> <ul style="list-style-type: none"> <li>With key ON, monitor TIM PID TIM__OP.</li> <li><b>Does the TIM__OP PID indicate 20 (shutdown)?</b></li> </ul>	Yes = GO to <b>1-20</b> . No = System OK.

(Continued)

**DIAGNOSIS AND TESTING (Continued)****ROUTINE 1: VEHICLE DOES NOT START/VEHICLE QUILTS WHILE DRIVING (LEAD ACID VEHICLES)**

TEST STEP	ACTION TO TAKE
<p><b>1-20 CHECK KEY RUN/START SIGNAL TO CONTACTOR BOX AT TRACTION BATTERY SUPPORT TRAY</b></p> <ul style="list-style-type: none"> <li>With key OFF, disconnect in-line C1939 on the traction battery support tray.</li> <li>Connect BOB to in-line C1939M using Traction Battery Low Voltage Service Cord; do not connect Traction Battery Low Voltage Service Cord to traction battery support tray in-line C1939F.</li> <li>With key ON, measure the voltage between BOB pin 21 and ground (BOB pin 65).</li> <li><b>Is the voltage greater than 10 volts?</b></li> </ul>	<p>Yes = GO to <b>1-21</b>.</p> <p>No = REPAIR circuit 295 (LB/BK).</p>
<p><b>1-21 CHECK CIRCUIT 295 (LB/PK) (INSIDE OF TRACTION BATTERY SUPPORT TRAY) FOR OPEN</b></p> <ul style="list-style-type: none"> <li>Disconnect the BOB from in-line C1939M, remove the traction battery, and connect Traction Battery High-Voltage Lockout and Diagnostic Tool to the traction battery high-voltage two-pin C3994M.</li> </ul> <p><b>⚠ WARNING: The traction battery contains high-voltage components and wiring. High-voltage insulated safety gloves and face shield must be worn when carrying out the following steps. Failure to follow this warning may result in severe personal injury or death.</b></p> <ul style="list-style-type: none"> <li>Connect BOB to traction battery support tray in-line C1939F using Traction Battery Low Voltage Service Cord; do not connect Traction Battery Low Voltage Service Cord to in-line C1939M.</li> <li>With key OFF, disconnect contactor box C1982 and measure the resistance of the LB/PK wire between pin 13 on contactor box C1982 and BOB pin 21.</li> <li><b>Is the resistance less than 5 ohms?</b></li> </ul>	<p>Yes = REPLACE the contactor box. REFER to <a href="#">Section 414-03A</a>.</p> <p>No = REPAIR the LB/PK wire.</p>

**ROUTINE 2: VEHICLE DOES NOT START/VEHICLE QUILTS WHILE DRIVING (NIMH VEHICLES)**

TEST STEP	ACTION TO TAKE
<p><b>2-1 CHECK AUXILIARY BATTERY VOLTAGE</b></p> <ul style="list-style-type: none"> <li>With key OFF, measure the voltage of the 12-volt auxiliary battery.</li> <li><b>Is the voltage greater than 11.5 volts?</b></li> </ul>	<p>Yes = GO to <b>2-2</b>.</p> <p>No = CARRY OUT the Auxiliary Battery Capacity Test. REFER to <a href="#">Section 414-02</a>.</p>
<p><b>2-2 CHECK STATUS OF BATTERY CONTROL MODULE (BCM) OPERATING STATE</b></p> <ul style="list-style-type: none"> <li>With key ON, monitor BCM PID BCM__OP.</li> </ul> <p><b>Does the BCM__OP PID indicate 48 (shutdown-low battery module voltage), 49 (shutdown-low SOC), 51 (no start-battery under temperature), or 54 (shutdown-battery over temperature)?</b></p>	<p>Yes = If BCM__OP PID indicates 48, GO to <b>2-3</b>.</p> <p>If BCM__OP PID indicates 49, CHARGE the traction battery. REFER to <a href="#">Section 100-05</a>.</p> <p>If BCM__OP PID indicates 51, GO to <b>2-6</b>.</p> <p>If BCM__OP PID indicates 54, GO to <b>2-9</b>.</p> <p>No = GO to <b>2-10</b>.</p>
<p><b>2-3 CHARGE TRACTION BATTERY TO FULL STATE OF CHARGE (SOC)</b></p>	

(Continued)

**DIAGNOSIS AND TESTING (Continued)****ROUTINE 2: VEHICLE DOES NOT START/VEHICLE QUILTS WHILE DRIVING (NIMH VEHICLES)**

TEST STEP	ACTION TO TAKE
<ul style="list-style-type: none"> <li>• Disconnect and reconnect the 12-volt auxiliary battery negative cable.</li> <li>• Charge the traction battery to full SOC.</li> <li>• With key ON, monitor BCM PID BCM__OP.</li> <li>• <b>Does the BCM__OP PID still indicate 48 (shutdown-low battery module voltage)?</b></li> </ul>	Yes = GO to <b>2-4</b> . No = System OK.
<b>2-4 CHECK STATUS OF TRACTION BATTERY MODULES BY CARRYING OUT THE BATTERY MODULE DIAGNOSTIC TEST</b> <ul style="list-style-type: none"> <li>• With key ON, carry out the Battery Module Diagnostic Test. Refer to the procedure in Traction Battery System <a href="#">Section 414-03B</a>.</li> <li>• <b>Does the Battery Module Diagnostic Test indicate to replace any battery modules?</b></li> </ul>	Yes = REPLACE the battery module(s) in question. REFER to <a href="#">Section 414-03B</a> . No = CHARGE the traction battery to full SOC. Go to <b>2-5</b> .
<b>2-5 CHECK TRACTION BATTERY TEMPERATURE SENSORS FOR UNDERTEMPERATURE CONDITION</b> <ul style="list-style-type: none"> <li>• With key ON, monitor BCM PIDs TMPSEN1, TMPSEN2, and TMPSEN3.</li> <li>• <b>Do any of the TMPSEN PIDs indicate less than -30°C (-22°F)?</b></li> </ul>	Yes = PARK the vehicle indoors in a warmer environment. CONNECT the vehicle to a power control station (PCS) to allow self-heating. GO to <b>2-6</b> . No = DISCONNECT and RECONNECT the 12-volt auxiliary battery negative cable and RECHECK the BCM__OP PID. If the BCM__OP PID still indicates 51, REPLACE the BCM. REFER to <a href="#">Section 414-03B</a> .
<b>2-6 CHECK IF UNDERTEMPERATURE STATE IS CAUSED BY AN ACTUAL UNDERTEMPERATURE CONDITION</b> <p><b>NOTE:</b> Allow adequate time for vehicle to warm before checking for temperature increase.</p> <ul style="list-style-type: none"> <li>• While vehicle is connected to the PCS, monitor BCM PIDs TMPSEN1, TMPSEN2, and TMPSEN3.</li> <li>• <b>Do the TMPSEN PIDs that were less than -30°C (-22°F) increase?</b></li> </ul>	Yes = ALLOW temperature(s) to increase above -25°C (-13°F). System OK. No = GO to <b>2-7</b> .
<b>2-7 CHECK BATTERY TEMPERATURE SENSORS</b> <ul style="list-style-type: none"> <li>• Remove the traction battery and connect Traction Battery High-Voltage Lockout and Diagnostic Tool to the traction battery high-voltage two-pin C3994M.</li> </ul> <p><b>⚠ WARNING: The traction battery contains high-voltage components and wiring. High-voltage insulated safety gloves and face shield must be worn when carrying out the following steps. Failure to follow this warning may result in severe personal injury or death.</b></p> <ul style="list-style-type: none"> <li>• Connect Traction Battery Low Voltage Service Cord to traction battery support tray in-line C1939F and in-line C1939M.</li> <li>• With key OFF, disconnect the battery temperature sensor in question and one of the other temperature sensors.</li> </ul>	Yes = REPLACE the BCM. REFER to <a href="#">Section 414-03B</a> . No = REPLACE the battery temperature sensor in question.

(Continued)

**DIAGNOSIS AND TESTING (Continued)****ROUTINE 2: VEHICLE DOES NOT START/VEHICLE QUILTS WHILE DRIVING (NIMH VEHICLES)**

TEST STEP	ACTION TO TAKE
<ul style="list-style-type: none"> <li>Connect jumper wires between the connector for the temperature sensor in question and the known good temperature sensor that was disconnected.</li> <li>With key ON, monitor BCM PIDs TMPSEN1, TMPSEN2, and TMPSEN3.</li> <li><b>Does the TMPSEN PID that indicated less than -30°C (-22°F) still indicate the same value?</b></li> </ul>	
<p><b>2-8 CHECK TRACTION BATTERY TEMPERATURE SENSORS FOR OVERTEMPERATURE CONDITION</b></p> <ul style="list-style-type: none"> <li>With key ON, monitor BCM PIDs TMPSEN1, TMPSEN2, and TMPSEN3.</li> <li><b>Do any of the TMPSEN PIDs indicate greater than 70°C (158°F)?</b></li> </ul>	<p>Yes = PARK the vehicle indoors in a cooler environment. CONNECT the vehicle to a power control station (PCS) to allow the traction battery fans to operate. GO to <b>2-9</b>.</p> <p>No = DISCONNECT and RECONNECT the 12-volt auxiliary battery negative cable and RECHECK the BCM_OP PID. If the BCM_OP PID still indicates 54, REPLACE the BCM. REFER to <a href="#">Section 414-03B</a>.</p>
<p><b>2-9 CHECK IF OVERTEMPERATURE STATE IS CAUSED BY AN ACTUAL OVERTEMPERATURE CONDITION</b></p> <p><b>NOTE:</b> Allow adequate time for vehicle to cool before checking for temperature decrease.</p> <ul style="list-style-type: none"> <li>While vehicle is connected to the PCS, monitor BCM PIDs TMPSEN1, TMPSEN2, and TMPSEN3.</li> <li><b>Do the TMPSEN PIDs that were greater than 70°C (158°F) decrease?</b></li> </ul>	<p>Yes = ALLOW temperature(s) to decrease below 55°C (131°F). System OK.</p> <p>No = GO to <b>2-10</b>.</p>
<p><b>2-10 CHECK BATTERY TEMPERATURE SENSORS</b></p> <ul style="list-style-type: none"> <li>Remove the traction battery and connect Traction Battery High-Voltage Lockout and Diagnostic Tool to the traction battery high-voltage two-pin C3994M.</li> </ul> <p> <b>WARNING: The traction battery contains high-voltage components and wiring. High-voltage insulated safety gloves and face shield must be worn when carrying out the following steps. Failure to follow this warning may result in severe personal injury or death.</b></p> <ul style="list-style-type: none"> <li>Connect Traction Battery High Voltage Service Cord to traction battery support tray in-line C1935F and in-line C1935M.</li> <li>Connect Traction Battery Low Voltage Service Cord to traction battery support tray in-line C1939F and in-line C1939M.</li> <li>With key OFF, disconnect the battery temperature sensor in question and one of the other temperature sensors.</li> </ul>	<p>Yes = REPLACE the BCM. REFER to <a href="#">Section 414-03B</a>.</p> <p>No = REPLACE the battery temperature sensor in question.</p>
<ul style="list-style-type: none"> <li>Connect jumper wires between the connector for the temperature sensor in question and the known good temperature sensor that was disconnected.</li> <li>With key ON, monitor BCM PIDs TMPSEN1, TMPSEN2, and TMPSEN3.</li> <li><b>Does the TMPSEN PID that indicated greater than 70°C (158°F) still indicate the same value?</b></li> </ul>	

(Continued)



**DIAGNOSIS AND TESTING (Continued)****ROUTINE 2: VEHICLE DOES NOT START/VEHICLE QUILTS WHILE DRIVING (NIMH VEHICLES)**

TEST STEP	ACTION TO TAKE
<b>2-11 CHECK STATUS OF KEY START SIGNAL TO TRACTION INVERTER MODULE (TIM)</b> <ul style="list-style-type: none"> <li>• With key ON, monitor TIM PID IGN__S.</li> <li>• Turn the ignition key to the START position.</li> <li>• <b>Does the IGN__S PID indicate YES when the ignition key is turned to the START position?</b></li> </ul>	Yes = GO to <b>2-14</b> . No = GO to <b>2-12</b> .
<b>2-12 CHECK FUSE (HOT IN START) TO TIM</b> <ul style="list-style-type: none"> <li>• Check 7.5A fuse 24, 10A fuse 9 and 7.5A fuse 11 in the I/P fuse panel.</li> <li>• <b>Is the fuse OK?</b></li> </ul>	Yes = GO to <b>2-13</b> . No = REPLACE the fuse. If the fuse fails again, CHECK/REPAIR for a short to ground.
<b>2-13 CHECK KEY START SIGNAL TO TIM</b> <ul style="list-style-type: none"> <li>• Connect 104-Pin Breakout Box (BOB) to TIM C4998, C4999 using the BCM/TIM BOB Adapter Cable &amp; Overlay; leave the TIM disconnected.</li> <li>• Connect a multimeter between BOB pins B8 and A29.</li> <li>• Turn the ignition key to the START position.</li> <li>• <b>Is the voltage greater than 10 volts when the ignition key is turned to the key START position?</b></li> </ul>	Yes = REPLACE the TIM. REFER to <a href="#">Section 303-14</a> . No = REPAIR the W/BK wire between pin 8 on TIM C4999 and the I/P fuse panel.
<b>2-14 CHECK EMERGENCY POWER OFF (EPO) STATUS TO TIM</b> <ul style="list-style-type: none"> <li>• With key ON, monitor TIM PID EMG__PO.</li> <li>• <b>Does the EMG__PO PID indicate ENABLE?</b></li> </ul>	Yes = GO to <b>2-15</b> . No = GO to <b>2-20</b> .
<b>2-15 CHECK EPO SIGNAL TO TIM</b> <ul style="list-style-type: none"> <li>• Connect 104-Pin Breakout Box (BOB) to TIM and TIM C4998, C4999 using the BCM/TIM BOB Adapter Cable &amp; Overlay.</li> <li>• With key ON, monitor TIM PID EMG__PO.</li> <li>• Connect a jumper wire between BOB pins A19 and A35.</li> <li>• <b>Does the EMG__PO PID indicate DISABLE?</b></li> </ul>	Yes = GO to <b>2-16</b> . No = GO to <b>2-18</b> .
<b>2-16 CHECK CIRCUIT 3997 (DG) (OUTSIDE OF TRACTION BATTERY SUPPORT TRAY) FOR OPEN</b> <ul style="list-style-type: none"> <li>• With key OFF, disconnect BOB from TIM and TIM C4998, C4999.</li> <li>• With key OFF, disconnect in-line C1939 on the traction battery support tray and connect BOB to in-line C1939M using Traction Battery Low Voltage Service Cord; do not connect Traction Battery Low Voltage Service Cord to traction battery support tray in-line C1939F.</li> <li>• With key OFF, measure the resistance of the DG wire between pin 35 on TIM C4998 and BOB pin 24.</li> <li>• <b>Is the resistance less than 5 ohms?</b></li> </ul>	Yes = GO to <b>2-17</b> . No = REPAIR the DG wire.
<b>2-17 CHECK CIRCUIT 3997 (DG) (INSIDE OF TRACTION BATTERY SUPPORT TRAY) FOR OPEN</b> <ul style="list-style-type: none"> <li>• Disconnect BOB from in-line C1939M, remove the traction battery, and connect Traction Battery High-Voltage Lockout and Diagnostic Tool to the traction battery high-voltage two-pin C3994M.</li> </ul>	Yes = REPLACE the contactor box. REFER to <a href="#">Section 414-03B</a> .

(Continued)



**DIAGNOSIS AND TESTING (Continued)****ROUTINE 2: VEHICLE DOES NOT START/VEHICLE QUILTS WHILE DRIVING (NIMH VEHICLES)**

TEST STEP	ACTION TO TAKE
<p> <b>WARNING: The traction battery contains high-voltage components and wiring. High-voltage insulated safety gloves and face shield must be worn when carrying out the following steps. Failure to follow this warning may result in severe personal injury or death.</b></p> <ul style="list-style-type: none"> <li>• Connect BOB to traction battery support tray in-line C1939F using Traction Battery Low Voltage Service Cord; do not connect Traction Battery Low Voltage Service Cord to in-line C1939M.</li> <li>• With key OFF, disconnect contactor box C1982 and measure the resistance of the DG wire between pin 16 on contactor box C1982 and BOB pin 24.</li> <li>• <b>Is the resistance less than 5 ohms?</b></li> </ul>	No = REPAIR the DG wire.
<p><b>2-18 CHECK CIRCUIT 3997 (DG) (OUTSIDE TRACTION BATTERY SUPPORT TRAY) FOR SHORT TO GROUND</b></p> <ul style="list-style-type: none"> <li>• With key OFF, disconnect BOB from TIM and TIM C4998, C4999.</li> <li>• With key OFF, disconnect in-line C1939 on the traction battery support tray and connect BOB to in-line C1939M using Traction Battery Low Voltage Service Cord; do not connect Traction Battery Low Voltage Service Cord to traction battery support tray in-line C1939F.</li> <li>• With key OFF, measure the resistance between BOB pin 24 and ground (BOB pin 65).</li> <li>• <b>Is the resistance greater than 10,000 ohms?</b></li> </ul>	Yes = GO to <b>2-19</b> . No = REPAIR the DG wire.
<p><b>2-19 CHECK CIRCUIT 3997 (DG) (INSIDE OF TRACTION BATTERY SUPPORT TRAY) FOR SHORT TO GROUND</b></p> <ul style="list-style-type: none"> <li>• Disconnect BOB from in-line C1939M, remove the traction battery, and connect Traction Battery High-Voltage Lockout and Diagnostic Tool to the traction battery high-voltage two-pin C3994M.</li> </ul> <p> <b>WARNING: The traction battery contains high-voltage components and wiring. High-voltage insulated safety gloves and face shield must be worn when carrying out the following steps. Failure to follow this warning may result in severe personal injury or death.</b></p> <ul style="list-style-type: none"> <li>• Connect BOB to traction battery support tray in-line C1939F using Traction Battery Low Voltage Service Cord; do not connect Traction Battery Low Voltage Service Cord to in-line C1939M.</li> <li>• With key OFF, disconnect contactor box C1982 and measure the resistance BOB pin 24 and ground (BOB pin 65).</li> <li>• <b>Is the resistance greater than 10,000 ohms?</b></li> </ul>	Yes = REPLACE the contactor box. REFER to <a href="#">Section 414-03B</a> . No = REPAIR the DG wire.
<p><b>2-20 CHECK STATUS OF TIM OPERATING STATE</b></p> <ul style="list-style-type: none"> <li>• With key ON, monitor TIM PID TIM__OP.</li> <li>• <b>Does the TIM__OP PID indicate 20 (shutdown)?</b></li> </ul>	Yes = GO to <b>2-21</b> . No = System OK.
<p><b>2-21 CHECK KEY RUN/START SIGNAL TO CONTACTOR BOX AT TRACTION BATTERY SUPPORT TRAY</b></p> <ul style="list-style-type: none"> <li>• With key OFF, disconnect in-line C1939 on the traction battery support tray.</li> <li>• Connect BOB to in-line C1939M using Traction Battery Low Voltage Service Cord; do not connect Traction Battery Low Voltage Service Cord to traction battery support tray in-line C1939F.</li> <li>• With key ON, measure the voltage between BOB pin 21 and ground (BOB pin 65).</li> <li>• <b>Is the voltage greater than 10 volts?</b></li> </ul>	Yes = GO to <b>2-22</b> . No = REPAIR circuit 295 (LB/BK).
<p><b>2-22 CHECK CIRCUIT 295 (LB/PK) (INSIDE OF TRACTION BATTERY SUPPORT TRAY) FOR OPEN</b></p>	

(Continued)

**DIAGNOSIS AND TESTING (Continued)****ROUTINE 2: VEHICLE DOES NOT START/VEHICLE QUILTS WHILE DRIVING (NIMH VEHICLES)**

TEST STEP	ACTION TO TAKE
<ul style="list-style-type: none"> <li>Disconnect the BOB from in-line C1939M, remove the traction battery, and connect Traction Battery High-Voltage Lockout and Diagnostic Tool to the traction battery high-voltage two-pin C3994M.</li> </ul> <p><b>⚠ WARNING: The traction battery contains high-voltage components and wiring. High-voltage insulated safety gloves and face shield must be worn when carrying out the following steps. Failure to follow this warning may result in severe personal injury or death.</b></p> <ul style="list-style-type: none"> <li>Connect BOB to traction battery support tray in-line C1939F using Traction Battery Low Voltage Service Cord; do not connect Traction Battery Low Voltage Service Cord to in-line C1939M.</li> <li>With key OFF, disconnect contactor box C1982 and measure the resistance of the LB/PK wire between pin 13 on contactor box C1982 and BOB pin 21.</li> <li>Is the resistance less than 5 ohms?</li> </ul>	<p>Yes = REPLACE the contactor box. REFER to <a href="#">Section 414-03B</a>.</p> <p>No = REPAIR the LB/PK wire.</p>

**ROUTINE 3: VEHICLE STARTS, BUT DOES NOT MOVE**

TEST STEP	ACTION TO TAKE
<p><b>3-1 CHECK STATUS OF BATTERY CONTROL MODULE (BCM) OPERATING STATE</b></p> <ul style="list-style-type: none"> <li>With key ON, monitor BCM PID BCM__OP.</li> <li>Does the BCM__OP PID indicate 69 (limited operating strategy drive-low state of charge )?</li> </ul>	<p>Yes = CHARGE the traction battery. REFER to <a href="#">Section 100-05</a>.</p> <p>No = GO to 3-2.</p>
<p><b>3-2 CHECK FOR PARK MECHANISM FAILURE</b></p> <ul style="list-style-type: none"> <li>Disconnect the shift linkage.</li> <li>Set the transmission range selector lever to the any position except P (Park).</li> <li>Raise the vehicle on a hoist.</li> <li>Rotate both rear wheels simultaneously in the same direction.</li> <li>Do the wheels rotate freely?</li> </ul>	<p>Yes = GO to 3-3.</p> <p>No = REPLACE the motor/transaxle. REFER to Section 303-01.</p>
<p><b>3-3 CHECK VEHICLE SPEED SENSORS</b></p> <p><b>NOTE:</b> The traction inverter module (TIM) diagnostic trouble code (DTC) C1856 Traction Motor Encoder Circuit Failure will not be set if either vehicle speed sensor (VSS) fails below 3 km/h (2 mph).</p> <ul style="list-style-type: none"> <li>Carry out Pinpoint Test B: DTC C1856 Traction Motor Encoder Circuit Failure. Refer to <a href="#">Section 303-14</a>.</li> <li>Are any faults indicated?</li> </ul>	<p>Yes = REPAIR as indicated in Pinpoint Test B.</p> <p>No = REPLACE the motor/transaxle. REFER to 303-01.</p>

**ROUTINE 4: VEHICLE OPERATES AT REDUCED POWER (LEAD ACID VEHICLES)**

TEST STEP	ACTION TO TAKE
<p><b>4-1 CHECK STATUS OF BATTERY CONTROL MODULE (BCM) OPERATING STATE</b></p> <ul style="list-style-type: none"> <li>With key ON, monitor BCM PID BCM__OP.</li> </ul>	<p>Yes = If BCM__OP PID indicates 67, GO to 4-2.</p> <p>If BCM__OP PID indicates 68, GO to 4-5.</p>

(Continued)

**DIAGNOSIS AND TESTING (Continued)****ROUTINE 4: VEHICLE OPERATES AT REDUCED POWER (LEAD ACID VEHICLES)**

TEST STEP	ACTION TO TAKE
<ul style="list-style-type: none"> <li>• Does the BCM_OP PID indicate 67 (limited operating strategy drive-battery overtemperature), 68 (LOS drive-battery undertemperature), or 69 (LOS drive-low state of charge )?</li> </ul>	<p>If BCM_OP PID indicates 69, CHARGE the traction battery. REFER to <a href="#">Section 100-05</a>.</p> <p>No = GO to 4-9.</p>
<p><b>4-2 CHECK TRACTION BATTERY TEMPERATURE SENSORS FOR OVERTEMPERATURE CONDITION</b></p> <ul style="list-style-type: none"> <li>• With key ON, monitor BCM PIDs TMPSEN1, TMPSEN2, TMPSEN3, and TMPSEN4.</li> <li>• Do any of the TMPSEN PIDs indicate greater than 65°C (149°F)?</li> </ul>	<p>Yes = GO to 4-3.</p> <p>No = If all TMPSEN PIDs are greater than 65°C (149°F), PARK the vehicle in a cool environment to cool down below 65°C (149°F). DISCONNECT and RECONNECT the 12-volt auxiliary battery negative cable and RECHECK the BCM_OP PID. If the BCM_OP PID still indicates 67, REPLACE the BCM. REFER to <a href="#">Section 414-03A</a>.</p>
<p><b>4-3 CHECK TEMPERATURE DIFFERENCE BETWEEN BATTERY TEMPERATURE SENSORS</b></p> <ul style="list-style-type: none"> <li>• With key ON, monitor BCM PIDs TMPSEN1, TMPSEN2, TMPSEN3, and TMPSEN4.</li> <li>• Is there a temperature difference of greater than 25°C (45°F) between the temperature sensor that is above 65°C (149°F) and the other temperature sensors?</li> </ul>	<p>Yes = GO to 4-4.</p> <p>No = PARK the vehicle in a cool environment to cool the vehicle below 65°C (149°F) for the temperature sensor in question.</p>
<p><b>4-4 CHECK BATTERY TEMPERATURE SENSOR</b></p> <ul style="list-style-type: none"> <li>• Remove the traction battery and connect Traction Battery High-Voltage Lockout and Diagnostic Tool to the traction battery high-voltage two-pin C3994M.</li> <li>• Connect Traction Battery High Voltage Service Cord to traction battery support tray in-line C1935F and in-line C1935M.</li> </ul>	<p>Yes = REPLACE the BCM. REFER to <a href="#">Section 414-03A</a>.</p> <p>No = REPLACE the battery temperature sensor in question.</p>

(Continued)

**DIAGNOSIS AND TESTING (Continued)****ROUTINE 4: VEHICLE OPERATES AT REDUCED POWER (LEAD ACID VEHICLES)**

TEST STEP	ACTION TO TAKE
<p> <b>WARNING: The traction battery contains high-voltage components and wiring. High-voltage insulated safety gloves and face shield must be worn when carrying out the following steps. Failure to follow this warning may result in severe personal injury or death.</b></p> <ul style="list-style-type: none"> <li>• Connect Traction Battery Low Voltage Service Cord to traction battery support tray in-line C1939F and in-line C1939M.</li> <li>• With key OFF, disconnect the battery temperature sensor in question and one of the other temperature sensors.</li> <li>• Connect jumper wires between the connector for the temperature sensor in question and the known good temperature sensor that was disconnected.</li> <li>• With key ON, monitor BCM PIDs TMPSEN1, TMPSEN2, TMPSEN3, and TMPSEN4.</li> <li>• <b>Does the TMPSEN PID that indicated greater than 65°C (149°F) still indicate 65°C (149°F)?</b></li> </ul>	
<p><b>4-5 CHECK TRACTION BATTERY TEMPERATURE SENSORS FOR UNDERTEMPERATURE CONDITION</b></p> <ul style="list-style-type: none"> <li>• With key ON, monitor BCM PIDs TMPSEN1, TMPSEN2, TMPSEN3, and TMPSEN4.</li> </ul> <p>• <b>Do any of the TMPSEN PIDs indicate less than -20°C (-4°F)?</b></p>	<p>Yes = GO to <b>4-6</b>.</p> <p>If all TMPSEN PIDs are less than -20°C (-4°F), PARK the vehicle indoors and if the vehicle is equipped with traction battery heaters, CONNECT it to the power control station (PCS) to warm the traction battery to a temperature greater than -15°C (5°F).</p> <p>No = DISCONNECT and RECONNECT the 12-volt auxiliary battery negative cable and RECHECK the BCM__OP PID. If the BCM__OP PID still indicates 68, REPLACE the BCM. REFER to <a href="#">Section 414-03A</a>.</p>
<p><b>4-6 IDENTIFY VEHICLE OPTION</b></p> <ul style="list-style-type: none"> <li>• Determine if the vehicle is equipped with traction battery heaters.</li> <li>• <b>Is the vehicle equipped with traction battery heaters?</b></li> </ul>	<p>Yes = GO to <b>4-7</b>.</p> <p>No = GO to <b>4-8</b>.</p>
<p><b>4-7 CHECK TEMPERATURE DIFFERENCE BETWEEN BATTERY TEMPERATURE SENSORS</b></p> <ul style="list-style-type: none"> <li>• With key ON, monitor BCM PIDs TMPSEN1, TMPSEN2, TMPSEN3, and TMPSEN4.</li> </ul>	<p>Yes = GO to <b>4-8</b>.</p>

(Continued)

**DIAGNOSIS AND TESTING (Continued)****ROUTINE 4: VEHICLE OPERATES AT REDUCED POWER (LEAD ACID VEHICLES)**

TEST STEP	ACTION TO TAKE
<ul style="list-style-type: none"> <li>• Is there a temperature difference of greater than 7°C (13°F) between the temperature sensor that is below -20°C (-4°F) and the other temperature sensors?</li> </ul>	No = CONNECT the vehicle to the PCS to warm the traction battery to a temperature greater than -15°C (5°F). MONITOR the TMPSEN PIDs while connected to the PCS. If the temperature of the battery temperature sensor that was less than -20°C (-4°F) does not increase, GO to <b>4-8</b> .
<b>4-8 CHECK BATTERY TEMPERATURE SENSOR</b> <ul style="list-style-type: none"> <li>• Remove the traction battery and connect Traction Battery High-Voltage Lockout and Diagnostic Tool to the traction battery high-voltage two-pin C3994M.</li> <li>• Connect Traction Battery High Voltage Service Cord to traction battery support tray in-line C1935F and in-line C1935M.</li> </ul> <p> <b>WARNING: The traction battery contains high-voltage components and wiring. High-voltage insulated safety gloves and face shield must be worn when carrying out the following steps. Failure to follow this warning may result in severe personal injury or death.</b></p> <ul style="list-style-type: none"> <li>• Connect Traction Battery Low Voltage Service Cord to traction battery support tray in-line C1939F and in-line C1939M.</li> <li>• With key OFF, disconnect the battery temperature sensor in question and one of the other temperature sensors.</li> <li>• Connect jumper wires between the connector for the temperature sensor in question and the known good temperature sensor that was disconnected.</li> <li>• With key ON, monitor BCM PIDs TMPSEN1, TMPSEN2, TMPSEN3, and TMPSEN4.</li> <li>• Does the TMPSEN PID that indicated less than -20°C (-4°F) still indicate -20°C (-4°F)?</li> </ul>	Yes = REPLACE the BCM. REFER to <a href="#">Section 414-03A</a> . No = REPLACE the battery temperature sensor in question.
<b>4-9 CHECK STATUS OF TRACTION BATTERY MODULES BY CARRYING OUT THE BATTERY MODULE DIAGNOSTIC TEST</b> <ul style="list-style-type: none"> <li>• With key ON, carry out the Battery Module Diagnostic Test. Refer to the procedure in Traction Battery System <a href="#">Section 414-03A</a>.</li> <li>• Does the Battery Module Diagnostic Test indicate to replace any battery modules?</li> </ul>	Yes = REPLACE the battery module(s) in question. REFER to <a href="#">Section 414-03A</a> . No = GO to <b>4-10</b> .
<b>4-10 CHECK MOTOR TEMPERATURE</b> <ul style="list-style-type: none"> <li>• Drive the vehicle until the vehicle runs at reduced power.</li> <li>• With key ON, monitor the traction inverter motor (TIM) PID TIMTEMP and note the temperature.</li> <li>• Is the temperature greater than 170°C (338°F)?</li> </ul>	Yes = GO to <b>4-11</b> . No = GO to <b>4-12</b> .
<b>4-11 CHECK MOTOR TEMPERATURE SENSOR</b> <ul style="list-style-type: none"> <li>• With key OFF, disconnect motor/transaxle C4993 and connect Electric Motor/Transaxle Test Box.</li> <li>• Measure the resistance between the motor temperature ports on the test box and determine the motor temperature from the following resistance values:</li> </ul>	Yes = REPLACE the motor/transaxle. REFER to Section 303-01. No = GO to <b>4-13</b> .

(Continued)

**DIAGNOSIS AND TESTING (Continued)****ROUTINE 4: VEHICLE OPERATES AT REDUCED POWER (LEAD ACID VEHICLES)**

TEST STEP	ACTION TO TAKE
<p><b>Resistance</b></p> <ul style="list-style-type: none"> <li>—493 ohms = 0 °C (32°F)</li> <li>—533 ohms = 10 °C (50°F)</li> <li>—576 ohms = 20 °C (68°F)</li> <li>—598 ohms = 25 °C (77°F)</li> <li>—621 ohms = 30 °C (86°F)</li> <li>—668 ohms = 40 °C (104°F)</li> <li>—718 ohms = 50 °C (122°F)</li> <li>—769 ohms = 60 °C (140°F)</li> <li>—824 ohms = 70 °C (158°F)</li> <li>—880 ohms = 80 °C (176°F)</li> <li>—939 ohms = 90 °C (194°F)</li> <li>—1,000 ohms = 100 °C (212°F)</li> <li>—1,063 ohms = 110 °C (230°F)</li> <li>—1,129 ohms = 120 °C (248°F)</li> <li>—1,197 ohms = 130 °C (266°F)</li> <li>—1,268 ohms = 140 °C (284°F)</li> <li>—1,340 ohms = 150 °C (302°F)</li> <li>—1,415 ohms = 160 °C (320°F)</li> <li>—1,493 ohms = 170 °C (338°F)</li> <li>—1,572 ohms = 180 °C (356°F)</li> <li>—1,654 ohms = 190 °C (374°F)</li> <li>—1,738 ohms = 200 °C (392°F)</li> <li>—1,825 ohms = 210 °C (410°F)</li> <li>—1,914 ohms = 220 °C (428°F)</li> <li>—2,006 ohms = 230 °C (446°F)</li> <li>—2,088 ohms = 240 °C (464°F)</li> <li>—2,196 ohms = 250 °C (482°F)</li> <li>—2,293 ohms = 260 °C (500°F)</li> <li>—2,392 ohms = 270 °C (518°F)</li> <li>—2,490 ohms = 280 °C (536°F)</li> <li>—2,584 ohms = 290 °C (554°F)</li> <li>—2,688 ohms = 300 °C (572°F)</li> </ul> <p>• <b>Is the TRNTEMP PID approximately equal to the motor temperature?</b></p>	
<p><b>4-12 CHECK TIM</b></p> <ul style="list-style-type: none"> <li>• Measure the resistance between the motor temperature ports on the Electric Motor/Transaxle Test Box, determine the motor temperature, and compare the temperature to the TRNTEMP PID from test step 4-11.</li> <li>• <b>Is the TIMTEMP PID approximately equal to the motor temperature?</b></li> </ul>	<p>Yes = REPLACE the TIM. REFER to <a href="#">Section 303-14</a>.</p> <p>No = GO to <b>4-13</b>.</p>
<p><b>4-13 VERIFY THE MEASURED RESISTANCE/TEMPERATURE IS IN RANGE</b></p> <ul style="list-style-type: none"> <li>• Note the measured resistance in test step 4-13.</li> <li>• <b>Is the resistance within the range indicated in the list in test step 4-12?</b></li> </ul>	<p>Yes = REPLACE the TIM. REFER to <a href="#">Section 303-14</a>.</p> <p>No = REPLACE the motor/transaxle. REFER to Section 303-01.</p>

**DIAGNOSIS AND TESTING (Continued)****ROUTINE 5: VEHICLE OPERATES AT REDUCED POWER (NIMH VEHICLES)**

TEST STEP	ACTION TO TAKE
<p><b>5-1 CHECK STATUS OF BATTERY CONTROL MODULE (BCM) OPERATING STATE</b></p> <ul style="list-style-type: none"> <li>With key ON, monitor BCM PID BCM__OP.</li> </ul> <p><b>• Does the BCM__OP PID indicate 67 (limited operating strategy drive-battery overtemperature), 68 (LOS drive-battery undertemperature), or 69 (LOS drive-low state of charge )?</b></p>	<p>Yes = If BCM__OP PID indicates 67, GO to <b>5-2</b>. If BCM__OP PID indicates 68, GO to <b>5-5</b>. If BCM__OP PID indicates 69, CHARGE the traction battery. REFER to <a href="#">Section 100-05</a>.</p> <p>No = GO to <b>5-8</b>.</p>
<p><b>5-2 CHECK TRACTION BATTERY TEMPERATURE SENSORS FOR OVERTEMPERATURE CONDITION</b></p> <ul style="list-style-type: none"> <li>With key ON, monitor BCM PIDs TMPSEN1, TMPSEN2, and TMPSEN3.</li> </ul> <p><b>• Do any of the TMPSEN PIDs indicate greater than 55°C (131°F)?</b></p>	<p>Yes = PARK the vehicle indoors in a cooler environment. CONNECT the vehicle to a power control station (PCS) to allow the traction battery fans to operate. GO to <b>5-3</b>.</p> <p>No = DISCONNECT and RECONNECT the 12-volt auxiliary battery negative cable and RECHECK the BCM__OP PID. If the BCM__OP PID still indicates 67, REPLACE the BCM. REFER to <a href="#">Section 414-03B</a>.</p>
<p><b>5-3 CHECK IF OVERTEMPERATURE STATE IS CAUSED BY AN ACTUAL OVERTEMPERATURE CONDITION</b></p> <p><b>NOTE:</b> Allow adequate time for vehicle to cool before checking for temperature decrease.</p> <ul style="list-style-type: none"> <li>While vehicle is connected to the PCS, monitor BCM PIDs TMPSEN1, TMPSEN2, and TMPSEN3.</li> </ul> <p><b>• Do the TMPSEN PIDs that were greater than 55°C (131°F) decrease?</b></p>	<p>Yes = ALLOW temperature(s) to decrease below 55°C (131°F). System OK.</p> <p>No = GO to <b>5-4</b>.</p>
<p><b>5-4 CHECK BATTERY TEMPERATURE SENSORS</b></p> <ul style="list-style-type: none"> <li>Remove the traction battery and connect Traction Battery High-Voltage Lockout and Diagnostic Tool to the traction battery high-voltage two-pin C3994M.</li> </ul>	<p>Yes = REPLACE the BCM. REFER to <a href="#">Section 414-03B</a>.</p>

(Continued)

**DIAGNOSIS AND TESTING (Continued)****ROUTINE 5: VEHICLE OPERATES AT REDUCED POWER (NIMH VEHICLES)**

TEST STEP	ACTION TO TAKE
<p><b>⚠ WARNING: The traction battery contains high-voltage components and wiring. High-voltage insulated safety gloves and face shield must be worn when carrying out the following steps. Failure to follow this warning may result in severe personal injury or death.</b></p> <ul style="list-style-type: none"> <li>• Connect Traction Battery High Voltage Service Cord to traction battery support tray in-line C1935F and in-line C1935M.</li> <li>• Connect Traction Battery Low Voltage Service Cord to traction battery support tray in-line C1939F and in-line C1939M.</li> <li>• With key OFF, disconnect the battery temperature sensor in question and one of the other temperature sensors.</li> <li>• Connect jumper wires between the connector for the temperature sensor in question and the known good temperature sensor that was disconnected.</li> <li>• With key ON, monitor BCM PIDs TMPSEN1, TMPSEN2, and TMPSEN3.</li> <li>• <b>Does the TMPSEN PID that indicated greater than 55°C (131°F) still indicate the same value?</b></li> </ul>	<p>No = REPLACE the battery temperature sensor in question.</p>
<p><b>5-5 CHECK TRACTION BATTERY TEMPERATURE SENSORS FOR UNDERTEMPERATURE CONDITION</b></p> <ul style="list-style-type: none"> <li>• With key ON, monitor BCM PIDs TMPSEN1, TMPSEN2, and TMPSEN3.</li> <li>• <b>Do any of the TMPSEN PIDs indicate less than -25°C (-13°F)?</b></li> </ul>	<p>Yes = PARK the vehicle indoors in a warmer environment. CONNECT the vehicle to a power control station (PCS) to allow self-heating. GO to 5-6.</p> <p>No = DISCONNECT and RECONNECT the 12-volt auxiliary battery negative cable and RECHECK the BCM_OP PID. If the BCM_OP PID still indicates 68, REPLACE the BCM. REFER to <a href="#">Section 414-03B</a>.</p>
<p><b>5-6 CHECK IF UNDERTEMPERATURE STATE IS CAUSED BY AN ACTUAL UNDERTEMPERATURE CONDITION</b></p> <p><b>NOTE:</b> Allow adequate time for vehicle to warm before checking for temperature increase.</p> <ul style="list-style-type: none"> <li>• While vehicle is connected to the PCS, monitor BCM PIDs TMPSEN1, TMPSEN2, and TMPSEN3.</li> <li>• <b>Do the TMPSEN PIDs that were less than -25°C (-13°F) increase?</b></li> </ul>	<p>Yes = ALLOW temperature(s) to increase above -25°C (-13°F). System OK.</p> <p>No = GO to 5-7.</p>
<p><b>5-7 CHECK BATTERY TEMPERATURE SENSORS</b></p> <ul style="list-style-type: none"> <li>• Remove the traction battery and connect Traction Battery High-Voltage Lockout and Diagnostic Tool to the traction battery high-voltage two-pin C3994M.</li> </ul>	<p>Yes = REPLACE the BCM. REFER to <a href="#">Section 414-03B</a>.</p>

(Continued)



**DIAGNOSIS AND TESTING (Continued)****ROUTINE 5: VEHICLE OPERATES AT REDUCED POWER (NIMH VEHICLES)**

TEST STEP	ACTION TO TAKE
<p><b>⚠ WARNING: The traction battery contains high-voltage components and wiring. High-voltage insulated safety gloves and face shield must be worn when carrying out the following steps. Failure to follow this warning may result in severe personal injury or death.</b></p> <ul style="list-style-type: none"> <li>• Connect Traction Battery High Voltage Service Cord to traction battery support tray in-line C1935F and in-line C1935M.</li> <li>• Connect Traction Battery Low Voltage Service Cord to traction battery support tray in-line C1939F and in-line C1939M.</li> <li>• With key OFF, disconnect the battery temperature sensor in question and one of the other temperature sensors.</li> <li>• Connect jumper wires between the connector for the temperature sensor in question and the known good temperature sensor that was disconnected.</li> <li>• With key ON, monitor BCM PIDs TMPSEN1, TMPSEN2, and TMPSEN3.</li> <li>• <b>Does the TMPSEN PID that indicated less than -25°C (-13°F) still indicate the same value?</b></li> </ul>	<p>No = REPLACE the battery temperature sensor in question.</p>
<p><b>5-8 CHECK STATUS OF TRACTION BATTERY MODULES BY CARRYING OUT THE BATTERY MODULE DIAGNOSTIC TEST</b></p> <ul style="list-style-type: none"> <li>• With key ON, carry out the Battery Module Diagnostic Test. Refer to the procedure in Traction Battery System <a href="#">Section 414-03B</a>.</li> <li>• <b>Does the Battery Module Diagnostic Test indicate to replace any battery modules?</b></li> </ul>	<p>Yes = REPLACE the battery module(s) in question. REFER to <a href="#">Section 414-03B</a>.</p> <p>No = GO to <b>5-9</b>.</p>
<p><b>5-9 CHECK MOTOR TEMPERATURE</b></p> <ul style="list-style-type: none"> <li>• Drive the vehicle until the vehicle runs at reduced power.</li> <li>• With key ON, monitor the traction inverter motor (TIM) PID TRNTEMP and note the temperature.</li> <li>• <b>Is the temperature greater than 170°C (338°F)?</b></li> </ul>	<p>Yes = GO to <b>5-10</b>.</p> <p>No = GO to <b>5-11</b>.</p>
<p><b>5-10 CHECK MOTOR TEMPERATURE SENSOR</b></p> <ul style="list-style-type: none"> <li>• With key OFF, disconnect motor/transaxle C4993 and connect Electric Motor/Transaxle Test Box.</li> <li>• Measure the resistance between the motor temperature ports on the test box and determine the motor temperature from the following resistance values: <b>Resistance</b></li> </ul> <ul style="list-style-type: none"> <li>—493 ohms = 0 °C (32°F)</li> <li>—533 ohms = 10 °C (50°F)</li> <li>—576 ohms = 20 °C (68°F)</li> <li>—598 ohms = 25 °C (77°F)</li> <li>—621 ohms = 30 °C (86°F)</li> <li>—668 ohms = 40 °C (104°F)</li> <li>—718 ohms = 50 °C (122°F)</li> <li>—769 ohms = 60 °C (140°F)</li> <li>—824 ohms = 70 °C (158°F)</li> <li>—880 ohms = 80 °C (176°F)</li> <li>—939 ohms = 90 °C (194°F)</li> <li>—1,000 ohms = 100 °C (212°F)</li> <li>—1,063 ohms = 110 °C (230°F)</li> </ul>	<p>Yes = REPLACE the motor/transaxle. REFER to Section 303-01.</p> <p>No = GO to <b>5-12</b>.</p>

(Continued)

**DIAGNOSIS AND TESTING (Continued)****ROUTINE 5: VEHICLE OPERATES AT REDUCED POWER (NIMH VEHICLES)**

TEST STEP	ACTION TO TAKE
<ul style="list-style-type: none"> <li>—1,129 ohms = 120 °C (248°F)</li> <li>—1,197 ohms = 130 °C (266°F)</li> <li>—1,268 ohms = 140 °C (284°F)</li> <li>—1,340 ohms = 150 °C (302°F)</li> <li>—1,415 ohms = 160 °C (320°F)</li> <li>—1,493 ohms = 170 °C (338°F)</li> <li>—1,572 ohms = 180 °C (356°F)</li> <li>—1,654 ohms = 190 °C (374°F)</li> <li>—1,738 ohms = 200 °C (392°F)</li> <li>—1,825 ohms = 210 °C (410°F)</li> <li>—1,914 ohms = 220 °C (428°F)</li> <li>—2,006 ohms = 230 °C (446°F)</li> <li>—2,088 ohms = 240 °C (464°F)</li> <li>—2,196 ohms = 250 °C (482°F)</li> <li>—2,293 ohms = 260 °C (500°F)</li> <li>—2,392 ohms = 270 °C (518°F)</li> <li>—2,490 ohms = 280 °C (536°F)</li> <li>—2,584 ohms = 290 °C (554°F)</li> <li>—2,688 ohms = 300 °C (572°F)</li> </ul> <ul style="list-style-type: none"> <li>• <b>Is the TRNTEMP PID approximately equal to the motor temperature?</b></li> </ul>	
<p><b>5-11 CHECK TIM</b></p> <ul style="list-style-type: none"> <li>• Measure the resistance between the motor temperature ports on the Electric Motor/Transaxle Test Box, determine the motor temperature, and compare the temperature to the TRNTEMP PID from test step 5-10.</li> <li>• <b>Is the TIMTEMP PID approximately equal to the motor temperature?</b></li> </ul>	<p>Yes = REPLACE the TIM. REFER to <a href="#">Section 303-14</a>.</p> <p>No = GO to <b>5-12</b>.</p>
<p><b>5-12 VERIFY THE MEASURED RESISTANCE/TEMPERATURE IS IN RANGE</b></p> <ul style="list-style-type: none"> <li>• Note the measured resistance in test step 5-11.</li> <li>• <b>Is the resistance within the range indicated in the list in test step 5-10?</b></li> </ul>	<p>Yes = REPLACE the TIM. REFER to <a href="#">Section 303-14</a>.</p> <p>No = REPLACE the motor/transaxle. REFER to Section 303-01.</p>

**ROUTINE 6: NOTICEABLE DECREASE IN VEHICLE DRIVING RANGE (LEAD ACID VEHICLES)**

TEST STEP	ACTION TO TAKE
<p><b>6-1 CHECK STATUS OF TRACTION BATTERY MODULES BY CARRYING OUT THE BATTERY MODULE DIAGNOSTIC TEST</b></p> <ul style="list-style-type: none"> <li>• With key ON, carry out the Battery Module Diagnostic Test. Refer to the procedure in Traction Battery System <a href="#">Section 414-03A</a>.</li> <li>• <b>Does the Battery Module Diagnostic Test indicate to replace any battery modules?</b></li> </ul>	<p>Yes = REPLACE the battery module(s) in question. REFER to <a href="#">Section 414-03A</a>.</p> <p>No = GO to <b>6-2</b>.</p>
<p><b>6-2 IDENTIFY VEHICLE OPTION</b></p> <ul style="list-style-type: none"> <li>• Determine if the vehicle is equipped with traction battery heaters.</li> </ul>	<p>Yes = GO to <b>6-3</b>.</p>

(Continued)

**DIAGNOSIS AND TESTING (Continued)****ROUTINE 6: NOTICEABLE DECREASE IN VEHICLE DRIVING RANGE (LEAD ACID VEHICLES)**

TEST STEP	ACTION TO TAKE
<ul style="list-style-type: none"> <li>• Is the vehicle equipped with traction battery heaters?</li> </ul>	No = INFORM the customer that the decrease in vehicle driving range may be due to harsh driving or storage conditions, or not allowing the vehicle to charge to the full state of charge (SOC).
<b>6-3 CHECK STATUS OF HEATER PRESENT SIGNAL</b> <ul style="list-style-type: none"> <li>• With key ON, monitor BCM PID HTRPRST.</li> </ul> <ul style="list-style-type: none"> <li>• Does the HTRPRST PID indicate YES?</li> </ul>	Yes = INFORM the customer that the decrease in vehicle driving range may be due to harsh driving or storage conditions, or not allowing the vehicle to charge to the full state of charge (SOC).  No = GO to <b>6-4</b> .
<b>6-4 CHECK HEATER PRESENT SIGNAL FROM CONTACTOR BOX</b> <ul style="list-style-type: none"> <li>• Remove the traction battery and connect Traction Battery High-Voltage Lockout and Diagnostic Tool to the traction battery high-voltage two-pin C3994M.</li> </ul> <p> <b>WARNING: The traction battery contains high-voltage components and wiring. High-voltage insulated safety gloves and face shield must be worn when carrying out the following steps. Failure to follow this warning may result in severe personal injury or death.</b></p> <ul style="list-style-type: none"> <li>• Connect Traction Battery High Voltage Service Cord to traction battery support tray in-line C1935F and in-line C1935M.</li> <li>• Connect Traction Battery Low Voltage Service Cord to traction battery support tray in-line C1939F and in-line C1939M.</li> <li>• Connect 104-Pin Breakout Box (BOB) to BCM C1986, C1987 using the BCM/TIM BOB Adapter Cable and Overlay; leave the BCM disconnected.</li> <li>• With key OFF, measure the resistance between BOB pin A31 and ground (BOB pin A33).</li> <li>• Is the resistance less than 20 ohms?</li> </ul>	Yes = REPLACE the BCM. REFER to <a href="#">Section 414-03A</a> .  No = GO to <b>6-5</b> .
<b>6-5 CHECK CIRCUIT 3007 (P/Y) FOR OPEN</b> <ul style="list-style-type: none"> <li>• With key OFF, disconnect contactor box C1982 and measure the resistance of the P/Y wire between pin 14 on contactor box C1982 and BOB pin A31.</li> <li>• Is the resistance less than 5 ohms?</li> </ul>	Yes = GO to <b>6-6</b> .  No = REPAIR the P/Y wire.
<b>6-6 CHECK HEATER JUMPER CIRCUIT 1161 (DB/O) FOR OPEN</b> <ul style="list-style-type: none"> <li>• With key OFF, disconnect contactor box C1864 and measure the resistance of the DB/O wire between pins D and E on contactor box C1864.</li> <li>• Is the resistance less than 5 ohms?</li> </ul>	Yes = REPLACE the contactor box. REFER to <a href="#">Section 414-03A</a> .  No = REPLACE high-voltage harness (10B700).

**DIAGNOSIS AND TESTING (Continued)****ROUTINE 7: NOTICEABLE DECREASE IN VEHICLE DRIVING RANGE (NIMH VEHICLES)**

TEST STEP	ACTION TO TAKE
<p><b>7-1 CHECK STATUS OF TRACTION BATTERY MODULES BY CARRYING OUT THE BATTERY MODULE DIAGNOSTIC TEST</b></p> <ul style="list-style-type: none"> <li>With key ON, carry out the Battery Module Diagnostic Test. Refer to the procedure in Traction Battery System <a href="#">Section 414-03B</a>.</li> <li><b>Does the Battery Module Diagnostic Test indicate to replace any battery modules?</b></li> </ul>	<p>Yes = REPLACE the battery module(s) in question. REFER to <a href="#">Section 414-03B</a>.</p> <p>No = INFORM the customer that the decrease in vehicle driving range may be due to harsh driving or storage conditions, or not allowing the vehicle to charge to the full state of charge (SOC).</p>

**ROUTINE 8: VEHICLE DOES NOT CHARGE (LEAD ACID VEHICLES)**

TEST STEP	ACTION TO TAKE
<p><b>8-1 CHECK STATUS OF BATTERY CONTROL MODULE (BCM) OPERATING STATE</b></p> <ul style="list-style-type: none"> <li>Verify the ignition key is in the OFF position and the gear selector is in the P (Park) position.</li> <li>Connect the vehicle to a power control station (PCS) and press the START button to begin charging.</li> </ul> <p><b>NOTE:</b> Wait approximately five minutes to allow the BCM__OP PID to be set.</p> <ul style="list-style-type: none"> <li>With key OFF and vehicle on-charge, monitor BCM PID BCM__OP. Check for the following numbers: <ul style="list-style-type: none"> <li>—48 (shutdown-low battery module voltage)</li> <li>—83 (no charge-battery overtemperature)</li> <li>—84 (no charge-battery undertemperature)</li> <li>—87 (no charge-battery full)</li> <li>—96 (no charge-EPO detected)</li> <li>—99 (no charge-line capacity out of range)</li> <li>—101 (no charge-no AC to charger)</li> </ul> </li> <li><b>Does the BCM__OP PID indicate 48, 83, 84, 87, 96, 99, or 101?</b></li> </ul>	<p>Yes = If 48, GO to <b>8-2</b>. If 83, GO to <b>8-5</b>. If 84, GO to <b>8-8</b>. If 87, the traction battery is at full state of charge (SOC). System OK. If 96, GO to <b>8-12</b>. If 99, GO to <b>8-15</b>. If 101, GO to <b>8-24</b>.</p> <p>No = GO to <b>8-29</b>.</p>
<p><b>8-2 CHARGE TRACTION BATTERY TO FULL STATE OF CHARGE (SOC)</b></p> <ul style="list-style-type: none"> <li>Disconnect and reconnect the 12-volt auxiliary battery negative cable.</li> <li>Charge the traction battery to full SOC.</li> <li>With key ON, monitor BCM PID BCM__OP.</li> <li><b>Does the BCM__OP PID still indicate 48 (shutdown-low battery module voltage)?</b></li> </ul>	<p>Yes = GO to <b>8-3</b>.</p> <p>No = System OK.</p>
<p><b>8-3 CHECK STATUS OF TRACTION BATTERY MODULES BY CARRYING OUT THE BATTERY MODULE DIAGNOSTIC TEST</b></p> <ul style="list-style-type: none"> <li>With key ON, carry out the Battery Module Diagnostic Test. Refer to the procedure in Traction Battery System <a href="#">Section 414-03A</a>.</li> </ul>	<p>Yes = REPLACE the battery module(s) in question. REFER to <a href="#">Section 414-03A</a>.</p>

(Continued)

**DIAGNOSIS AND TESTING (Continued)****ROUTINE 8: VEHICLE DOES NOT CHARGE (LEAD ACID VEHICLES)**

TEST STEP	ACTION TO TAKE
<ul style="list-style-type: none"> <li>• Does the Battery Module Diagnostic Test indicate to replace any battery modules?</li> </ul>	No = CHARGE the traction battery to full SOC. CHECK the BCM__OP PID. If the BCM__OP PID still indicates 48, REPLACE the BCM. REFER to <a href="#">Section 414-03A</a> .
<b>8-4 CHECK TRACTION BATTERY TEMPERATURE SENSORS FOR OVERTEMPERATURE CONDITION</b> <ul style="list-style-type: none"> <li>• With key ON, monitor BCM PIDs TMPSEN1, TMPSEN2, TMPSEN3, and TMPSEN4.</li> </ul> <ul style="list-style-type: none"> <li>• Do any of the TMPSEN PIDs indicate greater than 60°C (140°F)?</li> </ul>	Yes = GO to <b>8-5</b> .  If all TMPSEN PIDs are greater than 60°C (140°F), PARK the vehicle in a cool environment to cool down below 60°C (140°F).  No = DISCONNECT and RECONNECT the 12-volt auxiliary battery negative cable and RECHECK the BCM__OP PID. If the BCM__OP PID still indicates 83, REPLACE the BCM. REFER to <a href="#">Section 414-03A</a> .
<b>8-5 CHECK TEMPERATURE DIFFERENCE BETWEEN BATTERY TEMPERATURE SENSORS</b> <ul style="list-style-type: none"> <li>• With key ON, monitor BCM PIDs TMPSEN1, TMPSEN2, TMPSEN3, and TMPSEN4.</li> <li>• Is there a temperature difference of greater than 25°C (45°F) between the temperature sensor that is above 60°C (140°F) and the other temperature sensors?</li> </ul>	Yes = GO to <b>8-6</b> .  No = PARK the vehicle in a cool environment to cool the vehicle below 60°C (140°F) for the temperature sensor in question.
<b>8-6 CHECK BATTERY TEMPERATURE SENSOR (OVERTEMPERATURE CONDITION)</b> <ul style="list-style-type: none"> <li>• Remove the traction battery and connect Traction Battery High-Voltage Lockout and Diagnostic Tool to the traction battery high-voltage two-pin C3994M.</li> <li>• Connect Traction Battery High Voltage Service Cord to traction battery support tray in-line C1935F and in-line C1935M.</li> </ul>	Yes = REPLACE the BCM. REFER to <a href="#">Section 414-03A</a> .  No = REPLACE the battery temperature sensor in question.

(Continued)

**DIAGNOSIS AND TESTING (Continued)****ROUTINE 8: VEHICLE DOES NOT CHARGE (LEAD ACID VEHICLES)**

TEST STEP	ACTION TO TAKE
<p> <b>WARNING: The traction battery contains high-voltage components and wiring. High-voltage insulated safety gloves and face shield must be worn when carrying out the following steps. Failure to follow this warning may result in severe personal injury or death.</b></p> <ul style="list-style-type: none"> <li>• Connect Traction Battery Low Voltage Service Cord to traction battery support tray in-line C1939F and in-line C1939M.</li> <li>• With key OFF, disconnect the battery temperature sensor in question and one of the other temperature sensors.</li> <li>• Connect jumper wires between the connector for the temperature sensor in question and the known good temperature sensor that was disconnected.</li> <li>• With key ON, monitor BCM PIDs TMPSEN1, TMPSEN2, TMPSEN3, and TMPSEN4.</li> <li>• <b>Does the TMPSEN PID that indicated greater than 60°C (140°F) still indicate 60°C (140°F)?</b></li> </ul>	
<p><b>8-7 CHECK TRACTION BATTERY TEMPERATURE SENSORS FOR UNDERTEMPERATURE CONDITION</b></p> <ul style="list-style-type: none"> <li>• With key ON, monitor BCM PIDs TMPSEN1, TMPSEN2, TMPSEN3, and TMPSEN4.</li> </ul> <p>• <b>Do any of the TMPSEN PIDs indicate less than 5°C (41°F)?</b></p>	<p>Yes = GO to <b>8-8</b>.</p> <p>If all TMPSEN PIDs are less than 5°C (41°F), PARK the vehicle indoors and if the vehicle is equipped with traction battery heaters, CONNECT it to the power control station (PCS) to warm the traction battery to a temperature greater than 7°C (45°F).</p> <p>No = DISCONNECT and RECONNECT the 12-volt auxiliary battery negative cable and RECHECK the BCM__OP PID. If the BCM__OP PID still indicates 84, REPLACE the BCM. REFER to <a href="#">Section 414-03A</a>.</p>
<p><b>8-8 IDENTIFY VEHICLE OPTION</b></p> <ul style="list-style-type: none"> <li>• Determine if the vehicle is equipped with traction battery heaters.</li> <li>• <b>Is the vehicle equipped with traction battery heaters?</b></li> </ul>	<p>Yes = GO to <b>8-9</b>.</p> <p>No = GO to <b>8-10</b>.</p>
<p><b>8-9 CHECK TEMPERATURE DIFFERENCE BETWEEN BATTERY TEMPERATURE SENSORS</b></p> <ul style="list-style-type: none"> <li>• With key ON, monitor BCM PIDs TMPSEN1, TMPSEN2, TMPSEN3, and TMPSEN4.</li> </ul>	<p>Yes = GO to <b>8-10</b>.</p>

(Continued)

**DIAGNOSIS AND TESTING (Continued)****ROUTINE 8: VEHICLE DOES NOT CHARGE (LEAD ACID VEHICLES)**

TEST STEP	ACTION TO TAKE
<ul style="list-style-type: none"> <li>Is there a temperature difference of greater than 7°C (13°F) between the temperature sensor that is below 5°C (41°F) and the other temperature sensors?</li> </ul>	No = CONNECT the vehicle to the power control station (PCS) to warm the traction battery to a temperature greater than 7°C (45°F). MONITOR the TMPSEN PIDs while the vehicle is connected to the PCS. If the temperature of the battery temperature sensor that was less than 5°C (41°F) does not increase, GO to <b>8-11</b> .
<p><b>8-10 CHECK BATTERY TEMPERATURE SENSOR (UNDERTEMPERATURE CONDITION)</b></p> <ul style="list-style-type: none"> <li>Remove the traction battery and connect Traction Battery High-Voltage Lockout and Diagnostic Tool to the traction battery high-voltage two-pin C3994M.</li> <li>Connect Traction Battery High Voltage Service Cord to traction battery support tray in-line C1935F and in-line C1935M.</li> </ul> <p> <b>WARNING: The traction battery contains high-voltage components and wiring. High-voltage insulated safety gloves and face shield must be worn when carrying out the following steps. Failure to follow this warning may result in severe personal injury or death.</b></p> <ul style="list-style-type: none"> <li>Connect Traction Battery Low Voltage Service Cord to traction battery support tray in-line C1939F and in-line C1939M.</li> <li>With key OFF, disconnect the battery temperature sensor in question and one of the other temperature sensors.</li> <li>Connect jumper wires between the connector for the temperature sensor in question and the known good temperature sensor that was disconnected.</li> <li>With key ON, monitor battery control module (BCM) PIDs TMPSEN1, TMPSEN2, TMPSEN3, and TMPSEN4.</li> <li>Does the TMPSEN PID that indicated less than 5°C (41°F) still indicate less than 5°C (41°F)?</li> </ul>	Yes = REPLACE the BCM. REFER to <a href="#">Section 414-03A</a> . No = REPLACE the battery temperature sensor in question.
<p><b>8-11 CHARGE TRACTION BATTERY TO FULL STATE OF CHARGE (SOC)</b></p> <ul style="list-style-type: none"> <li>Disconnect and reconnect the 12-volt auxiliary battery negative cable.</li> </ul> <p><b>NOTE:</b> If the EMG__PO PID indicates ENABLE after pressing the START button on the power control station (PCS), GO to <b>8-13</b>.</p> <ul style="list-style-type: none"> <li>Charge the traction battery to full SOC.</li> <li>With key OFF and vehicle on-charge, monitor BCM PIDs EMG__PO and BCM__OP.</li> <li>Does the BCM__OP PID still indicate 96 (no charge-EPO detected)?</li> </ul>	Yes = REPEAT this test step. The traction battery has not reached full SOC. No = System OK.
<p><b>8-12 CHECK EMERGENCY POWER OFF (EPO) SIGNAL TO BATTERY CONTROL MODULE (BCM)</b></p> <ul style="list-style-type: none"> <li>Remove the traction battery and connect Traction Battery High-Voltage Lockout and Diagnostic Tool to the traction battery high-voltage two-pin C3994M.</li> </ul>	Yes = GO to <b>8-13</b> .

(Continued)

**DIAGNOSIS AND TESTING (Continued)****ROUTINE 8: VEHICLE DOES NOT CHARGE (LEAD ACID VEHICLES)**

TEST STEP	ACTION TO TAKE
<p> <b>WARNING: The traction battery contains high-voltage components and wiring. High-voltage insulated safety gloves and face shield must be worn when carrying out the following steps. Failure to follow this warning may result in severe personal injury or death.</b></p> <ul style="list-style-type: none"> <li>• Connect Traction Battery High Voltage Service Cord to traction battery support tray in-line C1935F and in-line C1935M.</li> <li>• Connect Traction Battery Low Voltage Service Cord to traction battery support tray in-line C1939F and in-line C1939M.</li> <li>• Connect 104-Pin Breakout Box (BOB) to BCM and BCM C1986, C1987 using the BCM/TIM BOB Adapter Cable and Overlay.</li> <li>• With key ON, monitor BCM PID EMG_PO.</li> <li>• Connect a jumper wire between BOB pins A10 and A18.</li> <li>• <b>Does the EMG_PO PID indicate DISABLE?</b></li> </ul>	<p>No = REPLACE the BCM.</p> <p>REFER to <a href="#">Section 414-03A</a>.</p>
<p><b>8-13 CHECK CIRCUIT 3006 (P/LG) FOR OPEN</b></p> <ul style="list-style-type: none"> <li>• With key OFF, disconnect contactor box C1982 and measure the resistance of the P/LG wire between pin 9 on contactor box C1982 and BOB pin A18.</li> <li>• <b>Is the resistance less than 5 ohms?</b></li> </ul>	<p>Yes = REPLACE the contactor box. REFER to <a href="#">Section 414-03A</a>.</p> <p>No = REPAIR the P/LG wire.</p>
<p><b>8-14 CHECK CHARGER PILOT SIGNAL CIRCUIT FOR OPEN</b></p> <ul style="list-style-type: none"> <li>• Disengage the locks on the charger inlet connector, push the swing plate forward, and hold the swing plate in the forward position to access the terminals on the charger inlet connector.</li> <li>• With key OFF, measure the resistance between pin 5 (R wire) on charger inlet C5000 and ground.</li> <li>• <b>Is the resistance greater than 2.5 megaohms?</b></li> </ul>	<p>Yes = GO to <b>8-15</b>.</p> <p>No = GO to <b>8-16</b>.</p>
<p><b>8-15 CHECK CIRCUIT 3984 (R) FOR OPEN</b></p> <ul style="list-style-type: none"> <li>• With key OFF, disconnect traction battery charger C1993 and measure the resistance of the R wire between pin 5 on traction battery charger C1993 and pin 5 on charger inlet C5000.</li> <li>• <b>Is the resistance less than 5 ohms?</b></li> </ul>	<p>Yes = REPLACE the traction battery charger. REFER to <a href="#">Section 414-03A</a>.</p> <p>No = REPAIR the R wire.</p>
<p><b>8-16 CHECK NEUTRAL CIRCUIT FOR OPEN</b></p> <ul style="list-style-type: none"> <li>• With key OFF, measure the resistance between pin 7 (DG wire) on charger inlet C5000 and ground.</li> <li>• <b>Is the resistance greater than 100 ohms?</b></li> </ul>	<p>Yes = GO to <b>8-17</b>.</p> <p>No = GO to <b>8-18</b>.</p>
<p><b>8-17 CHECK CIRCUIT 3174 (DG) FOR OPEN</b></p> <ul style="list-style-type: none"> <li>• With key OFF, disconnect traction battery charger C1938 and measure the resistance of the DG wire between pin 7 on charger inlet C5000 and traction battery charger C1938.</li> <li>• <b>Is the resistance less than 5 ohms?</b></li> </ul>	<p>Yes = REPLACE the traction battery charger. REFER to <a href="#">Section 414-03A</a>.</p> <p>No = REPLACE the charger inlet. REFER to <a href="#">Section 414-03A</a>.</p>
<p><b>8-18 CHECK CIRCUITS 3172 (O) AND 3173 (W) FOR OPEN(S)</b></p> <ul style="list-style-type: none"> <li>• With key OFF, disconnect traction battery charger C1938 and measure the resistance of the O wire between pin 4 on charger inlet C5000 and traction battery charger C1938.</li> <li>• With key OFF, measure the resistance of the W wire between pin 3 on charger inlet C5000 and traction battery charger C1938.</li> <li>• <b>Are the resistances less than 5 ohms?</b></li> </ul>	<p>Yes = GO to <b>8-19</b>.</p> <p>No = REPLACE the charger inlet. REFER to <a href="#">Section 414-03A</a>.</p>
<p><b>8-19 CHECK CIRCUITS 3002 (O/LB) AND 3990 (LB/R) (OUTSIDE OF TRACTION BATTERY SUPPORT TRAY) FOR OPEN(S)</b></p>	

(Continued)



**DIAGNOSIS AND TESTING (Continued)****ROUTINE 8: VEHICLE DOES NOT CHARGE (LEAD ACID VEHICLES)**

TEST STEP	ACTION TO TAKE
<ul style="list-style-type: none"> <li>With key OFF, disconnect traction battery support tray in-line C1939 and connect 104-Pin Breakout Box (BOB) to in-line C1939M using Traction Battery Low Voltage Service Cord; do not connect Traction Battery Low Voltage Service Cord to in-line C1939F.</li> <li>With key OFF, disconnect traction battery charger C1991 and C1993.</li> <li>With key OFF, measure the resistance of the O/LB wire between pin 4 on traction battery charger C1991 and BOB pin 61.</li> <li>With key OFF, measure the resistance of the LB/R wire between pin 2 on traction battery charger C1993 and BOB pin 28.</li> <li><b>Are the resistances less than 5 ohms?</b></li> </ul>	<p>Yes = GO to <b>8-20</b>.</p> <p>No = REPAIR the wire(s) in question.</p>
<p><b>8-20 CHECK CIRCUITS 3002 (O/LB) AND 3990 (LB/R) (OUTSIDE OF TRACTION BATTERY SUPPORT TRAY) FOR SHORT(S) TO GROUND</b></p> <ul style="list-style-type: none"> <li>With key OFF, measure the resistance between BOB pins 28, 61 and ground (BOB pin 65).</li> <li><b>Are the resistances greater than 10,000 ohms?</b></li> </ul>	<p>Yes = GO to <b>8-21</b>.</p> <p>No = REPAIR the wire(s) in question.</p>
<p><b>8-21 CHECK CIRCUITS 3002 (O/LB) AND 3990 (LB/R) (INSIDE OF TRACTION BATTERY SUPPORT TRAY) FOR OPEN</b></p> <ul style="list-style-type: none"> <li>Disconnect BOB from in-line C1939M, remove the traction battery, and connect Traction Battery High-Voltage Lockout and Diagnostic Tool to the traction battery high-voltage two-pin C3994M.</li> <li>Connect BOB to traction battery support tray in-line C1939F using Traction Battery Low Voltage Service Cord; do not connect Traction Battery Low Voltage Service Cord to in-line C1939M.</li> </ul> <p> <b>WARNING: The traction battery contains high-voltage components and wiring. High-voltage insulated safety gloves and face shield must be worn when carrying out the following steps. Failure to follow this warning may result in severe personal injury or death.</b></p> <ul style="list-style-type: none"> <li>With key OFF, disconnect BCM C1986 and C1987.</li> <li>Measure the resistance of the O/LB wire between pin 5 on BCM C1987 and BOB pin 61.</li> <li>Measure the resistance of the LB/R wire between pin 35 on BCM C1986 and BOB pin 28.</li> <li><b>Are the resistances less than 5 ohms?</b></li> </ul>	<p>Yes = GO to <b>8-22</b>.</p> <p>No = REPAIR the wire(s) in question.</p>
<p><b>8-22 CHECK CIRCUITS 3002 (O/LB) AND 3990 (LB/R) (INSIDE OF TRACTION BATTERY SUPPORT TRAY) FOR SHORT(S) TO GROUND</b></p> <ul style="list-style-type: none"> <li>With key OFF, measure the resistance between BOB pins 28, 61 and ground (BOB pin 65).</li> <li><b>Are the resistances greater than 10,000 ohms?</b></li> </ul>	<p>Yes = REPLACE the traction battery charger. REFER to <a href="#">Section 414-03A</a>.</p> <p>No = REPAIR the wire(s) in question.</p>
<p><b>8-23 VERIFY POWER CONTROL STATION (PCS) OPERATION</b></p> <ul style="list-style-type: none"> <li>Perform Power Control Station (PCS) Operation Verification Test. Refer to Traction Battery Charging/Heating System in <a href="#">Section 414-03A</a>.</li> <li><b>Is the PCS OK?</b></li> </ul>	<p>Yes = GO to <b>8-24</b>.</p> <p>No = CARRY OUT the required action as indicated in the Power Control Station (PCS) Operation Verification Test.</p>
<p><b>8-24 CHECK CIRCUIT 3009 (O/R) (OUTSIDE OF TRACTION BATTERY SUPPORT TRAY) FOR OPEN</b></p>	

(Continued)

**DIAGNOSIS AND TESTING (Continued)****ROUTINE 8: VEHICLE DOES NOT CHARGE (LEAD ACID VEHICLES)**

TEST STEP	ACTION TO TAKE
<ul style="list-style-type: none"> <li>With key OFF, disconnect traction battery support tray in-line C1939 and connect 104-Pin Breakout Box (BOB) to in-line C1939M using Traction Battery Low Voltage Service Cord; do not connect Traction Battery Low Voltage Service Cord to in-line C1939F.</li> <li>With key OFF, disconnect traction battery charger C1993.</li> <li>With key OFF, measure the resistance of the O/R wire between pin 7 on traction battery charger C1993 and BOB pin 56.</li> <li><b>Is the resistance less than 5 ohms?</b></li> </ul>	<p>Yes = GO to <b>8-25</b>.</p> <p>No = REPAIR the O/R wire.</p>
<p><b>8-25 CHECK CIRCUIT 3009 (O/R) (OUTSIDE OF TRACTION BATTERY SUPPORT TRAY) FOR SHORT TO GROUND</b></p> <ul style="list-style-type: none"> <li>With key OFF, measure the resistance between BOB pins 56 and ground (BOB pin 65).</li> <li><b>Is the resistance greater than 10,000 ohms?</b></li> </ul>	<p>Yes = GO to <b>8-26</b>.</p> <p>No = REPAIR the O/R wire.</p>
<p><b>8-26 CHECK CIRCUIT 3009 (O/R) (INSIDE OF TRACTION BATTERY SUPPORT TRAY) FOR OPEN</b></p> <ul style="list-style-type: none"> <li>Disconnect BOB from in-line C1939M, remove the traction battery, and connect Traction Battery High-Voltage Lockout and Diagnostic Tool to the traction battery high-voltage two-pin C3994M.</li> </ul> <p><b>⚠ WARNING: The traction battery contains high-voltage components and wiring. High-voltage insulated safety gloves and face shield must be worn when carrying out the following steps. Failure to follow this warning may result in severe personal injury or death.</b></p> <ul style="list-style-type: none"> <li>Connect BOB to traction battery support tray in-line C1939F using Traction Battery Low Voltage Service Cord; do not connect Traction Battery Low Voltage Service Cord to in-line C1939M.</li> <li>With key OFF, disconnect BCM C1986.</li> <li>Measure the resistance of the O/R wire between pin 6 on BCM C1986 and BOB pin 56.</li> <li><b>Is the resistance less than 5 ohms?</b></li> </ul>	<p>Yes = GO to <b>8-27</b>.</p> <p>No = REPAIR the O/R wire.</p>
<p><b>8-27 CHECK CIRCUIT 3009 (O/R) (INSIDE OF TRACTION BATTERY SUPPORT TRAY) FOR SHORT TO GROUND</b></p> <ul style="list-style-type: none"> <li>With key OFF, measure the resistance between BOB pins 56 and ground (BOB pin 65).</li> <li><b>Is the resistance greater than 10,000 ohms?</b></li> </ul>	<p>Yes = REPLACE the traction battery charger. REFER to <a href="#">Section 414-03A</a>.</p> <p>No = REPAIR the O/R wire.</p>
<p><b>8-28 CHECK CHARGER CORD INPUT STATUS</b></p> <p><b>NOTE:</b> Verify the power control station (PCS) charger cord is connected to the charger inlet before carrying out this test step.</p> <ul style="list-style-type: none"> <li>With key OFF, connect the PCS to the charger inlet connector and monitor BCM PID CHGCORD.</li> <li><b>Does the CHGCORD PID indicate IN?</b></li> </ul>	<p>Yes = REPLACE the traction battery charger. REFER to <a href="#">Section 414-03A</a>.</p> <p>No = GO to <b>8-29</b>.</p>
<p><b>8-29 CHECK CHARGER INLET</b></p> <ul style="list-style-type: none"> <li>With key OFF, disconnect in-line C1969 (located on the chassis next to the right headlamp inside the underhood compartment).</li> <li>With key OFF, connect the PCS to the charger inlet connector and measure the resistance between the Y wire and BK wire on in-line C1969F.</li> <li><b>Is the resistance less than 5 ohms?</b></li> </ul>	<p>Yes = GO to <b>8-30</b>.</p> <p>No = REPLACE the charger inlet. REFER to <a href="#">Section 414-03A</a>.</p>
<p><b>8-30 CHECK CIRCUIT 3404 (Y) (OUTSIDE OF TRACTION BATTERY SUPPORT TRAY) FOR OPEN</b></p>	

(Continued)

**DIAGNOSIS AND TESTING (Continued)****ROUTINE 8: VEHICLE DOES NOT CHARGE (LEAD ACID VEHICLES)**

TEST STEP	ACTION TO TAKE
<ul style="list-style-type: none"> <li>With key OFF, disconnect traction battery support tray in-line C1939 and connect 104-Pin Breakout Box (BOB) to in-line C1939M using Traction Battery Low Voltage Service Cord; do not connect Traction Battery Low Voltage Service Cord to in-line C1939F.</li> <li>With key OFF, measure the resistance of the Y wire between BOB pin 54 and in-line 1969M.</li> <li><b>Is the resistance less than 5 ohms?</b></li> </ul>	Yes = GO to <b>8-31</b> .  No = REPAIR the Y wire.
<b>8-31 CHECK CIRCUIT 3404 (Y) (INSIDE OF TRACTION BATTERY SUPPORT TRAY) FOR OPEN</b> <ul style="list-style-type: none"> <li>Disconnect BOB from in-line C1939M, remove the traction battery, and connect Traction Battery High-Voltage Lockout and Diagnostic Tool to the traction battery high-voltage two-pin C3994M.</li> </ul> <p><b>⚠ WARNING: The traction battery contains high-voltage components and wiring. High-voltage insulated safety gloves and face shield must be worn when carrying out the following steps. Failure to follow this warning may result in severe personal injury or death.</b></p> <ul style="list-style-type: none"> <li>Connect BOB to traction battery support tray in-line C1939F using Traction Battery Low Voltage Service Cord; do not connect Traction Battery Low Voltage Service Cord to in-line C1939M.</li> <li>With key OFF, disconnect BCM C1987.</li> <li>Measure the resistance of the Y wire between pin 12 on BCM C1987 and BOB pin 54.</li> <li><b>Is the resistance less than 5 ohms?</b></li> </ul>	Yes = REPLACE the BCM. REFER to <a href="#">Section 414-03A</a> .  No = REPAIR the Y wire.

**ROUTINE 9: VEHICLE DOES NOT CHARGE (NIMH VEHICLES)**

TEST STEP	ACTION TO TAKE
<b>9-1 CHECK STATUS OF BATTERY CONTROL MODULE (BCM) OPERATING STATE</b> <ul style="list-style-type: none"> <li>Verify the ignition key is in the OFF position and the gear selector is in the P (Park) position.</li> <li>Connect the vehicle to a power control station (PCS) and press the START button to begin charging.</li> </ul> <p><b>NOTE:</b> Wait approximately five minutes to allow the BCM__OP PID to be set.</p> <ul style="list-style-type: none"> <li>With key OFF and vehicle on-charge, monitor BCM PID BCM__OP. Check for the following numbers:               <ul style="list-style-type: none"> <li>—48 (shutdown-low battery module voltage)</li> <li>—83 (no charge-battery overtemperature)</li> <li>—84 (no charge-battery undertemperature)</li> <li>—85 (no charge-high temperature delta)</li> <li>—87 (no charge-battery full)</li> <li>—96 (no charge-EPO detected)</li> <li>—99 (no charge-line capacity out of range)</li> <li>—101 (no charge-no AC to charger)</li> </ul> </li> <li><b>Does the BCM__OP PID indicate 48, 83, 84, 85, 87, 96, 99, or 101?</b></li> </ul>	Yes = If 48, GO to <b>9-2</b> . If 83, GO to <b>9-5</b> . If 84, GO to <b>9-8</b> . If 85, GO to <b>9-11</b> . If 87, the traction battery is at full state of charge (SOC). System OK. If 96, GO to <b>9-12</b> . If 99, GO to <b>9-15</b> . If 101, GO to <b>9-28</b> .  No = GO to <b>9-33</b> .
<b>9-2 CHARGE TRACTION BATTERY TO FULL STATE OF CHARGE (SOC)</b> <ul style="list-style-type: none"> <li>Disconnect and reconnect the 12-volt auxiliary battery negative cable.</li> </ul>	Yes = GO to <b>9-3</b> .

(Continued)

**DIAGNOSIS AND TESTING (Continued)****ROUTINE 9: VEHICLE DOES NOT CHARGE (NIMH VEHICLES)**

TEST STEP	ACTION TO TAKE
<ul style="list-style-type: none"> <li>Charge the traction battery to full SOC.</li> <li>With key ON, monitor BCM PID BCM__OP.</li> <li><b>Does the BCM__OP PID still indicate 48 (shutdown-low battery module voltage)?</b></li> </ul>	No = System OK.
<b>9-3 CHECK STATUS OF TRACTION BATTERY MODULES BY CARRYING OUT THE BATTERY MODULE DIAGNOSTIC TEST</b> <ul style="list-style-type: none"> <li>With key ON, carry out the Battery Module Diagnostic Test. Refer to the procedure in Traction Battery System.</li> </ul>	Yes = REPLACE the battery module(s) in question. REFER to <a href="#">Section 414-03B</a> . No= CHARGE the traction battery to full (SOC). CHECK the BCM_OP PID. IF the BCM_OP PID still indicates 48. REPLACE the BCM. REFER to <a href="#">Section 414-03B</a> .
<b>9-4 CHECK TRACTION BATTERY TEMPERATURE SENSORS FOR OVERTEMPERATURE CONDITION</b> <ul style="list-style-type: none"> <li>With key ON, monitor BCM PIDs TMPSEN1, TMPSEN2, and TMPSEN3.</li> <li><b>Do any of the TMPSEN PIDs indicate greater than 45°C (113°F)?</b></li> </ul>	Yes = PARK the vehicle indoors in a cooler environment. CONNECT the vehicle to a power control station (PCS) to allow the traction battery fans to operate. GO to <b>9-6</b> . No = DISCONNECT and RECONNECT the 12-volt auxiliary battery negative cable and RECHECK the BCM__OP PID. If the BCM__OP PID still indicates 83, REPLACE the BCM. REFER to <a href="#">Section 414-03B</a> .
<b>9-5 CHECK IF OVERTEMPERATURE STATE IS CAUSED BY AN ACTUAL OVERTEMPERATURE CONDITION</b> <p><b>NOTE:</b> Allow adequate time for vehicle to cool before checking for temperature decrease.</p> <ul style="list-style-type: none"> <li>While vehicle is connected to the PCS, monitor BCM PIDs TMPSEN1, TMPSEN2, and TMPSEN3.</li> <li><b>Do the TMPSEN PIDs that were greater than 45°C (113°F) decrease?</b></li> </ul>	Yes = ALLOW temperature(s) to decrease below 42°C (108°F). System OK. No = GO to <b>9-6</b> .
<b>9-6 CHECK BATTERY TEMPERATURE SENSORS</b> <ul style="list-style-type: none"> <li>Remove the traction battery and connect Traction Battery High-Voltage Lockout and Diagnostic Tool to the traction battery high-voltage two-pin C3994M.</li> </ul>	Yes = REPLACE the BCM. REFER to <a href="#">Section 414-03B</a> .

(Continued)

**DIAGNOSIS AND TESTING (Continued)****ROUTINE 9: VEHICLE DOES NOT CHARGE (NIMH VEHICLES)**

TEST STEP	ACTION TO TAKE
<p><b>⚠ WARNING: The traction battery contains high-voltage components and wiring. High-voltage insulated safety gloves and face shield must be worn when carrying out the following steps. Failure to follow this warning may result in severe personal injury or death.</b></p> <ul style="list-style-type: none"> <li>• Connect Traction Battery High Voltage Service Cord to traction battery support tray in-line C1935F and in-line C1935M.</li> <li>• Connect Traction Battery Low Voltage Service Cord to traction battery support tray in-line C1939F and in-line C1939M.</li> <li>• With key OFF, disconnect the battery temperature sensor in question and one of the other temperature sensors.</li> <li>• Connect jumper wires between the connector for the temperature sensor in question and the known good temperature sensor that was disconnected.</li> <li>• With key ON, monitor BCM PIDs TMPSEN1, TMPSEN2, and TMPSEN3.</li> <li>• <b>Does the TMPSEN PID that indicated greater than 45°C (113°F) still indicate the same value?</b></li> </ul>	<p>No = REPLACE the battery temperature sensor in question.</p>
<p><b>9-7 CHECK TRACTION BATTERY TEMPERATURE SENSORS FOR UNDERTEMPERATURE CONDITION</b></p> <ul style="list-style-type: none"> <li>• With key ON, monitor BCM PIDs TMPSEN1, TMPSEN2, and TMPSEN3.</li> <li>• <b>Do any of the TMPSEN PIDs indicate less than -25°C (-13°F)?</b></li> </ul>	<p>Yes = PARK the vehicle indoors in a warmer environment. CONNECT the vehicle to a power control station (PCS) to allow self-heating. GO to <b>9-8</b>.</p> <p>No = DISCONNECT and RECONNECT the 12-volt auxiliary battery negative cable and RECHECK the BCM_OP PID. If the BCM_OP PID still indicates 84, REPLACE the BCM. REFER to <a href="#">Section 414-03B</a>.</p>
<p><b>9-8 CHECK IF UNDERTEMPERATURE STATE IS CAUSED BY AN ACTUAL UNDERTEMPERATURE CONDITION</b></p> <p><b>NOTE:</b> Allow adequate time for vehicle to warm before checking for temperature increase.</p> <ul style="list-style-type: none"> <li>• While vehicle is connected to the PCS, monitor BCM PIDs TMPSEN1, TMPSEN2, and TMPSEN3.</li> <li>• <b>Do the TMPSEN PIDs that were less than -25°C (-13°F) increase?</b></li> </ul>	<p>Yes = ALLOW temperature(s) to increase above -24°C (-11°F). System OK.</p> <p>No = GO to <b>9-9</b>.</p>
<p><b>9-9 CHECK BATTERY TEMPERATURE SENSORS</b></p> <ul style="list-style-type: none"> <li>• Remove the traction battery and connect Traction Battery High-Voltage Lockout and Diagnostic Tool to the traction battery high-voltage two-pin C3994M.</li> </ul>	<p>Yes = REPLACE the BCM. REFER to <a href="#">Section 414-03B</a>.</p>

(Continued)

**DIAGNOSIS AND TESTING (Continued)****ROUTINE 9: VEHICLE DOES NOT CHARGE (NIMH VEHICLES)**

TEST STEP	ACTION TO TAKE
<p><b>⚠ WARNING: The traction battery contains high-voltage components and wiring. High-voltage insulated safety gloves and face shield must be worn when carrying out the following steps. Failure to follow this warning may result in severe personal injury or death.</b></p> <ul style="list-style-type: none"> <li>• Connect Traction Battery High Voltage Service Cord to traction battery support tray in-line C1935F and in-line C1935M.</li> <li>• Connect Traction Battery Low Voltage Service Cord to traction battery support tray in-line C1939F and in-line C1939M.</li> <li>• With key OFF, disconnect the battery temperature sensor in question and one of the other temperature sensors.</li> <li>• Connect jumper wires between the connector for the temperature sensor in question and the known good temperature sensor that was disconnected.</li> <li>• With key ON, monitor BCM PIDs TMPSEN1, TMPSEN2, and TMPSEN3.</li> <li>• <b>Does the TMPSEN PID that indicated less than -25°C (-13°F) still indicate the same value?</b></li> </ul>	<p>No = REPLACE the battery temperature sensor in question.</p>
<p><b>9-10 CHECK BATTERY TEMPERATURE SENSOR (HIGH TEMPERATURE DELTA CONDITION)</b></p> <ul style="list-style-type: none"> <li>• Remove the traction battery and connect Traction Battery High-Voltage Lockout and Diagnostic Tool to the traction battery high-voltage two-pin C3994M.</li> <li>• Connect Traction Battery High Voltage Service Cord to traction battery support tray in-line C1935F and in-line C1935M.</li> </ul> <p><b>⚠ WARNING: The traction battery contains high-voltage components and wiring. High-voltage insulated safety gloves and face shield must be worn when carrying out the following steps. Failure to follow this warning may result in severe personal injury or death.</b></p> <ul style="list-style-type: none"> <li>• Connect Traction Battery Low Voltage Service Cord to traction battery support tray in-line C1939F and in-line C1939M.</li> <li>• With key OFF, disconnect the battery temperature sensor in question and one of the other temperature sensors.</li> <li>• Connect jumper wires between the connector for the temperature sensor in question and the known good temperature sensor that was disconnected.</li> <li>• With key ON, monitor battery control module (BCM) PIDs TMPSEN1, TMPSEN2, and TMPSEN3.</li> <li>• <b>Does the TMPSEN PID that indicated a greater than 20°C (36°F) difference from the other TMPSEN PIDs still indicate a greater than 20°C (36°F) difference?</b></li> </ul>	<p>Yes = REPLACE the BCM. REFER to <a href="#">Section 414-03B</a>.</p> <p>No = REPLACE the battery temperature sensor in question.</p>
<p><b>9-11 CHARGE TRACTION BATTERY TO FULL STATE OF CHARGE (SOC)</b></p> <ul style="list-style-type: none"> <li>• Disconnect and reconnect the 12-volt auxiliary battery negative cable.</li> </ul> <p><b>NOTE:</b> If the EMG__PO indicates ENABLE after pressing the START button on the power control station (PCS), GO to <b>9-13</b>.</p> <ul style="list-style-type: none"> <li>• Charge the traction battery to full SOC.</li> <li>• With key OFF and vehicle on-charge, monitor BCM PIDs EMG__PO and BCM__OP.</li> <li>• <b>Does the BCM__OP PID still indicate 96 (no charge-EPO detected)?</b></li> </ul>	<p>Yes = REPEAT this test step. The traction battery has not reached full SOC.</p> <p>No = System OK.</p>

(Continued)

**DIAGNOSIS AND TESTING (Continued)****ROUTINE 9: VEHICLE DOES NOT CHARGE (NIMH VEHICLES)**

TEST STEP	ACTION TO TAKE
<p><b>9-12 CHECK EMERGENCY POWER OFF (EPO) SIGNAL TO BATTERY CONTROL MODULE (BCM)</b></p> <ul style="list-style-type: none"> <li>Remove the traction battery and connect Traction Battery High-Voltage Lockout and Diagnostic Tool to the traction battery high-voltage two-pin C3994M.</li> </ul> <p> <b>WARNING: The traction battery contains high-voltage components and wiring. High-voltage insulated safety gloves and face shield must be worn when carrying out the following steps. Failure to follow this warning may result in severe personal injury or death.</b></p> <ul style="list-style-type: none"> <li>Connect Traction Battery High Voltage Service Cord to traction battery support tray in-line C1935F and in-line C1935M.</li> <li>Connect Traction Battery Low Voltage Service Cord to traction battery support tray in-line C1939F and in-line C1939M.</li> <li>Connect 104-Pin Breakout Box (BOB) to BCM and BCM C1986, C1987 using the BCM/TIM BOB Adapter Cable and Overlay.</li> <li>With key ON, monitor BCM PID EMG_PO.</li> <li>Connect a jumper wire between BOB pins A10 and A18.</li> <li><b>Does the EMG_PO PID indicate DISABLE?</b></li> </ul>	<p>Yes = GO to <b>9-13</b>.</p> <p>No = REPLACE the BCM.</p> <p>REFER to <a href="#">Section 414-03B</a>.</p>
<p><b>9-13 CHECK CIRCUIT 3006 (P/LG) FOR OPEN</b></p> <ul style="list-style-type: none"> <li>With key OFF, disconnect contactor box C1982 and measure the resistance of the P/LG wire between pin 9 on contactor box C1982 and BOB pin A18.</li> <li><b>Is the resistance less than 5 ohms?</b></li> </ul>	<p>Yes = REPLACE the contactor box. REFER to <a href="#">Section 414-03B</a>.</p> <p>No = REPAIR the P/LG wire.</p>
<p><b>9-14 CHECK CHARGER PILOT SIGNAL AT TRACTION BATTERY CHARGER</b></p> <ul style="list-style-type: none"> <li>With key OFF, disconnect traction battery charger C1993.</li> <li>Connect the vehicle to a power control station (PCS).</li> <li>With key OFF, measure the voltage between pin 5 (LB/R wire) on traction battery charger C1993 and ground.</li> <li><b>Is the voltage greater than 10 volts?</b></li> </ul>	<p>Yes = GO to <b>9-22</b>.</p> <p>No = GO to <b>9-15</b>.</p>
<p><b>9-15 CHECK CHARGER PILOT SIGNAL AT TRACTION BATTERY SUPPORT TRAY</b></p> <ul style="list-style-type: none"> <li>With key OFF, disconnect traction battery support tray in-line C1939 and connect 104-Pin Breakout Box (BOB) to in-line C1939M using Traction Battery Low Voltage Service Cord; do not connect Traction Battery Low Voltage Service Cord to in-line C1939F.</li> <li>Connect the vehicle to a power control station (PCS).</li> <li>With key OFF, measure the voltage between BOB pin 20 and ground (BOB pin 65).</li> <li><b>Is the voltage greater than 10 volts?</b></li> </ul>	<p>Yes = GO to <b>9-18</b>.</p> <p>No = GO to <b>9-16</b>.</p>
<p><b>9-16 CHECK CIRCUITS 3984 (R) AND 4009 (LB/R) (OUTSIDE OF TRACTION BATTERY SUPPORT TRAY) FOR OPEN(S)</b></p> <ul style="list-style-type: none"> <li>Disengage the locks on the charger inlet connector, push the swing plate forward, and hold the swing plate in the forward position to access the terminals on the charger inlet connector.</li> <li>With key OFF, measure the resistance of the R wire between pin 5 on charger inlet C5000 and BOB pin 20.</li> <li>With key OFF, measure the resistance of the LB/R wire between pin 5 on traction battery charger C1993 and BOB pin 14.</li> <li><b>Are the resistances less than 5 ohms?</b></li> </ul>	<p>Yes = GO to <b>9-17</b>.</p> <p>No = REPAIR the wire(s) in question.</p>
<p><b>9-17 CHECK CIRCUITS 3984 (R) AND 4009 (LB/R) (OUTSIDE OF TRACTION BATTERY SUPPORT TRAY) FOR SHORT(S) TO GROUND</b></p>	

(Continued)

**DIAGNOSIS AND TESTING (Continued)****ROUTINE 9: VEHICLE DOES NOT CHARGE (NIMH VEHICLES)**

TEST STEP	ACTION TO TAKE
<ul style="list-style-type: none"> <li>With key OFF, measure the resistance between BOB pins 14, 20 and ground (BOB pin 65).</li> <li><b>Are the resistances greater than 10,000 ohms?</b></li> </ul>	Yes = CARRY OUT Pinpoint Test U: Power Control Station (PCS) Operation Verification Test. Refer to Traction Battery Charging/Heating System in <a href="#">Section 414-03B</a> . No = REPAIR the wire(s) in question.
<p><b>9-18 CHECK CIRCUITS 3984 (R) AND 4009 (LB/R) (INSIDE OF TRACTION BATTERY SUPPORT TRAY) FOR OPEN(S)</b></p> <ul style="list-style-type: none"> <li>Disconnect BOB from in-line C1939M, remove the traction battery, and connect Traction Battery High-Voltage Lockout and Diagnostic Tool to the traction battery high-voltage two-pin C3994M.</li> </ul> <p><b>⚠ WARNING: The traction battery contains high-voltage components and wiring. High-voltage insulated safety gloves and face shield must be worn when carrying out the following steps. Failure to follow this warning may result in severe personal injury or death.</b></p> <ul style="list-style-type: none"> <li>Connect BOB to traction battery support tray in-line C1939F using Traction Battery Low Voltage Service Cord; do not connect Traction Battery Low Voltage Service Cord to in-line C1939M.</li> <li>With key OFF, disconnect independent observer module (IOM) C1810 and measure the resistance of the R wire between pin 33 on IOM C1810 and BOB pin 20.</li> <li>With key OFF, measure the resistance of the LB/R wire between pin 34 on IOM C1810 and BOB pin 14.</li> <li><b>Are the resistances less than 5 ohms?</b></li> </ul>	Yes = GO to <b>9-19</b> . No = REPAIR the wire(s) in question.
<p><b>9-19 CHECK CIRCUITS 3984 (R) AND 4009 (LB/R) (INSIDE OF TRACTION BATTERY SUPPORT TRAY) FOR SHORT(S) TO GROUND</b></p> <ul style="list-style-type: none"> <li>With key OFF, measure the resistance between BOB pins 14, 20 and ground (BOB pin 65).</li> <li><b>Are the resistances greater than 10,000 ohms?</b></li> </ul>	Yes = REPLACE the IOM. No = REPAIR the wire(s) in question.
<p><b>9-20 CHECK NEUTRAL CIRCUIT FOR OPEN</b></p> <ul style="list-style-type: none"> <li>With key OFF, measure the resistance between pin 7 (DG wire) on charger inlet C5000 and ground.</li> <li><b>Is the resistance greater than 100 ohms?</b></li> </ul>	Yes = GO to <b>9-21</b> . No = GO to <b>9-22</b> .
<p><b>9-21 CHECK CIRCUIT 3174 (DG) FOR OPEN</b></p> <ul style="list-style-type: none"> <li>With key OFF, disconnect traction battery charger C1938 and measure the resistance of the DG wire between pin 7 on charger inlet C5000 and traction battery charger C1938.</li> <li><b>Is the resistance less than 5 ohms?</b></li> </ul>	Yes = REPLACE the traction battery charger. REFER to <a href="#">Section 414-03B</a> . No = REPLACE the charger inlet. REFER to <a href="#">Section 414-03B</a> .
<p><b>9-22 CHECK CIRCUITS 3172 (O) AND 3173 (W) FOR OPEN(S)</b></p> <ul style="list-style-type: none"> <li>With key OFF, disconnect traction battery charger C1938 and measure the resistance of the O wire between pin 4 on charger inlet C5000 and traction battery charger C1938.</li> <li>With key OFF, measure the resistance of the W wire between pin 3 on charger inlet C5000 and traction battery charger C1938.</li> <li><b>Are the resistances less than 5 ohms?</b></li> </ul>	Yes = GO to <b>9-23</b> . No = REPLACE the charger inlet. REFER to <a href="#">Section 414-03B</a> .

(Continued)



**DIAGNOSIS AND TESTING (Continued)****ROUTINE 9: VEHICLE DOES NOT CHARGE (NIMH VEHICLES)**

TEST STEP	ACTION TO TAKE
<p><b>9-23 CHECK CIRCUITS 3002 (O/LB) AND 3990 (LB/R) (OUTSIDE OF TRACTION BATTERY SUPPORT TRAY) FOR OPEN(S)</b></p> <ul style="list-style-type: none"> <li>• With key OFF, disconnect traction battery support tray in-line C1939 and connect 104-Pin Breakout Box (BOB) to in-line C1939M using Traction Battery Low Voltage Service Cord; do not connect Traction Battery Low Voltage Service Cord to in-line C1939F.</li> <li>• With key OFF, disconnect traction battery charger C1991 and C1993.</li> <li>• With key OFF, measure the resistance of the O/LB wire between pin 4 on traction battery charger C1991 and BOB pin 61.</li> <li>• With key OFF, measure the resistance of the LB/R wire between pin 2 on traction battery charger C1993 and BOB pin 28.</li> <li>• <b>Are the resistances less than 5 ohms?</b></li> </ul>	<p>Yes = GO to <b>9-24</b>.</p> <p>No = REPAIR the wire(s) in question.</p>
<p><b>9-24 CHECK CIRCUITS 3002 (O/LB) AND 3990 (LB/R) (OUTSIDE OF TRACTION BATTERY SUPPORT TRAY) FOR SHORT(S) TO GROUND</b></p> <ul style="list-style-type: none"> <li>• With key OFF, measure the resistance between BOB pins 28, 61 and ground (BOB pin 65).</li> <li>• <b>Are the resistances greater than 10,000 ohms?</b></li> </ul>	<p>Yes = GO to <b>9-25</b>.</p> <p>No = REPAIR the wire(s) in question.</p>
<p><b>9-25 CHECK CIRCUITS 3002 (O/LB) AND 3990 (LB/R) (INSIDE OF TRACTION BATTERY SUPPORT TRAY) FOR OPEN</b></p> <ul style="list-style-type: none"> <li>• Disconnect BOB from in-line C1939M, remove the traction battery, and connect Traction Battery High-Voltage Lockout and Diagnostic Tool to the traction battery high-voltage two-pin C3994M.</li> <li>• Connect BOB to traction battery support tray in-line C1939F using Traction Battery Low Voltage Service Cord; do not connect Traction Battery Low Voltage Service Cord to in-line C1939M.</li> </ul> <p><b>⚠ WARNING: The traction battery contains high-voltage components and wiring. High-voltage insulated safety gloves and face shield must be worn when carrying out the following steps. Failure to follow this warning may result in severe personal injury or death.</b></p> <ul style="list-style-type: none"> <li>• With key OFF, disconnect BCM C1986 and C1987.</li> <li>• Measure the resistance of the O/LB wire between pin 5 on BCM C1987 and BOB pin 61.</li> <li>• Measure the resistance of the LB/R wire between pin 35 on BCM C1986 and BOB pin 28.</li> <li>• <b>Are the resistances less than 5 ohms?</b></li> </ul>	<p>Yes = GO to <b>9-26</b>.</p> <p>No = REPAIR the wire(s) in question.</p>
<p><b>9-26 CHECK CIRCUITS 3002 (O/LB) AND 3990 (LB/R) (INSIDE OF TRACTION BATTERY SUPPORT TRAY) FOR SHORT(S) TO GROUND</b></p> <ul style="list-style-type: none"> <li>• With key OFF, measure the resistance between BOB pins 28, 61 and ground (BOB pin 65).</li> <li>• <b>Are the resistances greater than 10,000 ohms?</b></li> </ul>	<p>Yes = REPLACE the traction battery charger. REFER to <a href="#">Section 414-03B</a>.</p> <p>No = REPAIR the wire(s) in question.</p>
<p><b>9-27 VERIFY POWER CONTROL STATION (PCS) OPERATION</b></p> <ul style="list-style-type: none"> <li>• Carry out the Power Control Station (PCS) Operation Verification Test. Refer to Traction Battery Charging/Heating System in <a href="#">Section 414-03B</a>.</li> <li>• <b>Is the PCS OK?</b></li> </ul>	<p>Yes = GO to <b>9-28</b>.</p> <p>No = CARRY OUT the required action as indicated in the Power Control Station (PCS) Operation Verification Test.</p>

(Continued)

**DIAGNOSIS AND TESTING (Continued)****ROUTINE 9: VEHICLE DOES NOT CHARGE (NIMH VEHICLES)**

TEST STEP	ACTION TO TAKE
<p><b>9-28 CHECK CIRCUIT 3009 (O/R) (OUTSIDE OF TRACTION BATTERY SUPPORT TRAY) FOR OPEN</b></p> <ul style="list-style-type: none"> <li>• With key OFF, disconnect traction battery support tray in-line C1939 and connect 104-Pin Breakout Box (BOB) to in-line C1939M using Traction Battery Low Voltage Service Cord; do not connect Traction Battery Low Voltage Service Cord to in-line C1939F.</li> <li>• With key OFF, disconnect traction battery charger C1993.</li> <li>• With key OFF, measure the resistance of the O/R wire between pin 7 on traction battery charger C1993 and BOB pin 56.</li> <li>• <b>Is the resistance less than 5 ohms?</b></li> </ul>	<p>Yes = GO to <b>9-29</b>.</p> <p>No = REPAIR the O/R wire.</p>
<p><b>9-29 CHECK CIRCUIT 3009 (O/R) (OUTSIDE OF TRACTION BATTERY SUPPORT TRAY) FOR SHORT TO GROUND</b></p> <ul style="list-style-type: none"> <li>• With key OFF, measure the resistance between BOB pins 56 and ground (BOB pin 65).</li> <li>• <b>Is the resistance greater than 10,000 ohms?</b></li> </ul>	<p>Yes = GO to <b>9-30</b>.</p> <p>No = REPAIR the O/R wire.</p>
<p><b>9-30 CHECK CIRCUIT 3009 (O/R) (INSIDE OF TRACTION BATTERY SUPPORT TRAY) FOR OPEN</b></p> <ul style="list-style-type: none"> <li>• Disconnect BOB from in-line C1939M, remove the traction battery, and connect Traction Battery High-Voltage Lockout and Diagnostic Tool to the traction battery high-voltage two-pin C3994M.</li> </ul> <p><b>⚠ WARNING: The traction battery contains high-voltage components and wiring. High-voltage insulated safety gloves and face shield must be worn when carrying out the following steps. Failure to follow this warning may result in severe personal injury or death.</b></p> <ul style="list-style-type: none"> <li>• Connect BOB to traction battery support tray in-line C1939F using Traction Battery Low Voltage Service Cord; do not connect Traction Battery Low Voltage Service Cord to in-line C1939M.</li> <li>• With key OFF, disconnect BCM C1986.</li> <li>• Measure the resistance of the O/R wire between pin 6 on BCM C1986 and BOB pin 56.</li> <li>• <b>Is the resistance less than 5 ohms?</b></li> </ul>	<p>Yes = GO to <b>9-31</b>.</p> <p>No = REPAIR the O/R wire.</p>
<p><b>9-31 CHECK CIRCUIT 3009 (O/R) (INSIDE OF TRACTION BATTERY SUPPORT TRAY) FOR SHORT TO GROUND</b></p> <ul style="list-style-type: none"> <li>• With key OFF, measure the resistance between BOB pins 56 and ground (BOB pin 65).</li> <li>• <b>Is the resistance greater than 10,000 ohms?</b></li> </ul>	<p>Yes = REPLACE the traction battery charger. REFER to <a href="#">Section 414-03B</a>.</p> <p>No = REPAIR the O/R wire.</p>
<p><b>9-32 CHECK CHARGER CORD INPUT STATUS</b></p> <p><b>NOTE:</b> Verify the power control station (PCS) charger cord is connected to the charger inlet before carrying out this test step.</p> <ul style="list-style-type: none"> <li>• With key OFF, connect the PCS to the charger inlet connector and monitor BCM PID CHGCORD.</li> <li>• <b>Does the CHGCORD PID indicate IN?</b></li> </ul>	<p>Yes = REPLACE the traction battery charger. REFER to <a href="#">Section 414-03B</a>.</p> <p>No = GO to <b>9-35</b>.</p>
<p><b>9-33 CHECK CHARGER INLET</b></p> <ul style="list-style-type: none"> <li>• With key OFF, disconnect in-line C1969 (located on the chassis next to the right headlamp inside the underhood compartment).</li> <li>• With key OFF, connect the PCS to the charger inlet connector and measure the resistance between the Y wire and BK wire on in-line C1969F.</li> <li>• <b>Is the resistance less than 5 ohms?</b></li> </ul>	<p>Yes = GO to <b>9-34</b>.</p> <p>No = REPLACE the charger inlet. REFER to <a href="#">Section 414-03B</a>.</p>

(Continued)

**DIAGNOSIS AND TESTING (Continued)****ROUTINE 9: VEHICLE DOES NOT CHARGE (NIMH VEHICLES)**

TEST STEP	ACTION TO TAKE
<b>9-34 CHECK CIRCUIT 3404 (Y) (OUTSIDE OF TRACTION BATTERY SUPPORT TRAY) FOR OPEN</b> <ul style="list-style-type: none"> <li>With key OFF, disconnect traction battery support tray in-line C1939 and connect 104-Pin Breakout Box (BOB) to in-line C1939M using Traction Battery Low Voltage Service Cord; do not connect Traction Battery Low Voltage Service Cord to in-line C1939F.</li> <li>With key OFF, measure the resistance of the Y wire between BOB pin 54 and in-line 1969M.</li> <li><b>Is the resistance less than 5 ohms?</b></li> </ul>	Yes = GO to <b>9-35</b> .  No = REPAIR the Y wire.
<b>9-35 CHECK CIRCUIT 3404 (Y) (INSIDE OF TRACTION BATTERY SUPPORT TRAY) FOR OPEN</b> <ul style="list-style-type: none"> <li>Disconnect BOB from in-line C1939M, remove the traction battery, and connect Traction Battery High-Voltage Lockout and Diagnostic Tool to the traction battery high-voltage two-pin C3994M.</li> </ul> <p><b>⚠ WARNING: The traction battery contains high-voltage components and wiring. High-voltage insulated safety gloves and face shield must be worn when carrying out the following steps. Failure to follow this warning may result in severe personal injury or death.</b></p> <ul style="list-style-type: none"> <li>Connect BOB to traction battery support tray in-line C1939F using Traction Battery Low Voltage Service Cord; do not connect Traction Battery Low Voltage Service Cord to in-line C1939M.</li> <li>With key OFF, disconnect BCM C1987.</li> <li>Measure the resistance of the Y wire between pin 12 on BCM C1987 and BOB pin 54.</li> <li><b>Is the resistance less than 5 ohms?</b></li> </ul>	Yes = REPLACE the BCM. REFER to <a href="#">Section 414-03B</a> .  No = REPAIR the Y wire.

**ROUTINE 10: VEHICLE CHARGING TAKES LONGER THAN NORMAL TO REACH FULL STATE OF CHARGE (SOC) (LEAD ACID VEHICLES)**

TEST STEP	ACTION TO TAKE
<b>10-1 CHECK STATUS OF BATTERY CONTROL MODULE (BCM) OPERATING STATE</b> <p><b>NOTE:</b> Following charging, wait approximately five minutes to allow the BCM__OP PID to be set.</p> <ul style="list-style-type: none"> <li>Connect the vehicle to a power control station (PCS) and press the START button to begin charging.</li> <li><b>Does the BCM__OP PID indicate a limited cycle PID (State of charge-high battery temperature)?</b></li> </ul>	Yes = GO to <b>10-2</b> .  No = INFORM customer the vehicle may take longer to charge due to high environmental temperature conditions.
<b>10-2 CHECK TRACTION BATTERY TEMPERATURE SENSORS FOR OVERTEMPERATURE CONDITION</b> <ul style="list-style-type: none"> <li>With key ON, monitor BCM PIDs TMPSEN1, TMPSEN2, TMPSEN3, and TMPSEN4.</li> </ul>	Yes = GO to <b>10-3</b> .  If all TMPSEN PIDs are between 50°C (122°F) and 60°C (140°F), PARK the vehicle in a cool environment to cool down below 50°C (122°F).

(Continued)

**DIAGNOSIS AND TESTING (Continued)****ROUTINE 10: VEHICLE CHARGING TAKES LONGER THAN NORMAL TO REACH FULL STATE OF CHARGE (SOC) (LEAD ACID VEHICLES)**

TEST STEP	ACTION TO TAKE
<ul style="list-style-type: none"> <li>Do any of the TMPSEN PIDs indicate between 50°C (122°F) and 60°C (140°F)?</li> </ul>	No = DISCONNECT and RECONNECT the 12-volt auxiliary battery negative cable and RECHECK the BCM__OP PID. If the BCM__OP PID still indicates 112, REPLACE the BCM. REFER to <a href="#">Section 414-03A</a> .
<b>10-3 CHECK TEMPERATURE DIFFERENCE BETWEEN BATTERY TEMPERATURE SENSORS</b> <ul style="list-style-type: none"> <li>With key ON, monitor battery control module (BCM) PIDs TMPSEN1, TMPSEN2, TMPSEN3, and TMPSEN4.</li> <li>Is there a temperature difference of greater than 25°C (45°F) between the temperature sensor that is between 50°C (122°F) and 60°C (140°F), and the other temperature sensors?</li> </ul>	Yes = GO to <b>10-4</b> .  No = PARK the vehicle in a cool environment to cool the vehicle below 65°C (149°F) for the temperature sensor in question.
<b>10-4 CHECK BATTERY TEMPERATURE SENSOR</b> <ul style="list-style-type: none"> <li>Remove the traction battery and connect Traction Battery High-Voltage Lockout and Diagnostic Tool to the traction battery high-voltage two-pin C3994M.</li> <li>Connect Traction Battery High Voltage Service Cord to traction battery support tray in-line C1935F and in-line C1935M.</li> </ul> <p> <b>WARNING: The traction battery contains high-voltage components and wiring. High-voltage insulated safety gloves and face shield must be worn when carrying out the following steps. Failure to follow this warning may result in severe personal injury or death.</b></p> <ul style="list-style-type: none"> <li>Connect Traction Battery Low Voltage Service Cord to traction battery support tray in-line C1939F and in-line C1939M.</li> <li>With key OFF, disconnect the battery temperature sensor in question and one of the other temperature sensors.</li> <li>Connect jumper wires between the connector for the temperature sensor in question and the known good temperature sensor that was disconnected.</li> <li>With key ON, monitor battery control module (BCM) PIDs TMPSEN1, TMPSEN2, TMPSEN3, and TMPSEN4.</li> <li>Does the TMPSEN PID that indicated between 50°C (122°F) and 60°C (140°F) still indicate between 50°C (122°F) and 60°C (140°F)?</li> </ul>	Yes = REPLACE the BCM. REFER to <a href="#">Section 414-03A</a> .  No = REPLACE the battery temperature sensor in question.

**ROUTINE 11: VEHICLE CHARGING TAKES LONGER THAN NORMAL TO REACH FULL STATE OF CHARGE (SOC) (NIMH VEHICLES)**

TEST STEP	ACTION TO TAKE
<b>11-1 CHECK STATUS OF BATTERY CONTROL MODULE (BCM) OPERATING STATE</b> <p><b>NOTE:</b> Following charging, wait approximately five minutes to allow the BCM__OP PID to be set.</p> <ul style="list-style-type: none"> <li>Connect the vehicle to a power control station (PCS) and press the START button to begin charging.</li> </ul>	Yes = GO to <b>11-2</b> .

(Continued)

**DIAGNOSIS AND TESTING (Continued)****ROUTINE 11: VEHICLE CHARGING TAKES LONGER THAN NORMAL TO REACH FULL STATE OF CHARGE (SOC) (NIMH VEHICLES)**

TEST STEP	ACTION TO TAKE
<ul style="list-style-type: none"> <li>Does the BCM__OP PID indicate 118 (limited cycle PID category charge-battery under temperature)?</li> </ul>	No = INFORM customer the vehicle may take longer to charge due to low environmental temperature conditions.
<b>11-2 CHECK TRACTION BATTERY TEMPERATURE SENSORS FOR OVERTEMPERATURE CONDITION</b> <ul style="list-style-type: none"> <li>With key ON, monitor BCM PIDs TMPSEN1, TMPSEN2, and TMPSEN3.</li> </ul> <ul style="list-style-type: none"> <li>Do any of the TMPSEN PIDs indicate below -15°C (5°F)?</li> </ul>	Yes = GO to <b>11-3</b> .  If any of the TMPSEN PIDs are below -15°C (5°F), PARK the vehicle in a warm environment to warm up above -15°C (5°F).  No = DISCONNECT and RECONNECT the 12-volt auxiliary battery negative cable and RECHECK the BCM__OP PID. If the BCM__OP PID still indicates 118, REPLACE the BCM. REFER to <a href="#">Section 414-03B</a> .
<b>11-3 CHECK TEMPERATURE DIFFERENCE BETWEEN BATTERY TEMPERATURE SENSORS</b> <ul style="list-style-type: none"> <li>With key ON, monitor battery control module (BCM) PIDs TMPSEN1, TMPSEN2, and TMPSEN3.</li> <li>Is there a temperature difference of greater than 20°C (36°F) between the temperature sensor that is below -15°C (5°F), and the other temperature sensors?</li> </ul>	Yes = GO to <b>11-4</b> .  No = PARK the vehicle in a warm environment to warm the vehicle above -15°C (5°F) for the temperature sensor in question.
<b>11-4 CHECK BATTERY TEMPERATURE SENSOR</b> <ul style="list-style-type: none"> <li>Remove the traction battery and connect Traction Battery High-Voltage Lockout and Diagnostic Tool to the traction battery high-voltage two-pin C3994M.</li> <li>Connect Traction Battery High Voltage Service Cord to traction battery support tray in-line C1935F and in-line C1935M.</li> </ul> <p><b>⚠ WARNING: The traction battery contains high-voltage components and wiring. High-voltage insulated safety gloves and face shield must be worn when carrying out the following steps. Failure to follow this warning may result in severe personal injury or death.</b></p> <ul style="list-style-type: none"> <li>Connect Traction Battery Low Voltage Service Cord to traction battery support tray in-line C1939F and in-line C1939M.</li> <li>With key OFF, disconnect the battery temperature sensor in question and one of the other temperature sensors.</li> <li>Connect jumper wires between the connector for the temperature sensor in question and the known good temperature sensor that was disconnected.</li> <li>With key ON, monitor battery control module (BCM) PIDs TMPSEN1, TMPSEN2, and TMPSEN3.</li> <li>Does the TMPSEN PID that indicated below -15°C (5°F) and still indicate below -15°C (5°F)?</li> </ul>	Yes = REPLACE the BCM. REFER to <a href="#">Section 414-03B</a>  No = REPLACE the battery temperature sensor in question.

**DIAGNOSIS AND TESTING (Continued)****ROUTINE 12: COOLANT PUMP AND DC/DC CONVERTER OPERATE WHEN POWER CONTROL STATION (PCS) IS DISCONNECTED FROM THE CHARGER INLET CONNECTOR**

<b>TEST STEP</b>	<b>ACTION TO TAKE</b>
<b>12-1 CARRY OUT RESET</b>  <b>NOTE:</b> The coolant pump and DC/DC converter sometimes operate after disconnecting the power control station (PCS) from the charger inlet connector. This is normal operation. They will continue to operate for approximately 10 minutes if the ignition key is NOT cycled. <ul style="list-style-type: none"><li>• Cycle the ignition key ON/OFF.</li><li>• <b>Was the ignition key cycled ON/OFF?</b></li></ul>	Yes = System OK.  No = CYCLE the ignition key ON/OFF.

## GROUP

# Chassis **2**

SECTION TITLE	PAGE
Rear Suspension.....	204-02-1
Wheels and Tires .....	204-04-1
Rear Drive Halfshafts.....	205-05-1
Rear Disc Brake .....	206-04-1
Parking Brake and Actuation.....	206-05-1
Power Brake Actuation.....	206-07-1
Anti-Lock Control.....	206-09-1
Power Steering .....	211-02-1
Steering Column Switches.....	211-05-1

## SECTION 204-02 Rear Suspension

VEHICLE APPLICATION: Ranger EV

CONTENTS	PAGE
<b>SPECIFICATIONS</b> .....	204-02-2
<b>DESCRIPTION AND OPERATION</b>	
Rear Suspension.....	204-02-2
<b>REMOVAL AND INSTALLATION</b>	
Hub.....	204-02-3
Rear Axle .....	204-02-3
Rear Shock Absorber .....	204-02-14
Spring .....	204-02-16
Wheel Bearing.....	204-02-24

## SPECIFICATIONS

### Torque Specifications

Description	Nm	Lb-Ft	Lb-In
Backing Plate Bolts	15	11	—
Brake Line Bracket to Axle Bolt	12	—	107
Caliper Adapter Bolts	55	40.5	—
Caliper Bolts	25	18.5	—
Hub Nut	252	186	—
Lower Shock Absorber Nut	62.5	46	—

(Continued)

### Torque Specifications

Description	Nm	Lb-Ft	Lb-In
Lug Nuts	115	85	—
Rear Spring Mounting Bolts	116	85	—
Spring Clamp Plate Bolts	103	43	—
Upper Shock Absorber Nut	55	40.5	—

## DESCRIPTION AND OPERATION

### Rear Suspension

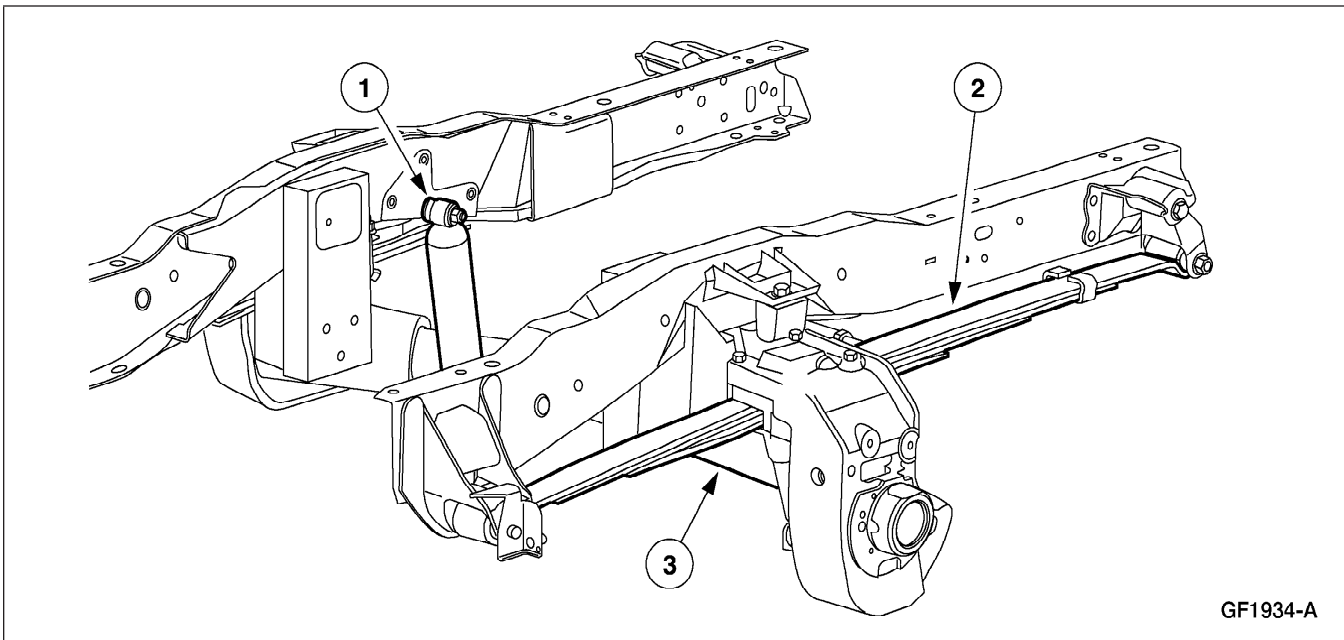

GF1934-A

Item	Part Number	Description
1	—	Shock Absorber
2	—	Spring
3	—	Rear Axle



## DESCRIPTION AND OPERATION (Continued)

The rear suspension of the Electric Ranger consists of special components designed for use with the vehicle's unique electric motor/transaxle. The axle consists of thick walled aluminum tubing and cast aluminum knuckles. Tabs and brackets are welded to the axle in various points to attach the watts linkage, shock absorbers, and brake lines. The knuckles are machined to accept the brake backing plates and the hubs. The hubs are supported by pressed-on bearings and connect to the splined halfshaft ends.

## REMOVAL AND INSTALLATION

### Hub

#### Special Tool(s)

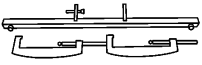
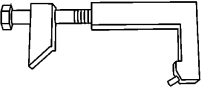
 <p>ST2343-A</p>	<p>Spring Flattening Tools 204-F002</p>
 <p>ST2344-A</p>	<p>Cap Aligner 204-F003</p>

1. **NOTE:** The wheel bearing must be replaced each time the hub is removed. The wheel bearing removal and installation procedure contains all of the necessary steps for hub removal and installation.

Hub removal and installation is included in the Wheel Bearing Procedure. Refer to [Wheel Bearing](#).

### Rear Axle

#### Removal

1. Remove the RH spring. Refer to [Spring](#).

## REMOVAL AND INSTALLATION (Continued)

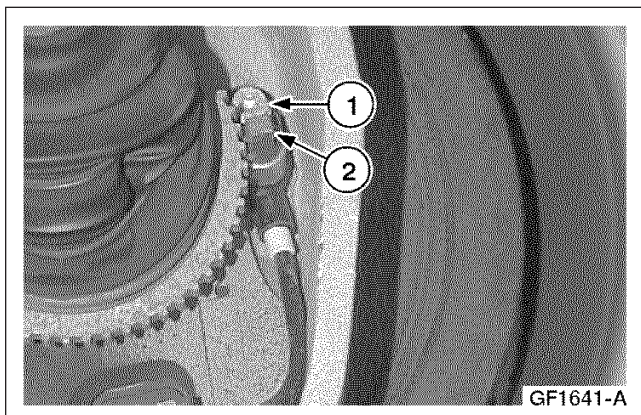
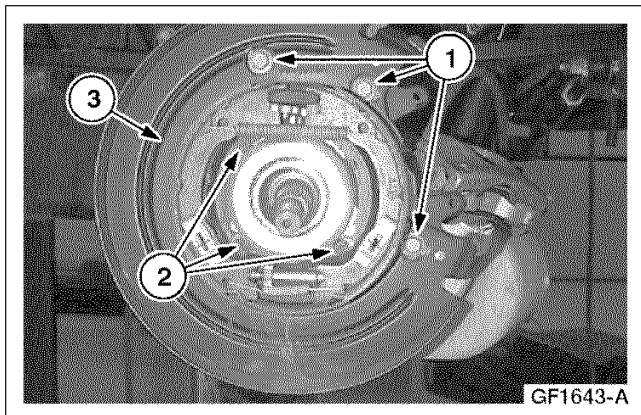
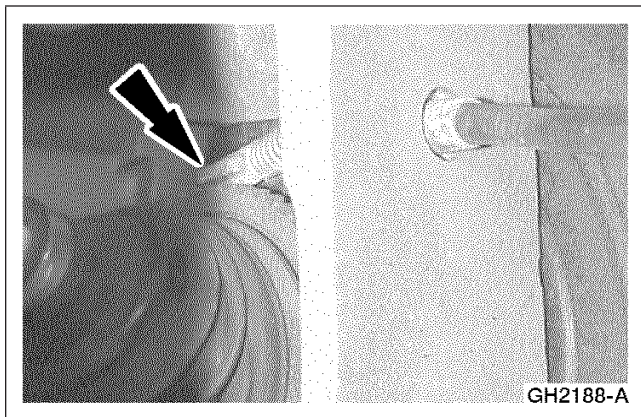
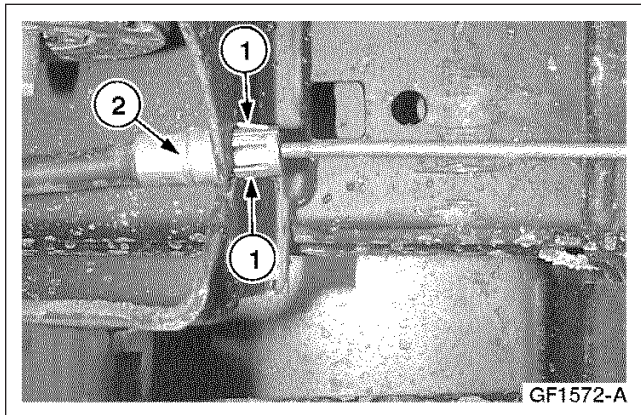

2. Remove the LH and RH hubs. Refer to [Hub](#).
3. Release tension on the parking brake cable.
  - 1 Depress the cable bracket tabs.
  - 2 Pull the cable toward the front of the vehicle and slide the cable out of the bracket.
4. **NOTE:** LH shown, RH similar.  
Disconnect the LH and RH parking brake cables.
5. **NOTE:** LH shown, RH similar.  
**NOTE:** The caliper adapter is removed with the brake pads installed.  
Remove the LH and RH backing plates.
  - 1 Remove the three caliper adapter bolts.
  - 2 Remove the three backing plate bolts.
  - 3 Remove the caliper adapter/backing plate assembly.
6. Remove the LH and RH ABS wheel speed sensors.
  - 1 Remove the bolt.
  - 2 Carefully remove the sensor.

## REMOVAL AND INSTALLATION (Continued)

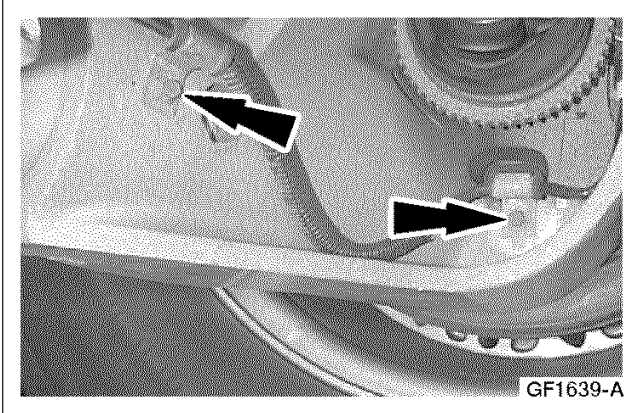

7. **NOTE:** LH shown, RH similar.  
Remove the two LH and RH harness clamp bolts.

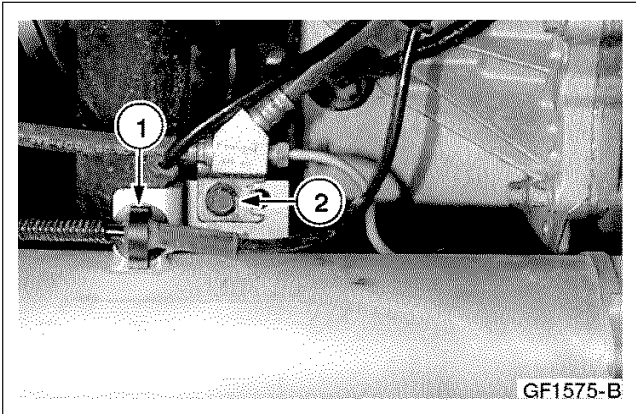

8. **NOTE:** LH shown, RH similar.  
Disconnect the brake lines from the axle.
- 1 Unclip the ABS wire from the axle.
  - 2 Remove the brake line bracket bolt.

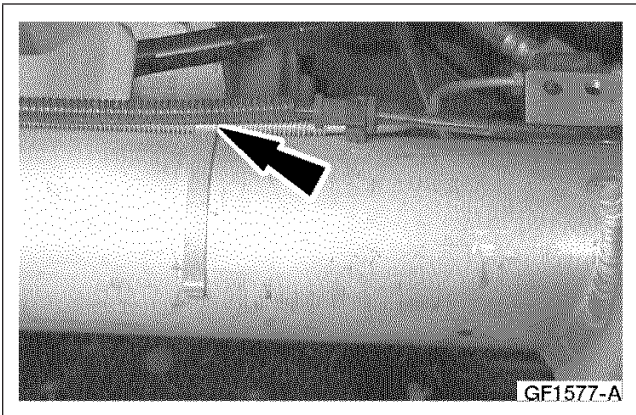

9. Unclip the brake line.

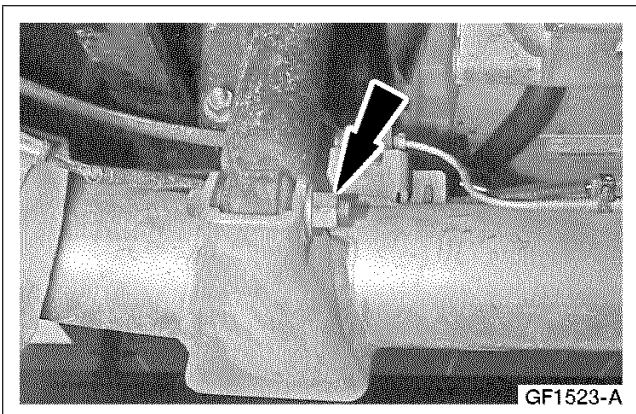

10. Remove the LH and RH lower shock mount bolts.

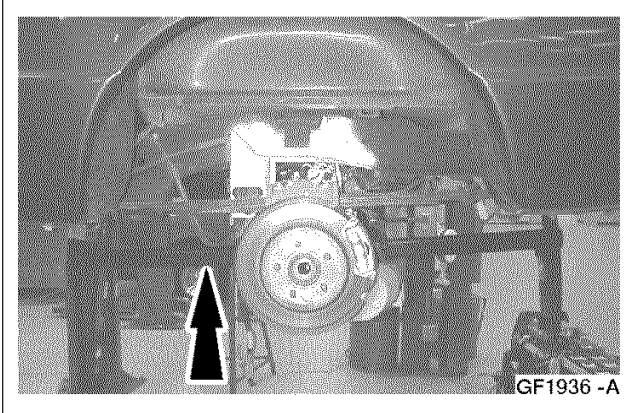
**REMOVAL AND INSTALLATION (Continued)**

11. Install the special tool to flatten the LH rear spring.

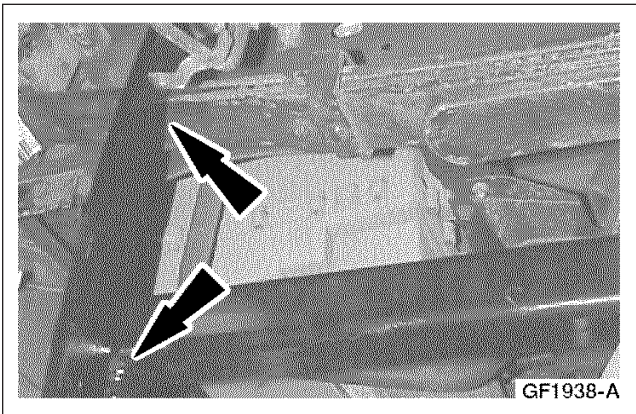

12. Position the front spring clamp.

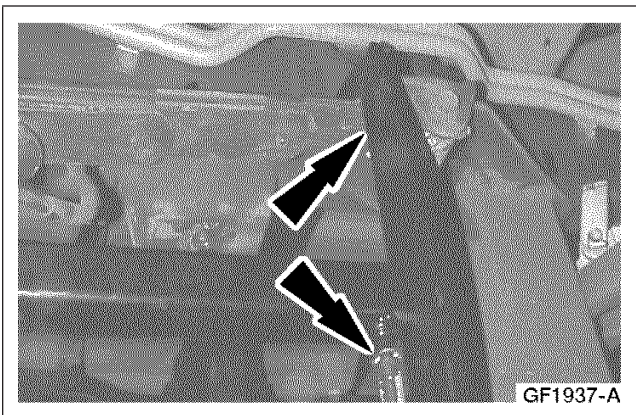

13. Position the rear spring clamp.

14. Tighten the spring clamps alternately until the spring is parallel to the bar of the special tool.

## REMOVAL AND INSTALLATION (Continued)

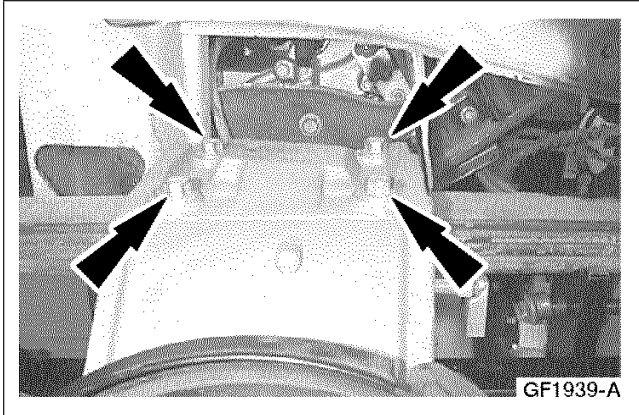

15. Remove the LH spring clamping plate.

16. Remove the rear axle.

### Installation

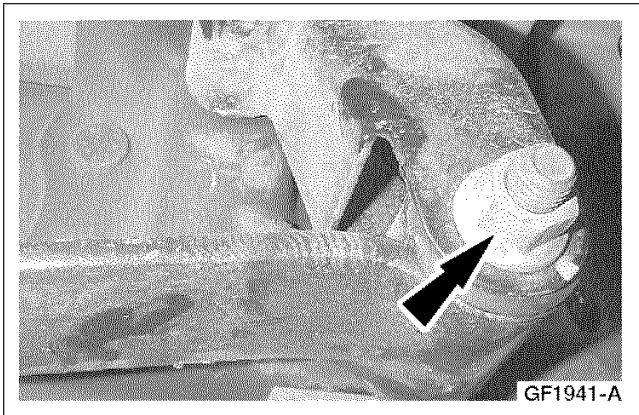

1. **⚠ CAUTION: Do not fully tighten the bolt until the vehicle has been lowered and the rear suspension is in the curb position.**

Position the spring and install the rear through bolt.

- Hand tighten the bolt.

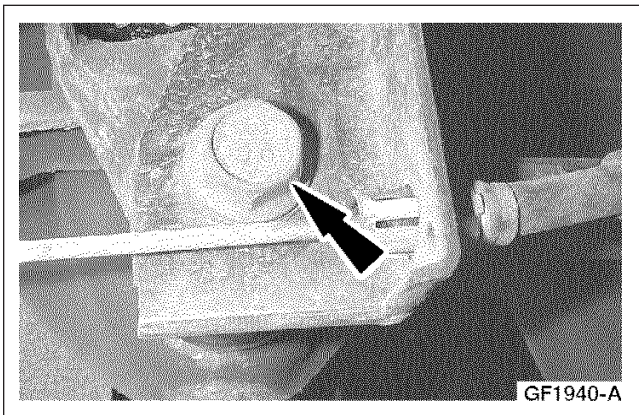

2. **NOTE: Do not fully tighten the bolt until the vehicle has been lowered and the rear suspension is in the curb position.**

Install the front through bolt.

- Hand tighten the bolt.

3. Position the upper spring insulator between the spring and the axle.

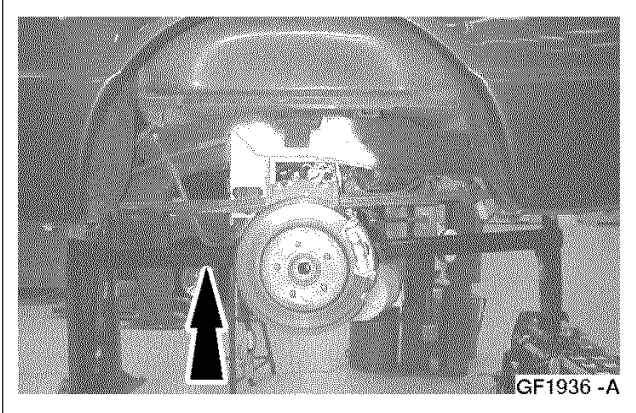
**REMOVAL AND INSTALLATION (Continued)**

4. Install the special tools to flatten both the rear springs.

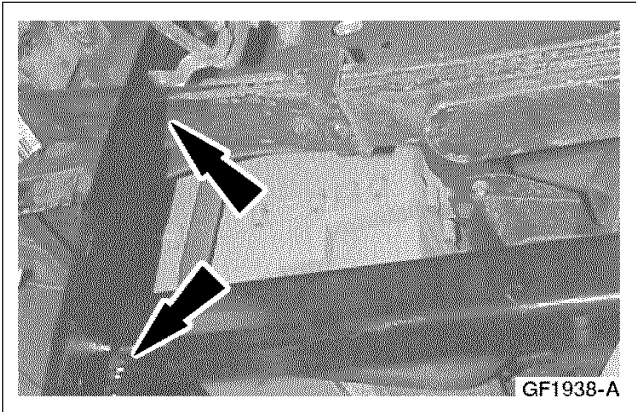

5. Position the front spring clamps.

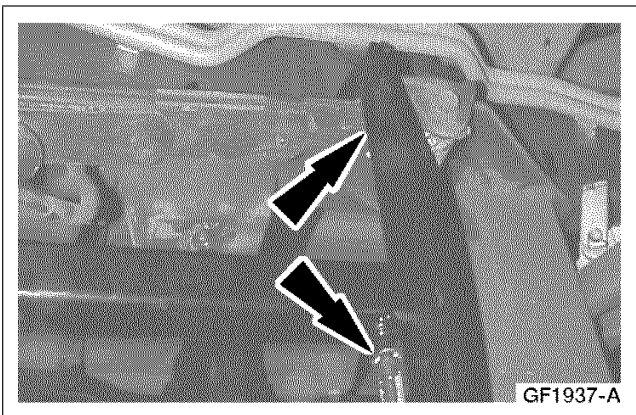

6. Position the rear spring clamps.

7. Tighten the spring clamps alternately until the spring is parallel to the bar of the special tool.

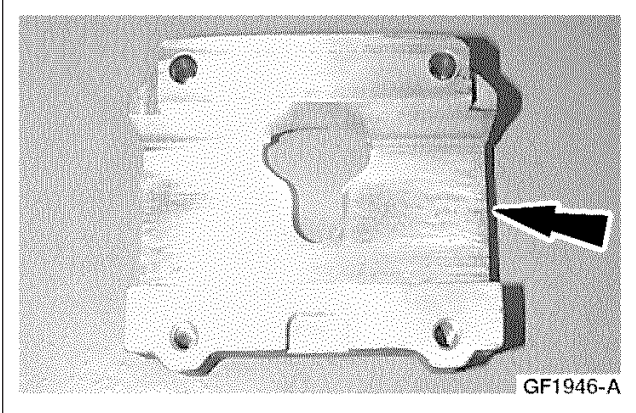
**REMOVAL AND INSTALLATION (Continued)**

8. Apply a soap and water solution to the inside of the spring clamp plate.

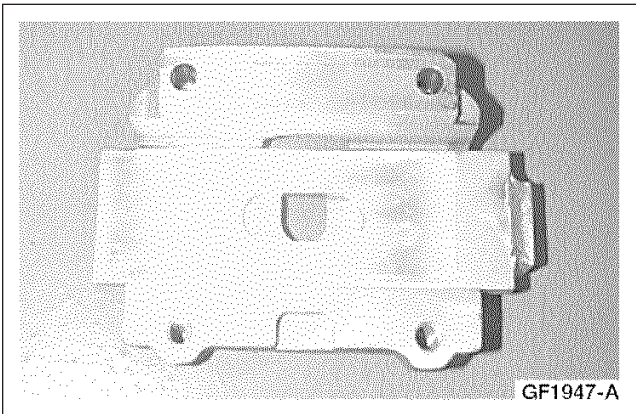

9. Position the rear leaf spring shim in the spring clamp plate.

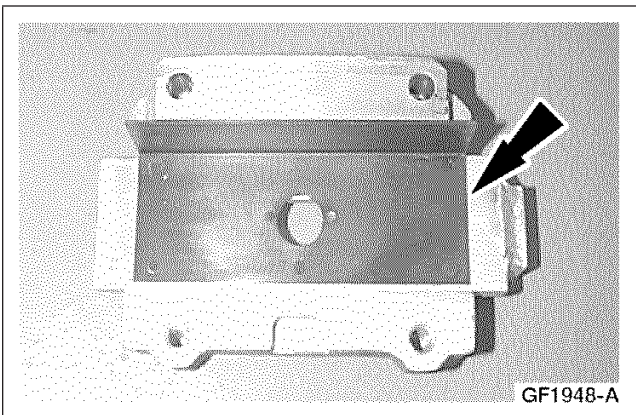

10. Position the insulator on top of the rear leaf spring shim.

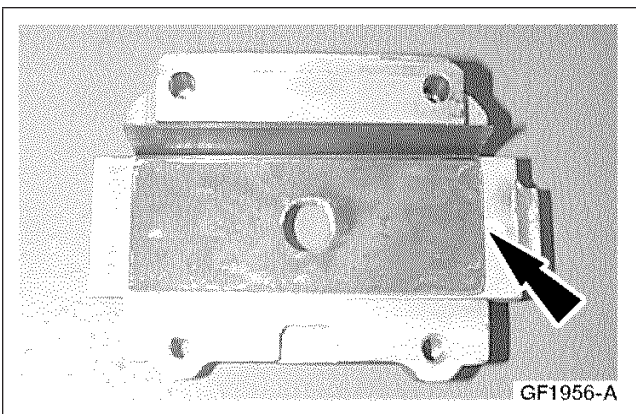

11. Position the spacer on top of the insulator.

## REMOVAL AND INSTALLATION (Continued)

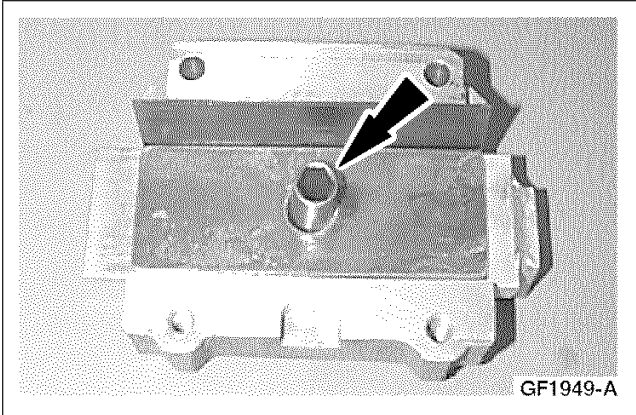

12. Place a 15 mm deep socket through the hole in the spring clamp plate assembly to align all of the components.

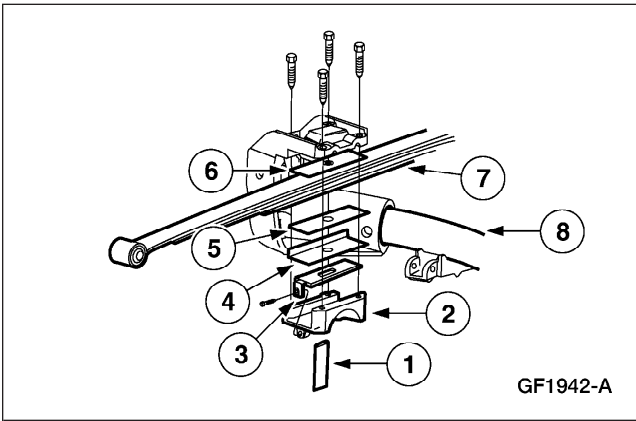

13. Install the spring clamp plate assembly as shown and loosely install the bolts.

- 1 15 mm socket
- 2 Spring clamp plate
- 3 Rear leaf spring shim
- 4 Lower insulator
- 5 Spacer
- 6 Upper insulator
- 7 Spring
- 8 Axle

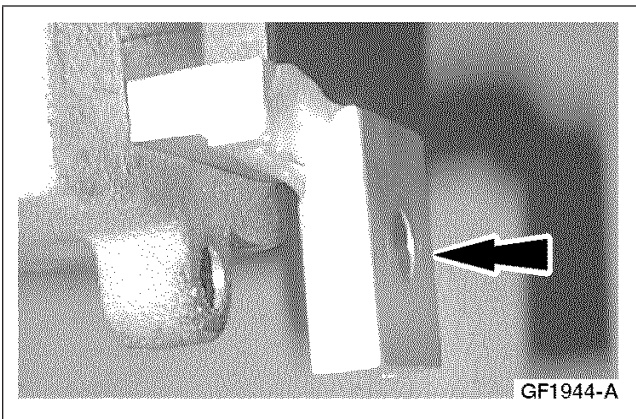

14. With the 15 mm socket still in place, pull the shim back as far as possible.

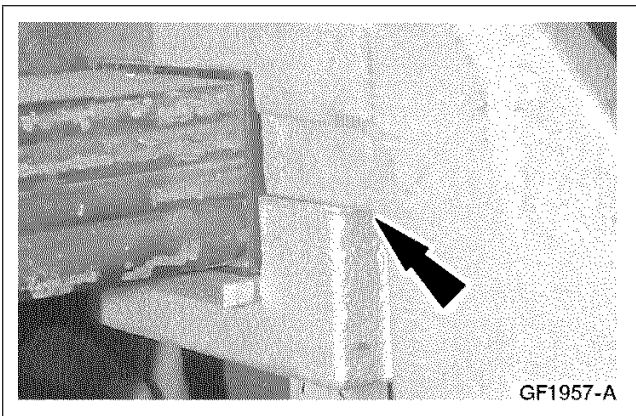

15. Verify that the spring clamp plate is contacting the hub assembly. If the two surfaces do not contact each other, replace the steel spacer with a thinner shim (four available).



## REMOVAL AND INSTALLATION (Continued)

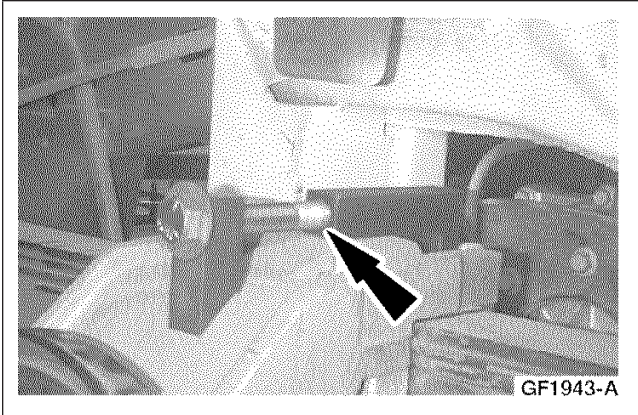

16. Using the special tool, align the spring clamp plate, spring, and hub assembly.
  - Tighten the bolt until the edges of the spring clamp plate and the hub assembly are parallel.

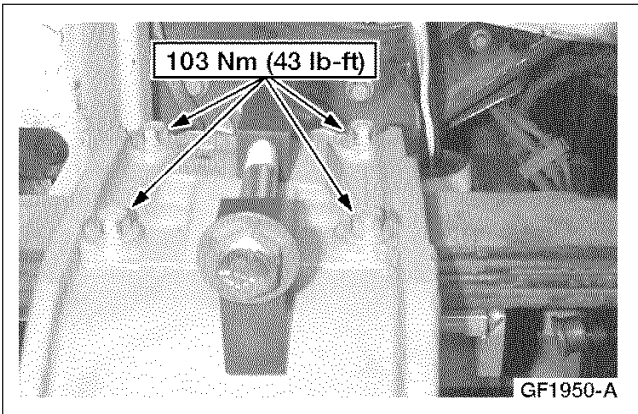

17. Tighten the bolts.

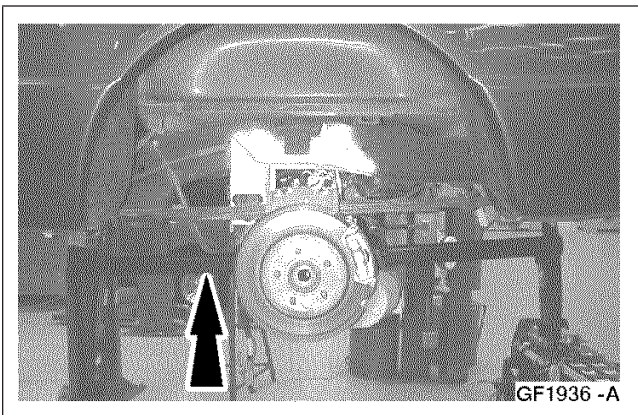

18. Remove the special tools.

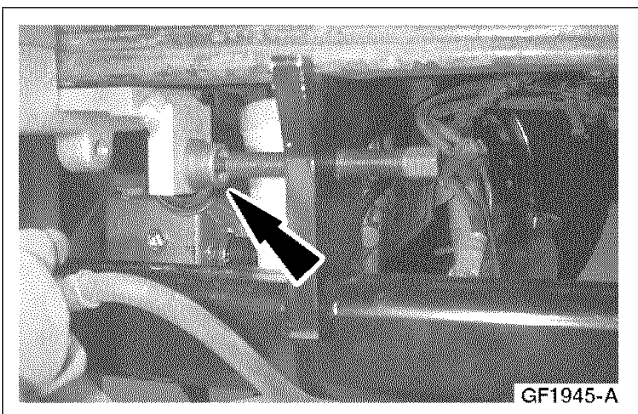

19. Using the special tool, install the rear leaf spring shim.
  - If the shim does not have enough travel to achieve the correct installation depth, remove the steel shim and install a thicker shim (four available).

## REMOVAL AND INSTALLATION (Continued)

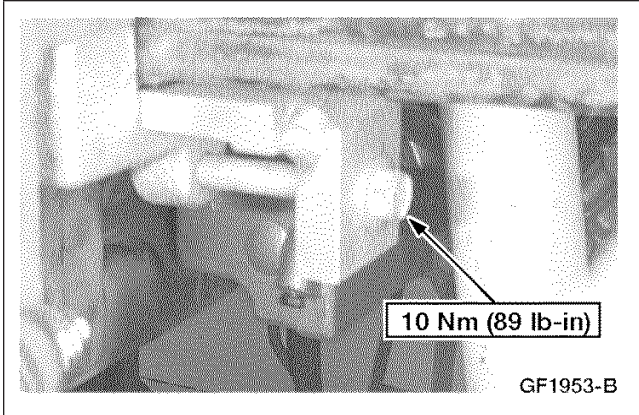

20. Install the rear leaf spring shim bolt.

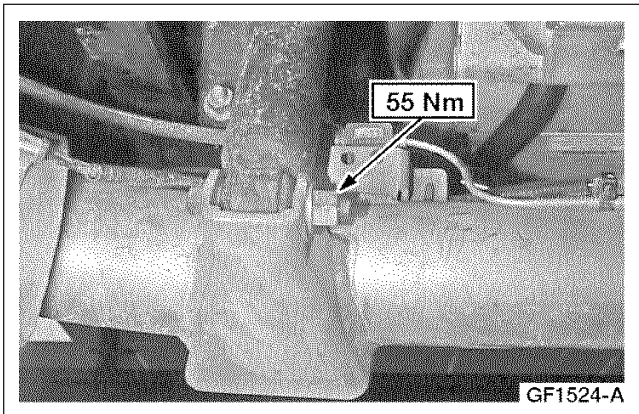

21. **NOTE:** LH shown, RH similar.

Install the LH and RH lower shock mount bolts.

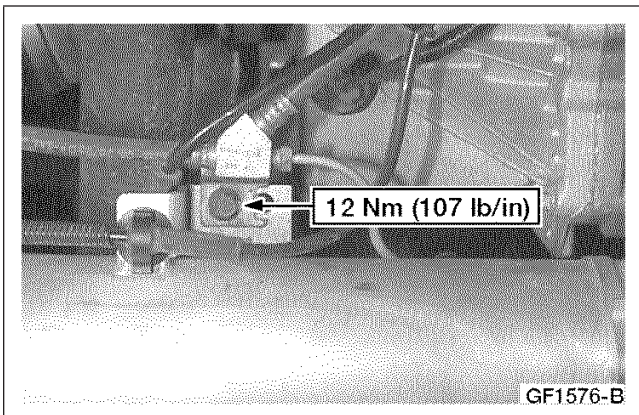

22. **NOTE:** LH shown, RH similar.

Install the brake line bracket bolt and clip the ABS wire onto the axle.

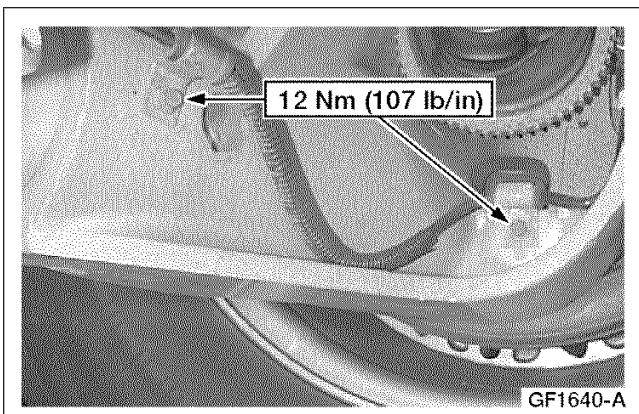

23. Install the two LH and RH harness clamp bolts.

## REMOVAL AND INSTALLATION (Continued)

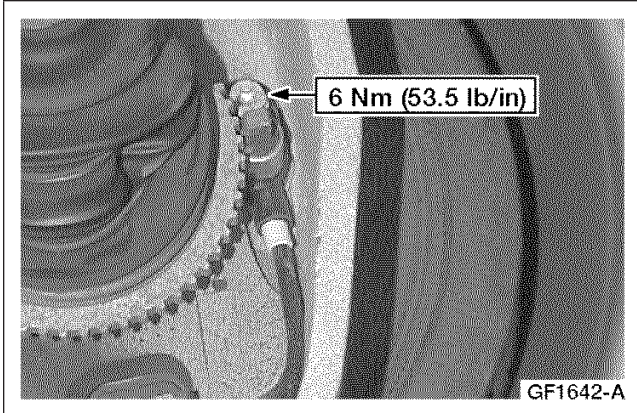

24. **NOTE:** LH shown, RH similar.

Position the LH and RH ABS wheel speed sensors and install the bolts.

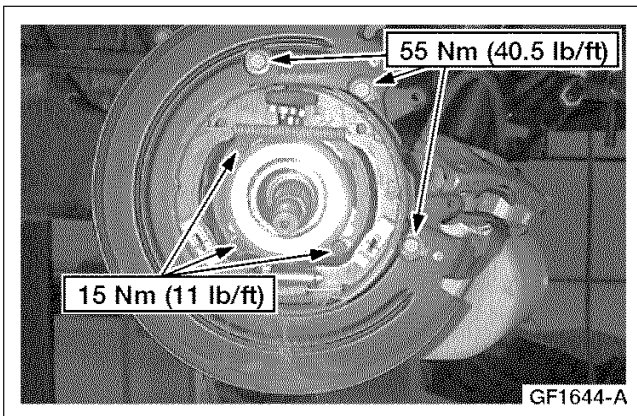

25. **NOTE:** LH shown, RH similar.

Position the LH and RH backing plates and install the bolts.

26. Lower the vehicle.

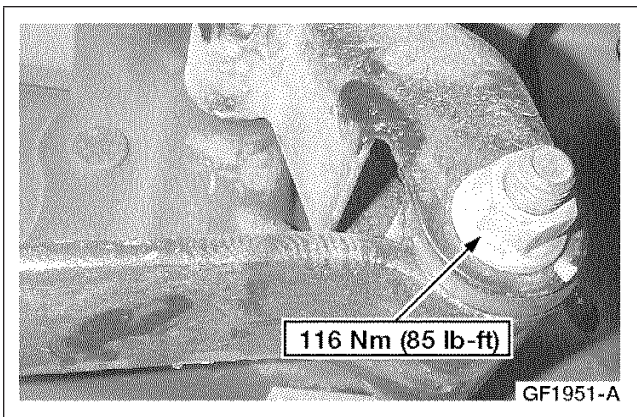

27. Tighten the spring through bolt.

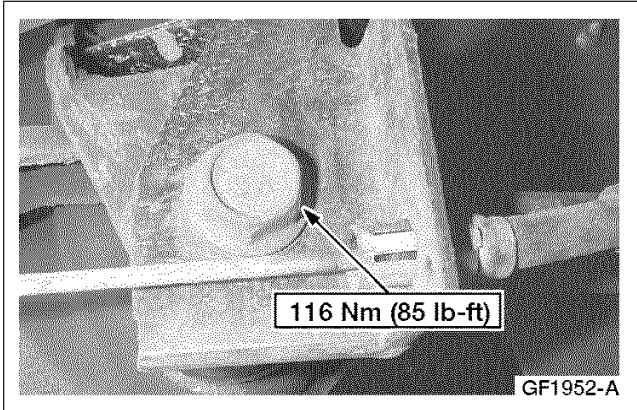

28. Tighten the spring through bolt.

**REMOVAL AND INSTALLATION (Continued)**

29. Install the LH and RH hubs. Refer to [Hub](#).
30. Install the RH spring. Refer to [Spring](#).

**Rear Shock Absorber****Removal**

1. Raise and support the vehicle. Refer to [Section 100-02](#).

2.  **CAUTION: Do not position the jack stand under the tube portion of the rear axle or vehicle damage may result.**

Support the axle.

- Position the jack stand under the cast end of the axle.

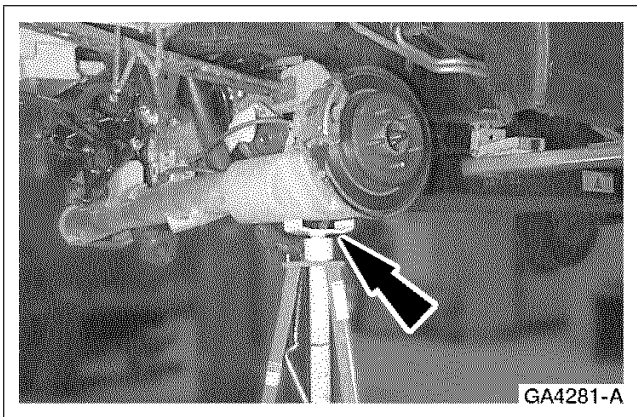

3. Lower the vehicle approximately two inches (5 cm) to remove tension on the shock absorber.
4. Remove the upper shock absorber nut.

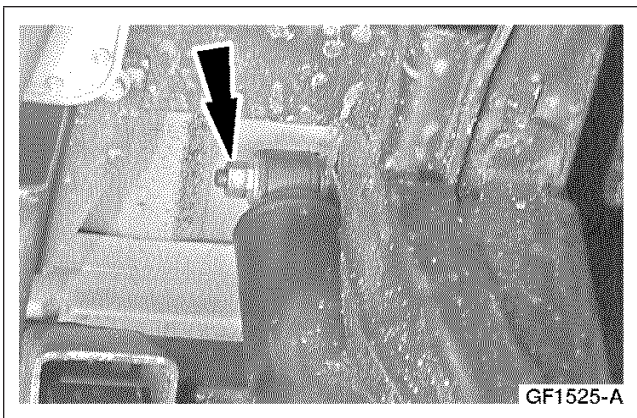

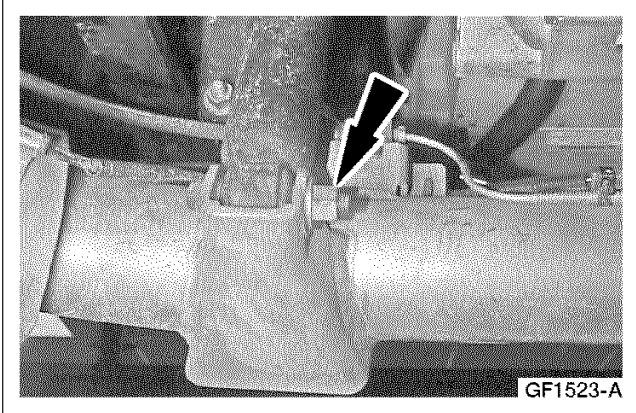
**REMOVAL AND INSTALLATION (Continued)**

5. Remove the shock absorber.
  - Remove the nut.

**Installation**

1. To install, reverse the removal procedure.

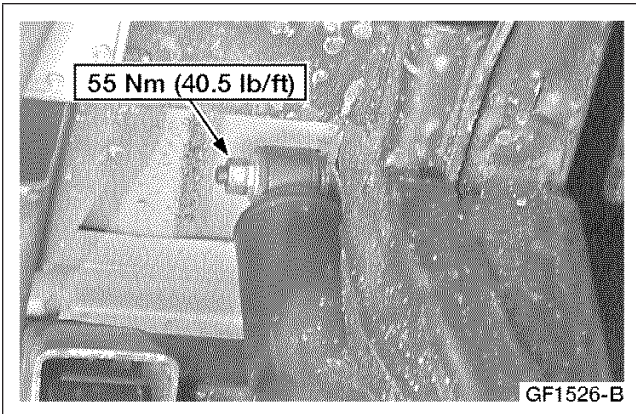
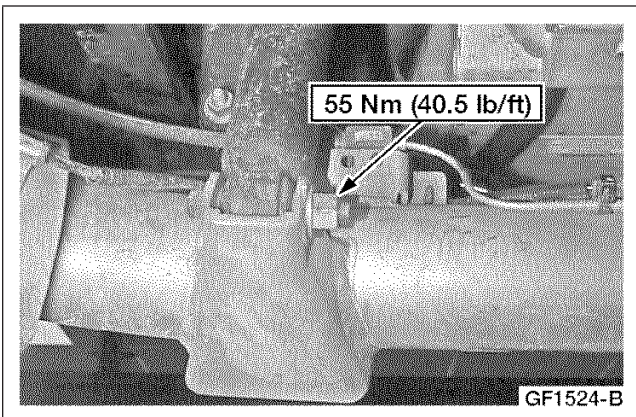

## REMOVAL AND INSTALLATION (Continued)

### Spring

#### Special Tool(s)

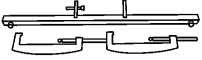
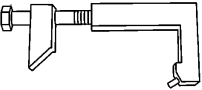
 <p>ST2343-A</p>	<p>Spring Flattening Tools 204-F002</p>
 <p>ST2344-A</p>	<p>Cap Aligner 204-F003</p>

#### Removal

**NOTE:** Both Spring Flattening Tools (204-F002) must be used to flatten the rear springs.

**NOTE:** The LH spring procedure is shown, the RH procedure is similar.

**NOTE:** The rear lifting points are changed for spring removal.

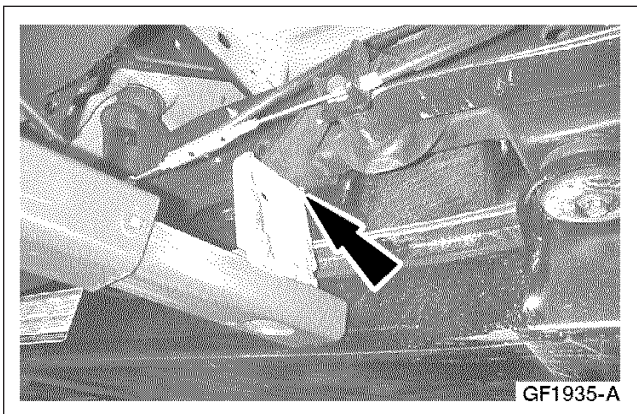

1. Position the hoist LH and RH rear lifting points as shown.

2. Remove the halfshaft. Refer to [Section 205-05](#).

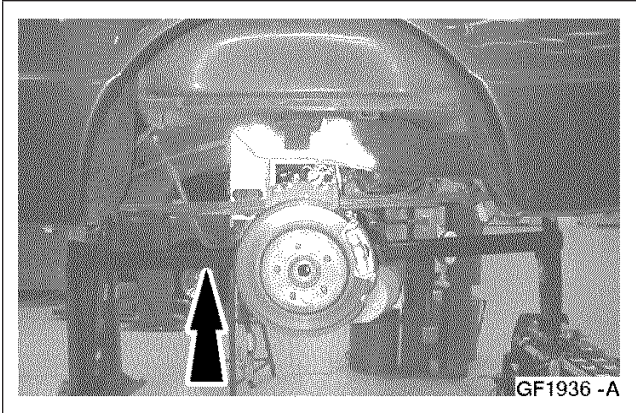
**REMOVAL AND INSTALLATION (Continued)**

3. Install the special tools to flatten both the rear springs.

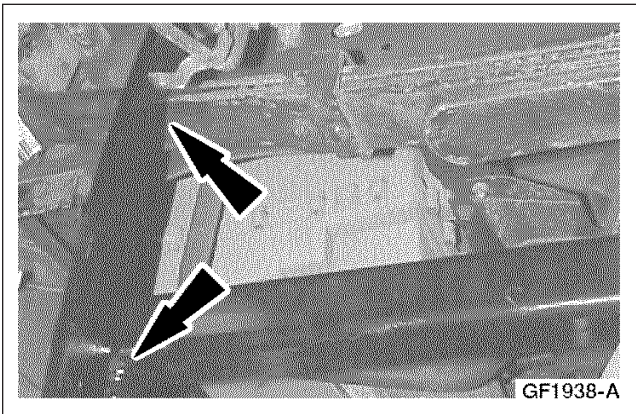

4. Position the front spring clamp.

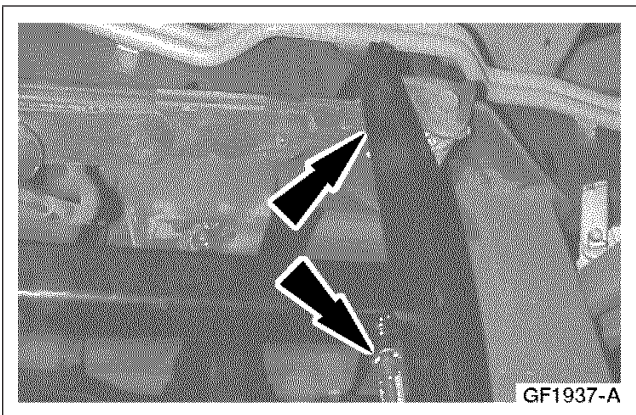

5. Position the rear spring clamp.

6. Tighten the spring clamps alternately until the spring is parallel to the bar of the special tool.

## REMOVAL AND INSTALLATION (Continued)

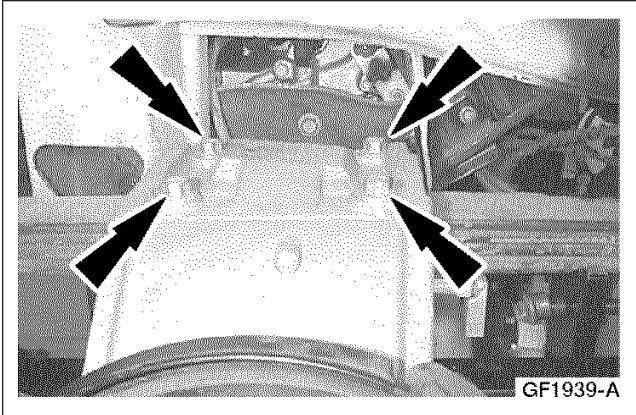

7. Remove the LH spring clamping plate.

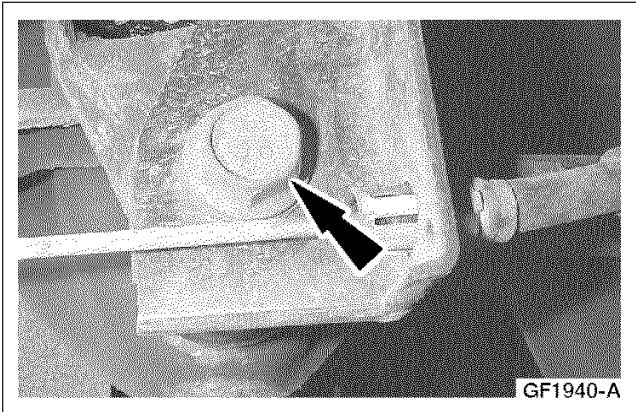

8. Remove the front spring mount through bolt.

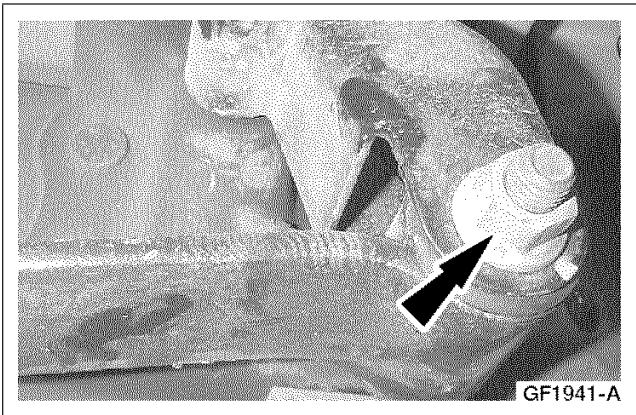

9. Remove the rear spring mount through bolt.

## Installation

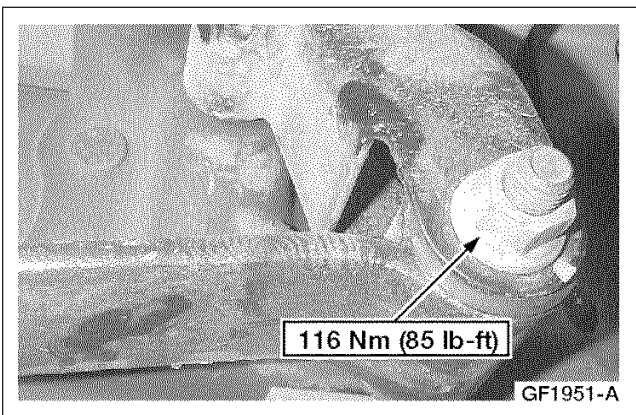

1. Position the spring and install the rear mount through bolt.

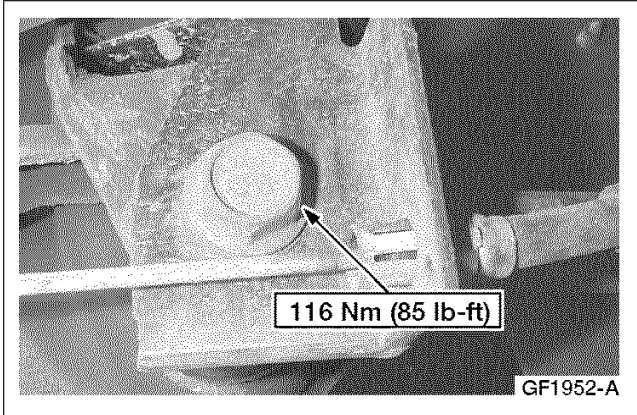

**REMOVAL AND INSTALLATION (Continued)**

2. Install the front spring mount through bolt.

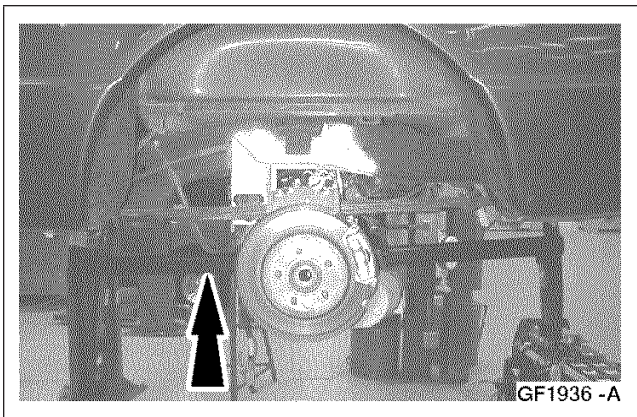

3. Position the upper spring insulator between the spring and the axle.
4. Install the special tools to flatten both the rear springs.

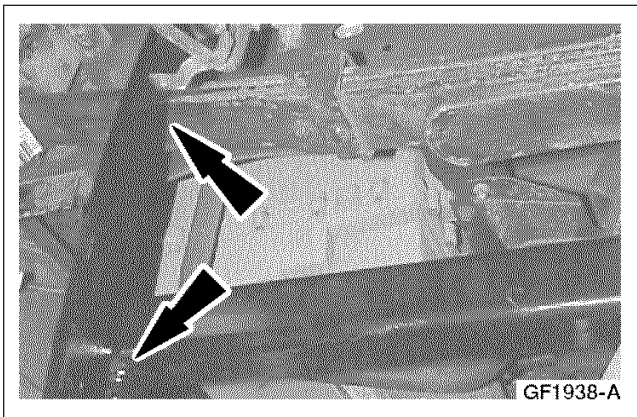

5. Position the front spring clamp.

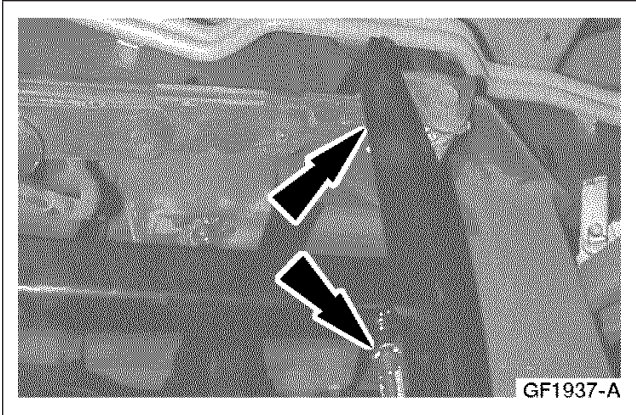
**REMOVAL AND INSTALLATION (Continued)**

6. Position the rear spring clamp.

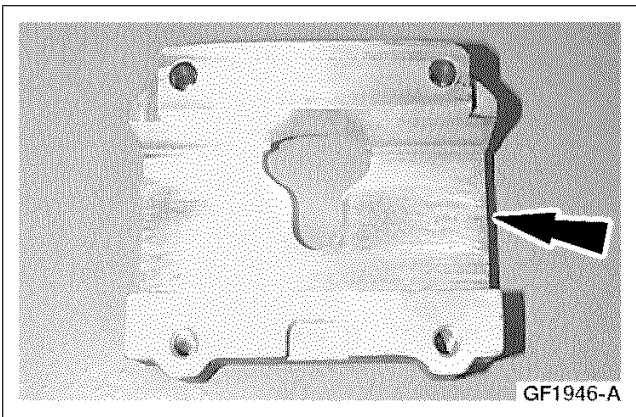

7. Tighten the spring clamps alternately until the spring is parallel to the bar of the special tool.
8. Apply a soap and water solution to the inside of the spring clamp plate.

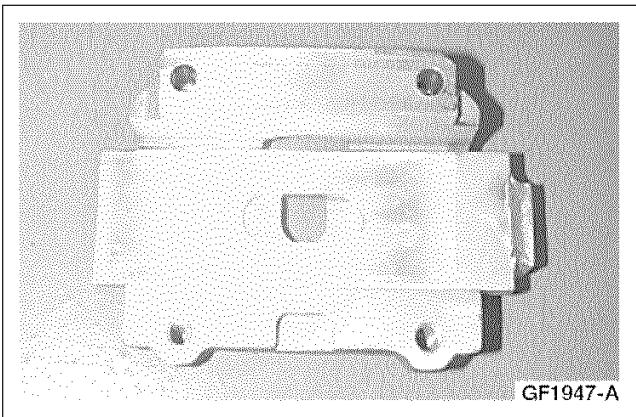

9. Position the rear leaf spring shim in the spring clamp plate.

## REMOVAL AND INSTALLATION (Continued)

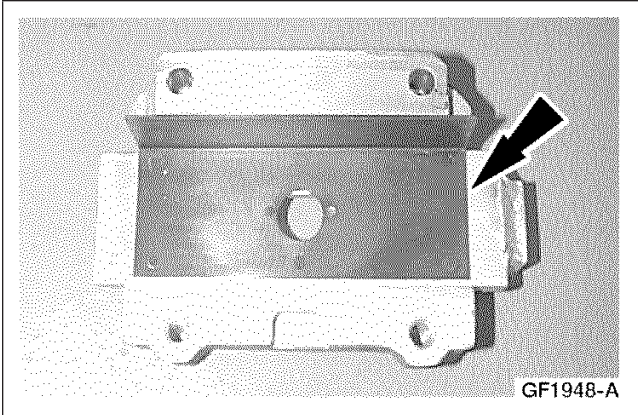

10. Position the insulator on top of the rear leaf spring shim.

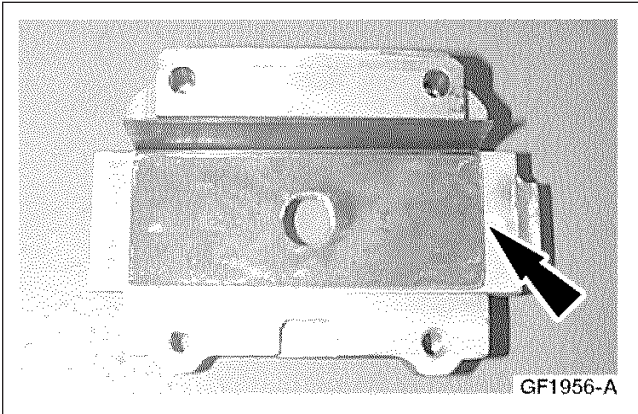

11. Position the spacer on top of the insulator.

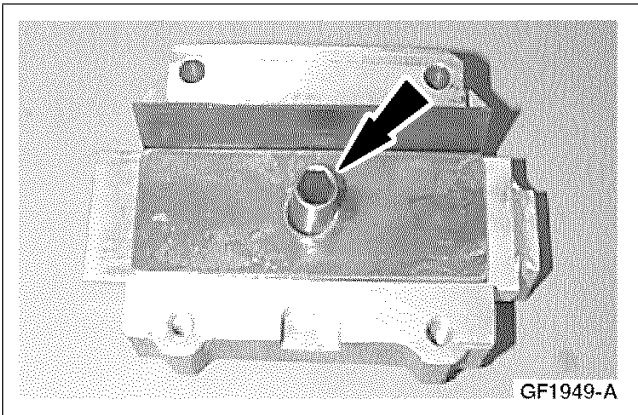

12. Place a 15 mm deep socket through the hole in the spring clamp plate assembly to align all of the components.

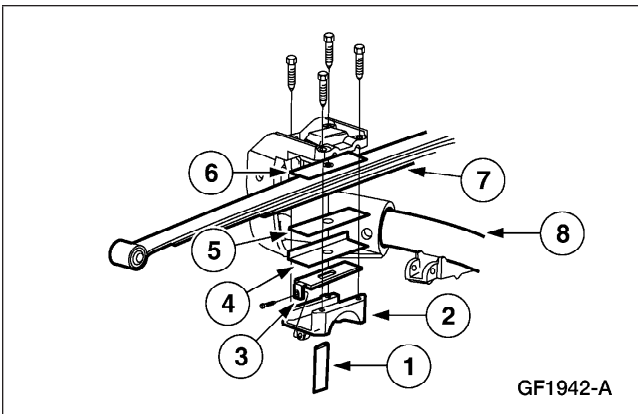

13. Install the spring clamp plate assembly as shown and loosely install the bolts.

- 1 15 mm socket
- 2 Spring clamp plate
- 3 Rear leaf spring shim
- 4 Lower insulator
- 5 Spacer
- 6 Upper insulator
- 7 Spring
- 8 Axle

## REMOVAL AND INSTALLATION (Continued)

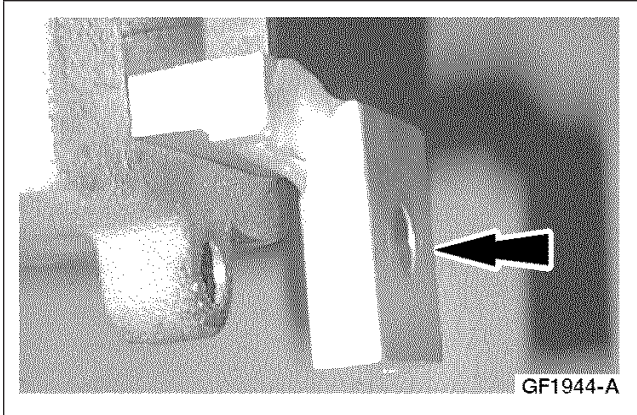

14. With the 15 mm socket still in place, pull the shim back as far as possible.

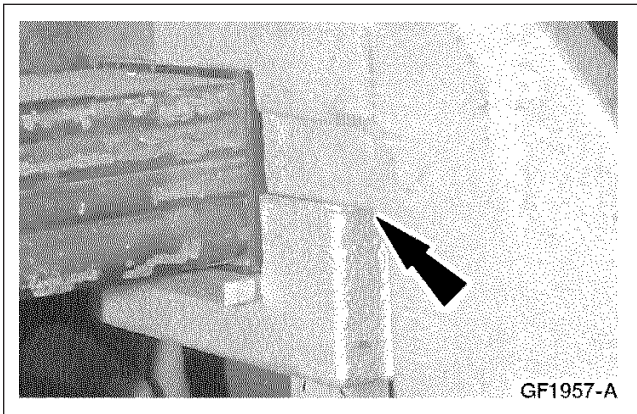

15. Verify that the spring clamp plate is contacting the hub assembly. If the two surfaces do not contact each other, replace the steel spacer with a thinner shim (four available).

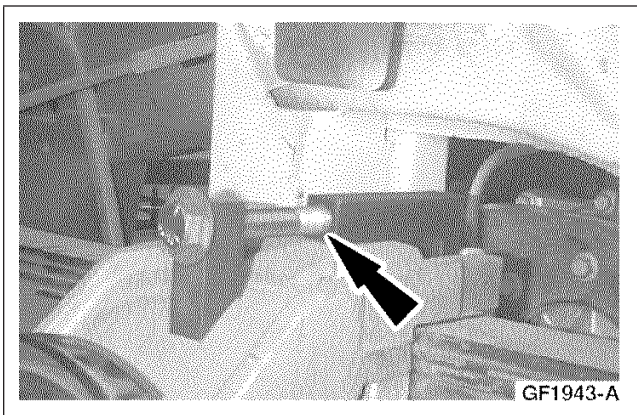

16. Using the special tool, align the spring clamp plate, spring, and hub assembly.
- Tighten the bolt until the edges of the spring clamp plate and the hub assembly are parallel.

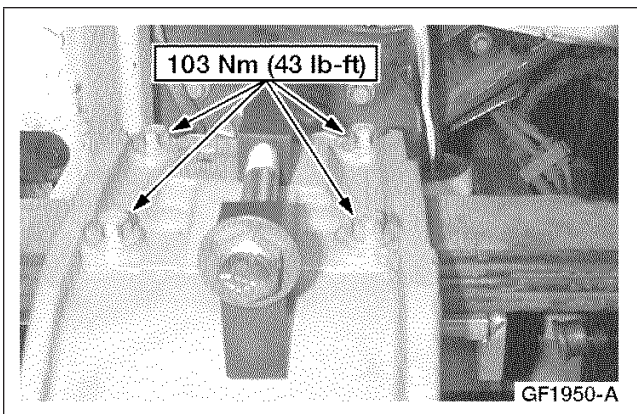

17. Tighten the bolts.

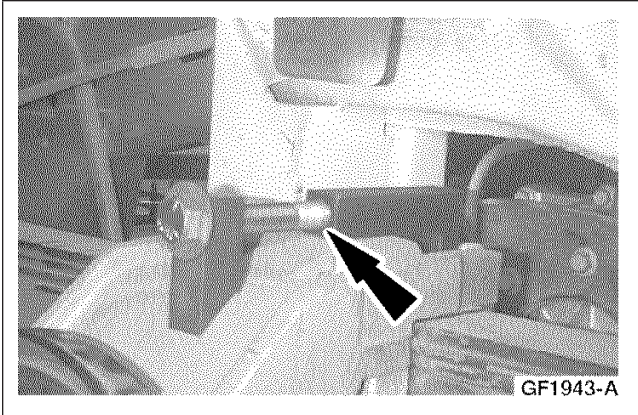
**REMOVAL AND INSTALLATION (Continued)**

18. Remove the special tool.

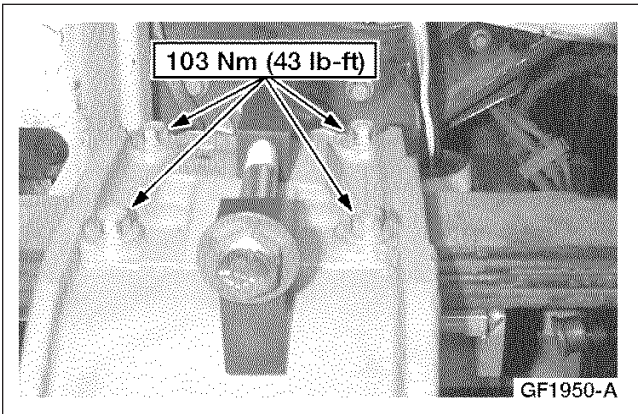

19. Using the special tool, install the rear leaf spring shim.

- If the shim does not have enough travel to achieve the correct installation depth, remove the steel shim and install a thicker shim (four available).

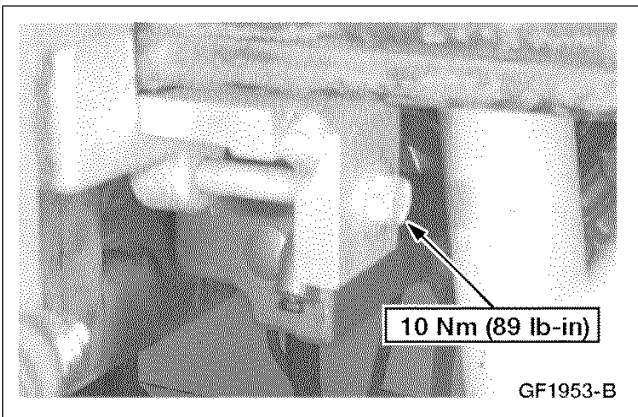

20. Install the rear leaf spring shim bolt.

21. Install the halfshafts. Refer to [Section 205-05](#).

## REMOVAL AND INSTALLATION (Continued)

### Wheel Bearing

#### Special Tool(s)

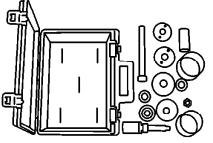
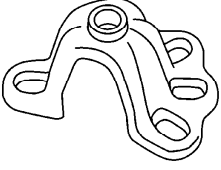
 <p style="text-align: center;"><b>ST2087-A</b></p>	<p>Wheel Bearing Removal and Installation Kit or equivalent OTC-7686</p>
 <p style="text-align: center;"><b>ST2081-A</b></p>	<p>Hub Puller D93P-1175-B</p>

(Continued)

#### Special Tool(s)

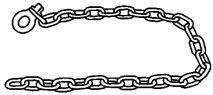
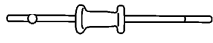
 <p style="text-align: center;"><b>ST2082-A</b></p>	<p>Safety Chain —</p>
 <p style="text-align: center;"><b>ST2083-A</b></p>	<p>Slide Hammer 100-D006 (D79P-100-A)</p>

#### Removal

1. Remove the halfshaft. Refer to [Section 205-05](#).
2. Position the caliper.
  - 1 Remove the bolts.
  - 2 Position the caliper and support it so there is no weight on the brake hose.
3. Remove the rotor.
  - 1 Remove the retaining clips.
  - 2 Remove the rotor.

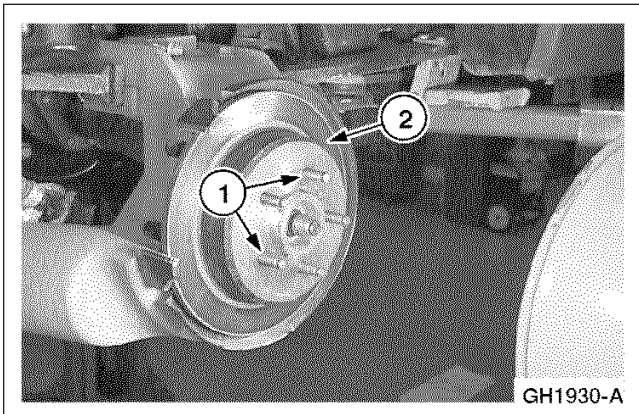
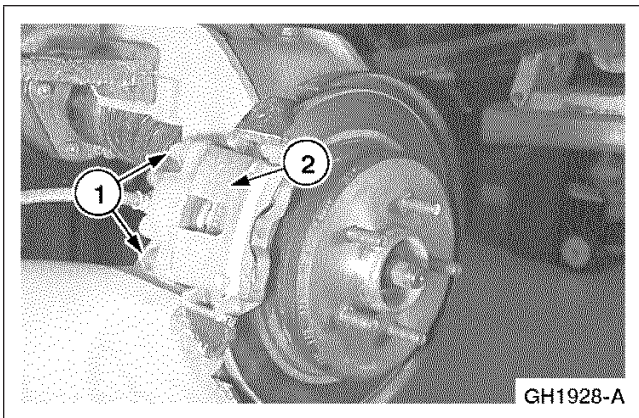

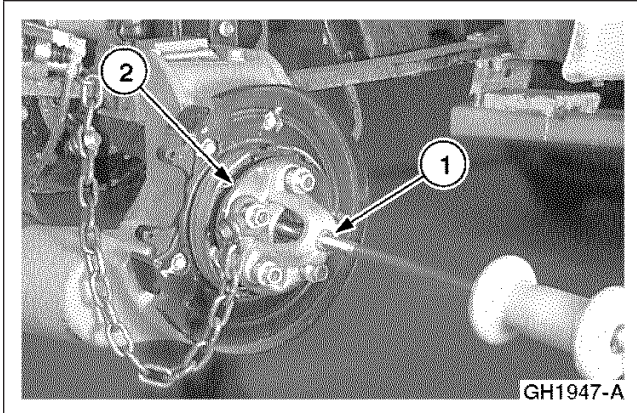
**REMOVAL AND INSTALLATION (Continued)**

4. Remove the hub.
  - 1 Install Hub Puller, Safety Chain, and Slide Hammer.
  - 2 Remove the hub.

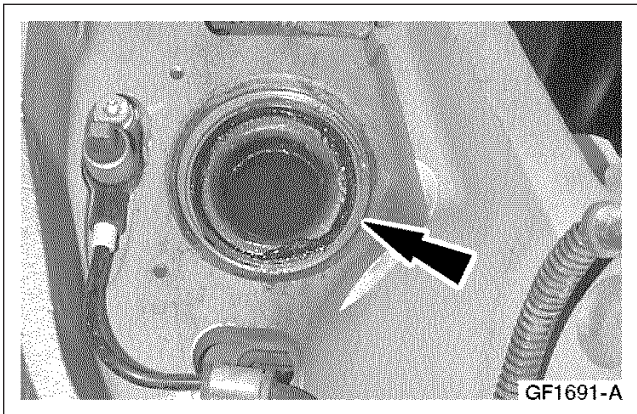

5. Remove snap ring.

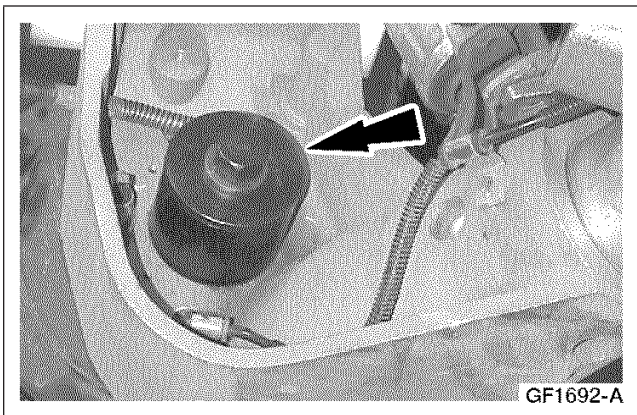

6. Remove the wheel bearing using the Wheel Bearing Removal and Installation Kit or equivalent.

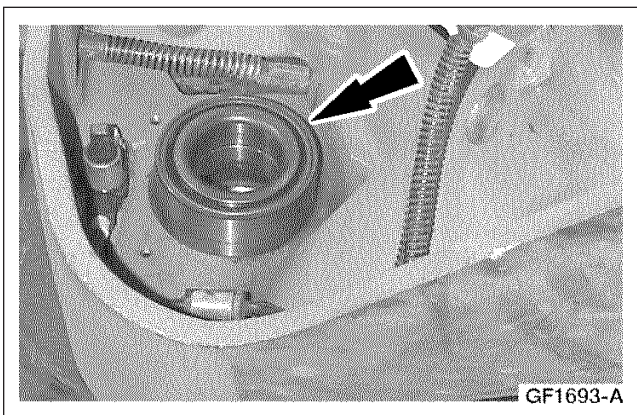
**Installation**

1. Position the wheel bearing.

## REMOVAL AND INSTALLATION (Continued)

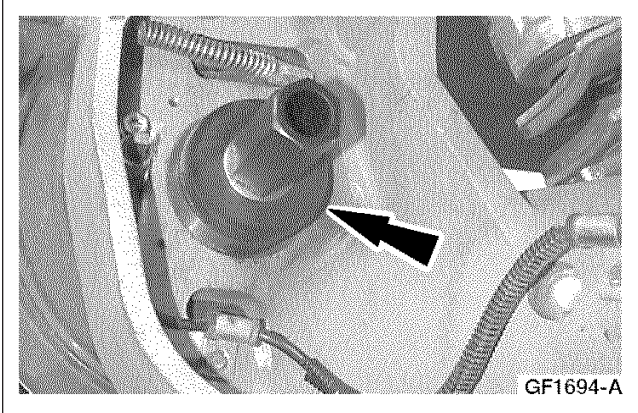

2. Install the wheel bearing using the Wheel Bearing Removal and Installation Kit or equivalent.

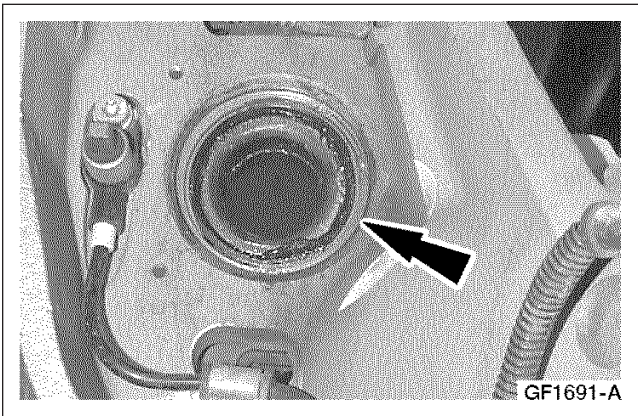

3. Install the snap ring.

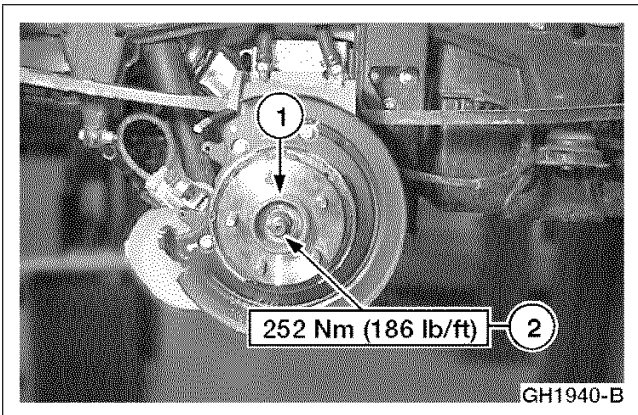

4. Install the halfshaft. Refer to [Section 205-05](#).
5. Install the hub.
  - 1 Position the hub.
  - 2 Install the hub washer and nut. Tighten the nut to the specified torque to install the hub into the bearing and over the halfshaft.

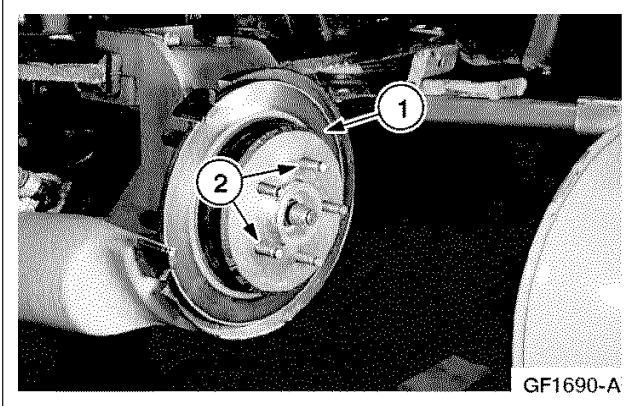

6. Install the rotor.
  - 1 Position the rotor.
  - 2 Install the retaining clips.

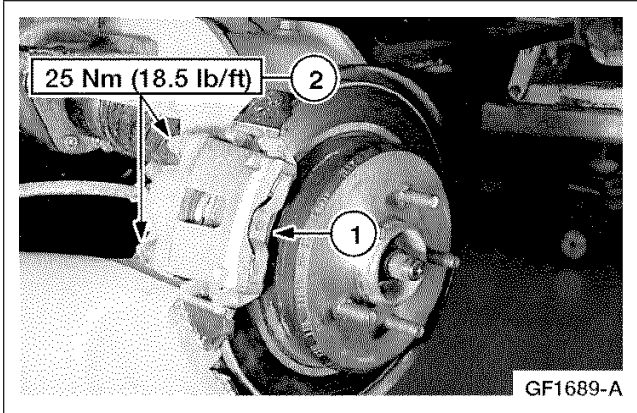

**REMOVAL AND INSTALLATION (Continued)**

7. Install the caliper
  - 1 Position the caliper.
  - 2 Install the bolts.

8. Install the wheel.
9. Lower the vehicle.

Manual Table of Contents

# SECTION 204-04 Wheels and Tires

VEHICLE APPLICATION: Ranger EV

CONTENTS	PAGE
<b>SPECIFICATIONS</b> .....	204-04-2
<b>DESCRIPTION AND OPERATION</b>	
Safety Precautions .....	204-04-2
Wheels and Tires .....	204-04-2
Tire, Temporary Spare .....	204-04-3
<b>DIAGNOSIS AND TESTING</b>	
Wheels and Tires .....	204-04-3
Inspection and Verification .....	204-04-3
Road Test.....	204-04-3
Symptom Chart .....	204-04-4
<b>GENERAL PROCEDURES</b>	
Wheel Leaks .....	204-04-5
<b>REMOVAL AND INSTALLATION</b>	
Wheel and Tire .....	204-04-6

## SPECIFICATIONS

### General Specifications

Item	Specification
<b>Tire Inflation</b>	
Tires	See safety certification sticker located on driver door jamb.
<b>Cleaners —Wheel</b>	
Custom Bright Metal Cleaner (8A-19522-A)	ESR-M5B194-B

### Torque Specifications

Description	Nm	Lb-Ft
Lug nuts 1/2-20	135	100

Torque specifications are for clean, dry bolt and nut threads. Never use oil or grease on wheel bolts or nuts.

## DESCRIPTION AND OPERATION

### Safety Precautions

**⚠ WARNING:** Never run the engine with one wheel off the ground, for example, when changing a tire. The wheel(s) resting on the ground could cause the vehicle to move.

**⚠ WARNING:** The tire and wheel must always be correctly matched. It is very important to determine the size of each component before any assembly operations commence. Failure to adhere to these instructions can result in an explosive separation and cause serious bodily injury or death.

**⚠ WARNING:** Aftermarket aerosol tire sealants are extremely flammable. Always question the customer to make sure these products have not been used.

**⚠ WARNING:** Aftermarket wheel assemblies may not be compatible with the vehicle. Use of incompatible wheel assemblies can result in equipment failure and possible injury. Use only approved wheel assemblies.

**⚠ WARNING:** Use only wheels and wheel nuts that have been designed for current model year Ford trucks. Aftermarket wheels or wheel nuts may not fit or function correctly, and can cause personal injury or damage the vehicle.

**⚠ WARNING:** Always wear safety goggles or a face shield when performing any work with tire and wheel assemblies.

**⚠ CAUTION:** Do not clean aluminum wheels with steel wool, abrasive-type cleaners or strong detergents. Use Custom Bright Metal Cleaner 8A-19522-A or equivalent meeting Ford specifications ESR-M5B194-B.

**⚠ CAUTION:** Reduce the air pressure as much as possible by pushing the valve core plunger in prior to removing the valve core. Avoid working in a position in which the face or body is directly over a tire in which there is pressure.

When performing any inspection or repair procedures on wheels (1007/1015) and tires, follow the preceding safety precautions.

### Wheels and Tires

Several types of wheel assemblies are available: stamped steel, forged aluminum and cast aluminum.

## DESCRIPTION AND OPERATION (Continued)

### Tire, Temporary Spare

 **CAUTION: Do not attempt to mount a high-pressure spare tire on a regular wheel. The high-pressure spare tire is only to be mounted on a high-pressure wheel. Limited service skin spare tires are used with standard stamped steel wheels.**

**NOTE:** Extended use of other than matching size spare tires on a Traction-Lok® rear axle could result in a permanent reduction in effectiveness. This loss of effectiveness may be noticeable to the driver as backlash and noise increase with worn clutch plates.

The temporary spare tire is designed to provide a lightweight, easy to use spare tire. It is for emergency use only and has a maximum speed capability of 80 km/h (50 mph).

## DIAGNOSIS AND TESTING

### Wheels and Tires

#### Inspection and Verification

 **WARNING: A vehicle equipped with a Traction-Lok® differential will always have both wheels driving. If, while the vehicle is being serviced, only one wheel is raised off the floor and the rear axle is driven by the engine, the wheel on the floor could drive the vehicle off the stand or jack. Be sure both rear wheels are off the floor.**

 **WARNING: Never run the engine with one wheel off the ground, for example, when changing a tire. The wheel(s) resting on the ground could cause the vehicle to move.**

 **WARNING: Do not balance the wheels and tires while they are mounted on the vehicle. Possible tire disintegration or differential failure could result, causing personal injury and extensive component damage. Use off-vehicle wheel and tire balancer only.**

Be sure to follow the warnings when performing inspection and verification.

#### Road Test

Verify the customer concern by performing a road test on a smooth road. If any vibrations are apparent, go to [Section 100-04](#).

### Tire and Wheel Runout

Excessive radial and lateral runout of a wheel and tire assembly can cause roughness, vibration, wheel tramp, tire wear and steering wheel tremor.

Before checking runout, and to avoid false readings caused by temporary flat spots in the tires, check runout only after the vehicle has been driven far enough to warm the tires. For additional information, refer to [Section 100-04](#).

To maximize tire performance, inspect for signs of incorrect inflation and uneven wear, which may indicate a need for balancing, rotation, or front suspension alignment.

Correct tire pressure and driving techniques have an important influence on tire life. Heavy cornering, excessively rapid acceleration and unnecessary sharp braking increases tire wear.

Replacement tires must follow the recommended:

- tire sizes.
- speed rating.
- load range.
- radial construction type.

Use of any other tire size or type can seriously affect:

- ride.
- handling.
- speedometer/odometer calibration.
- vehicle ground clearance.
- tire clearance between the body and chassis.
- wheel bearing life.
- brake cooling.

**DIAGNOSIS AND TESTING (Continued)**

Wheels need to be installed new when:

- bent.
- cracked.
- dented.
- heavily rusted.
- leaking.
- they have elongated wheel hub bolt holes.
- they have excessive lateral or radial runout.

Wheel and tire assemblies are attached by five noncentering wheel nuts.

It is mandatory to use only the tire sizes recommended on the tire chart attached to the vehicle. Larger or smaller tires can damage the vehicle, affect durability, and require changing the speedometer calibration. Make sure wheel size and offsets match those recommended for the tire in use.

1. Inspect for signs of uneven wear that may indicate a need for balancing, rotation, front suspension alignment, damaged tie rod, or steering components.
2. Check tires for:
  - cuts.
  - stone bruises.
  - abrasions
  - blisters.
  - embedded objects.
3. Tread wear indicators are molded into the bottom of the tread grooves. Install a new tire when the indicator bands become visible.

**Symptom Chart****Symptom Chart**

<b>Condition</b>	<b>Possible Sources</b>	<b>Action</b>
<ul style="list-style-type: none"> <li>• Tires show excess wear on edge of tread</li> </ul>	<ul style="list-style-type: none"> <li>• Underinflated tires.</li> <li>• Vehicle overloaded.</li> <li>• High-speed cornering.</li> <li>• Incorrect wheel alignment.</li> </ul>	<ul style="list-style-type: none"> <li>• ADJUST air pressure in tires.</li> <li>• RETURN vehicle. NOTIFY customer of overload condition.</li> <li>• RETURN vehicle. NOTIFY customer of cause of condition.</li> <li>• SET toe to specification. REFER to <b>Section 204-00 of the 2001 Ranger Workshop Manual.</b></li> </ul>
<ul style="list-style-type: none"> <li>• Tires show excess wear in center of tread</li> </ul>	<ul style="list-style-type: none"> <li>• Tires overinflated.</li> </ul>	<ul style="list-style-type: none"> <li>• ADJUST air pressure.</li> </ul>

**DIAGNOSIS AND TESTING (Continued)****Symptom Chart (Continued)**

<b>Condition</b>	<b>Possible Sources</b>	<b>Action</b>
<ul style="list-style-type: none"> <li>Other excessive tire wear problems</li> </ul>	<ul style="list-style-type: none"> <li>Incorrect tire pressure.</li> <li>Loose or leaking shock absorbers.</li> <li>Front end out of alignment.</li> <li>Front wheel bearings out of adjustment.</li> <li>Loose, worn or damaged suspension components.</li> <li>Wheel and tire assembly out of balance.</li> <li>Excessive lateral or radial runout of wheel or tire.</li> <li>Incorrect tire rotation intervals.</li> </ul>	<ul style="list-style-type: none"> <li>ADJUST pressure.</li> <li>TIGHTEN or INSTALL new as necessary.</li> <li>ALIGN front end. REFER to <b>Section 204-00 of the 2001 Ranger Workshop Manual.</b></li> <li>REFER to <b>Section 204-00 of the 2001 Ranger Workshop Manual</b> for inspection procedure.</li> <li>REFER to <b>Section 204-00 of the 2001 Ranger Workshop Manual.</b></li> <li>BALANCE wheel and tire assembly.</li> <li>REFER to Component Tests in this section.</li> <li>ADVISE customer of condition.</li> </ul>
<ul style="list-style-type: none"> <li>Wobble or shimmy</li> </ul>	<ul style="list-style-type: none"> <li>Damaged wheel bearings.</li> <li>Loose or damaged suspension components.</li> <li>Bent wheel.</li> <li>Damaged tire.</li> <li>Loose wheel nuts.</li> </ul>	<ul style="list-style-type: none"> <li>REFER to <b>Section 204-00 of the 2001 Ranger Workshop Manual.</b></li> <li>INSTALL new as necessary.</li> <li>INSTALL new as necessary.</li> <li>INSTALL new as necessary.</li> <li>TIGHTEN to specification.</li> </ul>
<ul style="list-style-type: none"> <li>High-speed shake</li> </ul>	<ul style="list-style-type: none"> <li>Wheel hub face/pilot/bolt circle runout.</li> <li>Tires/wheels.</li> <li>Wheel bearings.</li> <li>Suspension/steering linkage.</li> <li>Engine.</li> <li>Transmission.</li> <li>Brake discs/drums — imbalance.</li> </ul>	<ul style="list-style-type: none"> <li>REFER to <a href="#">Section 100-04</a>.</li> </ul>
<ul style="list-style-type: none"> <li>Vehicle vibration</li> </ul>	<ul style="list-style-type: none"> <li>Driveline — engine.</li> <li>Tires.</li> </ul>	<ul style="list-style-type: none"> <li>REFER to <a href="#">Section 100-04</a>.</li> </ul>

**GENERAL PROCEDURES****Wheel Leaks**

1. Pinhole leaks in cast aluminum wheels compromise wheel integrity. Install a new wheel.

---

## REMOVAL AND INSTALLATION

### Wheel and Tire

#### Removal

1. Remove the wheel cover (1130), if so equipped.

2.  **CAUTION: Do not use heat to loosen a seized lug nut. Heat can damage the wheel and wheel bearings.**

**NOTE:** Do not remove the lug nuts (1012) at this time.

With the weight of the vehicle still on the tires, loosen the lug nuts.

3. Raise the vehicle until the wheel and tire assembly clears the floor. For additional information, refer to [Section 100-02](#).
4. Remove the lug nuts.
5. Remove the wheel and tire assembly.

#### Installation

1.  **WARNING: When a wheel is installed, always remove any corrosion, dirt or foreign material present on the mounting surfaces of the wheel or the surface of the brake disc and hub (1102) that contacts the wheel. Installing wheels without correct metal-to-metal contact at the wheel mounting surfaces can cause the lug nuts to loosen and the wheel to come off while the vehicle is in motion, resulting in loss of control.**

Position the wheel and tire assembly on the vehicle.

2. Install the lug nuts loosely. Make sure the cone ends of the lug nut face inward.
3. Turn the wheel until one lug nut is at the top of the wheel hub bolt circle. Tighten the lug nut until snug. In a star-type pattern, tighten the remaining lug nuts until snug to minimize runout.

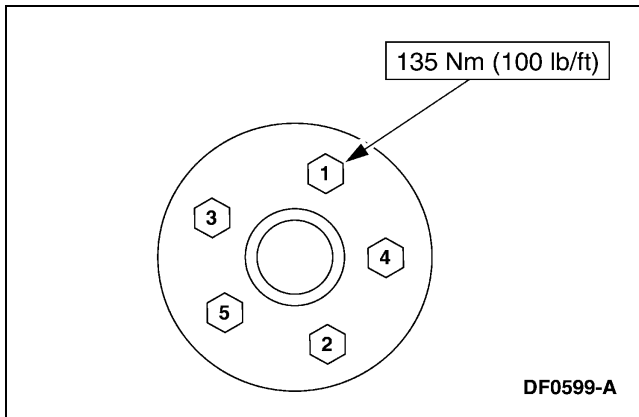
**REMOVAL AND INSTALLATION (Continued)**

4. Lower the vehicle.
5. **⚠ CAUTION: Failure to tighten the lug nuts in a star pattern can result in high brake disc runout, which will speed up the development of brake roughness, shudder and vibration.**

Tighten the lug nuts to specification.

6. Advise the customer that the wheels need to be retightened at 800 km (500 miles) after any wheel (1007) change or any other time the lug nuts have been loosened. This is required to permit the wheel clamping system to seat correctly so that the lug nuts will hold a uniform clamp load and remain fully tightened.
7. Install the wheel cover, if so equipped.



---

[Manual Table of Contents](#)

## SECTION 205-05 Rear Drive Halfshafts

VEHICLE APPLICATION: Ranger EV

CONTENTS	PAGE
SPECIFICATIONS .....	<a href="#">205-05-2</a>
REMOVAL AND INSTALLATION	
Halfshafts .....	<a href="#">205-05-2</a>

## SPECIFICATIONS

### Torque Specifications

Description	Nm	Lb-Ft
Hub Nut	252	186

## REMOVAL AND INSTALLATION

### Halfshafts

#### Special Tool(s)

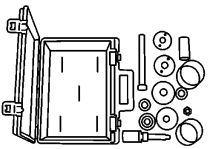
 <p>ST2087-A</p>	<p>Wheel Bearing Removal and Installation Kit or equivalent OTC-7686</p>
---	--

### Removal

1. Remove the motor/transaxle. Refer to [Section 303-01](#).
2. Remove the halfshaft hub nut and washer.
3. Remove the halfshaft.
  - Drive the halfshaft out of the hub using a brass punch and hammer.

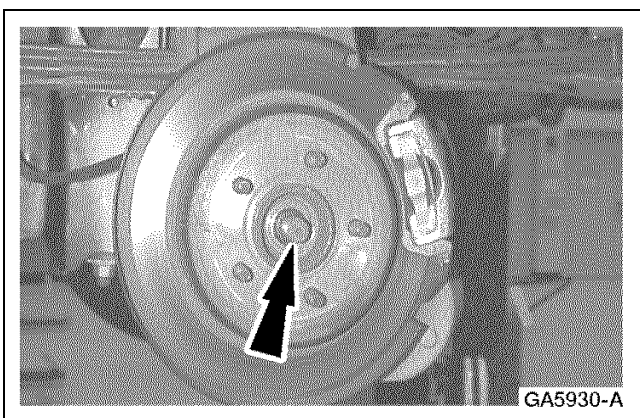
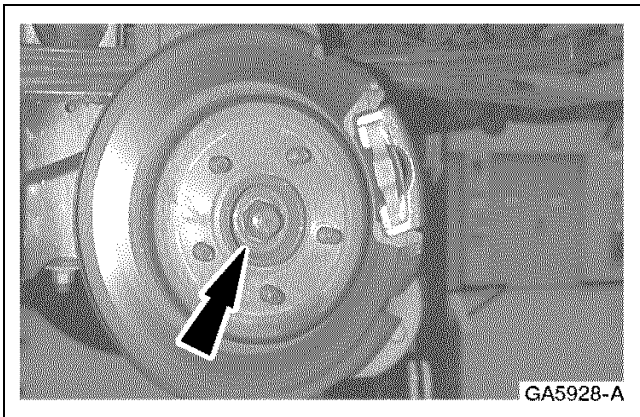

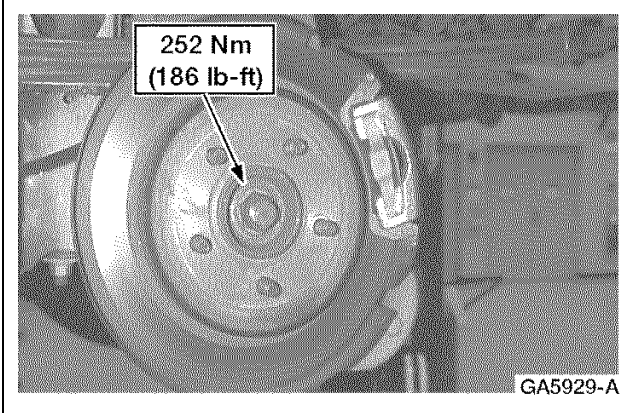
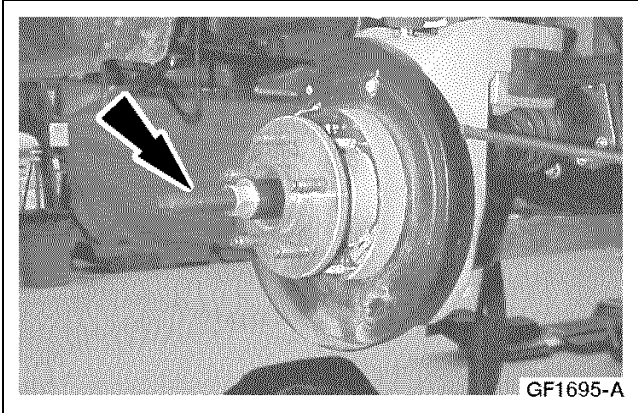
**REMOVAL AND INSTALLATION (Continued)****Installation**

1. Install the halfshaft.
  - Use the installation tool from Wheel Bearing Removal Removal and Installation Kit or equivalent.
2. Install the halfshaft end washer and nut.
  - Tighten the nut to draw the halfshaft completely into the hub.
3. Install the motor/transaxle. Refer to [Section 303-01](#).

## SECTION 206-04 Rear Disc Brake

VEHICLE APPLICATION: Ranger EV

CONTENTS	PAGE
<b>SPECIFICATIONS</b> .....	<a href="#">206-04-2</a>
<b>DESCRIPTION AND OPERATION</b>	
Rear Disc Brakes .....	<a href="#">206-04-2</a>
<b>REMOVAL AND INSTALLATION</b>	
Rear Disc Brakes —Caliper .....	<a href="#">206-04-3</a>
Rear Disc Brakes —Rotor .....	<a href="#">206-04-5</a>

## SPECIFICATIONS

### General Specifications

Item	Specification
Rear Disc Brake Lining Minimum Thickness	3.12 mm (0.125 in)
Rear Disc Brake Rotor Nominal Thickness	12 mm (0.472 in)
Rear Disc Brake Rotor Minimum Thickness	10.5 mm (0.40 in)
Maximum Rear Disc Brake Rotor Runout	0.0051 mm (0.0002 in)
Silicone Brake Caliper Grease D7AZ-19A331-A	ESE-M1C171-A

### Torque Specifications

Description	Nm	Lb-Ft
Brake Line Bolt	35	26
Caliper Bolts	25	18.5
Lug Nuts	115	85

## DESCRIPTION AND OPERATION

### Rear Disc Brakes

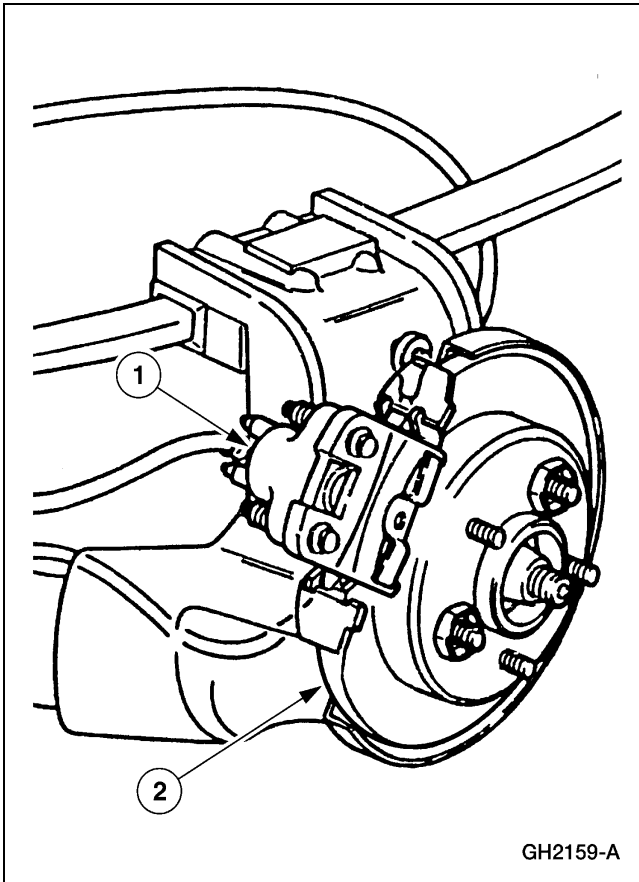

Item	Description
1	Rear Disc Brake Caliper
2	Rear Disc Brake Rotor

The rear disc brakes on the Electric Ranger are composed of Explorer calipers, rotors, and pads. The brakes are hydraulically activated and the parking brake operates independently from the disc brake system. A separate regenerative braking system uses vehicle momentum to replace energy to the drive battery. The regenerative braking system does not mechanically interact with the front or rear disc brakes.

## REMOVAL AND INSTALLATION

### Rear Disc Brakes —Caliper

#### Removal

**⚠ WARNING:** Brake fluid contains polyglycol ethers and polyglycols. Avoid contact with eyes. Wash hands thoroughly after handling. If brake fluid contacts eyes, flush eyes with running water for 15 minutes. Get medical attention if irritation persists if taken internally, drink water and induce vomiting. Get medical attention immediately.

**⚠ CAUTION:** Brake fluid is harmful to painted and plastic surfaces. If brake fluid is spilled onto a painted or plastic surface, immediately wash it with water.

1. Raise and support the vehicle. Refer to [Section 100-02](#).

2. Remove the wheel.

- 1 Remove the center cap.
- 2 Remove the lug nuts.
- 3 Remove the wheel.

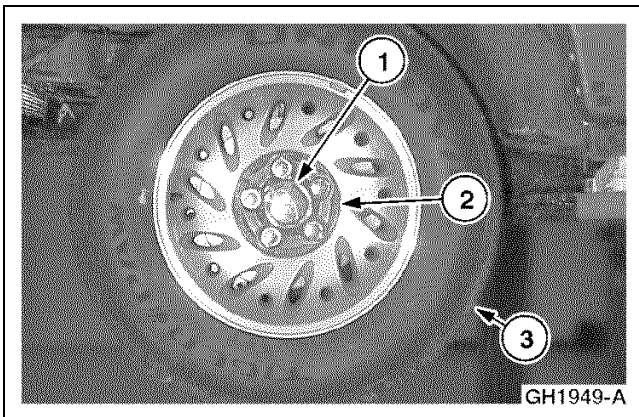

3. **⚠ CAUTION:** Do not allow brake fluid to contact the brake pads or any painted surfaces.

Disconnect the brake line.

- Remove the bolt.

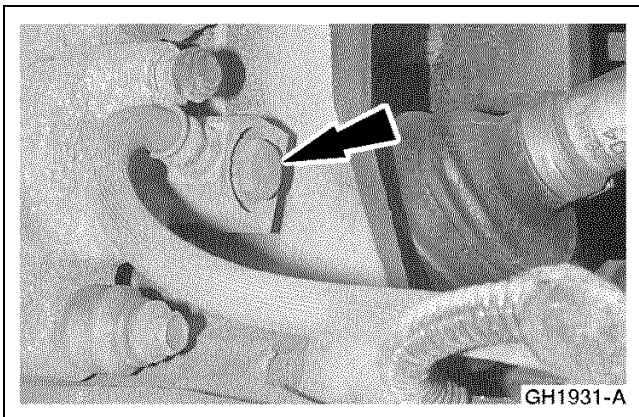

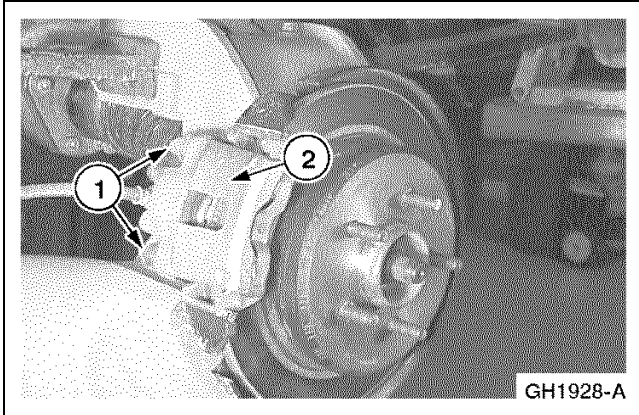
**REMOVAL AND INSTALLATION (Continued)**

4. Remove the caliper.
  - 1 Remove the bolts.
  - 2 Remove the caliper.

5. Inspect the caliper for leaks and replace if necessary.
6. Remove and clean the caliper slide pins. After cleaning, lubricate with Silicone Brake Caliper Grease D7AZ-19A331-A meeting Ford specification ESE-M1C171-A.

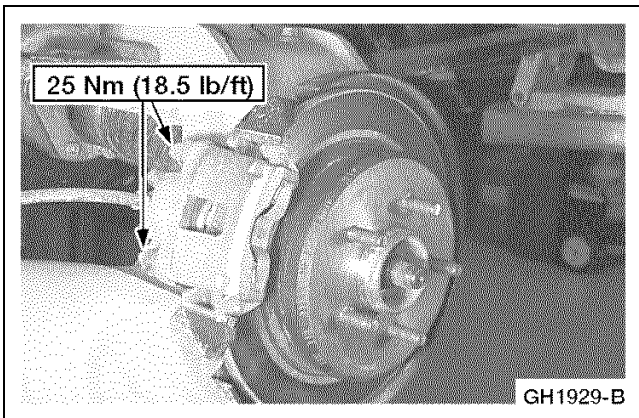
**Installation**

1. To install, reverse the removal procedure.
  - After installation, bleed the brake system to remove any air that has become trapped in the system. Refer to **Section 206-00 of the 1998 Ranger Workshop Manual**.

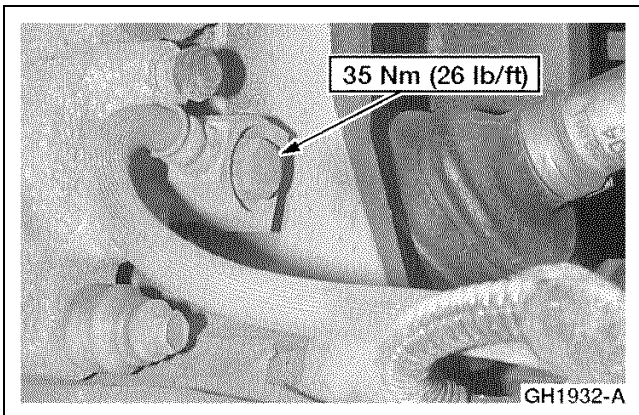

## REMOVAL AND INSTALLATION (Continued)

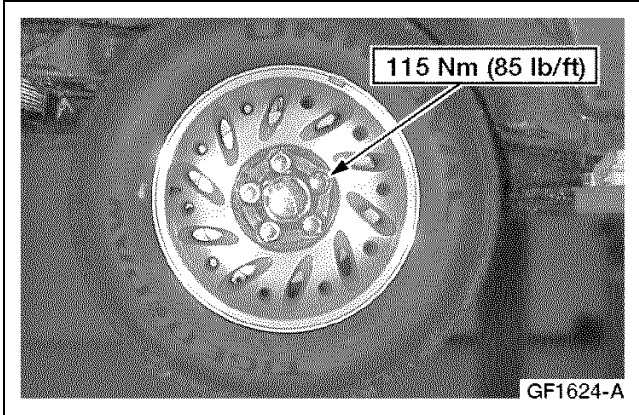

### Rear Disc Brakes —Rotor

#### Removal

**⚠ WARNING:** Brake fluid contains polyglycol ethers and polyglycols. Avoid contact with eyes. Wash hands thoroughly after handling. If brake fluid contacts eyes, flush eyes with running water for 15 minutes. Get medical attention if irritation persists if taken internally, drink water and induce vomiting. Get medical attention immediately.

**⚠ CAUTION:** Brake fluid is harmful to painted and plastic surfaces. If brake fluid is spilled onto a painted or plastic surface, immediately wash it with water.

1. Raise and support the vehicle. Refer to [Section 100-02](#).
2. Remove the rear wheel.
  - 1 Remove the center cap.
  - 2 Remove the lug nuts.
  - 3 Remove the wheel.

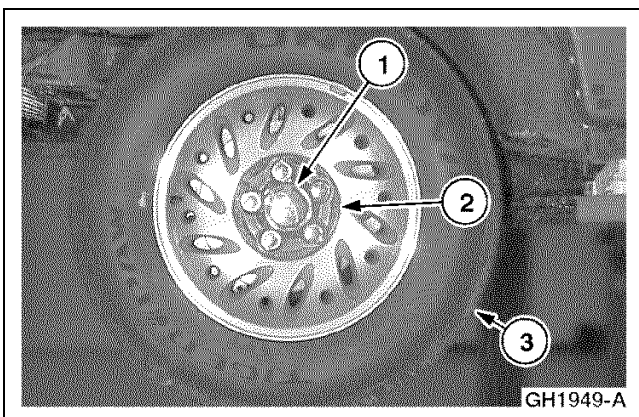

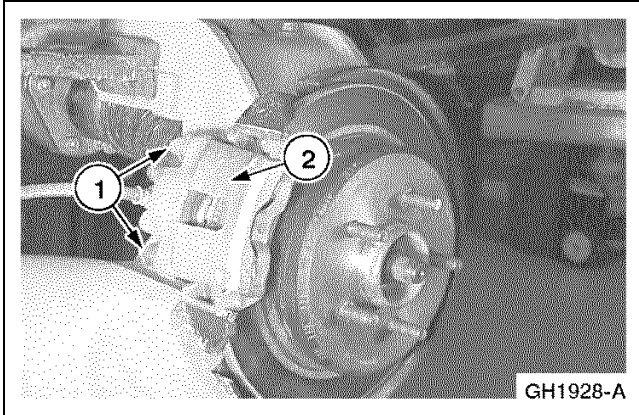

**REMOVAL AND INSTALLATION (Continued)**

3. Position the caliper.
  - 1 Remove the bolts.
  - 2 Position the caliper and support it so there is no weight on the brake hose.

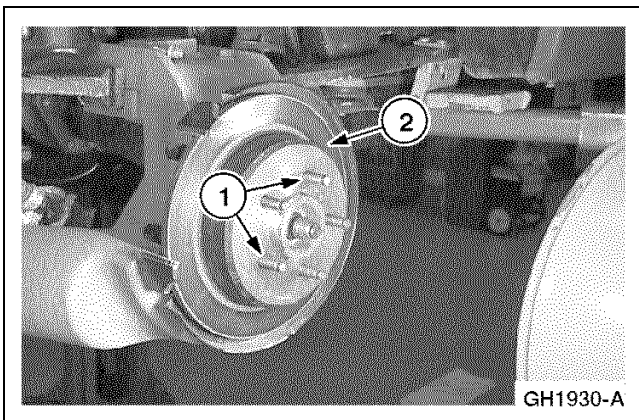

4. Remove the rotor.
  - 1 Remove the retaining clips.
  - 2 Remove the rotor.

5. Inspect the rotor. Refer to the [Specification chart](#) in this section.
  - Replace the rotor if not within specification.

**Installation**

1. To install, reverse the removal procedure.

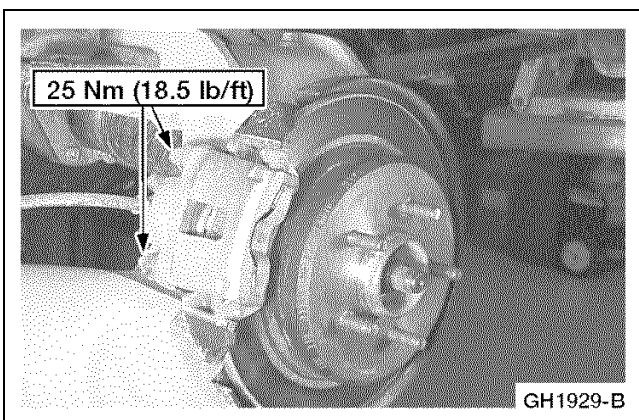

**REMOVAL AND INSTALLATION (Continued)**

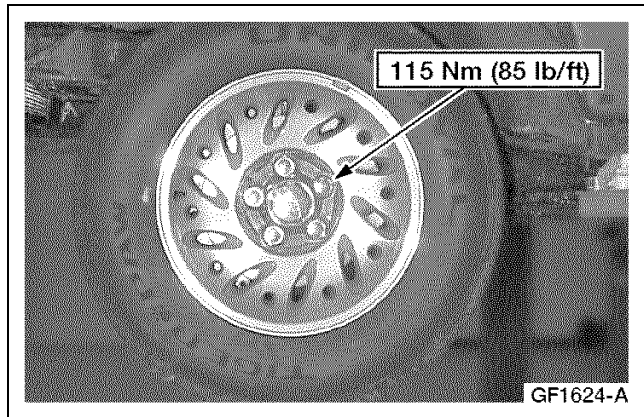

[Manual Table of Contents](#)

# SECTION 206-05 Parking Brake and Actuation

VEHICLE APPLICATION: Ranger EV

CONTENTS	PAGE
<b>SPECIFICATIONS</b> .....	<a href="#">206-05-2</a>
<b>REMOVAL AND INSTALLATION</b>	
Parking Brake Assembly .....	<a href="#">206-05-2</a>
Parking Brake Cables —Front .....	<a href="#">206-05-7</a>
Parking Brake Cables —Intermediate .....	<a href="#">206-05-9</a>
Parking Brake Cables —Postal Ranger EV .....	<a href="#">206-05-7</a>
Parking Brake Cables —Rear .....	<a href="#">206-05-10</a>

## SPECIFICATIONS

### General Specifications

Item	Specification
Parking Brake Shoe Lining Setup Diameter	0.508 mm (0.02 in)

### Torque Specifications

Description	Nm	Lb-Ft	Lb-In
Brake cable bracket bolts	12	—	108
Backing plate bolts	15	11	—

### General Specifications—Postal Ranger EV

Item	Specification
Parking Brake Shoe Lining Setup Diameter	0.508 mm (0.02 in)

### Torque Specifications—Postal Ranger EV

Description	Nm	Lb-Ft	Lb-In
Brake cable bracket bolts	12	—	108
Backing plate bolts	15	11	—
Control bracket bolts	28	21	—
Parking brake cable bracket bolts	11	8	—

## REMOVAL AND INSTALLATION

### Parking Brake Assembly

#### Special Tool(s)

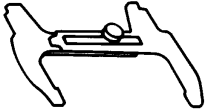
 ST1468-A	Brake Adjusting Gauge or equivalent 206-D002 (D81L-1103-A)
---	---

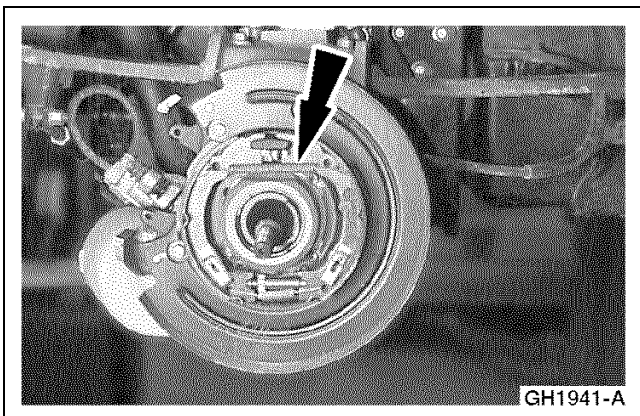

1. Remove the hub. Refer to [Section 204-02](#).
2. Remove the upper shoe spring.

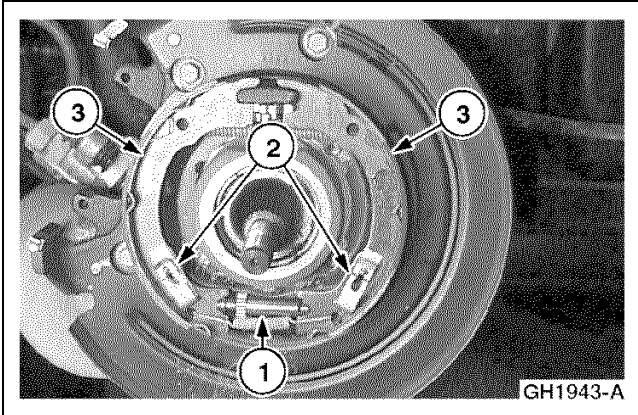
**REMOVAL AND INSTALLATION (Continued)**

3. Remove the brake shoes.
  - 1 Remove the lower spring and adjuster.
  - 2 Remove the shoe retaining clips.
  - 3 Remove the brake shoes.

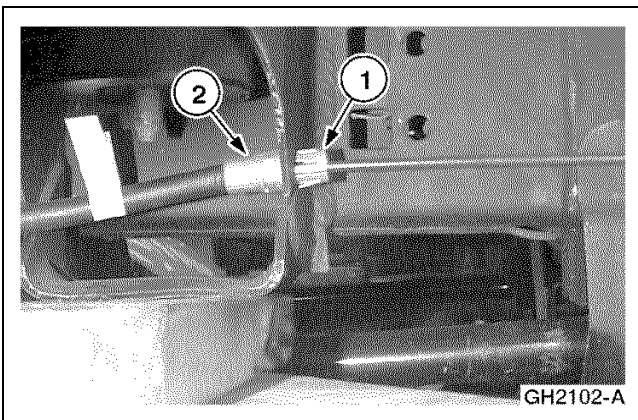

4. Release tension on the parking brake cable.
  - 1 Compress the retainer.
  - 2 Remove the parking brake cable from the bracket.

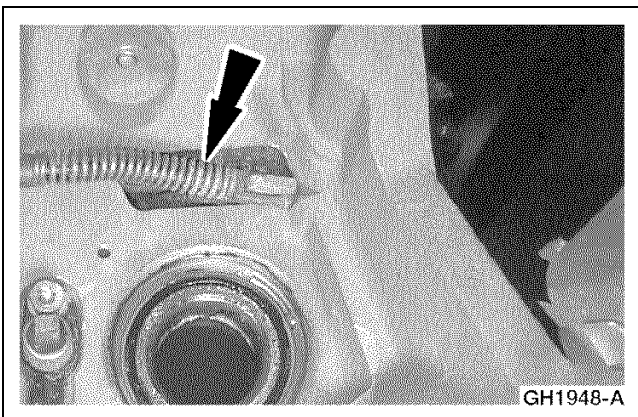

5. Disconnect the parking brake cable.

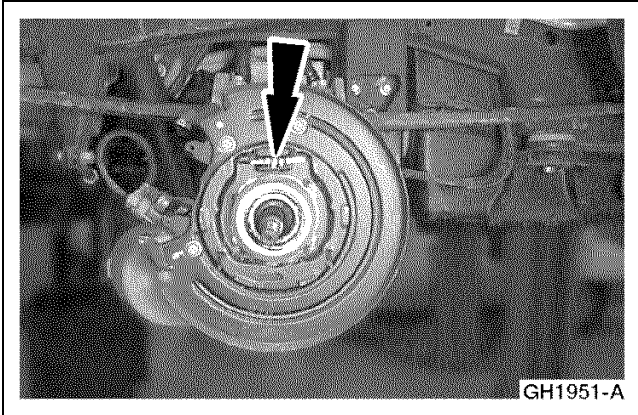
**REMOVAL AND INSTALLATION (Continued)**

6. Remove the parking brake linkage.

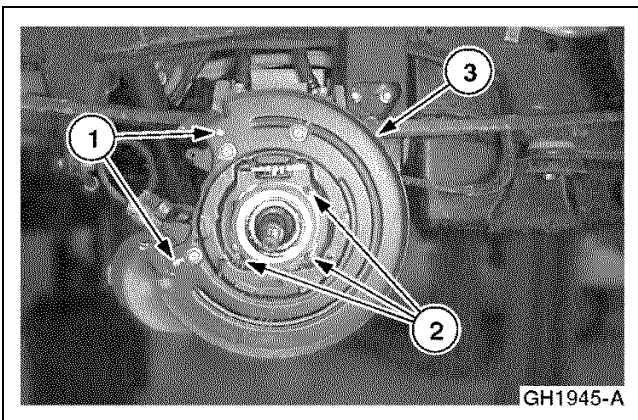

7. Remove the backing plate.
  - 1 Drill out the two rivet heads.
  - 2 Remove the three bolts.
  - 3 Remove the backing plate.

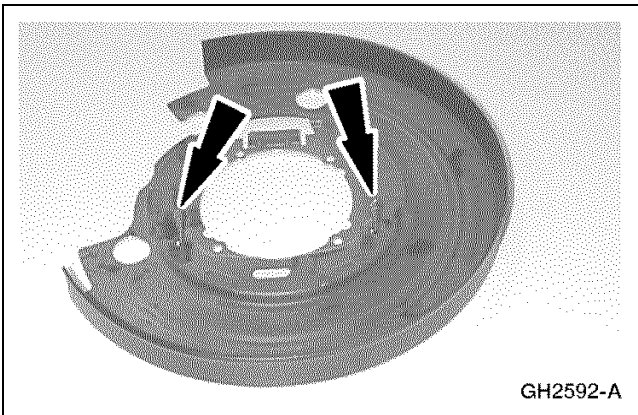
**Installation**

1. Install new brake shoe retaining pins in the backing plate.

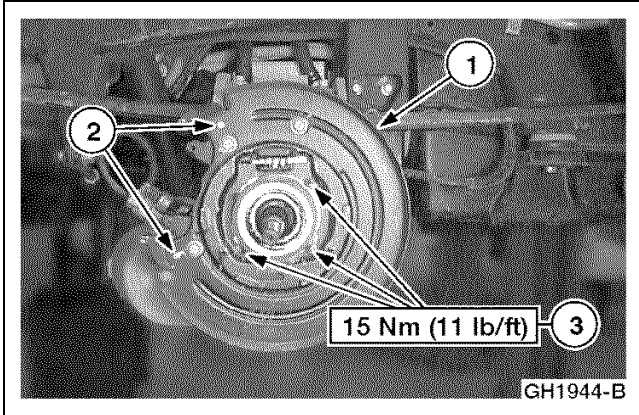
**REMOVAL AND INSTALLATION (Continued)**

2. Install the backing plate.
  - 1 Position the backing plate.
  - 2 Install two new rivets.
  - 3 Install the three bolts.

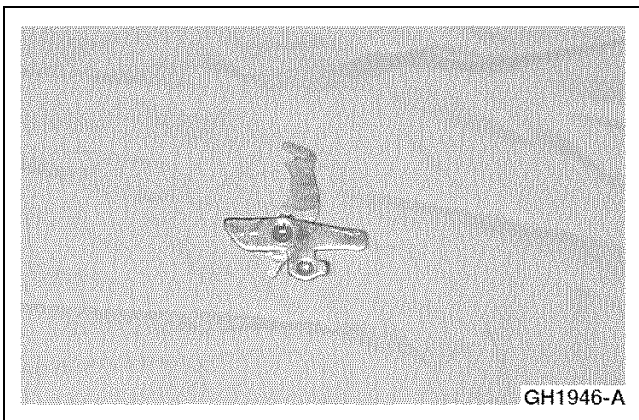

3. Assemble the parking brake linkage.

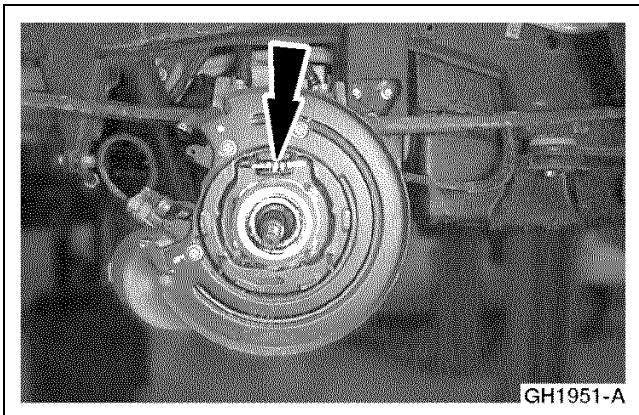

4. **NOTE:** Position the linkage that connects to the cable facing down.  
Install the parking brake linkage.

## REMOVAL AND INSTALLATION (Continued)

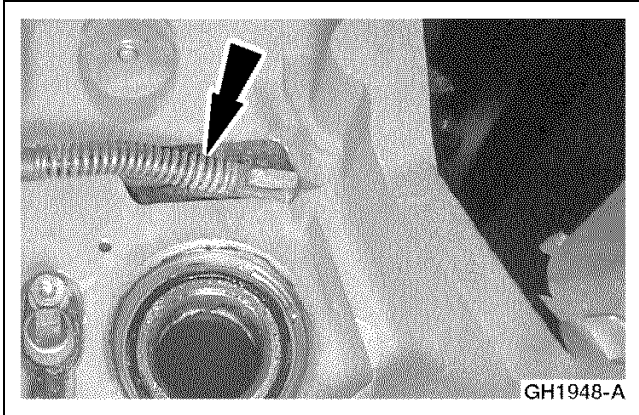

5. Connect the parking brake cable.

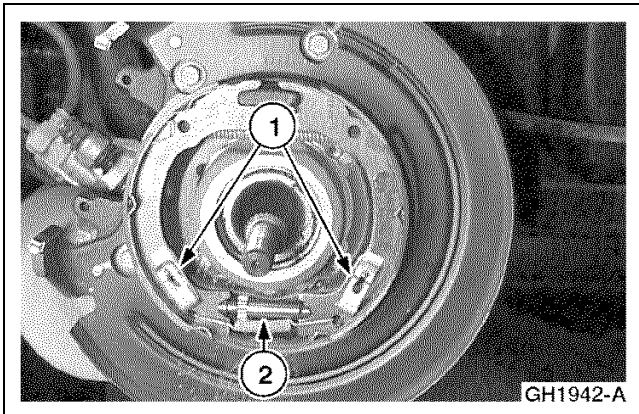

6. Install the inside upper brake shoe spring on the brake shoes.
7. **NOTE:** The inside upper brake shoe spring must be installed prior to positioning the brake shoes.

Position the brake shoes and install the adjuster and spring.

- 1 Install the retaining clips.
- 2 Position the adjuster and install the spring.

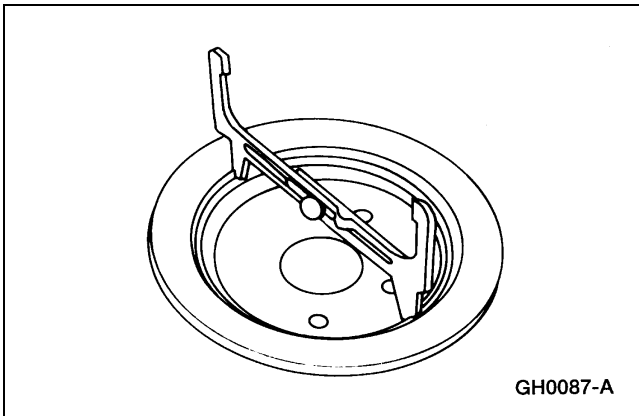

8. Use Brake Adjusting Gauge to measure the inside diameter of the drum portion of the rear disc brake rotor.

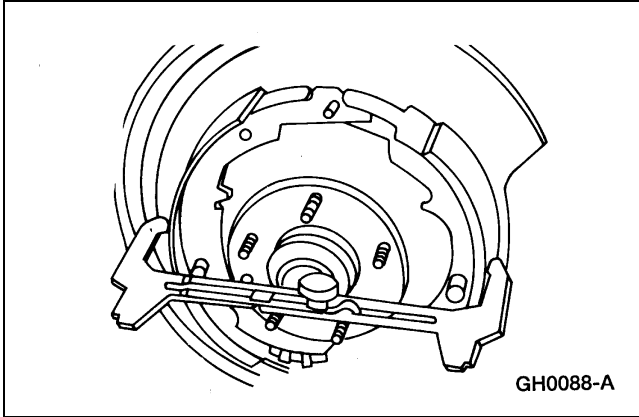

**REMOVAL AND INSTALLATION (Continued)**

9. Use Brake Adjusting Gauge to set the rear brake shoe and lining to 0.508 mm (0.02 in) less than the inside diameter of the drum portion of the rear disc brake rotor.
  - Rotate the adjusting screw as necessary.

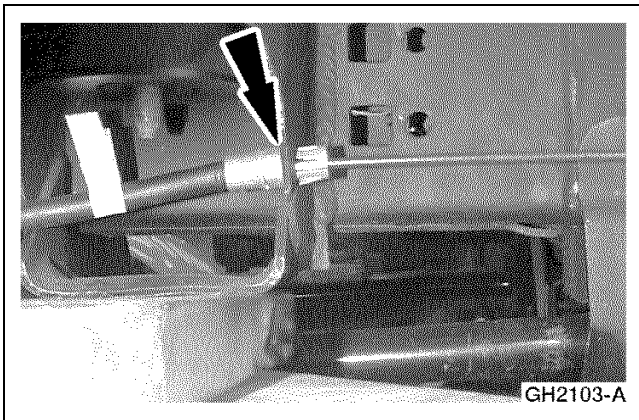

10. Position the parking brake cable in the bracket.

11. Install the hub. Refer to [Section 204-02](#).

**Parking Brake Cables —Front****Removal**

1. The parking brake control cables on the Electric Ranger are carryover from the standard Ranger. Refer to **Section 206-05 of the 2001 Ranger Workshop Manual**.

**Parking Brake Cables —Postal Ranger EV****Removal and Installation**

1. Raise and support the vehicle. For additional information, refer to [Section 100-02](#)

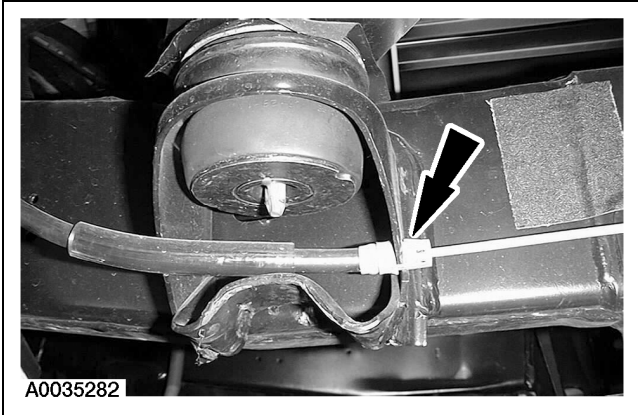
**REMOVAL AND INSTALLATION (Continued)**

2. Remove the front cable from the bracket.

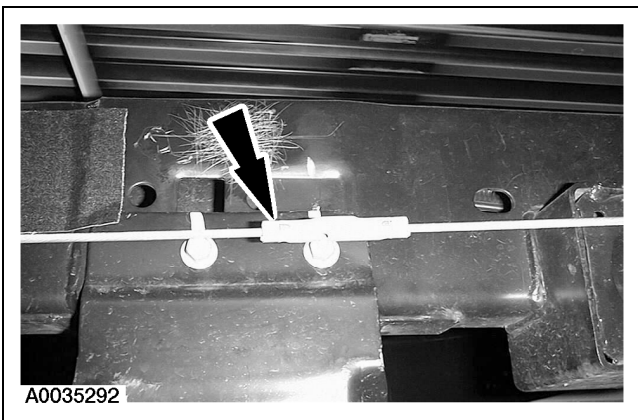

3. Remove the front cable from the rear cable.

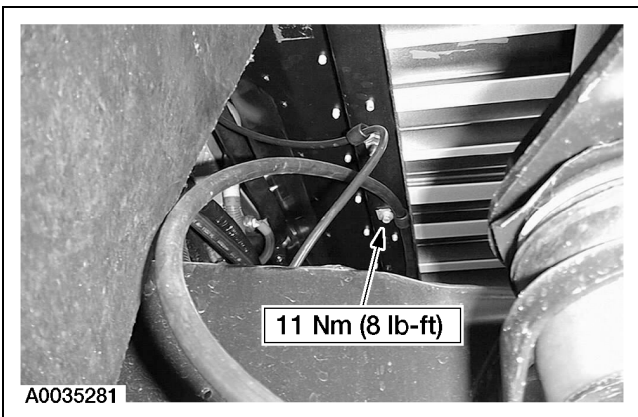

4. Remove the front cable hold-down bolt.

5. Lower the vehicle.

## REMOVAL AND INSTALLATION (Continued)

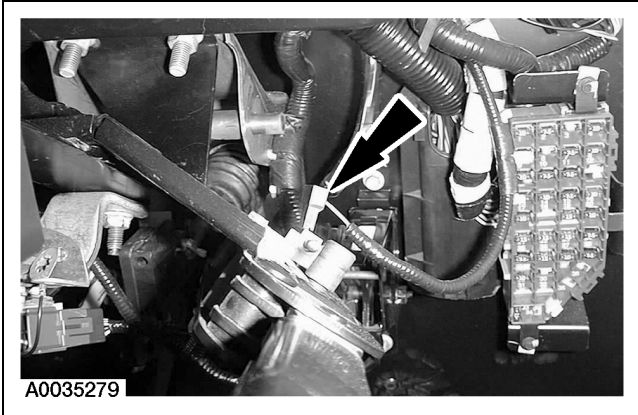

6. Disconnect the parking brake control switch electrical connector.

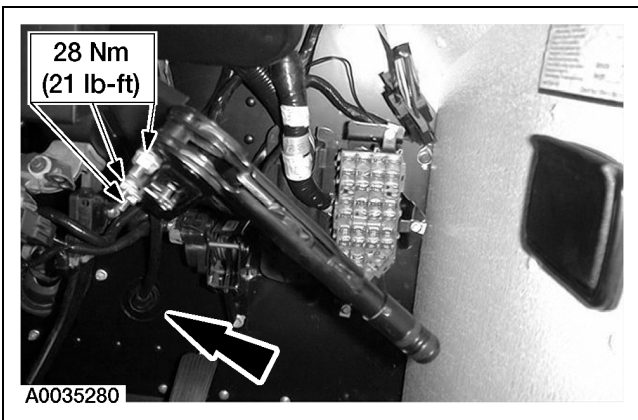

7. Remove the three bolts, loosen the grommet from the bulkhead and remove the parking brake control assembly.

8. Remove the front cable from the control assembly.

9. To install, reverse the removal procedure.

## Parking Brake Cables —Intermediate

### Removal

1. The intermediate cable on the Electric Ranger is carryover from the standard Ranger. Refer to **Section 206-05 of the 2001 Ranger Workshop Manual.**

## REMOVAL AND INSTALLATION (Continued)

### Parking Brake Cables —Rear

#### Removal

1. Remove the traction battery. Refer to [Section 414-03A](#) or [Section 414-03B](#).
2. Release tension on the parking brake cable.
  - 1 Compress the retainer.
  - 2 Remove the front parking brake cable from the bracket.

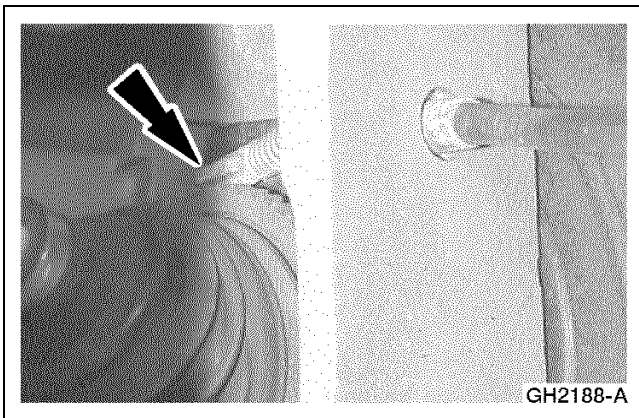
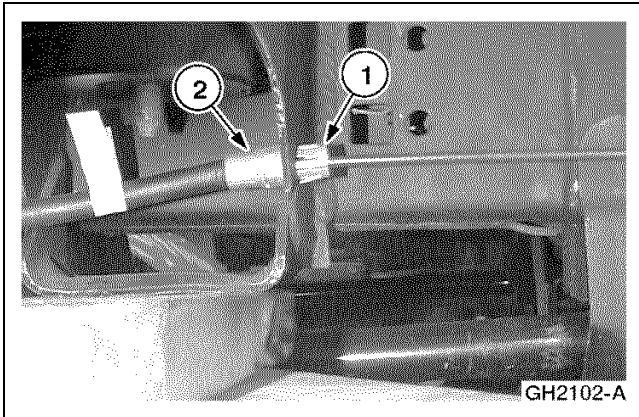

3. **NOTE:** RH shown, LH similar.  
Disconnect the LH and RH parking brake cables.

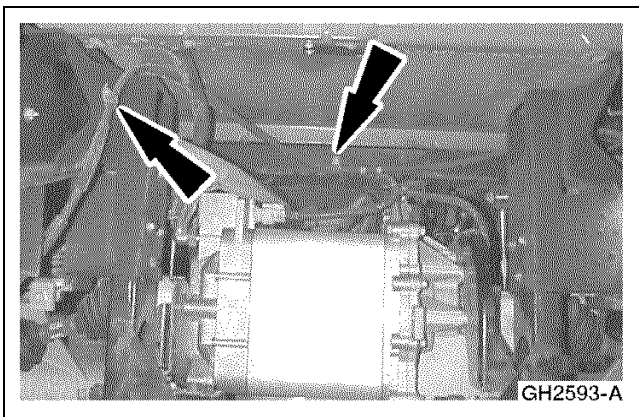

4. Remove the two RH brake cable bracket bolts (RH only).

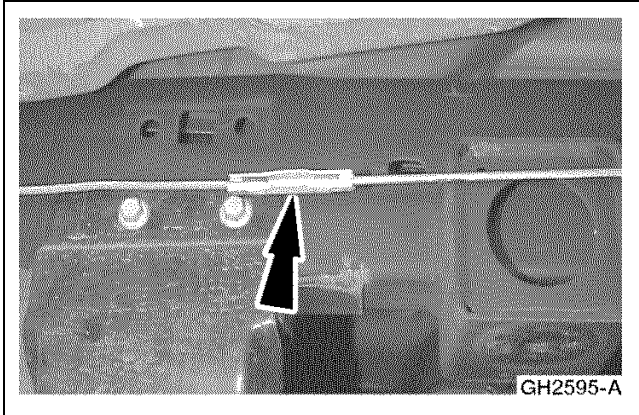
**REMOVAL AND INSTALLATION (Continued)**

5. Disconnect the rear brake cable from the intermediate brake cable.



6. Remove the rear parking brake cable.
  - Disconnect the parking brake cable.

**Installation**

1. To install, reverse the removal procedure.

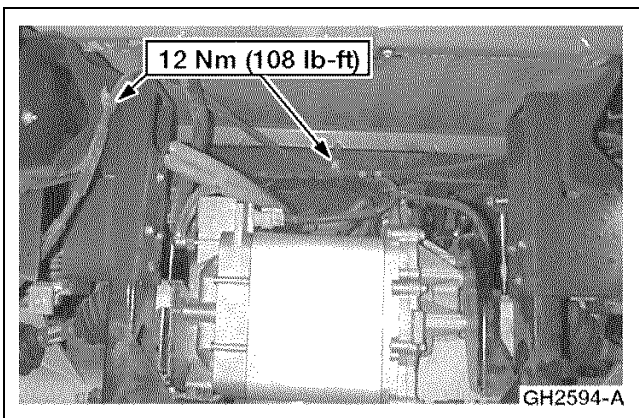

[Manual Table of Contents](#)

# SECTION 206-07 Power Brake Actuation

VEHICLE APPLICATION: Ranger EV

CONTENTS	PAGE
<b>SPECIFICATIONS</b> .....	206-07-2
<b>DESCRIPTION AND OPERATION</b>	
Power Disc Brake Actuation .....	206-07-2
<b>DIAGNOSIS AND TESTING</b>	
Vacuum System .....	206-07-3
Electrical Schematic .....	206-07-3
Inspection and Verification .....	206-07-3
Pinpoint Tests.....	206-07-4
Symptom Chart.....	206-07-3
<b>REMOVAL AND INSTALLATION</b>	
Vacuum Pressure Sensor .....	206-07-8
Vacuum Pump.....	206-07-10

## SPECIFICATIONS

### Torque Specifications

Description	Nm	Lb-Ft	Lb-In
Battery Ground Cable	8	—	71
Vacuum Pump Bracket Bolts	22	16	—

(Continued)

### Torque Specifications

Description	Nm	Lb-Ft	Lb-In
Vacuum Pressure Sensor to Vacuum Tee Screws	5.5	—	49
Vacuum Pressure Sensor Bolt	22	16	—

## DESCRIPTION AND OPERATION

### Power Disc Brake Actuation

#### Card Table Bottom View

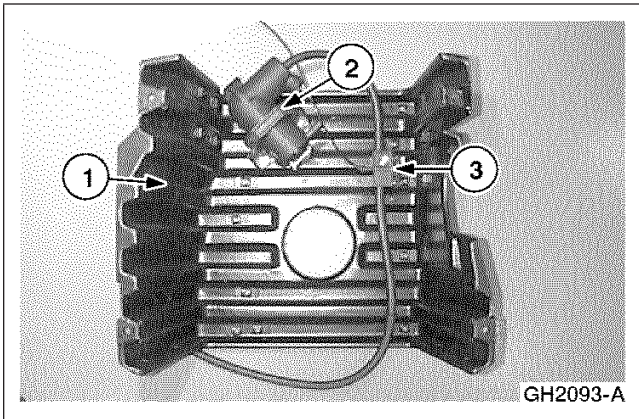

Item	Part Number	Description
1	—	Card Table
2	—	Vacuum Pump
3	—	Vacuum Pressure Sensor

The Electric Vehicle uses a conventional vacuum-assisted hydraulic brake system. All vacuum necessary for the brake system and climate control operation is supplied by an electrically operated vacuum pump. The pump is driven by an electric motor and is controlled by the interface adapter assembly (IAA) module. A vacuum signal is sent to the IAA module from a vacuum pressure sensor located in the vacuum line from the pump. The pump and the vacuum pressure sensor are mounted on the bottom side of the card table, underneath the traction battery charger. The vacuum pump should be replaced every 5 years or 60,000 miles.

The vacuum pressure sensor measures absolute pressure. The IAA module reports pressure in the system as the difference between system pressure and absolute zero pressure. Based upon the absolute zero scale, ambient pressure is about 100 kPa (14.5 psi). Any pressure less than 100 kPa (14.5 psi) is defined as vacuum. The smaller the reading, the higher the amount of vacuum.

Power is supplied to the vacuum pump when the key is in the RUN or START position. The IAA module reads the vacuum signal sent by the vacuum pressure sensor and opens and closes a relay to operate the vacuum pump. The vacuum pump cycles in order to maintain a set amount of pressure that ranges from 26-34 kPa (3.8-4.9 psi).

## DIAGNOSIS AND TESTING

### Vacuum System

#### Diagnostic Trouble Code (DTC) Definition

The following DTC relates to the vacuum system:

- DTC C1777 Vacuum Pressure Circuit Failure
  - The interface adapter assembly (IAA) module uses the vacuum pressure sensor to monitor the pressure in the vacuum system. The normal operating pressure of the vacuum system is 26-34 kPa (3.8-4.9 psia). The normal range of the vacuum pressure sensor is 15-105 kPa (2.2-15.2 psia). The IAA module sets DTC C1777 if the brake pedal has not been pressed for 30 seconds and the vacuum pressure is less than 15 kPa (2.2 psia) or if the brake pedal has not been pressed and the vacuum pump has run continuously for more than five minutes. DTC C1777 is also set if the vacuum pressure is greater than 93.5 kPa (13.6 psia) and the vacuum pump has run continuously for more than five minutes. If this occurs, the IAA module operates the vacuum pump at limited operating strategy (LOS) mode defined as six seconds every two minutes, and for a preset time each time the brake pedal is depressed or released.

#### Electrical Schematic

Refer to **Electrical and Vacuum Troubleshooting Manual, Cell 139, Vacuum System** for schematic and connector information.

#### Inspection and Verification

Refer to [Section 100-07](#).

### Symptom Chart

#### Symptom Chart

Condition	Possible Sources	Action
<ul style="list-style-type: none"> <li>• DTC C1777 Vacuum Pressure Circuit Failure</li> </ul>	<ul style="list-style-type: none"> <li>• Fuse.</li> <li>• Circuit(s).</li> <li>• Vacuum pump.</li> <li>• Vacuum pump relay.</li> <li>• Vacuum pressure sensor.</li> <li>• Interface adapter assembly (IAA) module.</li> </ul>	<ul style="list-style-type: none"> <li>• GO to <a href="#">Pinpoint Test A</a>.</li> </ul>
<ul style="list-style-type: none"> <li>• Excessive Brake Pedal Effort to Stop Vehicle</li> </ul>	<ul style="list-style-type: none"> <li>• Vacuum pump.</li> <li>• Mechanical brake system.</li> </ul>	<ul style="list-style-type: none"> <li>• GO to <a href="#">Pinpoint Test B</a>.</li> </ul>
<ul style="list-style-type: none"> <li>• Vacuum Pump Cycles on and off Without Brake Pedal or Climate Control Activation (Vacuum System Leak Test)</li> </ul>	<ul style="list-style-type: none"> <li>• Climate control vacuum system.</li> <li>• Brake booster.</li> <li>• Brake booster check valve.</li> <li>• Brake booster vacuum hose.</li> <li>• Vacuum tee assembly.</li> </ul>	<ul style="list-style-type: none"> <li>• GO to <a href="#">Pinpoint Test C</a>.</li> </ul>



**DIAGNOSIS AND TESTING (Continued)****Symptom Chart (Continued)**

Condition	Possible Sources	Action
<ul style="list-style-type: none"> <li>Vacuum Pump Exhibits Unusual or Excessive Noise</li> </ul>	<ul style="list-style-type: none"> <li>Vacuum pump.</li> <li>Incorrect vacuum pump bracket bolt torque specifications.</li> <li>Incorrect vacuum pump installation.</li> </ul>	<ul style="list-style-type: none"> <li>GO to <a href="#">Pinpoint Test D</a>.</li> </ul>

**Pinpoint Tests****Special Tool(s)**

104-Pin Breakout Box (BOB) 418-049 (014-00950) or equivalent
--

**PINPOINT TEST A: DTC C1777 VACUUM PRESSURE CIRCUIT FAILURE**

TEST STEP	ACTION TO TAKE
<b>A1 IDENTIFY SYMPTOM</b> <ul style="list-style-type: none"> <li>With key ON, depress the brake pedal.</li> </ul> <p><b>NOTE:</b> DTC C1777 is set if the vacuum pump does not operate, runs continuously without cycling on and off, or cycles on and off without brake pedal or climate control activation.</p> <ul style="list-style-type: none"> <li>Identify the symptom of the vacuum system operation.</li> <li><b>Does the vacuum pump operate?</b></li> </ul>	Yes = GO to <b>A12</b> . No = GO to <b>A2</b> .
<b>A2 CHECK VACUUM PUMP OPERATION</b> <ul style="list-style-type: none"> <li>Enter the interface adapter assembly (IAA) module active command mode THERMAL REGULATION OUTPUT CONTROL and set the active command VAC RLY to ON.</li> <li><b>Does the vacuum pump operate?</b></li> </ul>	Yes = GO to <b>A3</b> . No = GO to <b>A6</b> .
<b>A3 CHECK INTERFACE ADAPTER ASSEMBLY (IAA) MODULE</b> <ul style="list-style-type: none"> <li>With key OFF, disconnect vacuum pressure sensor C1997.</li> <li>Connect 104-Pin Breakout Box (BOB) to the IAA module and IAA module C1945.</li> <li>With key ON, monitor the IAA module PID VACPRES.</li> <li>Connect a jumper wire between BOB pins 4 and 88.</li> <li><b>Does the VACPRES PID indicate greater than 80 kPa (11.6 psi)?</b></li> </ul>	Yes = GO to <b>A4</b> . No = REPLACE the IAA module. REFER to <a href="#">Section 412-04</a> .
<b>A4 CHECK CIRCUITS 3032 (DB/LG) AND 3033 (BK/LB) FOR OPEN(S)</b> <ul style="list-style-type: none"> <li>With key OFF, measure the resistance of the DB/LG wire between vacuum pressure sensor C1997 and BOB pin 4.</li> <li>With key OFF, measure the resistance of the BK/LB wire between vacuum pressure sensor C1997 and BOB pin 88.</li> <li><b>Are the resistances less than 5 ohms?</b></li> </ul>	Yes = GO to <b>A5</b> . No = REPAIR the wire(s) in question.
<b>A5 CHECK CIRCUITS 3032 (DB/LG) AND 3033 (BK/LB) FOR SHORT(S) TO GROUND</b> <ul style="list-style-type: none"> <li>With key OFF, disconnect the IAA module from the BOB; leave BOB connected to IAA module C1945.</li> <li>With key OFF, measure the resistance between BOB pins 4, 88 and ground.</li> <li><b>Are the resistances greater than 10,000 ohms?</b></li> </ul>	Yes = REPLACE the vacuum pressure sensor. No = REPAIR the wire(s) in question.
<b>A6 CHECK FUSE AND POWER TO VACUUM PUMP RELAY</b> <ul style="list-style-type: none"> <li>With key OFF, check 20A fuse 13 in the electric vehicle power distribution box (EVPDB).</li> </ul>	Yes = RECONNECT the vacuum pump relay. GO to <b>A7</b> .

(Continued)

**DIAGNOSIS AND TESTING (Continued)****PINPOINT TEST A: DTC C1777 VACUUM PRESSURE CIRCUIT FAILURE**

TEST STEP	ACTION TO TAKE
<ul style="list-style-type: none"> <li>With key OFF, remove the vacuum pump relay from the EVPDB and measure the voltage between pins 1, 3 on the vacuum pump relay connector and ground. (V &gt; 10 volts)</li> <li><b>Is everything OK?</b></li> </ul>	No = REPAIR as necessary.
<b>A7 CHECK POWER TO VACUUM PUMP</b> <ul style="list-style-type: none"> <li>With key OFF, disconnect vacuum pump C1996.</li> <li>Enter the IAA module active command mode THERMAL REGULATION OUTPUT CONTROL, set the active command VAC RLY to ON, and measure the voltage between the LB/O wire and BK wire on vacuum pump C1996.</li> <li><b>Is the voltage greater than 10 volts?</b></li> </ul>	Yes = REPLACE the vacuum pump. No = GO to <b>A8</b> .
<b>A8 CHECK GROUND TO VACUUM PUMP</b> <ul style="list-style-type: none"> <li>With key OFF, measure the resistance between the BK wire on vacuum pump C1996 and ground.</li> <li><b>Is the resistance less than 5 ohms?</b></li> </ul>	Yes = GO to <b>A9</b> . No = REPAIR the BK wire.
<b>A9 CHECK VACUUM PUMP RELAY CONTROL CIRCUIT</b> <ul style="list-style-type: none"> <li>With key OFF, remove the vacuum pump relay from the EVPDB.</li> <li>Enter the IAA module active command mode THERMAL REGULATION OUTPUT CONTROL, set the active command VAC RLY to ON, and measure the resistance between pin 2 on the vacuum pump relay connector and ground.</li> <li><b>Is the resistance less than 5 ohms?</b></li> </ul>	Yes = GO to <b>A11</b> . No = GO to <b>A10</b> .
<b>A10 CHECK CIRCUIT 3021 (GY/BK) FOR OPEN</b> <ul style="list-style-type: none"> <li>Connect 104-Pin Breakout Box (BOB) to IAA module C1945; leave IAA module disconnected.</li> <li>With key OFF, measure the resistance of the GY/BK wire between pin 2 on the vacuum pump relay connector and BOB pin 30.</li> <li><b>Is the resistance less than 5 ohms?</b></li> </ul>	Yes = REPLACE the IAA module. = REFER to <a href="#">Section 412-04</a> . No = REPAIR the GY/BK wire.
<b>A11 CHECK CIRCUIT 3230 (LB/O) FOR OPEN</b> <ul style="list-style-type: none"> <li>With key OFF, measure the resistance of the LB/O wire between vacuum pump C1996 and pin 5 on the vacuum pump relay connector.</li> <li><b>Is the resistance less than 5 ohms?</b></li> </ul>	Yes = REPLACE the vacuum pump relay. No = REPAIR the LB/O wire.
<b>A12 CHECK VACUUM PRESSURE</b> <ul style="list-style-type: none"> <li>With key ON, monitor the interface adapter assembly (IAA) module PID VACPRES.</li> <li><b>Is the VACPRES PID less than 18 kPa (2.6 psi)?</b></li> </ul>	Yes = GO to <b>A13</b> . No = If VACPRES PID is greater than 80 kPa (11.6 psi) and is not fluctuating, GO to <b>A16</b> .  If VACPRES PID is greater than 80 kPa (11.6 psi) and is fluctuating, CHECK for vacuum system leaks. GO to <a href="#">Pinpoint Test C</a> .
<b>A13 CHECK CIRCUIT 3230 (LB/O) FOR SHORT TO POWER</b> <ul style="list-style-type: none"> <li>Remove the vacuum pump relay from the electric vehicle power distribution box (EVPDB).</li> <li><b>Does the vacuum pump stop running?</b></li> </ul>	Yes = GO to <b>A14</b> . No = REPAIR the LB/O wire.
<b>A14 CHECK VACUUM PUMP RELAY</b>	

(Continued)

**DIAGNOSIS AND TESTING (Continued)****PINPOINT TEST A: DTC C1777 VACUUM PRESSURE CIRCUIT FAILURE**

TEST STEP	ACTION TO TAKE
<ul style="list-style-type: none"> <li>Measure the resistance between terminals 3 and 5 on the vacuum pump relay.</li> <li><b>Is the resistance less than 5 ohms?</b></li> </ul>	Yes = REPLACE the vacuum pump relay. No = GO to <b>A15</b> .
<b>A15 CHECK CIRCUIT 3021 (GY/BK) FOR SHORT TO GROUND</b> <ul style="list-style-type: none"> <li>With key OFF, disconnect IAA module C1945 and measure the resistance between pin 2 on the vacuum pump relay connector and ground.</li> <li><b>Is the resistance greater than 10,000 ohms?</b></li> </ul>	Yes = REPLACE the IAA module. = REFER to <a href="#">Section 412-04</a> . No = REPAIR the GY/BK wire.
<b>A16 CHECK VACUUM PRESSURE SENSOR</b> <ul style="list-style-type: none"> <li>Connect 104-Pin Breakout Box (BOB) to the IAA module and IAA module C1945.</li> <li>With key ON, measure the voltage between BOB pins 4 and 89.</li> <li><b>Is the voltage greater than 4.2 volts?</b></li> </ul>	Yes = GO to <b>A18</b> . No = GO to <b>A17</b> .
<b>A17 CHECK VACUUM PRESSURE</b> <ul style="list-style-type: none"> <li>With key ON, monitor the interface adapter assembly (IAA) module PID VACPRES.</li> <li><b>Is the VACPRES PID greater than 80 kPa (11.6 psi)?</b></li> </ul>	Yes = REPLACE the IAA module. = REFER to <a href="#">Section 412-04</a> . No = System OK. CHECK wiring for intermittent connections.
<b>A18 CHECK CIRCUITS 3032 (DB/LG), 3033 (BK/LB), AND 3034 (LG/R) FOR SHORT(S) TO POWER</b> <ul style="list-style-type: none"> <li>With key OFF, disconnect the IAA module from the BOB; leave BOB connected to IAA module C1945.</li> <li>With key ON, measure the voltage between BOB pins 4, 88, 89, and ground.</li> <li><b>Are any of the voltages greater than 0 volts?</b></li> </ul>	Yes = REPAIR the wire(s) in question. No = GO to <b>A19</b> .
<b>A19 CHECK CIRCUIT 3034 (LG/R) FOR OPEN</b> <ul style="list-style-type: none"> <li>With key OFF, measure the resistance of the LG/R wire between vacuum pressure sensor C1997 and BOB pin 89.</li> <li><b>Is the resistance less than 5 ohms?</b></li> </ul>	Yes = REPLACE the vacuum pressure sensor. No = REPAIR the LG/R wire.

**PINPOINT TEST B: EXCESSIVE BRAKE PEDAL EFFORT TO STOP VEHICLE**

TEST STEP	ACTION TO TAKE
<b>B1 CHECK FOR INTERFACE ADAPTER ASSEMBLY (IAA) MODULE DIAGNOSTIC TROUBLE CODES (DTCs)</b> <ul style="list-style-type: none"> <li>Retrieve DTCs from the IAA module.</li> <li><b>Does DTC C1777 Vacuum Pressure Circuit Failure occur?</b></li> </ul>	Yes = GO to <a href="#">Pinpoint Test A</a> . No = GO to <b>B2</b> .
<b>B2 CHECK VACUUM PUMP PERFORMANCE</b> <ul style="list-style-type: none"> <li>With key OFF, disconnect the vacuum hose at the vacuum pump.</li> <li>Depress the brake pedal until the pedal is hard to press.</li> <li>Reconnect the vacuum hose to the vacuum pump.</li> <li>Monitor the IAA module PID VACPRES and note the time it takes the vacuum pressure to reach 34 kPa (4.9 psi).</li> <li><b>Does the vacuum pressure reach 34 kPa (4.9 psi) in less than 18 seconds?</b></li> </ul>	Yes = PERFORM mechanical brake diagnostics. REFER to <b>Section 206-00 in the 2001 Ranger Workshop Manual</b> . No = REPLACE the vacuum pump.

**DIAGNOSIS AND TESTING (Continued)****PINPOINT TEST C: VACUUM PUMP CYCLES ON AND OFF WITHOUT BRAKE PEDAL OR CLIMATE CONTROL ACTIVATION (VACUUM SYSTEM LEAK TEST)**

TEST STEP	ACTION TO TAKE
<b>C1 CHECK SYSTEM FOR VACUUM LEAKS</b> <ul style="list-style-type: none"> <li>• Retrieve diagnostic trouble codes (DTCs) from the interface adapter assembly (IAA) module.</li> <li>• <b>Does DTC C1777 Vacuum Pressure Circuit Failure occur?</b></li> </ul>	Yes = GO to <a href="#">Pinpoint Test A.</a> No = GO to <b>C2.</b>
<b>C2 CHECK VACUUM LINE TO VACUUM LINE JOINT CONNECTION</b> <ul style="list-style-type: none"> <li>• With key ON, disconnect the vacuum line joint connection between the vacuum tee assembly and climate control vacuum reservoir and plug the vacuum line leading to the vacuum tee assembly.</li> <li>• Monitor the IAA module PID VACPRES for change in vacuum pressure after the vacuum pump shuts off.</li> <li>• <b>Does the vacuum level remain constant?</b></li> </ul>	Yes = RECONNECT the vacuum line joint connection. GO to <b>C3.</b> No = RECONNECT the vacuum line joint connection. GO to <b>C4.</b>
<b>C3 CHECK VACUUM LINE BETWEEN CLIMATE CONTROL VACUUM RESERVOIR AND VACUUM LINE JOINT CONNECTION</b> <ul style="list-style-type: none"> <li>• With key ON, disconnect the vacuum line to the climate control vacuum reservoir and plug the vacuum line.</li> <li>• Monitor the IAA module PID VACPRES for change in vacuum pressure after the vacuum pump shuts off.</li> <li>• <b>Does the vacuum level remain constant?</b></li> </ul>	Yes = PERFORM Climate Control Vacuum System Leak Test. REFER to <a href="#">Section 412-02.</a> No = REPLACE the vacuum line between the climate control vacuum reservoir and vacuum line joint connection.
<b>C4 CHECK VACUUM LINE BETWEEN VACUUM LINE JOINT CONNECTION AND VACUUM TEE ASSEMBLY</b> <ul style="list-style-type: none"> <li>• With key ON, disconnect the vacuum line leading to the vacuum line joint connection from the vacuum tee assembly and plug the vacuum tee assembly.</li> <li>• Monitor the IAA module PID VACPRES for change in vacuum pressure after the vacuum pump shuts off.</li> <li>• <b>Does the vacuum level remain constant?</b></li> </ul>	Yes = RECONNECT the vacuum line. GO to <b>C5.</b> No = REPLACE the vacuum line between the vacuum line joint connector and vacuum tee assembly.
<b>C5 CHECK BRAKE BOOSTER</b> <ul style="list-style-type: none"> <li>• With key ON, remove the check valve from the brake booster and plug the check valve.</li> <li>• Monitor the IAA module PID VACPRES for change in vacuum pressure after the vacuum pump shuts off.</li> <li>• <b>Does the vacuum level remain constant?</b></li> </ul>	Yes = REPLACE the brake booster. REFER to <b>Section 206-07 of the 2001 Ranger Workshop Manual.</b> No = GO to <b>C6.</b>
<b>C6 CHECK BRAKE BOOSTER CHECK VALVE</b> <ul style="list-style-type: none"> <li>• With key ON, remove the check valve from the vacuum hose and plug the hose.</li> <li>• Monitor the IAA PID module VACPRES for change in vacuum pressure after the vacuum pump shuts off.</li> <li>• <b>Does the vacuum level remain constant?</b></li> </ul>	Yes = REPLACE the brake booster check valve. No = GO to <b>C7.</b>
<b>C7 CHECK VACUUM TEE ASSEMBLY</b> <ul style="list-style-type: none"> <li>• With key ON, remove the brake booster vacuum hose from the vacuum tee assembly and plug the vacuum tee fitting.</li> <li>• Monitor the IAA module PID VACPRES for change in vacuum pressure after the vacuum pump shuts off.</li> <li>• <b>Does the vacuum level remain constant?</b></li> </ul>	Yes = REPLACE the brake booster vacuum hose. No = REPLACE the vacuum tee assembly. REFER to the procedure for the <a href="#">vacuum pressure sensor.</a>

**DIAGNOSIS AND TESTING (Continued)****PINPOINT TEST D: VACUUM PUMP EXHIBITS UNUSUAL OR EXCESSIVE NOISE**

TEST STEP	ACTION TO TAKE
<b>D1 CHECK VACUUM PUMP ISOLATION MOUNT</b> <ul style="list-style-type: none"> <li>• With key OFF, check for excessive movement of the vacuum pump housing within the isolation mount.</li> <li>• <b>Is there excessive movement?</b></li> </ul>	Yes = GO to <b>D3</b> . No = GO to <b>D2</b> .
<b>D2 CHECK VACUUM PUMP PERFORMANCE</b> <ul style="list-style-type: none"> <li>• With key OFF, disconnect the vacuum hose at the vacuum pump.</li> <li>• Depress the brake pedal until the pedal is hard to press.</li> <li>• Reconnect the vacuum hose to the vacuum pump.</li> <li>• With key ON, monitor the interface adapter assembly (IAA) module PID VACPRES and note the time it takes the vacuum pressure to reach 34 kPa (4.9 psi).</li> <li>• <b>Does the vacuum pressure reach 34 kPa (4.9 psi) in less than 18 seconds?</b></li> </ul>	Yes = System OK. No = REPLACE the vacuum pump.
<b>D3 CHECK TORQUE REQUIREMENTS FOR THE VACUUM PUMP BRACKET</b> <ul style="list-style-type: none"> <li>• Check the torque specifications for the vacuum pump bracket bolts. Refer to the Torque Specification Chart.</li> <li>• <b>Are the torque specifications correct?</b></li> </ul>	Yes = GO to <b>D4</b> . No = TIGHTEN the vacuum pump bracket bolt to the correct specifications.
<b>D4 CHECK FOR VACUUM PUMP INTERFERENCE</b> <ul style="list-style-type: none"> <li>• Grasp the vacuum pump and move it within the limits of the rubber isolator mounts and note any contact with surrounding components.</li> <li>• <b>Does the vacuum pump make contact with any surrounding components?</b></li> </ul>	Yes = INSTALL the vacuum pump correctly. No = GO to <b>D5</b> .
<b>D5 CHECK VACUUM PUMP RUBBER ISOLATOR MOUNTS</b> <ul style="list-style-type: none"> <li>• Remove the vacuum pump from the vehicle and inspect the rubber isolator mounts for cracks, fractures, or any other obvious damage.</li> <li>• <b>Are the rubber isolator mounts damaged?</b></li> </ul>	Yes = REPLACE the vacuum pump. No = REINSTALL the vacuum pump.

**REMOVAL AND INSTALLATION****Vacuum Pressure Sensor****Removal**

1. Disconnect the auxiliary battery ground cable.
2. Raise and support the vehicle. For additional information, refer to [Section 100-02](#).

## REMOVAL AND INSTALLATION (Continued)

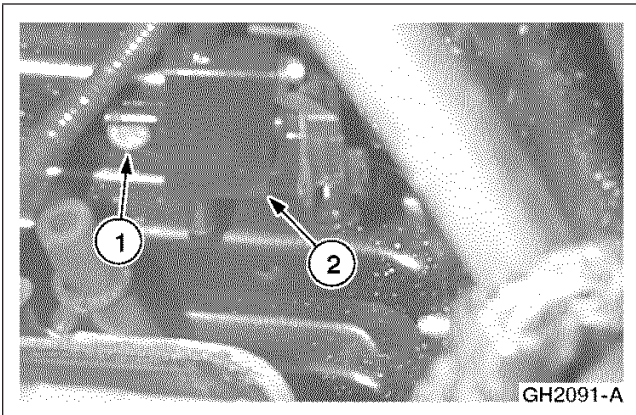
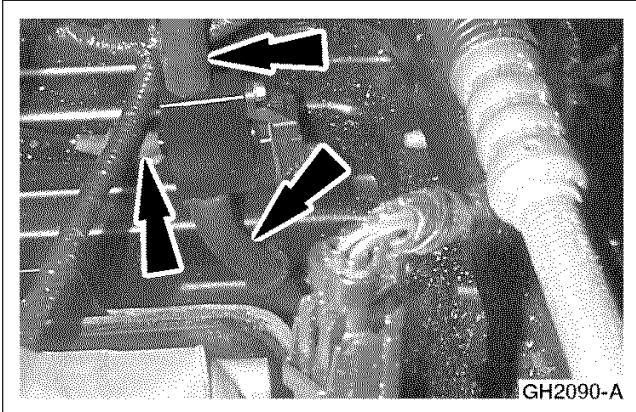
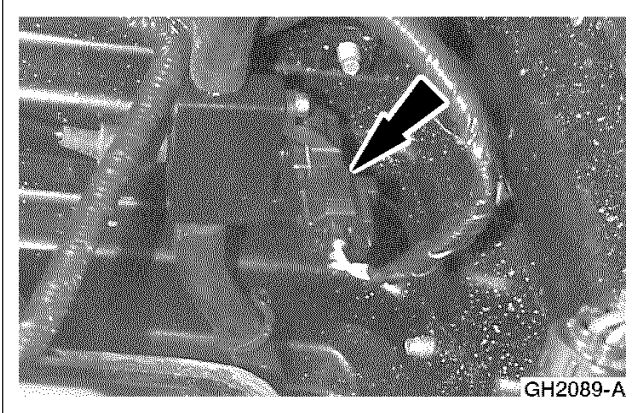

3. **NOTE:** The vacuum pressure sensor is located in the underhood compartment underneath the card table.

Disconnect the vacuum pressure sensor electrical connector.

4. Disconnect the vacuum pressure sensor vacuum lines.

5. Remove the vacuum pressure sensor.

- 1 Remove the bolt.
- 2 Remove the pressure sensor.

6. **NOTE:** If the vacuum tee is being replaced, this step is not necessary. A vacuum pressure sensor is included with the vacuum tee replacement part.

Separate the vacuum pressure sensor from the vacuum tee.

- Remove the two screws.

### Installation

1. To install, reverse the removal procedure.

## REMOVAL AND INSTALLATION (Continued)

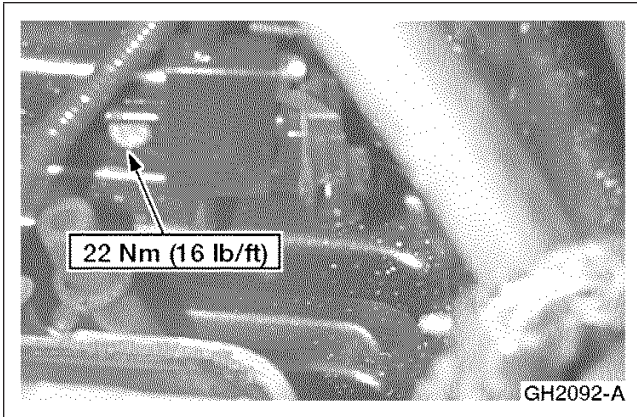

### Vacuum Pump

#### Removal

1. Disconnect the auxiliary battery ground cable.
2. Raise and support the vehicle. For additional information, refer to [Section 100-02](#).
3. Remove the vacuum pump.
  - 1 Disconnect the vacuum line.
  - 2 Disconnect the electrical connector.
  - 3 Remove the pump bracket bolts.
  - 4 Remove the pump.

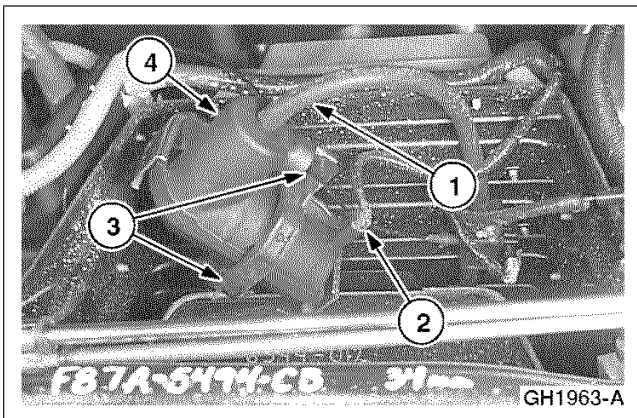

#### Installation

1. Install the vacuum pump.
  - 1 Position the vacuum pump.
  - 2 Install the pump bracket bolts.
  - 3 Connect the vacuum line.
  - 4 Connect the electrical connector.

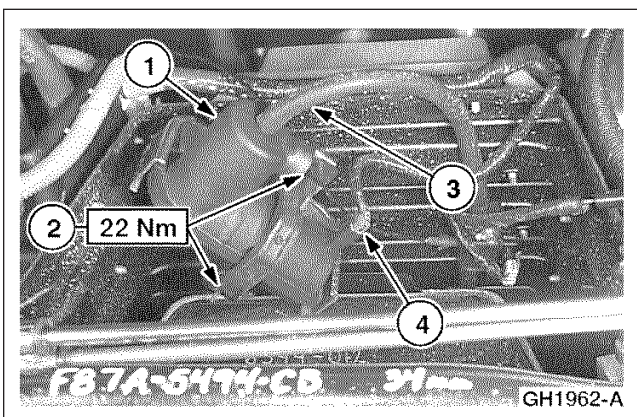

---

**REMOVAL AND INSTALLATION (Continued)**

2. Connect the traction battery. For additional information, refer to [Section 414-03A](#) or [Section 414-03B](#).



---

 Manual Table of Contents

## SECTION 206-09 Anti-Lock Control

VEHICLE APPLICATION: Ranger EV

CONTENTS	PAGE
<b>SPECIFICATIONS</b> .....	206-09-2
<b>DESCRIPTION AND OPERATION</b>	
Anti-Lock Brake and Regenerative Braking System .....	206-09-2
Hydraulic Control Unit .....	206-09-2
<b>DIAGNOSIS AND TESTING</b>	
Anti-Lock Control .....	206-09-3
Active Command Index .....	206-09-5
Diagnostic Trouble Code (DTC) Definition .....	206-09-3
Electrical Schematic .....	206-09-4
Inspection and Verification .....	206-09-4
Parameter Identification (PID) Index .....	206-09-4
Pinpoint Tests .....	206-09-6
Symptom Chart .....	206-09-5
<b>REMOVAL AND INSTALLATION</b>	
Anti-Lock Brake Control Module .....	206-09-13
Anti-Lock Brake Sensor —Front .....	206-09-15
Anti-Lock Brake Sensor —Rear .....	206-09-15
Hydraulic Control Unit .....	206-09-16

## SPECIFICATIONS

### Torque Specifications

Description	Nm	Lb-Ft	Lb-In
Anti-Lock Brake Control Module Screws	2	—	16
Anti-Lock Brake Sensor Bolt	6	—	54
Anti-Lock Brake Sensor Harness Bracket Bolt	12	—	107

(Continued)

### Torque Specifications

Description	Nm	Lb-Ft	Lb-In
Battery Ground Cable	6.2	—	53.5
Brake Line Fittings	18	13	—
Hydraulic Control Unit (HCU) Anti-Lock Brake Control Module Assembly Bracket Bolts	9	—	80

## DESCRIPTION AND OPERATION

### Anti-Lock Brake and Regenerative Braking System

The anti-lock brake system (ABS) on the Electric Ranger is a Teves Mark 20i-based system that uses four anti-lock brake sensors. A sensor mounted at each of the four wheels provides wheel speed information to the anti-lock brake control module, which operates the ABS to efficiently stop the vehicle.

The regenerative braking system recovers vehicle kinetic energy during deceleration to replace traction battery energy. A certain level of regenerative braking is commanded by releasing the accelerator pedal. Further regenerative braking is commanded by pressing the brake pedal. During deceleration, the motor/transaxle is turned by the vehicle's wheels. When the vehicle is operated in the economy (E) mode, the effects of regenerative braking are increased. Whenever the ABS is activated, regenerative braking is disabled until the ABS event is over and the accelerator pedal is pressed.

### Hydraulic Control Unit

The hydraulic control unit (HCU) uses six electric solenoids to control brake fluid flow to the front and rear wheels. The front wheels are on two separate circuits and the rear wheels are on a single circuit. The anti-lock brake control module bolts to the HCU and provides the electronic signals to the HCU to control solenoid operation. Wheel speed information is fed to the ABS module by anti-lock brake sensors. If the module senses that a wheel is about to lock up, the solenoid for that wheel will be activated to control braking.

## DIAGNOSIS AND TESTING

### Anti-Lock Control

#### Diagnostic Trouble Code (DTC) Definition

The following DTCs relate to the anti-lock brake system (ABS):

- DTC C1095 Hydraulic Pump Motor Circuit Failure
  - DTC C1095 is generated when the anti-lock brake control module detects that the pump motor cannot run when commanded to do so or is running erroneously. The anti-lock brake control module checks the pump operation at key ON. If the brake pedal is depressed, the test will be delayed until the brake pedal is released. This motor test occurs each time the vehicle is started or at the end of an ABS event. The motor will run during ABS events causing pedal pulsations.
- DTCs C1145, C1155, C1165, and C1175, Speed Sensor Input Circuit Failure
  - These DTCs are generated when the anti-lock brake control module detects an open or short to ground in the circuits to the anti-lock brake sensor, an open or shorted sensor coil, or an open or shorted trigger circuit in the anti-lock brake control module.
- DTCs C1233, C1234, C1235, and C1236, Anti-Lock Brake —Input Signal Missing
  - These DTCs are generated when the anti-lock brake control module detects a missing sensor signal causing unwarranted ABS cycling or an extended locked wheel behavior.
- DTC C1267 ABS Functions —Temporarily Disabled
  - DTC C1267 is generated when the anti-lock brake control module detects an internal failure.

- DTC B1342 ECU Is Defective
  - DTC C1267 is generated when the anti-lock brake control module detects an internal failure.
- DTC B1676 Battery Voltage Out of Range
  - DTC B1676 is generated when the anti-lock brake control module detects the battery voltage is less than 9 volts on the internal ignition RUN signal for more than 200 milliseconds with the vehicle speed greater than 20 km/h (12 mph) (operational) or any speed (self-test), or battery voltage is greater than 19 volts on the internal ignition RUN signal for more than 0.5 milliseconds. The DC/DC converts high-voltage to low voltage for various low voltage systems. Less than 10 volts may be present during this test and the DC/DC may not be on-line continuously. This DTC can be set from a DC/DC circuit that is failing intermittently.

The following DTCs relate to the traction inverter module (TIM) and anti-lock brake control module interface:

- DTC C1184 ABS System Is Not Operational
  - The anti-lock brake control module has a fault line which it uses to notify the traction inverter module (TIM) when an anti-lock brake system (ABS) fault occurs. The anti-lock brake control module outputs a 12 volt signal that it pulls low (0 volts) when it detects an ABS fault. This signal stays low until the concern has been corrected. The TIM generates DTC C1184 and disables regenerative braking during normal operation when it detects the ABS fault line is low. If DTC C1184 occurs, the malfunction indicator lamp (MIL), red brake warning indicator, and yellow ABS warning indicator are illuminated.

**DIAGNOSIS AND TESTING (Continued)**

- DTC U2015 Signal Link Fault (Non SCP)
  - The anti-lock brake control module has an active line that it uses to notify the traction inverter module (TIM) when an anti-lock brake system (ABS ) event occurs. The anti-lock brake control module outputs a zero volt signal that it pulls high (12 volts) when it detects an ABS event. This signal stays high during an ABS event. The TIM performs a power-on self-test (POST) for the ABS interface by monitoring the ABS fault line and ABS active line at key START. During the POST, the anti-lock brake control module pulses the ABS fault line by pulling it low (0 volts) and releasing it back to 12 volts, and pulses the ABS event line by pulling it high and releasing it back to zero volts. If the TIM does not detect either pulse, the TIM generates DTC U2015 and disables regenerative braking. If DTC U2015 occurs, the malfunction indicator lamp (MIL), red brake warning indicator, and yellow ABS warning indicator are illuminated.

**Electrical Schematic**

Refer to **Electrical and Vacuum Troubleshooting Manual, Cell 42, Anti-lock Brake System (ABS)** for schematic and connector information.

**Inspection and Verification**

Refer to [Section 100-07](#).

**Parameter Identification (PID) Index****Anti-Lock Brake Control Module Parameter Identification (PID) Index**

PID	Description	Expected Values
CONTABS	Number of Continuous DTCs on ABS	one count per bit
BOO_ABS	Brake Pedal Position Switch Input	ON, OFF
ABSLF_I	Left Front ABS Inlet Valve	ON, OFF
ABSRF_I	Right Front ABS Inlet Valve	ON, OFF
ABSR_I	Rear ABS Inlet Valve	ON, OFF
ABSLF_O	Left Front ABS Outlet Valve	ON, OFF
ABSRF_O	Right Front ABS Outlet Valve	ON, OFF
ABSR_O	Rear ABS Outlet Valve	ON, OFF
LF_WSPD	Left Front Wheel Speed	0-255 KPH
RF_WSPD	Right Front Wheel Speed	0-255 KPH
LR_WSPD	Left Rear Wheel Speed	0-255 KPH
RR_WSPD	Right Rear Wheel Speed	0-255 KPH

**Traction Inverter Module (TIM) Parameter Identification (PID) Index**

PID	Description	Expected Values
ABS_WI	ABS Warning Indicator Input Status	ENABLE/DISABLE
ABS_SIG	ABS Active Input Signal Status	ACTIVE/notACT

**DIAGNOSIS AND TESTING (Continued)****Active Command Index****Anti-Lock Brake Active Command Index**

<b>Active Command</b>	<b>Display</b>	<b>Action</b>
ABS Output Control	PMP Motor	ON, OFF
	LF Inlet	ON, OFF
	RF Inlet	ON, OFF
	R Inlet	ON, OFF
	LF Outlet	ON, OFF
	RF Outlet	ON, OFF
	R Outlet	ON, OFF
ABS Output Control II	ABS Active	ON, OFF

**Symptom Chart****Symptom Chart**

<b>Condition</b>	<b>Possible Sources</b>	<b>Action</b>
<ul style="list-style-type: none"> <li>DTC C1095 Hydraulic Pump Motor Circuit Failure (Continuous/On-Demand Test Mode)</li> </ul>	<ul style="list-style-type: none"> <li>Fuse.</li> <li>Circuit(s).</li> <li>Anti-lock brake control module.</li> <li>Hydraulic control unit (HCU).</li> </ul>	<ul style="list-style-type: none"> <li>GO to <a href="#">Pinpoint Test A.</a></li> </ul>
<ul style="list-style-type: none"> <li>DTC C1145 RF Speed Sensor Input Circuit Failure (Continuous/On-Demand Test Mode)</li> </ul>	<ul style="list-style-type: none"> <li>RF anti-lock brake sensor.</li> <li>Circuit(s).</li> <li>Anti-lock brake control module.</li> </ul>	<ul style="list-style-type: none"> <li>GO to <a href="#">Pinpoint Test B.</a></li> </ul>
<ul style="list-style-type: none"> <li>DTC C1155 LF Speed Sensor Input Circuit Failure (Continuous/On-Demand Test Mode)</li> </ul>	<ul style="list-style-type: none"> <li>LF anti-lock brake sensor.</li> <li>Circuit(s).</li> <li>Anti-lock brake control module.</li> </ul>	<ul style="list-style-type: none"> <li>GO to <a href="#">Pinpoint Test B.</a></li> </ul>
<ul style="list-style-type: none"> <li>DTC C1165 RR Speed Sensor Input Circuit Failure (Continuous/On-Demand Test Mode)</li> </ul>	<ul style="list-style-type: none"> <li>RR anti-lock brake sensor.</li> <li>Circuit(s).</li> <li>Anti-lock brake control module.</li> </ul>	<ul style="list-style-type: none"> <li>GO to <a href="#">Pinpoint Test B.</a></li> </ul>
<ul style="list-style-type: none"> <li>DTC C1175 LR Speed Sensor Input Circuit Failure (Continuous/On-Demand Test Mode)</li> </ul>	<ul style="list-style-type: none"> <li>LR anti-lock brake sensor.</li> <li>Circuit(s).</li> <li>Anti-lock brake control module.</li> </ul>	<ul style="list-style-type: none"> <li>GO to <a href="#">Pinpoint Test B.</a></li> </ul>
<ul style="list-style-type: none"> <li>DTC C1184 ABS System Is Not Operational (Continuous Test Mode)</li> </ul>	<ul style="list-style-type: none"> <li>ABS fault.</li> <li>Circuit(s).</li> <li>Traction inverter module (TIM).</li> <li>Anti-lock brake control module.</li> </ul>	<ul style="list-style-type: none"> <li>GO to <a href="#">Pinpoint Test C.</a></li> </ul>
<ul style="list-style-type: none"> <li>DTC C1233 LF Wheel Speed —Input Signal Missing (Continuous Test Mode)</li> </ul>	<ul style="list-style-type: none"> <li>Loose LF anti-lock brake sensor mounting.</li> <li>LF anti-lock brake sensor.</li> <li>Tone ring.</li> </ul>	<ul style="list-style-type: none"> <li>GO to <a href="#">Pinpoint Test D.</a></li> </ul>

**DIAGNOSIS AND TESTING (Continued)****Symptom Chart (Continued)**

<b>Condition</b>	<b>Possible Sources</b>	<b>Action</b>
<ul style="list-style-type: none"> <li>DTC C1234 RF Wheel Speed —Input Signal Missing (Continuous Test Mode)</li> </ul>	<ul style="list-style-type: none"> <li>Loose RF anti-lock brake sensor mounting.</li> <li>RF anti-lock brake sensor.</li> <li>Tone ring.</li> </ul>	<ul style="list-style-type: none"> <li>GO to <a href="#">Pinpoint Test D.</a></li> </ul>
<ul style="list-style-type: none"> <li>DTC C1235 RR Wheel Speed —Input Signal Missing (Continuous Test Mode)</li> </ul>	<ul style="list-style-type: none"> <li>Loose RR anti-lock brake sensor mounting.</li> <li>RR anti-lock brake sensor.</li> <li>Tone ring.</li> </ul>	<ul style="list-style-type: none"> <li>GO to <a href="#">Pinpoint Test D.</a></li> </ul>
<ul style="list-style-type: none"> <li>DTC C1236 LR Wheel Speed —Input Signal Missing (Continuous Test Mode)</li> </ul>	<ul style="list-style-type: none"> <li>Loose LR anti-lock brake sensor mounting.</li> <li>LR anti-lock brake sensor.</li> <li>Tone ring.</li> </ul>	<ul style="list-style-type: none"> <li>GO to <a href="#">Pinpoint Test D.</a></li> </ul>
<ul style="list-style-type: none"> <li>DTC C1267 ABS Functions —Temporarily Disabled (Continuous Test Mode)</li> </ul>	<ul style="list-style-type: none"> <li>Anti-lock brake control module.</li> </ul>	<ul style="list-style-type: none"> <li>REPLACE the anti-lock brake control module.</li> </ul>
<ul style="list-style-type: none"> <li>DTC B1342 ECU Is Defective (Continuous/On-Demand Test Mode)</li> </ul>	<ul style="list-style-type: none"> <li>Anti-lock brake control module.</li> </ul>	<ul style="list-style-type: none"> <li>REPLACE the anti-lock brake control module.</li> </ul>
<ul style="list-style-type: none"> <li>DTC B1676 Battery Voltage Out of Range (Continuous/On-Demand Test Mode)</li> </ul>	<ul style="list-style-type: none"> <li>Fuse.</li> <li>Circuit(s).</li> <li>Voltage supply out of range.</li> <li>DC/DC Inverter.</li> </ul>	<ul style="list-style-type: none"> <li>GO to <a href="#">Pinpoint Test E.</a></li> </ul>
<ul style="list-style-type: none"> <li>DTC U2015 Signal Link Fault (Non SCP) (Continuous Test Mode)</li> </ul>	<ul style="list-style-type: none"> <li>ABS fault.</li> <li>Circuit(s).</li> <li>Traction inverter module (TIM).</li> <li>Anti-lock brake control module.</li> </ul>	<ul style="list-style-type: none"> <li>GO to <a href="#">Pinpoint Test F.</a></li> </ul>
<ul style="list-style-type: none"> <li>No Communication With the Anti-Lock Brake Control Module</li> </ul>	<ul style="list-style-type: none"> <li>Fuse.</li> <li>Circuit.</li> <li>Anti-lock brake control module.</li> </ul>	<ul style="list-style-type: none"> <li>GO to <a href="#">Pinpoint Test G.</a></li> </ul>
<ul style="list-style-type: none"> <li>Loss of Sensor Signal During Vehicle Deceleration or Sensor Signal Drops Out at Low Speed</li> </ul>	<ul style="list-style-type: none"> <li>Tone ring.</li> <li>Sensor output is weak.</li> <li>Air gap.</li> <li>Anti-lock brake control module.</li> </ul>	<ul style="list-style-type: none"> <li>INSPECT both front wheel end tone rings and both rear wheel end tone rings.</li> <li>LF anti-lock brake sensor — <a href="#">GO to Pinpoint Test D.</a></li> <li>RF anti-lock brake sensor — <a href="#">GO to Pinpoint Test D.</a></li> <li>LR anti-lock brake sensor — <a href="#">GO to Pinpoint Test D.</a></li> <li>RR anti-lock brake sensor — <a href="#">GO to Pinpoint Test D.</a></li> </ul>

**Pinpoint Tests****Special Tool(s)**

104-Pin Breakout Box (BOB) 418-049 (014-00950) or equivalent
BCM/TIM Breakout Box (BOB) Adapter Cable 418-F212
BCM/TIM Breakout Box (BOB) Overlay 418-F220

**DIAGNOSIS AND TESTING (Continued)****PINPOINT TEST A: DTC C1095 HYDRAULIC PUMP MOTOR CIRCUIT FAILURE**

<b>TEST STEP</b>	<b>ACTION TO TAKE</b>
<b>A1 CHECK FUSE AND POWER TO ANTI-LOCK BRAKE CONTROL MODULE</b> <ul style="list-style-type: none"> <li>• Check 60A fuse 4 in the electric vehicle power distribution box (EVPDB).</li> <li>• With key OFF, disconnect anti-lock brake control module C154.</li> <li>• With key ON, measure the voltage between pin 9 (Y/LG wire) on the anti-lock brake control module C154 and ground. (V &gt; 10 volts)</li> <li>• <b>Is everything OK?</b></li> </ul>	Yes = GO to <b>A2</b> . No = REPAIR as necessary.
<b>A2 CHECK PUMP MOTOR FOR CONTINUOUS OPERATION</b> <ul style="list-style-type: none"> <li>• With key ON, listen to the pump motor.</li> <li>• <b>Does the pump motor run continuously?</b></li> </ul>	Yes = REPLACE the anti-lock brake control module. No = GO to <b>A3</b> .
<b>A3 CHECK PUMP MOTOR OPERATION</b> <ul style="list-style-type: none"> <li>• Enter the active command mode ABS OUTPUT CONTROL and set the active command PMP MOTOR to ON.</li> <li>• <b>Does the pump motor operate?</b></li> </ul>	Yes = REPLACE the Anti-lock Braking System (ABS)/Hydraulic Control Unit (HCU) assembly. No = GO to <b>A4</b> .
<b>A4 CHECK CONNECTION OF PUMP MOTOR CONNECTOR</b> <ul style="list-style-type: none"> <li>• Verify the pump motor C1944 is securely seated.</li> <li>• <b>Is the pump motor C1944 securely seated?</b></li> </ul>	Yes = GO to <b>A5</b> . No = CONNECT the pump motor C1944 securely and RETEST.
<b>A5 CHECK PUMP MOTOR CONNECTOR FOR CORROSION OR DAMAGE</b> <ul style="list-style-type: none"> <li>• With key OFF, disconnect pump motor C1944 and check the pump motor C1944 for corrosion or other obvious damage.</li> <li>• <b>Is the pump motor C1944 OK?</b></li> </ul>	Yes = GO to <b>A6</b> . No = CLEAN/REPAIR as necessary and RETEST.
<b>A6 CHECK PUMP MOTOR</b> <ul style="list-style-type: none"> <li>• With key OFF, connect 12 volts and ground to the terminals of the pump motor.</li> <li>• <b>Does the pump motor operate?</b></li> </ul>	Yes = REPLACE the anti-lock brake control module. No = REPLACE the hydraulic control unit (HCU).

**PINPOINT TEST B: DTCs C1145, C1155, C1165, AND C1175, SPEED SENSOR INPUT CIRCUIT FAILURE**

<b>TEST STEP</b>	<b>ACTION TO TAKE</b>
<b>B1 CHECK RESISTANCE OF ANTI-LOCK BRAKE SENSOR</b> <ul style="list-style-type: none"> <li>• With key OFF, disconnect the anti-lock brake sensor connector in question and measure the resistance between the two terminals of the anti-lock brake sensor.</li> <li>• <b>Is the resistance between 800 and 1400 ohms?</b></li> </ul>	Yes = GO to <b>B2</b> . No = REPLACE the anti-lock brake sensor.
<b>B2 CHECK ANTI-LOCK BRAKE SENSOR FOR SHORT TO GROUND</b> <ul style="list-style-type: none"> <li>• With key OFF, measure the resistance between either terminal of the anti-lock brake sensor and ground.</li> <li>• <b>Is the resistance greater than 10,000 ohms?</b></li> </ul>	Yes = GO to <b>B3</b> . No = REPLACE the anti-lock brake sensor.
<b>B3 CHECK WIRING TO ANTI-LOCK BRAKE SENSOR FOR OPEN</b>	

(Continued)

**DIAGNOSIS AND TESTING (Continued)****PINPOINT TEST B: DTCs C1145, C1155, C1165, AND C1175, SPEED SENSOR INPUT CIRCUIT FAILURE**

TEST STEP	ACTION TO TAKE
<ul style="list-style-type: none"> <li>• With key OFF, reconnect anti-lock brake sensor, disconnect anti-lock brake control module C154, and measure the resistance between the indicated wires on the anti-lock brake control module C154:  <b>RF Anti-Lock Brake Sensor</b>  —Pin 3 (Y/BK wire) and pin 4 (Y/R wire)  <b>LF Anti-Lock Brake Sensor</b>  —Pin 17 (T/BK wire) and pin 18 (T/O wire)  <b>RR Anti-Lock Brake Sensor</b>  —Pin 6 (R/PK wire) and pin 7 (PK/BK wire)  <b>LR Anti-Lock Brake Sensor</b>  —Pin 21 (LG/BK wire) and pin 22 (LG/R wire)</li> <li>• <b>Is the resistance between 800 and 1400 ohms?</b></li> </ul>	<p>Yes = GO to <b>B5</b>.</p> <p>No = GO to <b>B4</b>.</p>
<p><b>B4 CHECK WIRE TO ANTI-LOCK BRAKE SENSOR FOR OPEN</b></p> <p><b>RF Anti-Lock Brake Sensor:</b></p> <ul style="list-style-type: none"> <li>• With key OFF, disconnect RF anti-lock brake sensor C158 and measure the resistance of the Y/BK wire between pin 3 on the anti-lock brake control module C154 and the RF anti-lock brake sensor C158.</li> </ul> <p><b>LF Anti-Lock Brake Sensor:</b></p> <ul style="list-style-type: none"> <li>• With key OFF, disconnect LF anti-lock brake sensor C151 and measure the resistance of the T/BK wire between pin 17 on the anti-lock brake control module C154 and the LF anti-lock brake sensor C151.</li> </ul> <p><b>RR Anti-Lock Brake Sensor:</b></p> <ul style="list-style-type: none"> <li>• With key OFF, disconnect RR anti-lock brake sensor C4995 and measure the resistance of the PK/BK wire between pin 7 on the anti-lock brake control module C154 and the RR anti-lock brake sensor C4995.</li> </ul> <p><b>LR Anti-Lock Brake Sensor:</b></p> <ul style="list-style-type: none"> <li>• With key OFF, disconnect LR anti-lock brake sensor C4994 and measure the resistance of the LG/BK wire between pin 21 on the anti-lock brake control module C154 and the LR anti-lock brake sensor C4994.</li> </ul> <li>• <b>Is the resistance less than 5 ohms?</b></li>	<p>Yes = REPAIR the Y/R wire (RF), T/O wire (LF), R/PK wire (RR), or LG/R wire (LR).</p> <p>No = REPAIR the Y/BK wire (RF), T/BK wire (LF), PK/BK wire (RR), or LG/BK wire (LR).</p>
<p><b>B5 CHECK WIRING TO ANTI-LOCK BRAKE SENSOR FOR SHORT TO GROUND</b></p> <ul style="list-style-type: none"> <li>• With key OFF, measure the resistance between the indicated wires on the anti-lock brake control module C154 and ground:  <b>RF Anti-Lock Brake Sensor:</b>  —Pin 3 (Y/BK wire)  <b>LF Anti-lock Brake Sensor:</b>  —Pin 17 (T/BK wire)  <b>RR Anti-lock Brake Sensor:</b>  —Pin 6 (R/PK wire)  <b>LR Anti-lock Brake Sensor:</b>  —Pin 21 (LG/BK wire)</li> <li>• <b>Is the resistance greater than 10,000 ohms?</b></li> </ul>	<p>Yes = GO to <b>B7</b>.</p> <p>No = GO to <b>B6</b>.</p>
<p><b>B6 CHECK WIRE TO ANTI-LOCK BRAKE SENSOR FOR SHORT TO GROUND</b></p> <p><b>RF Anti-Lock Brake Sensor:</b></p> <ul style="list-style-type: none"> <li>• With key OFF, disconnect RF anti-lock brake sensor C158 and measure the resistance between pin 3 (Y/BK wire) on anti-lock brake control module C154 and ground.</li> </ul> <p><b>LF Anti-Lock Brake Sensor:</b></p>	<p>Yes = REPAIR the Y/R wire (RF), T/O wire (LF), R/PK wire (RR), or LG/R wire (LR).</p>

(Continued)



**DIAGNOSIS AND TESTING (Continued)****PINPOINT TEST B: DTCs C1145, C1155, C1165, AND C1175, SPEED SENSOR INPUT CIRCUIT FAILURE**

TEST STEP	ACTION TO TAKE
<ul style="list-style-type: none"> <li>With key OFF, disconnect LF anti-lock brake sensor C151 and measure the resistance between pin 17 (T/BK wire) on anti-lock brake control module C154 and ground.</li> </ul> <p><b>RR Anti-Lock Brake Sensor:</b></p> <ul style="list-style-type: none"> <li>With key OFF, disconnect RR anti-lock brake sensor C4995 and measure the resistance between pin 7 (PK/BK wire) on anti-lock brake control module C154 and ground.</li> </ul> <p><b>LR Anti-Lock Brake Sensor:</b></p> <ul style="list-style-type: none"> <li>With key OFF, disconnect LR anti-lock brake sensor C4994 and measure the resistance between pin 21 (LG/BK wire) on anti-lock brake control module C154 and ground.</li> <li><b>Is the resistance greater than 10,000 ohms?</b></li> </ul>	No = REPAIR the Y/BK wire (RF), T/BK wire (LF), PK/BK wire (RR), or LG/BK wire (LR).
<p><b>B7 VERIFY CONCERN IS RESOLVED</b></p> <ul style="list-style-type: none"> <li>Reconnect anti-lock brake control module C154.</li> <li>Clear the ABS DTCs.</li> <li>Drive the vehicle.</li> <li>Retrieve ABS DTCs.</li> <li><b>Does the same DTC occur?</b></li> </ul>	Yes = REPLACE the Anti-lock Braking System (ABS)/Hydraulic Control Unit (HCV) assembly.  No = Concern is intermittent. INSPECT all connections for corrosion, pin pushout, and terminal contact. REPAIR as necessary.

**PINPOINT TEST C: DTC C1184 ABS SYSTEM IS NOT OPERATIONAL**

TEST STEP	ACTION TO TAKE
<p><b>C1 CHECK ANTI-LOCK BRAKE SYSTEM (ABS) FOR DIAGNOSTIC TROUBLE CODES (DTCs)</b></p> <p><b>NOTE:</b> DTC C1184 ABS System Is Not Operational occurs if the ignition key is cycled OFF/ON too fast. Do not carry out any pinpoint tests related to the ABS unless the yellow ABS warning indicator is illuminated and ABS DTCs occur.</p> <ul style="list-style-type: none"> <li>Retrieve ABS DTCs.</li> <li><b>Did any ABS DTCs occur?</b></li> </ul>	Yes = REFER to <a href="#">Symptom Chart</a> .  No = GO to C2.
<p><b>C2 CHECK TRACTION INVERTER MODULE (TIM) FOR DTCs</b></p> <ul style="list-style-type: none"> <li>Clear the TIM DTCs.</li> <li>Turn the ignition key to the START position and retrieve DTCs from the TIM.</li> <li><b>Does DTC U2015 Signal Link Fault (Non SCP) occur?</b></li> </ul>	Yes = GO to <a href="#">Pinpoint Test F</a> . No = System OK. CHECK for intermittent wiring connections.

**PINPOINT TEST D: DTCs C1233, C1234, C1235, AND C1236, WHEEL SPEED —INPUT SIGNAL MISSING**

TEST STEP	ACTION TO TAKE
<p><b>D1 CHECK MOUNTING OF ANTI-LOCK BRAKE SENSOR</b></p> <ul style="list-style-type: none"> <li>Inspect the anti-lock brake sensor in question for loose mounting.</li> <li><b>Is the anti-lock brake sensor secure?</b></li> </ul>	Yes = GO to D2. No = TIGHTEN the anti-lock brake sensor to specification and RETEST.
<p><b>D2 CHECK TONE RING</b></p>	

(Continued)

**DIAGNOSIS AND TESTING (Continued)****PINPOINT TEST D: DTCs C1233, C1234, C1235, AND C1236, WHEEL SPEED —INPUT SIGNAL MISSING**

TEST STEP	ACTION TO TAKE
<ul style="list-style-type: none"> <li>•  <b>CAUTION:</b> Examine the tone ring carefully with good light. Failure to catch issues with the tone ring will lead to unnecessary component replacement. Inspect the tone ring for corrosion, nicks, missing teeth, or other obvious damage.</li> <li>• <b>Is the tone ring damaged?</b></li> </ul>	Yes = REPLACE the tone ring.  No = GO to <b>D3</b> .
<b>D3 CHECK AIR GAP AT ANTI-LOCK BRAKE SENSOR</b> <ul style="list-style-type: none"> <li>• Measure the air gap between the anti-lock brake sensor and the tone ring teeth. Repeat in at least two more wheel positions. Verify the value as indicated below:  <b>Front Anti-Lock Brake Sensors</b>            —0.43 mm (0.017 in) to 1.85 mm (0.073 in)  <b>Rear Anti-Lock Brake Sensors</b>            —0.097 mm (0.004 in) to 1.62 mm (0.064 in)</li> <li>• <b>Is the air gap correct and consistent for all wheel positions?</b></li> </ul>	Yes = REPLACE the anti-lock brake sensor.  No = REPLACE the tone ring.

**PINPOINT TEST E: DTC B1676 BATTERY VOLTAGE OUT OF RANGE**

TEST STEP	ACTION TO TAKE
<b>E1 CHECK FUSE AND POWER TO ANTI-LOCK BRAKE CONTROL MODULE</b> <ul style="list-style-type: none"> <li>•  <b>CAUTION:</b> If the malfunction indicator lamp (MIL) is illuminated, retrieve diagnostic trouble codes (DTCs) from the Interface Adapter Assembly (IAA) module before carrying out this pinpoint test. If IAA module DTCs exist, refer to the Interface Adapter Assembly (IAA) Module Diagnostic Trouble Code (DTC) Index in Section 100-07. Failure to follow this caution may lead to misdiagnosis and unnecessary component replacement. Check the MIL before proceeding.</li> <li>• Check 30A fuse 3 in the electric vehicle power distribution box (EVPDB).</li> <li>• With key OFF, disconnect anti-lock brake control module C154.</li> <li>• With key ON, measure the voltage between pin 25 (R wire) on the anti-lock brake control module C154 and ground. (V &gt; 10 volts)</li> <li>• <b>Is everything OK?</b></li> </ul>	Yes = GO to <b>E2</b> .  No = REPAIR as necessary.
<b>E2 VERIFY CONCERN IS RESOLVED</b> <ul style="list-style-type: none"> <li>• Reconnect anti-lock brake control module C154.</li> <li>• Clear the ABS DTCs.</li> <li>• Retrieve ABS DTCs.</li> <li>• <b>Does the same DTC occur?</b></li> </ul>	Yes = REPLACE the Anti-lock Braking System (ABS)/Hydraulic Control Unit (HCU) assembly.  No = Concern is intermittent. INSPECT all connections for corrosion, pin pushout, and terminal contact. REPAIR as necessary.

**DIAGNOSIS AND TESTING (Continued)****PINPOINT TEST F: DTC U2015 SIGNAL LINK FAULT (NON SCP)**

TEST STEP	ACTION TO TAKE
<p><b>F1 CHECK ANTI-LOCK BRAKE SYSTEM (ABS) FOR DIAGNOSTIC TROUBLE CODES (DTCs)</b></p> <p><b>NOTE:</b> The red brake warning indicator and malfunction indicator lamp (MIL) illuminate and DTC U2015 Signal Link Fault (Non SCP) occurs if the ignition key is cycled OFF/ON before the anti-lock brake control module completes its pump check. If this occurs, clear traction inverter module (TIM) DTCs, turn the ignition key to the ON position, and wait for the completion of the ABS pump check. Continue with this pinpoint test only if TIM DTC U2015 occurs after the completion of the ABS pump check.</p> <ul style="list-style-type: none"> <li>Retrieve ABS DTCs.</li> <li><b>Did any ABS DTCs occur?</b></li> </ul>	<p>Yes = REFER to <a href="#">Symptom Chart</a>.</p> <p>No = GO to <b>F2</b>.</p>
<p><b>F2 CHECK ABS ACTIVE LINE INPUT SIGNAL STATUS</b></p> <ul style="list-style-type: none"> <li>Monitor TIM PID ABS__SIG.</li> <li>Turn the ignition key to the START position.</li> <li><b>Does the ABS__SIG PID indicate ACTIVE and return to notACT?</b></li> </ul>	<p>Yes = GO to <b>F10</b>.</p> <p>No = If ABS__SIG PID indicates ACTIVE at all times, GO to <b>F3</b>.</p> <p>If ABS__SIG PID indicates notACT at all times, GO to <b>F8</b>.</p>
<p><b>F3 CHECK FUSE</b></p> <ul style="list-style-type: none"> <li>Check 5A fuse 24 in the electric vehicle power distribution box (EVPDB).</li> <li><b>Is the fuse OK?</b></li> </ul>	<p>Yes = GO to <b>F4</b>.</p> <p>No = REPLACE the fuse.</p>
<p><b>F4 CHECK CIRCUITS 491 (O/LB) (ABS ACTIVE LINE) FOR OPEN(S)</b></p> <ul style="list-style-type: none"> <li>Connect 104-Pin Breakout Box (BOB) to TIM C4998, C4999 using the BCM/TIM BOB Adapter and Overlay; leave the TIM disconnected.</li> <li>With key OFF, remove 5A fuse 24 from the EVPDB and measure the resistance of the O/LB wire between fuse 24 connector and BOB pin B6.</li> <li>With key OFF, disconnect pump motor C1944 and measure the resistance of the O/LB wire between fuse 24 connector and pump motor C1944.</li> <li><b>Are the resistances less than 5 ohms?</b></li> </ul>	<p>Yes = GO to <b>F5</b>.</p> <p>No = REPAIR the wire(s) in question.</p>
<p><b>F5 CHECK TIM FOR OPEN</b></p> <ul style="list-style-type: none"> <li>With key OFF, disconnect the BOB from TIM C4998, C4999; leave BOB connected to the TIM.</li> <li>With key OFF, measure the resistance between BOB pin B6 and ground (BOB pin A29).</li> <li><b>Is the resistance greater than 80,000 ohms?</b></li> </ul>	<p>Yes = REPLACE the TIM. REFER to <a href="#">Section 303-14</a>.</p> <p>No = GO to <b>F6</b>.</p>
<p><b>F6 CHECK CIRCUITS 491 (O/LB) (ABS ACTIVE LINE) FOR SHORT(S) TO POWER</b></p> <ul style="list-style-type: none"> <li>With key OFF, disconnect BOB from TIM; connect BOB to TIM C4998, C4999.</li> <li>With key ON, measure the voltage between BOB pin B6 and ground (BOB pin A29).</li> <li>With key ON, measure the voltage between the O/LB wire on pump motor C1944 and ground.</li> <li><b>Are any of the voltages greater than 0 volts?</b></li> </ul>	<p>Yes = REPAIR the wire(s) in question.</p> <p>No = GO to <b>F7</b>.</p>
<p><b>F7 CHECK TIM FOR SHORT TO POWER</b></p> <ul style="list-style-type: none"> <li>With key OFF, connect BOB to TIM; leave BOB connected to TIM C4998, C4999.</li> </ul>	<p>Yes = REPLACE the TIM. REFER to <a href="#">Section 303-14</a>.</p>

(Continued)

**DIAGNOSIS AND TESTING (Continued)****PINPOINT TEST F: DTC U2015 SIGNAL LINK FAULT (NON SCP)**

TEST STEP	ACTION TO TAKE
<ul style="list-style-type: none"> <li>With key ON, measure the voltage between BOB pin B6 and ground (BOB pin A29).</li> <li><b>Is the voltage greater than 0 volts?</b></li> </ul>	No = REPLACE the anti-lock brake control module.
<b>F8 CHECK CIRCUITS 491 (O/LB) (ABS ACTIVE LINE) FOR SHORT(S) TO GROUND</b> <ul style="list-style-type: none"> <li>Connect 104-Pin Breakout Box (BOB) to TIM C4998, C4999 using the BCM/TIM BOB Adapter and Overlay; leave the TIM disconnected.</li> <li>With key OFF, remove 5A fuse 24 from the EVPDB and measure the resistance between BOB pin B6 and ground (BOB pin A29).</li> <li>With key OFF, disconnect pump motor C1944 and measure the resistance between the O/LB wire on pump motor C1944 and ground.</li> <li><b>Are the resistances greater than 10,000 ohms?</b></li> </ul>	Yes = GO to <b>F9</b> . No = REPAIR the wire(s) in question.
<b>F9 CHECK TIM FOR SHORT TO GROUND</b> <ul style="list-style-type: none"> <li>With key OFF, connect BOB to TIM; leave BOB connected to TIM C4998, C4999.</li> <li>With key OFF, disconnect anti-lock brake control module and measure the resistance between BOB pin B6 and ground (BOB pin A29).</li> <li><b>Is the resistance less than 5 ohms?</b></li> </ul>	Yes = REPLACE the TIM. REFER to <a href="#">Section 303-14</a> . No = REPLACE the Anti-lock Braking System (ABS)/Hydraulic Control Unit (HCV) assembly.
<b>F10 CHECK ABS WARNING INDICATOR INPUT STATUS</b> <ul style="list-style-type: none"> <li>Monitor TIM PID ABS__WI.</li> <li><b>Does the ABS__WI PID indicate ENABLE?</b></li> </ul>	Yes = GO to <b>F11</b> . No = GO to <b>F13</b> .
<b>F11 CHECK CIRCUITS 224 (T/W)/603 (DG) (ABS FAULT LINE) FOR SHORT TO GROUND</b> <ul style="list-style-type: none"> <li>Connect breakout box (BOB) to TIM C4998 and C4999 using the BCM/TIM BOB Adapter and Overlay; leave TIM disconnected.</li> <li>With key OFF, disconnect anti-lock brake control module C154, instrument cluster C216 and measure the resistance between BOB pin B1 and ground (BOB pin A29).</li> <li><b>Is the resistance greater than 10,000 ohms?</b></li> </ul>	Yes = GO to <b>F12</b> . No = REPAIR the T/W or DG wire.
<b>F12 CHECK ANTI-LOCK BRAKE CONTROL MODULE</b> <ul style="list-style-type: none"> <li>With key OFF, reconnect anti-lock brake control module C154 and measure the resistance between BOB pin B1 and ground (BOB pin A29).</li> <li><b>Is the resistance less than 5 ohms?</b></li> </ul>	Yes = REPLACE the Anti-lock Braking System (ABS)/Hydraulic Control Unit (HCV) assembly. No = REPLACE the TIM. REFER to <a href="#">Section 303-14</a> .
<b>F13 CHECK CIRCUITS 224 (T/W)/603 (DG) (ABS FAULT LINE) FOR OPEN</b> <ul style="list-style-type: none"> <li>Connect breakout box (BOB) to TIM C4998 and C4999 using the TIM BOB adapter and overlay; leave TIM disconnected.</li> <li>With key OFF, disconnect anti-lock brake control module C154 and measure the resistance between pin 16 on the anti-lock brake control module C154 and BOB pin B1.</li> <li><b>Is the resistance less than 5 ohms?</b></li> </ul>	Yes = GO to <b>F14</b> . No = REPAIR the T/W or DG wire.
<b>F14 CHECK CIRCUITS 224 (T/W)/603 (DG) (ABS FAULT LINE) FOR SHORT TO POWER</b> <ul style="list-style-type: none"> <li>With key ON, measure the voltage between BOB pin B1 and ground (BOB pin A29).</li> <li><b>Is the voltage greater than 0 volts?</b></li> </ul>	Yes = REPAIR the T/W or DG wire. No = REPLACE the TIM. REFER to <a href="#">Section 303-14</a> .

**DIAGNOSIS AND TESTING (Continued)****PINPOINT TEST G: NO COMMUNICATION WITH THE ANTI-LOCK BRAKE CONTROL MODULE**

TEST STEP	ACTION TO TAKE
<p><b>G1 CHECK FUSE, IGNITION POWER, AND GROUND TO ANTI-LOCK BRAKE CONTROL MODULE</b></p> <ul style="list-style-type: none"> <li>• Check 10A fuse 14 in the I/P fuse panel.</li> <li>• With key OFF, disconnect anti-lock brake control module C154 and measure the resistance between pin 8 (BK wire), pin 24 (BK wire) on the anti-lock brake control module C154 and ground. (R &lt; 5 ohms)</li> <li>• With key ON, measure the voltage between pin 25 (R wire) on the anti-lock brake control module C154 and ground. (V &gt; 10 volts)</li> <li>• <b>Is everything OK?</b></li> </ul>	<p>Yes = REFER to <a href="#">Section 418-00</a>. No = REPAIR as necessary.</p>

**REMOVAL AND INSTALLATION****Anti-Lock Brake Control Module****Removal**

1. Disconnect the auxiliary battery ground cable.
2. Disconnect the upper hydraulic control unit (HCU) electrical connector.
  - 1 Pull up on the connector latch.
  - 2 Disconnect the electrical connector.
3. Disconnect the lower HCU electrical connector.

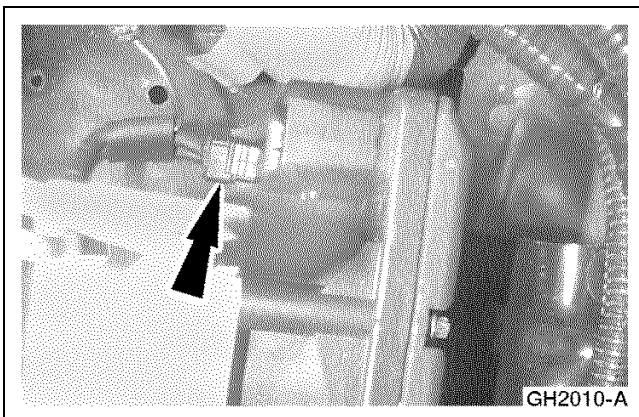
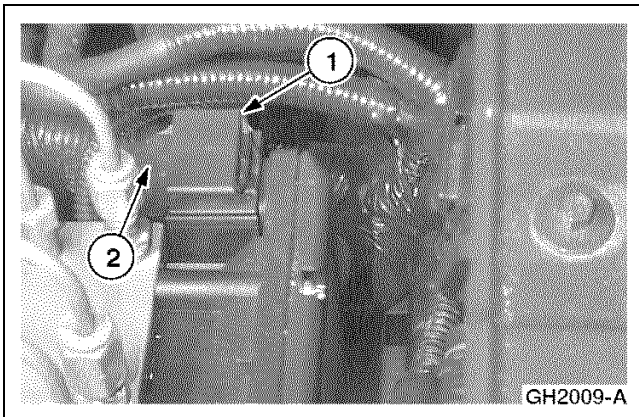

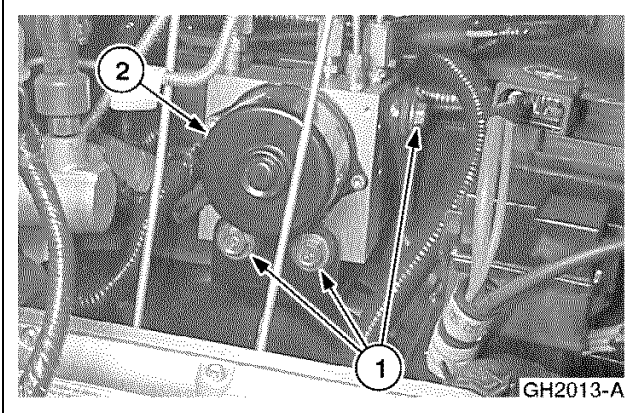
**REMOVAL AND INSTALLATION (Continued)**

4. Position the HCU/anti-lock brake system (ABS) assembly.
  - 1 Remove the HCU bracket bolts.
  - 2 Position the ABS assembly aside to gain access to the anti-lock brake control module.

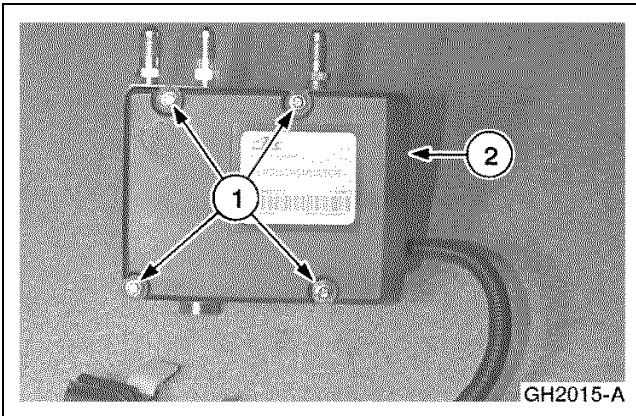

5. **NOTE:** The ABS assembly is shown removed from the vehicle for clarity.  
Remove the anti-lock brake control module.
  - 1 Remove the screws.
  - 2 Remove the module.

**Installation**

1. To install, reverse the removal procedure.

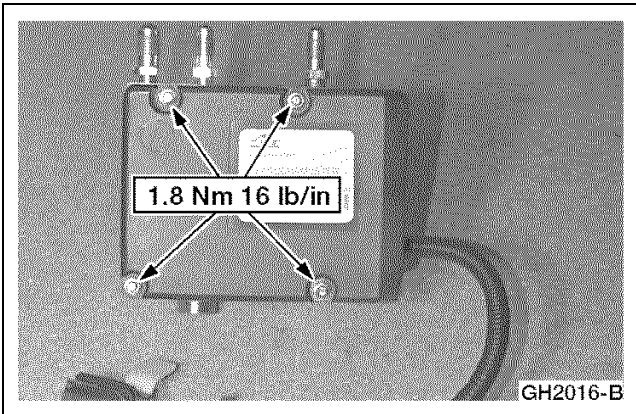

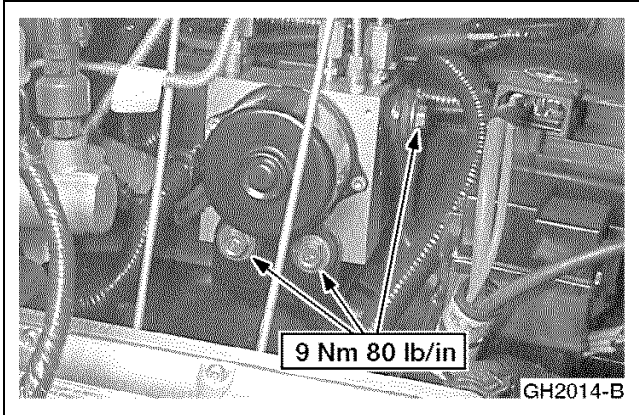
**REMOVAL AND INSTALLATION (Continued)****Anti-Lock Brake Sensor —Front****Removal**

1. Refer to **Section 206-09** of the **2001 Ranger Workshop Manual**.

**Anti-Lock Brake Sensor —Rear****Removal and Installation**

1. Raise and support the vehicle. Refer to [Section 100-02](#).
2. Remove the bolt and the anti-lock brake sensor.

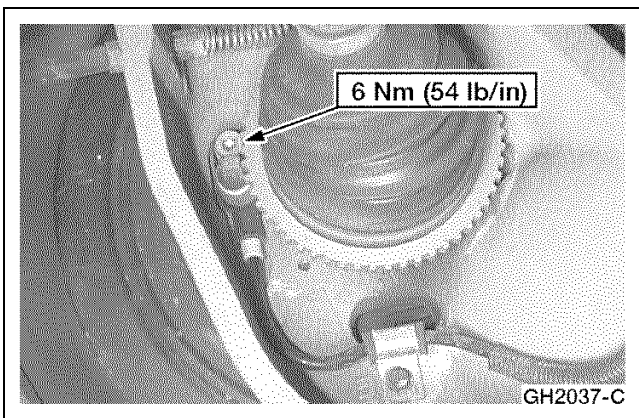

## REMOVAL AND INSTALLATION (Continued)

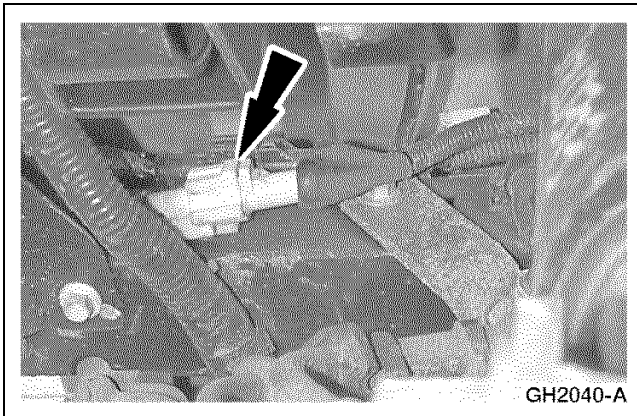
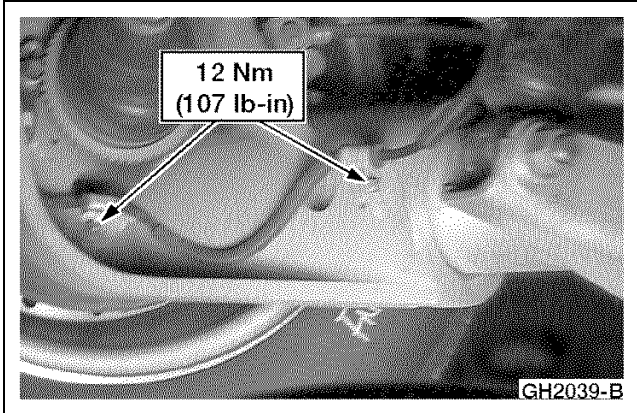

3. Remove the harness bracket bolts.
4. Disconnect the sensor electrical connector and remove the anti-lock brake sensor.
5. To install, reverse the removal procedure.

## Hydraulic Control Unit

### Removal

**⚠ WARNING:** Brake fluid contains polyglycol ethers and polyglycols. Avoid contact with eyes. Wash hands thoroughly after handling. If brake fluid contacts eyes, flush eyes with running water for 15 minutes. Get medical attention if irritation persists. If taken internally, drink water and induce vomiting. Get medical attention immediately.

**⚠ CAUTION:** Brake fluid is harmful to painted and plastic surfaces. If brake fluid is spilled onto a painted or plastic surface, immediately wash it with water.

1. Disconnect the auxiliary battery ground cable.

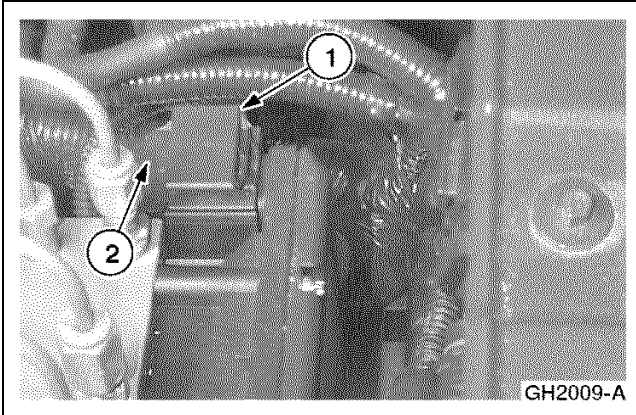

**REMOVAL AND INSTALLATION (Continued)**

2. Disconnect the upper hydraulic control unit (HCU) electrical connector.
  - 1 Pull up on the connector latch.
  - 2 Disconnect the electrical connector.

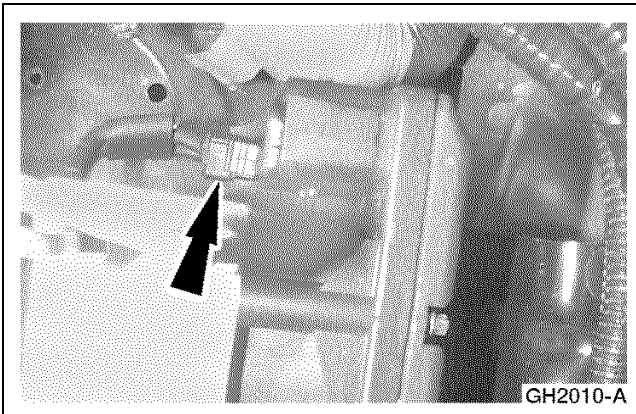

3. Disconnect the lower HCU electrical connector.

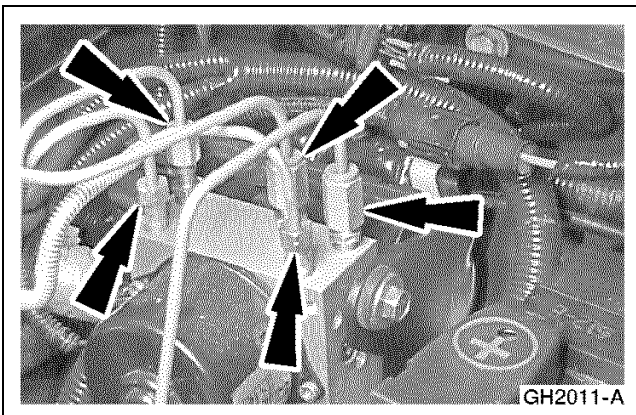

4. Disconnect the brake line fittings.

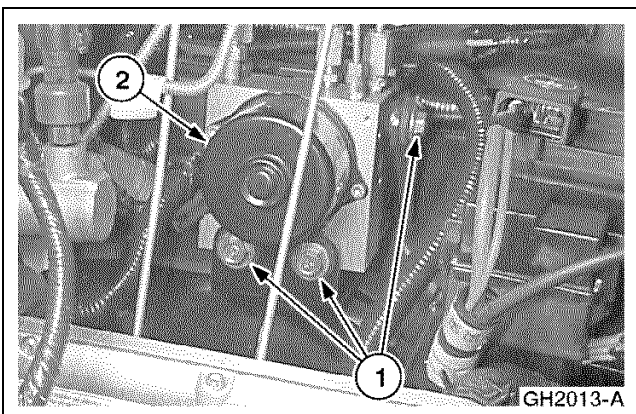

5. Remove the HCU/anti-lock brake control module assembly.
  - 1 Remove the bracket bolts.
  - 2 Remove the assembly.

## REMOVAL AND INSTALLATION (Continued)

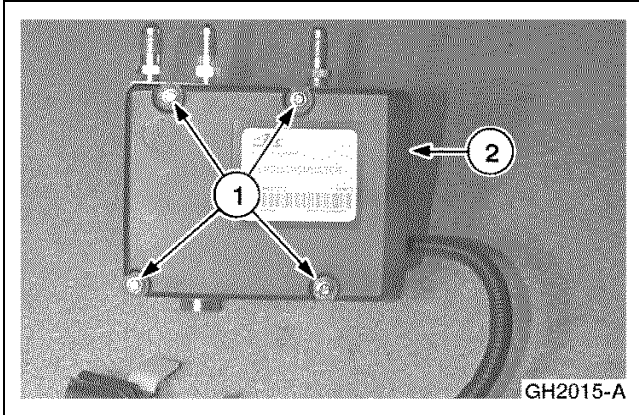

6. Remove the anti-lock brake control module.
  - 1 Remove the screws.
  - 2 Remove the module.

## Installation

1. To install, reverse the removal procedure.
  - After installation, bleed the brake system. Refer to **Section 206-09** of the **2001 Ranger Workshop Manual**.

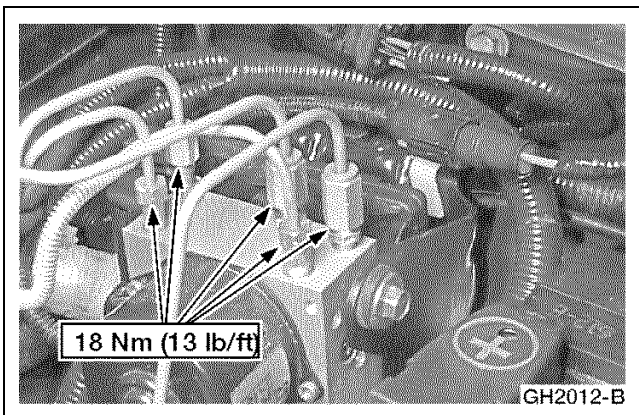
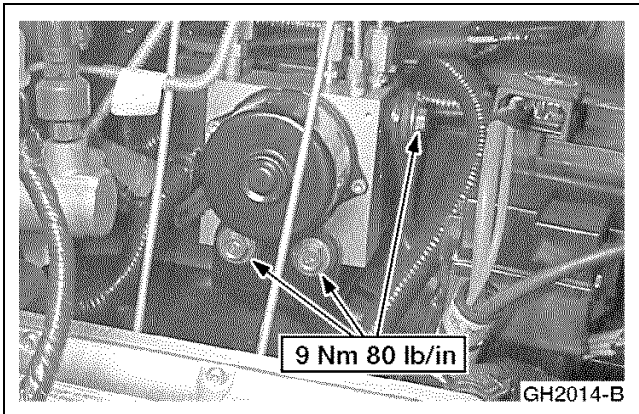
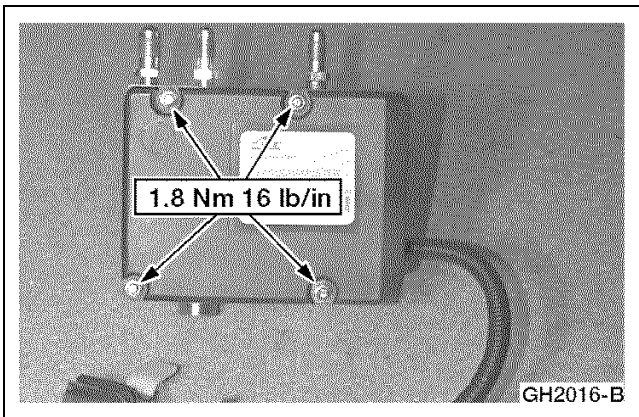

---

 Manual Table of Contents

## SECTION 211-02 Power Steering

VEHICLE APPLICATION: Ranger EV

CONTENTS	PAGE
<b>SPECIFICATIONS</b> .....	211-02-2
<b>DESCRIPTION AND OPERATION</b>	
Power Steering .....	211-02-2
Power Steering —Postal Ranger EV .....	211-02-2
<b>DIAGNOSIS AND TESTING</b>	
Power Steering .....	211-02-3
Electrical Schematic .....	211-02-3
Inspection and Verification .....	211-02-3
Pinpoint Tests .....	211-02-4
Symptom Chart .....	211-02-4
<b>REMOVAL AND INSTALLATION</b>	
Power Steering Assembly .....	211-02-9
Power Steering Gear .....	211-02-10
Power Steering Gear —Postal Ranger EV .....	211-02-13
Power Steering Pump Hoses —Pressure Hose .....	211-02-14
Power Steering Pump Hoses —Pressure Hose - Postal Ranger EV .....	211-02-16
Power Steering Pump Hoses —Return Hose .....	211-02-18
Power Steering Pump Hoses —Return Hose - Postal Ranger EV .....	211-02-19
Power Steering Pump Hoses —Supply Hose .....	211-02-21
Power Steering Pump Hoses —Supply Hose - Postal Ranger EV .....	211-02-22
Power Steering Reservoir.....	211-02-23
Power Steering Reservoir —Postal Ranger EV .....	211-02-24
Steering Wheel Sensor.....	211-02-24

## SPECIFICATIONS

### Torque Specifications

Description	Nm	Lb-Ft	Lb-In
A/C Compressor Bolts	22.5	16.5	—
A/C Compressor Bracket Bolts	22.5	16.5	—
Line Clamp Bolt	12	—	107
Pressure Hose to Pump Fitting	40	29.5	—
Pressure Hose to Steering Gear Fitting	37	27	—

(Continued)

### Torque Specifications

Description	Nm	Lb-Ft	Lb-In
Power Steering Assembly Nuts	22	16	—
Power Steering Reservoir Screws	6	—	53.5
Return Hose to Steering Gear Fitting	37	27	—
Steering Wheel Sensor Bolts	2.5	—	22

## DESCRIPTION AND OPERATION

### Power Steering

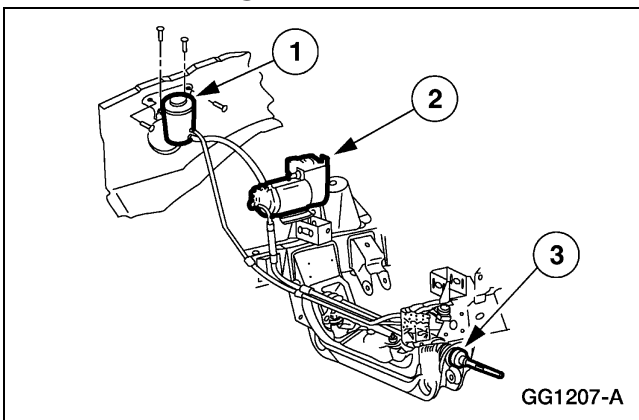

Item	Description
1	Power Steering Reservoir
2	Power Steering Assembly
3	Steering Gear

The power steering system on the Electric Ranger is composed of a steering gear and steering linkage from the Ranger 4x4. Pressure for the power steering is supplied by an electrically operated pump. A steering wheel sensor is mounted on the column to provide turning information to the power steering pump. An electronic controller receives the steering wheel sensor input and vehicle speed information from the traction inverter module (TIM). Based upon this information, the electronic controller varies the pump output to meet current vehicle needs.

The power steering pump can be heard when the vehicle is turned on and the steering wheel is turned while the vehicle is stationary. This will cause the pump to operate at full output. Once the steering wheel is released, the pump will return to normal. At temperatures lower than -6.7°C (20°F), the pump may take up to 30 seconds before it is able to provide full assist.

### Power Steering —Postal Ranger EV

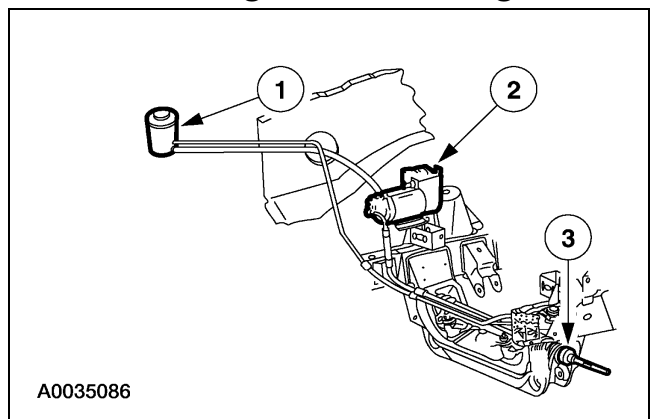

Item	Description
1	Power steering reservoir
2	Power steering assembly
3	Steering gear

---

**DESCRIPTION AND OPERATION (Continued)**

The power steering system on the Postal Ranger EV is composed of a steering gear and steering linkage from the Explorer. Pressure for the power steering is supplied by an electrically operated pump. A steering wheel sensor is mounted on the column to provide turning information to the power steering pump. An electronic controller receives the steering wheel sensor input and vehicle speed information from the traction inverter module (TIM). Based upon this information, the electronic controller varies the pump output to meet current vehicle needs.

The power steering pump can be heard when the vehicle is turned on and the steering wheel is turned while the vehicle is stationary. This will cause the pump to operate at full output. Once the steering wheel is released, the pump will return to normal. At temperatures lower than  $-6.7^{\circ}\text{C}$  ( $20^{\circ}\text{F}$ ), the pump may take up to 30 seconds before it is able to provide full assist.

**DIAGNOSIS AND TESTING****Power Steering****Diagnostic Trouble Code (DTC) Definition**

The following DTC relates to the power steering system:

- DTC C1778 Power Steering Failure
  - The power steering assembly has a fault line that it uses to notify the interface adapter assembly (IAA) module when a power steering system fault occurs. The power steering assembly outputs a 12-volt signal over the fault line when there is no fault and pulls it low (0 volts) when it detects a fault. The IAA module generates DTC C1778 if it detects the power steering fault line is low for more than 30 seconds with the power steering assembly enabled. The signal stays low until the concern has been corrected.

**Electrical Schematic**

Refer to **Electrical and Vacuum Troubleshooting Manual, Cell 43, Electronic Power Steering** for schematic and connector information.

**Inspection and Verification**

Refer to [Section 100-07](#).

**DIAGNOSIS AND TESTING (Continued)**

**Symptom Chart**

**Symptom Chart**

Condition	Possible Sources	Action
<ul style="list-style-type: none"> <li>DTC C1778 Power Steering Failure</li> </ul>	<ul style="list-style-type: none"> <li>Circuit(s).</li> <li>Interface adapter assembly (IAA) module.</li> <li>Power steering assembly.</li> <li>High-voltage fuse.</li> <li>High-voltage power distribution box (HVPDB).</li> </ul>	<ul style="list-style-type: none"> <li>GO to Pinpoint Test A.</li> </ul>
<ul style="list-style-type: none"> <li>No Power Steering Assist</li> </ul>	<ul style="list-style-type: none"> <li>Circuit(s).</li> <li>Interface adapter assembly (IAA) module.</li> <li>Power steering assembly.</li> <li>High-voltage fuse.</li> <li>High-voltage power distribution box (HVPDB).</li> </ul>	<ul style="list-style-type: none"> <li>GO to Pinpoint Test A.</li> </ul>
<ul style="list-style-type: none"> <li>More Than Usual Steering Effort Required to Turn Steering Wheel (Power Steering Pump Speed Does Not Increase While Turning the Steering Wheel)</li> </ul>	<ul style="list-style-type: none"> <li>Power steering fluid level.</li> <li>Tire pressure.</li> <li>Steering alignment.</li> <li>Steering gear.</li> <li>Power steering assembly.</li> <li>Circuit(s).</li> <li>Steering wheel sensor.</li> </ul>	<ul style="list-style-type: none"> <li>GO to Pinpoint Test B.</li> </ul>
<ul style="list-style-type: none"> <li>Steering Effort Easier Than Normal at High Speeds</li> </ul>	<ul style="list-style-type: none"> <li>Steering alignment.</li> <li>Steering gear.</li> <li>Power steering assembly.</li> <li>Circuit(s).</li> </ul>	<ul style="list-style-type: none"> <li>GO to Pinpoint Test C.</li> </ul>
<ul style="list-style-type: none"> <li>Steering Wheel Shudder</li> </ul>	<ul style="list-style-type: none"> <li>Power steering fluid level.</li> <li>Air in system.</li> </ul>	<ul style="list-style-type: none"> <li>GO to Pinpoint Test D.</li> </ul>

**Pinpoint Tests**

**Special Tool(s)**

104-Pin Breakout Box (BOB) 418-049 (014-00950) or equivalent
Vacuum Tester 014-R1054 or equivalent
High Voltage Insulated Safety Gloves 100-F036 or equivalent
Face Shield 100-F035 or equivalent

**PINPOINT TEST A: DTC C1778 POWER STEERING FAILURE**

TEST STEP	ACTION TO TAKE
<b>A1 CHECK FOR MULTIPLE AUXILIARY LOAD FAILURE</b> <ul style="list-style-type: none"> <li>With key ON, measure the voltage of the auxiliary battery.</li> <li>Is the voltage greater than 13 volts?</li> </ul>	Yes = GO to A2. No = REFER to Multiple Auxiliary Load Failure Diagnosis in <a href="#">Section 414-03A</a> or <a href="#">Section 414-03B</a> .
<b>A2 VERIFY SYMPTOM</b>	



(Continued)

**DIAGNOSIS AND TESTING (Continued)****PINPOINT TEST A: DTC C1778 POWER STEERING FAILURE**

TEST STEP	ACTION TO TAKE
<p><b>NOTE:</b> Before proceeding, verify the power control station is not plugged into the vehicle and the power steering fluid level is OK.</p> <ul style="list-style-type: none"> <li>With key ON, rotate the steering wheel and note the steering effort.</li> <li><b>Is the steering wheel difficult to turn?</b></li> </ul>	<p>Yes = GO to <b>A6</b>.</p> <p>No = GO to <b>A3</b>.</p>
<p><b>A3 CHECK POWER STEERING FAULT STATUS</b></p> <ul style="list-style-type: none"> <li>With key ON, monitor the interface adapter assembly (IAA) module PID VAPSFLT.</li> <li><b>Does the VAPSFLT PID indicate YES?</b></li> </ul>	<p>Yes = GO to <b>A4</b>.</p> <p>No = VERIFY power steering system for normal operation.</p>
<p><b>A4 CHECK CIRCUIT 3022 (R/Y) FOR OPEN</b></p> <ul style="list-style-type: none"> <li>Connect 104-Pin Breakout Box (BOB) to IAA module C1945; leave IAA module disconnected.</li> <li>With key OFF, disconnect power steering assembly C1992 and measure the resistance of the R/Y wire between pin 13 on the power steering assembly C1992 and BOB pin 44.</li> <li><b>Is the resistance less than 5 ohms?</b></li> </ul>	<p>Yes = GO to <b>A5</b>.</p> <p>No = REPAIR the R/Y wire.</p>
<p><b>A5 CHECK CIRCUIT 3022 (R/Y) FOR SHORT TO GROUND</b></p> <ul style="list-style-type: none"> <li>With key OFF, measure the resistance between BOB pin 44 and ground (BOB pin 80).</li> <li><b>Is the resistance greater than 10,000 ohms?</b></li> </ul>	<p>Yes = GO to <b>A6</b>.</p> <p>No = REPAIR the R/Y wire.</p>
<p><b>A6 CHECK AUXILIARY CONTACTOR RELAY STATUS</b></p> <p><b>NOTE:</b> The BOB must be connected to the IAA module and IAA module C1945 to carry out this test step.</p> <ul style="list-style-type: none"> <li>With key OFF, reconnect power steering assembly C1992 (if disconnected) and connect the 104-Pin Breakout Box (BOB) to the IAA module and IAA module C1945.</li> <li>With key ON, monitor the interface adapter assembly (IAA) module PID AUX__HVC.</li> <li><b>Does the AUX__HVC PID indicate CLOSED?</b></li> </ul>	<p>Yes = GO to <b>A7</b>.</p> <p>No = CARRY OUT pinpoint test for IAA DTC C1862 Contactor Circuit Failure. REFER to Auxiliary Contactor Relay Control in <a href="#">Section 414-03A</a> or <a href="#">Section 414-03B</a>.</p>
<p><b>A7 CHECK POWER STEERING OPERATION</b></p> <ul style="list-style-type: none"> <li>Enter the IAA module active command mode AUXILIARY SYSTEM CONTROL and set the active commands SUPPT SLI to YES and PWR STEER to ON.</li> <li><b>Does the power steering pump operate?</b></li> </ul>	<p>Yes = System OK. CHECK for intermittent wiring connections.</p> <p>No = GO to <b>A8</b>.</p>
<p><b>A8 CHECK IAA MODULE POWER STEERING ENABLE SIGNAL</b></p> <ul style="list-style-type: none"> <li>Enter the IAA module active command mode AUXILIARY SYSTEM CONTROL and set the active commands SUPPT SLI to YES and PWR STEER to ON.</li> <li>With key ON, measure the voltage between BOB pin 99 and ground (BOB pin 80).</li> <li><b>Is the voltage greater than 10 volts?</b></li> </ul>	<p>Yes = GO to <b>A9</b>.</p> <p>No = GO to <b>A10</b>.</p>
<p><b>A9 CHECK CIRCUIT 3023 (BK/O) FOR SHORT TO POWER</b></p> <ul style="list-style-type: none"> <li>With key OFF, disconnect the IAA module from the BOB; leave BOB connected to IAA module C1945.</li> <li>With key OFF, disconnect power steering assembly C1992.</li> <li>With key ON, measure the voltage between BOB pin 99 and ground (BOB pin 80).</li> <li><b>Is the voltage greater than 0 volts?</b></li> </ul>	<p>Yes = REPAIR the BK/O wire.</p> <p>No = REPLACE the IAA module. REFER to Section 412-04.</p>

(Continued)

**DIAGNOSIS AND TESTING (Continued)****PINPOINT TEST A: DTC C1778 POWER STEERING FAILURE**

TEST STEP	ACTION TO TAKE
<b>A10 CHECK CIRCUIT 3023 (BK/O) FOR OPEN</b> <ul style="list-style-type: none"> <li>With key OFF, disconnect power steering assembly C1992 and measure the resistance of the BK/O wire between pin 17 on the power steering assembly C1992 and BOB pin 99.</li> <li><b>Is the resistance less than 5 ohms?</b></li> </ul>	Yes = GO to <b>A11</b> . No = REPAIR the BK/O wire.
<b>A11 CHECK LOW VOLTAGE POWER TO POWER STEERING ASSEMBLY</b> <ul style="list-style-type: none"> <li>With key ON, measure the voltage between pin 10 (LB/PK wire), pin 21 (LB/PK wire) on the power steering assembly C1992 and ground.</li> <li><b>Are the voltages greater than 10 volts?</b></li> </ul>	Yes = GO to <b>A12</b> . No = REPAIR the LB/PK wire(s) in question.
<b>A12 CHECK HIGH VOLTAGE POSITIVE BUS TO POWER STEERING ASSEMBLY FOR OPEN</b> <ul style="list-style-type: none"> <li>Disconnect the 12-volt auxiliary battery negative cable.</li> </ul> <p> <b>WARNING: The following test steps contain high-voltage procedures. High-voltage insulated safety gloves and face shield must be worn when carrying out the following steps. Do not attempt to check for high-voltage power at the power steering assembly high-voltage connector. The close proximity of the connector pins may cause an electrical arc. Failure to follow this warning may result in severe personal injury or death.</b></p> <ul style="list-style-type: none"> <li>Disconnect power steering assembly high-voltage C1895.</li> <li>Disconnect high-voltage auxiliary load in-line C1935 on the traction battery support tray.</li> <li>Measure the resistance between circuit 3140 (BK wire) on power steering assembly C1895F and circuit 3132 (Y wire) on high-voltage auxiliary load in-line C1935M.</li> <li><b>Is the resistance less than 5 ohms?</b></li> </ul>	Yes = REPLACE the power steering assembly. No = GO to <b>A13</b> .
<b>A13 CHECK HIGH-VOLTAGE FUSE</b> <p><b>NOTE:</b> If the 10A fuse is open, DO NOT replace the fuse until the cause of the short is found and repaired. Replacing the fuse prior to repairing the short will cause contactor failure.</p> <ul style="list-style-type: none"> <li>Disconnect all high-voltage power distribution box (HVPDB) high-voltage connectors.</li> <li>Measure the resistance of the 10A PWR STR fuse.</li> <li><b>Is the resistance greater than 1,000 ohms?</b></li> </ul>	Yes = REPLACE the 10A PWR STR fuse. GO to <b>A14</b> . No = REPLACE the HVPDB. REFER to <a href="#">Section 414-03A</a> or <a href="#">Section 414-03B</a> .
<b>A14 CHECK POWER STEERING ASSEMBLY FOR CAPACITOR DISCHARGE FAILURE</b> <p> <b>WARNING: Carefully probe the terminals of the power steering assembly. The power steering assembly contains high-voltage capacitors that can retain high voltage if there is a capacitor discharge failure. Shorting the probes together may cause an electrical arc.</b></p> <ul style="list-style-type: none"> <li>Measure the voltage between circuit 3140 (BK wire) terminal and circuit 3141 (W wire) terminal on power steering assembly C1895M.</li> <li><b>Is the voltage greater than 0 volts?</b></li> </ul>	Yes = REPLACE the power steering assembly. No = GO to <b>A15</b> .
<b>A15 CHECK POWER STEERING ASSEMBLY FOR SHORT</b>	

(Continued)



**DIAGNOSIS AND TESTING (Continued)****PINPOINT TEST A: DTC C1778 POWER STEERING FAILURE**

TEST STEP	ACTION TO TAKE
<ul style="list-style-type: none"> <li>Measure the resistance between circuit 3140 (BK wire) terminal and circuit 3141 (W wire) terminal on power steering assembly C1895M.</li> <li><b>Is the resistance less than 10 ohms?</b></li> </ul>	Yes = REPLACE the power steering assembly. No = GO to <b>A16</b> .
<b>A16 CHECK HVPDB FOR SHORT</b> <ul style="list-style-type: none"> <li>Measure the resistance between circuit 3140 (BK wire) and circuit 3141 (W wire) on power steering assembly C1895F.</li> <li><b>Is the resistance greater than 10,000 ohms?</b></li> </ul>	Yes = GO to <b>A17</b> . No = REPLACE the HVPDB. REFER to <a href="#">Section 414-03A</a> or <a href="#">Section 414-03B</a> .
<b>A17 CHECK SYSTEM</b> <ul style="list-style-type: none"> <li>With key OFF, reconnect all component connectors that were disconnected.</li> <li>Reconnect the 12-volt auxiliary battery negative cable.</li> <li>With key ON, turn the steering wheel from lock-to-lock.</li> <li><b>Does the 10A PWR STR high-voltage fuse fail again?</b></li> </ul>	Yes = REPLACE the power steering assembly. No = System OK.

**PINPOINT TEST B: MORE THAN USUAL STEERING EFFORT REQUIRED TO TURN STEERING WHEEL (POWER STEERING PUMP SPEED DOES NOT INCREASE WHILE TURNING THE STEERING WHEEL)**

TEST STEP	ACTION TO TAKE
<b>B1 CHECK POWER STEERING PUMP OPERATION</b> <p><b>NOTE:</b> Carry out the following steps with the hood raised. The speed of the power steering pump should increase when the steering wheel is turned and return to a slower speed after the steering wheel is released.</p> <ul style="list-style-type: none"> <li>With key ON, turn the steering wheel 90 degrees while listening to the speed of the power steering pump.</li> <li><b>Does the power steering pump speed increase?</b></li> </ul>	Yes = CHECK the power steering fluid level and tire pressures. If necessary, FILL to the appropriate level. If OK, CHECK the steering alignment and steering gear. REPAIR as necessary. No = GO to <b>B2</b> .
<b>B2 CHECK STEERING WHEEL SENSOR SIGNALS</b> <ul style="list-style-type: none"> <li>With key OFF, disconnect power steering assembly C1992.</li> <li>With key ON, measure the voltage between pin 6 (BR wire), pin 7 (R wire) on power steering assembly C1992 and ground while turning the steering wheel from left to right and right to left.</li> <li><b>Do the voltages fluctuate between 0 and 5 volts?</b></li> </ul>	Yes = REPLACE the power steering assembly. No = GO to <b>B3</b> .
<b>B3 CHECK POWER TO STEERING WHEEL SENSOR</b> <ul style="list-style-type: none"> <li>With key OFF, disconnect steering wheel sensor C2990.</li> <li>With key ON, measure the voltage between pin 4 (LB/PK wire) on steering wheel sensor C2990 and ground.</li> <li><b>Is the voltage greater than 10 volts?</b></li> </ul>	Yes = GO to <b>B4</b> . No = REPAIR the LB/PK wire.
<b>B4 CHECK CIRCUITS 3226 (BK/LG), 3227 (R), AND 3228 (BR) FOR OPEN(S)</b> <ul style="list-style-type: none"> <li>With key OFF, measure the resistance of the BK/LG wire between pin 1 on steering wheel sensor C2990 and pin 5 on power steering assembly C1992.</li> </ul>	Yes = GO to <b>B5</b> .

(Continued)

**DIAGNOSIS AND TESTING (Continued)****PINPOINT TEST B: MORE THAN USUAL STEERING EFFORT REQUIRED TO TURN STEERING WHEEL (POWER STEERING PUMP SPEED DOES NOT INCREASE WHILE TURNING THE STEERING WHEEL)**

TEST STEP	ACTION TO TAKE
<ul style="list-style-type: none"> <li>With key OFF, measure the resistance of the R wire between pin 2 on steering wheel sensor C2990 and pin 7 on power steering assembly C1992.</li> <li>With key OFF, measure the resistance of the BR wire between pin 3 on steering wheel sensor C2990 and pin 6 on power steering assembly C1992.</li> <li><b>Are the resistances less than 5 ohms?</b></li> </ul>	No = REPAIR the wire(s) in question.
<b>B5 CHECK CIRCUITS 3227 (R) AND 3228 (BR) FOR SHORT(S) TO GROUND</b> <ul style="list-style-type: none"> <li>With key OFF, measure the resistance between pin 6 (BR wire), pin 7 (R wire) on power steering assembly C1992 and ground.</li> <li><b>Are the resistances greater than 10,000 ohms?</b></li> </ul>	Yes = GO to <b>B6</b> . No = REPAIR the wire(s) in question.
<b>B6 CHECK CIRCUITS 3227 (R) AND 3228 (BR) FOR SHORT(S) TO POWER</b> <ul style="list-style-type: none"> <li>With key ON, measure the voltage between pin 6 (BR wire), pin 7 (R wire) on power steering assembly C1992 and ground.</li> <li><b>Are any of the voltages greater than 0 volts?</b></li> </ul>	Yes = REPAIR the wire(s) in question. No = REPLACE the steering wheel sensor.

**PINPOINT TEST C: STEERING EFFORT EASIER THAN NORMAL AT HIGH SPEEDS**

TEST STEP	ACTION TO TAKE
<b>C1 CHECK POWER STEERING PUMP OPERATION</b> <p><b>NOTE:</b> Carry out the following steps with the hood raised. The speed of the power steering pump should increase when the active command is sent by New Generation STAR (NGS) Tester.</p> <ul style="list-style-type: none"> <li>Enter the traction inverter module (TIM) active command mode SPEEDOMETER CONTROL and set the active command SPDOMETER to 20%.</li> <li><b>Does the power steering pump speed increase?</b></li> </ul>	Yes = CHECK the steering alignment and steering gear. REPAIR as necessary. No = GO to <b>C2</b> .
<b>C2 CHECK VEHICLE SPEED SENSOR (VSS) SIGNALS</b> <ul style="list-style-type: none"> <li>With key OFF, disconnect power steering assembly C1992.</li> <li>With TIM active command SPDOMETER set at 20%, measure the frequency between pin 15 (GY/BK wire) on power steering assembly C1992 and ground.</li> <li><b>Is the frequency between 0 and 8,000 Hz?</b></li> </ul>	Yes = REPLACE the power steering assembly. No = REPAIR the GY/BK wire between power steering assembly C1992 and TIM C4998.

**PINPOINT TEST D: STEERING WHEEL SHUDDER**

TEST STEP	ACTION TO TAKE
<b>D1 CHECK POWER STEERING FLUID</b> <ul style="list-style-type: none"> <li>Check power steering fluid level.</li> <li><b>Is the power steering fluid level OK?</b></li> </ul>	Yes = GO to <b>B2</b> . No = CHECK for hydraulic leaks. REPAIR as necessary. FILL power steering reservoir to correct level.
<b>D2 VERIFY STEERING WHEEL SHUDDER</b>	

(Continued)

## DIAGNOSIS AND TESTING (Continued)

### PINPOINT TEST D: STEERING WHEEL SHUDDER

TEST STEP	ACTION TO TAKE
<ul style="list-style-type: none"> <li>With vehicle parked and key ON, rotate the steering wheel from lock-to-lock.</li> </ul>	Yes = REMOVE power steering reservoir cap and use Vacuum Tester to purge air from the power steering system while rotating the steering wheel from lock-to-lock, or ROTATE steering wheel from lock-to-lock until shudder stops.
<ul style="list-style-type: none"> <li>Does steering wheel shudder?</li> </ul>	No = System OK.

## REMOVAL AND INSTALLATION

### Power Steering Assembly

#### Removal

1. Disconnect the traction battery auxiliary lead high-voltage connector. Refer to [Section 414-03A](#) or [Section 414-03B](#).
2. Disconnect the power steering assembly electrical connectors.
3. Disconnect the power steering assembly pump lines.
  - Clamp the reservoir hose to prevent fluid loss.

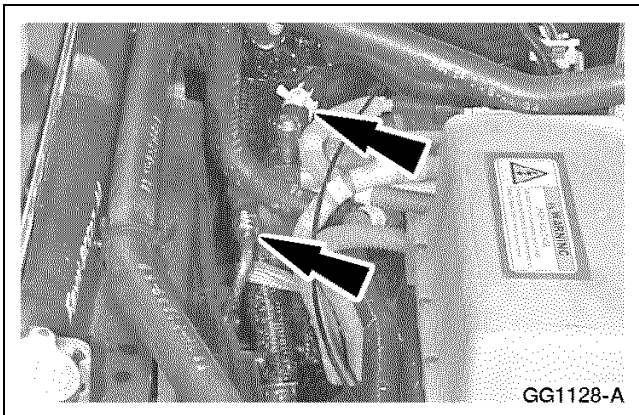
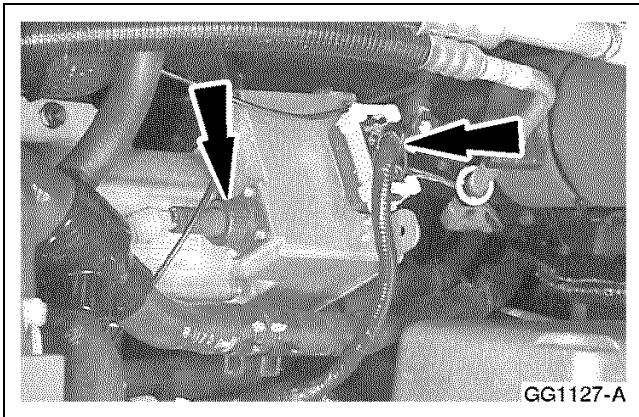

## REMOVAL AND INSTALLATION (Continued)

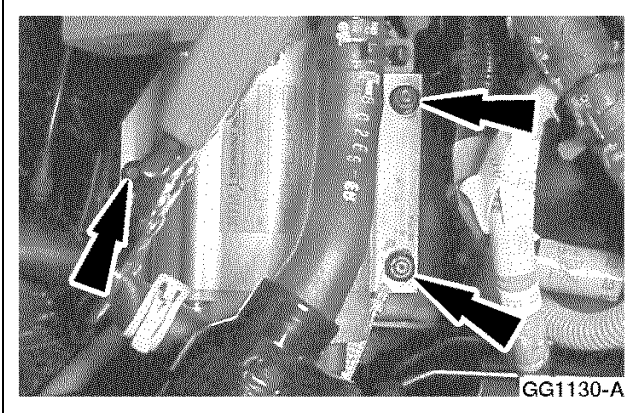

4. Remove the power steering controller assembly.
  - 1 Remove the nuts.
  - 2 Remove the assembly.

### Installation

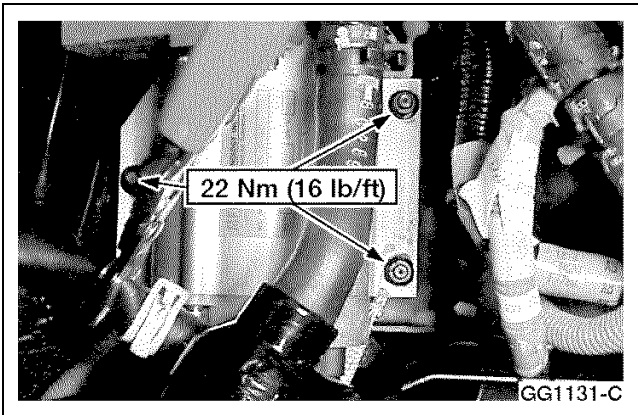

1. To install, reverse the removal procedure.
  - Purge the power steering system of air. Refer to **Section 211-00 of the 2001 Ranger Workshop Manual.**

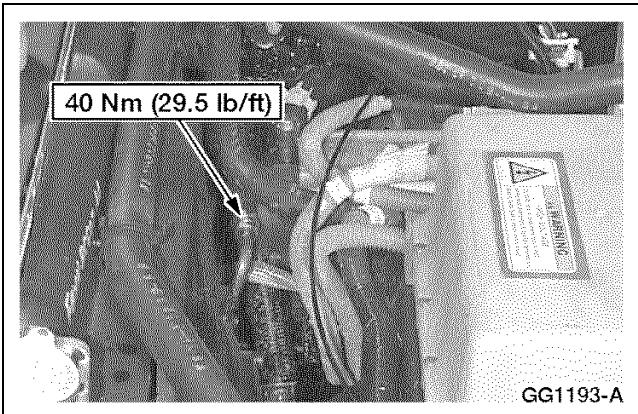

## Power Steering Gear

### Removal

1. Raise and support the vehicle. Refer to [Section 100-02](#).

## REMOVAL AND INSTALLATION (Continued)

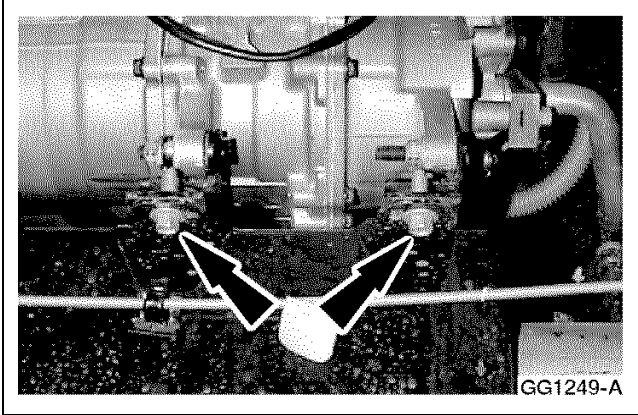

2. **NOTE:** The A/C system is not evacuated for this procedure.

Remove the two front A/C compressor bolts.

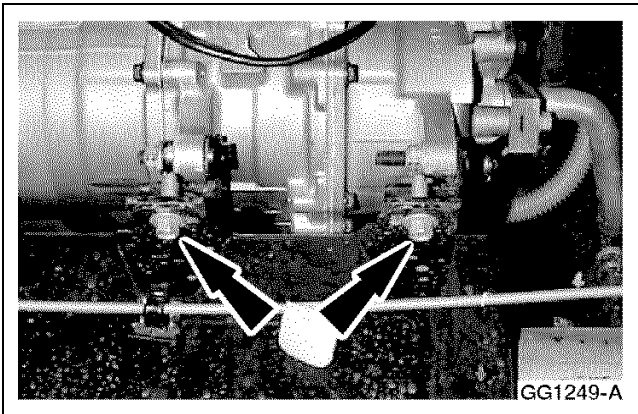

3. **NOTE:** The traction battery has been removed for clarity.

Remove the two rear A/C compressor bolts.

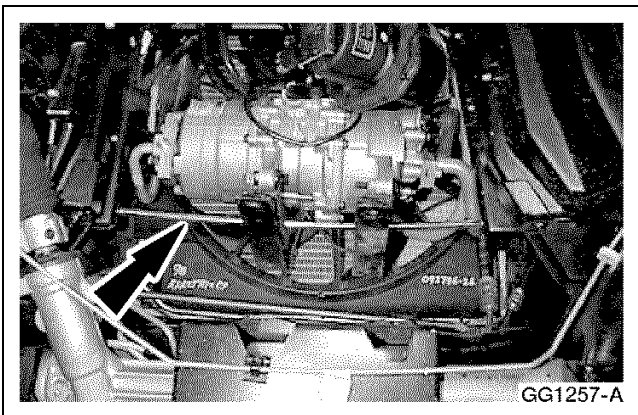

4.  **CAUTION:** Do not force the compressor into position, or damage to the A/C lines may result.

Raise and support the compressor using a 9.5 mm (3/8 in) diameter, 900 mm (36 in) long rod.

- Lift the compressor high enough to slide the rod over the vehicle frame and under the compressor.

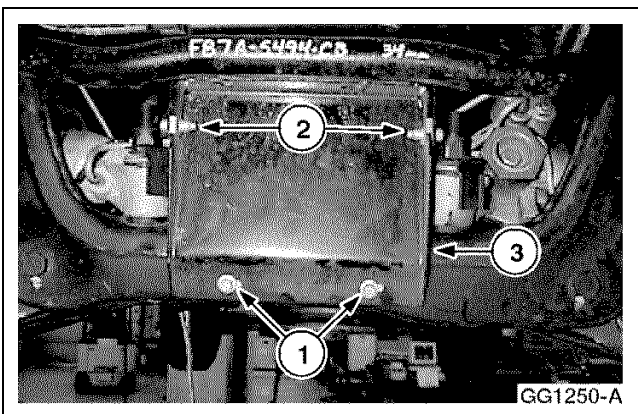

5. Remove the front section of the A/C compressor bracket.

- Remove the two bolts.
- Remove the two bolts.
- Remove the bracket.

## REMOVAL AND INSTALLATION (Continued)

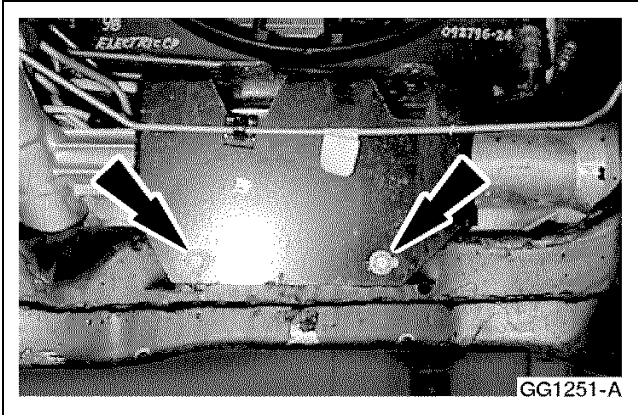

6. **NOTE:** The traction battery has been removed for clarity.

Remove the two rear bracket bolts.

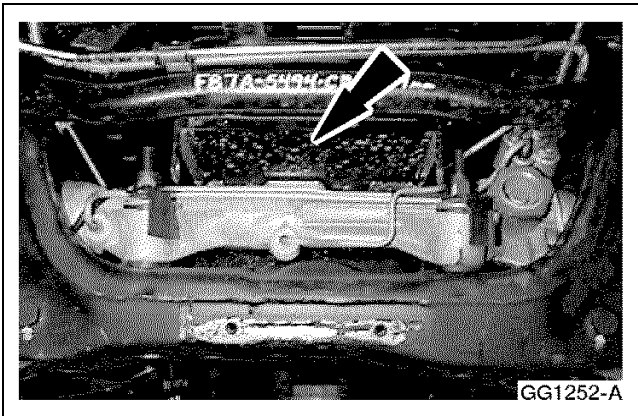

7. Remove the rear half of the A/C compressor bracket.

8. The power steering gear is the same as the gasoline powered Ranger. Remove the power steering gear. Refer to the **2001 Ranger Workshop Manual**.

### Installation

1. To install, reverse the removal procedure.

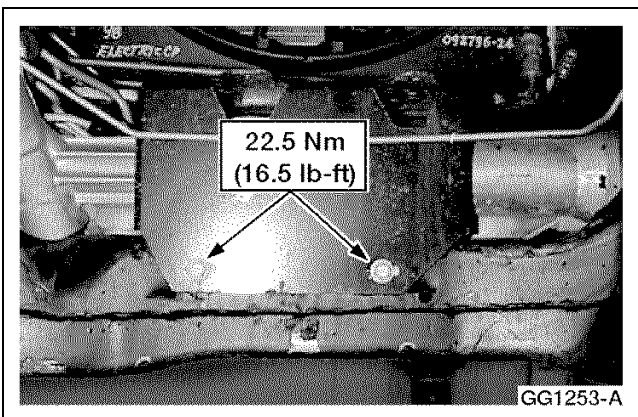

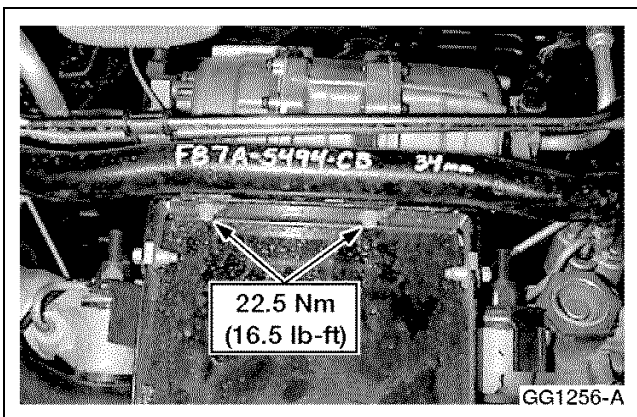
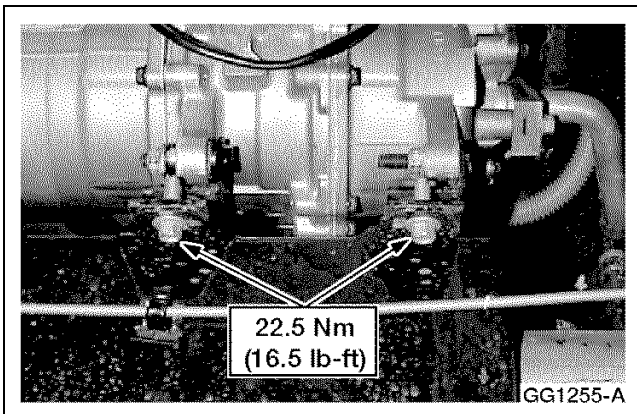
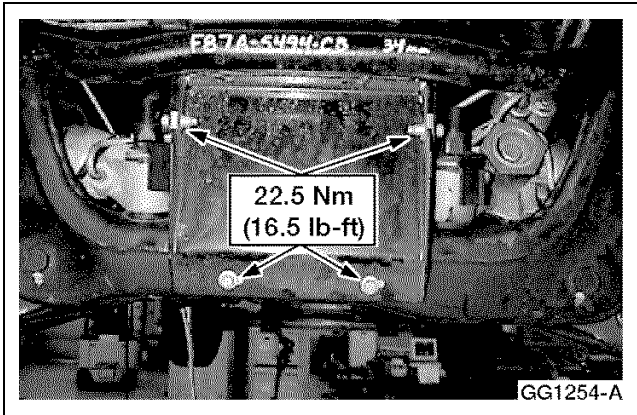
**REMOVAL AND INSTALLATION (Continued)****Power Steering Gear —Postal Ranger EV****Removal and Installation**

1. The power steering gear is the same as the gasoline powered Ranger. For additional information, refer to **Section 211-02 of the 2001 Ranger Workshop Manual**.

## REMOVAL AND INSTALLATION (Continued)

### Power Steering Pump Hoses —Pressure Hose

#### Removal

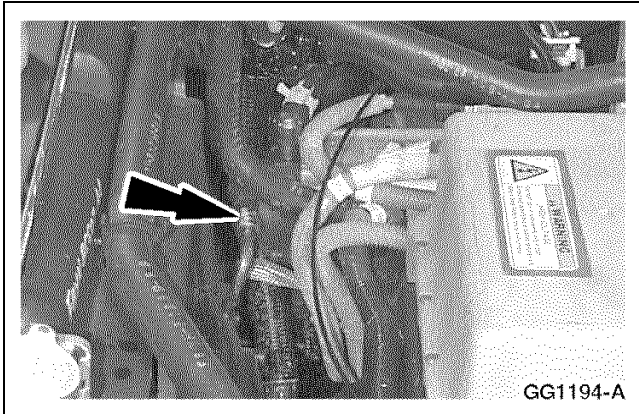

1. Disconnect the pressure hose from the power steering pump.

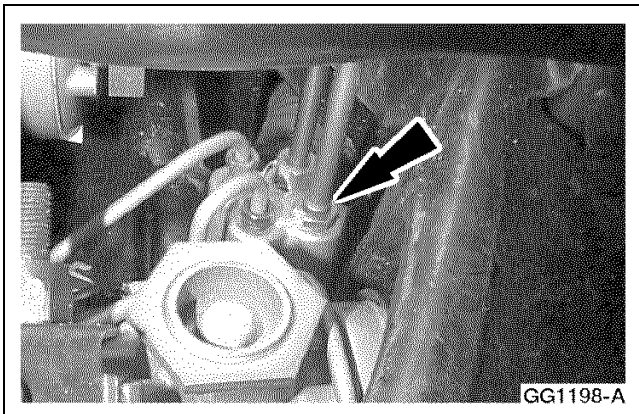

2. Raise and support the vehicle. Refer to [Section 100-02](#).
3. Disconnect the pressure hose from the steering gear.

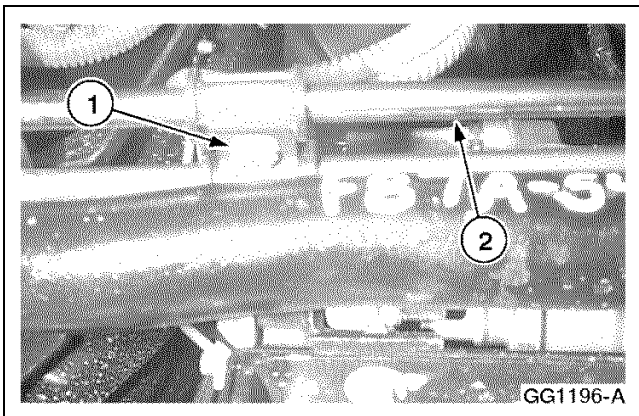

4. Remove the pressure hose.
  - 1 Remove the clamp bolt.
  - 2 Remove the pressure hose.



**REMOVAL AND INSTALLATION (Continued)****Installation**

1. To install, reverse the removal procedure.
  - Purge the power steering system of air. Refer to **Section 211-00 of the 2001 Ranger Workshop Manual**.

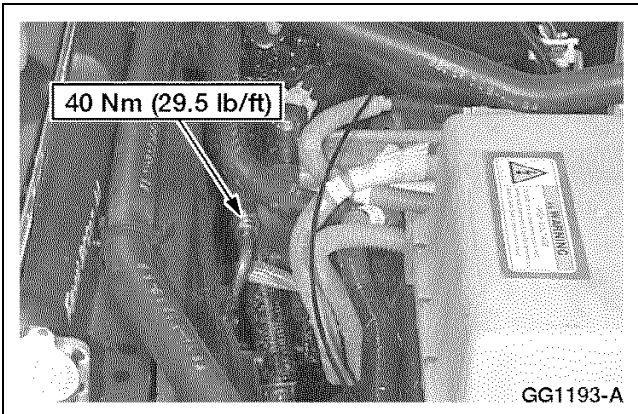
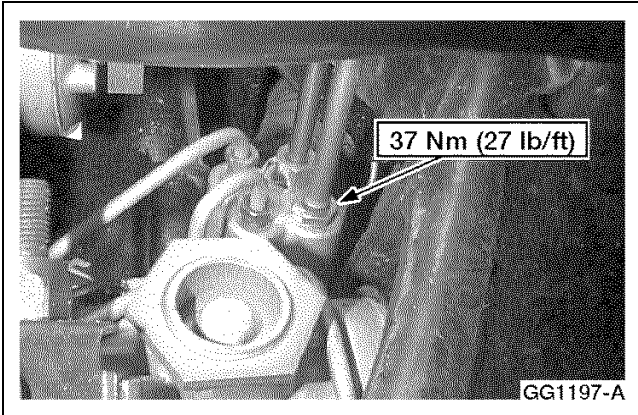
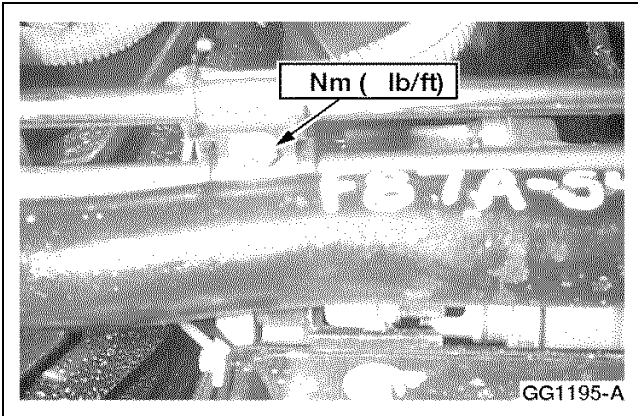

## REMOVAL AND INSTALLATION (Continued)

### Power Steering Pump Hoses — Pressure Hose - Postal Ranger EV

#### Removal

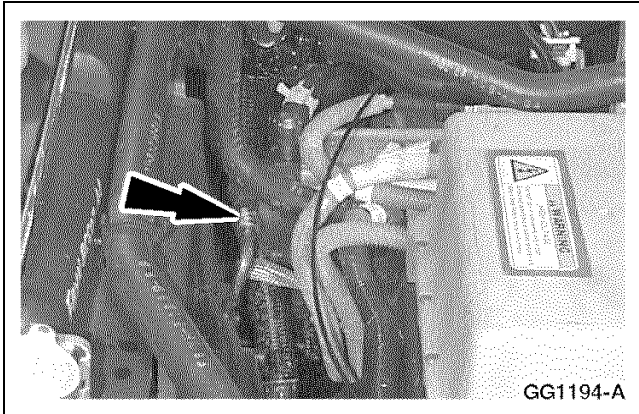

1. Disconnect the pressure hose from the power steering pump.

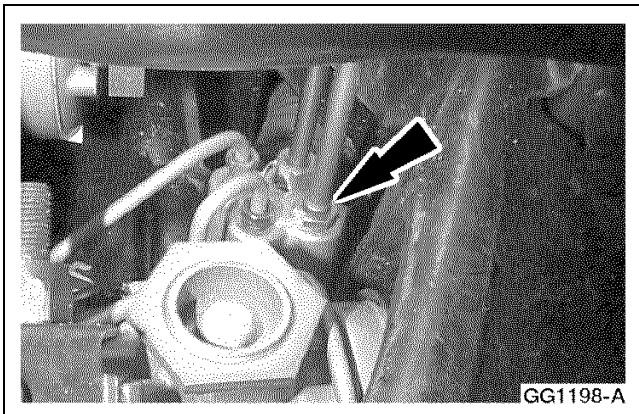

2. Raise and support the vehicle. For additional information, refer to [Section 100-02](#).
3. Disconnect the pressure hose from the steering gear.

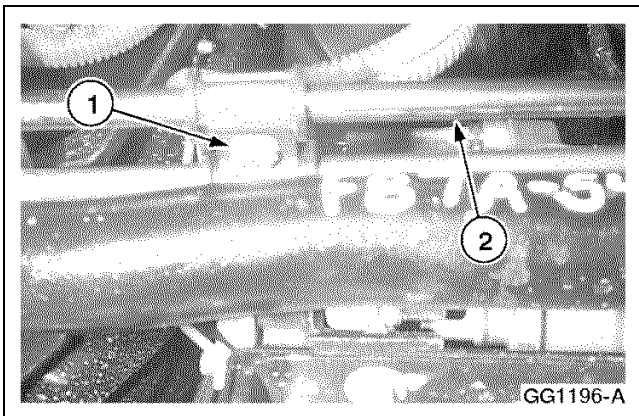

4. Remove the pressure hose.
  - 1 Remove the clamp bolt.
  - 2 Remove the pressure hose.

**REMOVAL AND INSTALLATION (Continued)****Installation**

1. To install, reverse the removal procedure.
  - Purge the power steering system of air. Refer to **Section 211-00 of the 2001 Ranger Workshop Manual**.

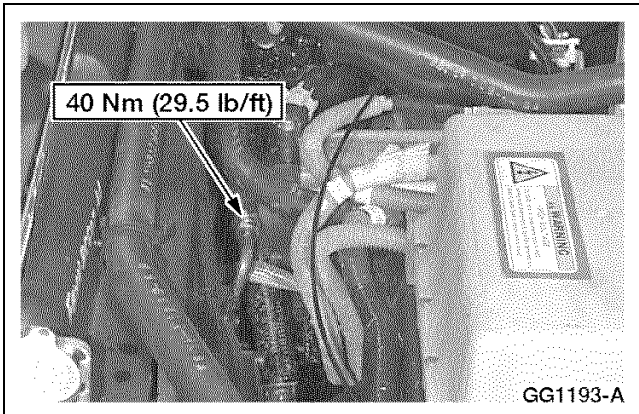
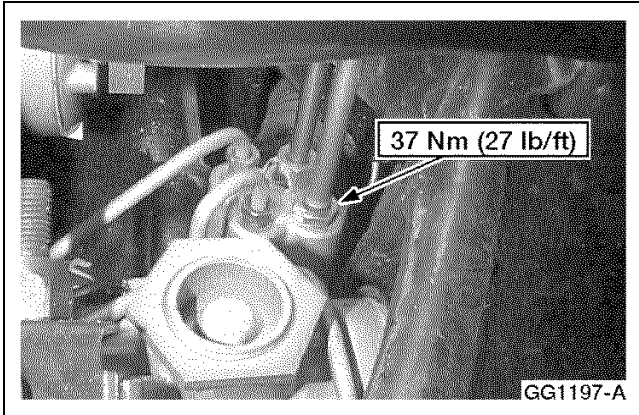
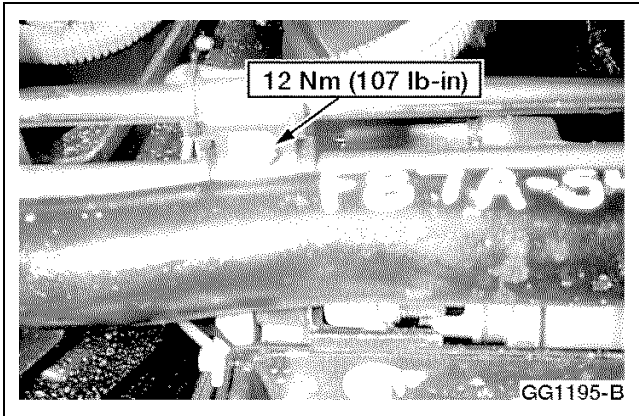

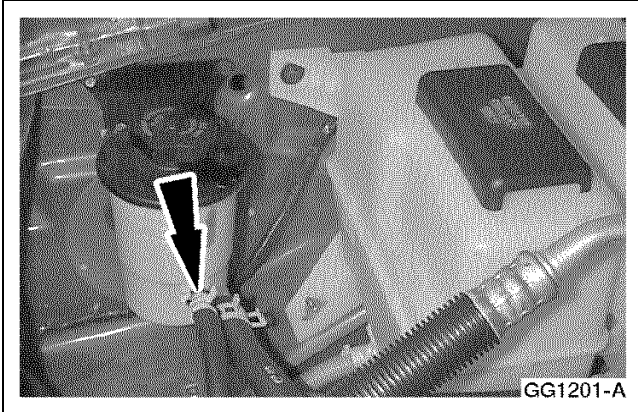
**REMOVAL AND INSTALLATION (Continued)****Power Steering Pump Hoses —Return Hose****Removal**

1. Disconnect the return hose from the reservoir.

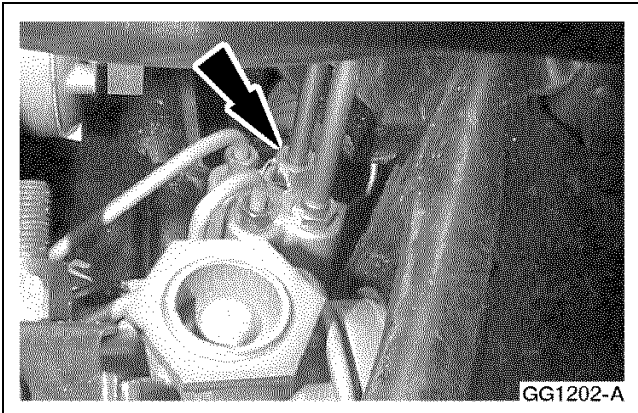

2. Disconnect the return hose from the steering gear.

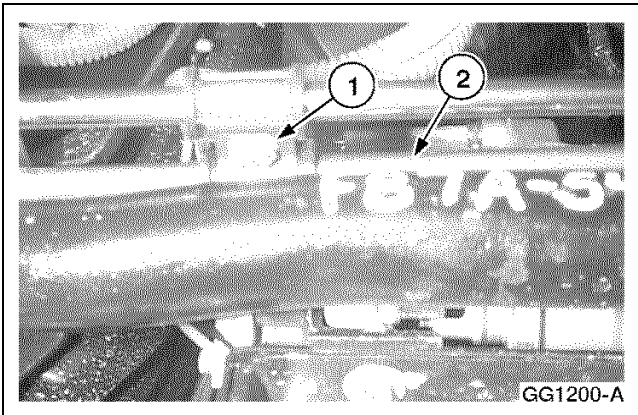

3. Remove the return hose.
  - 1 Remove the clamp bolt.
  - 2 Remove the return hose.

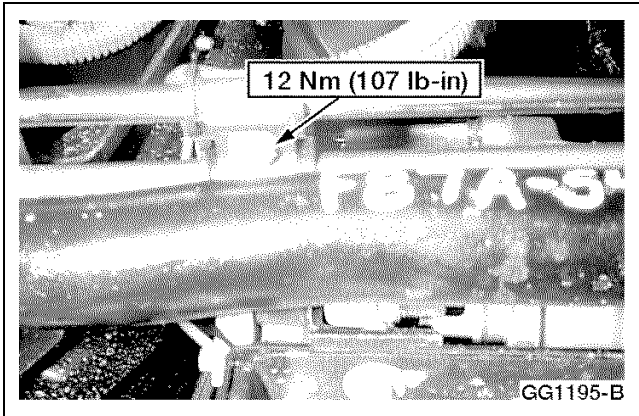
**REMOVAL AND INSTALLATION (Continued)****Installation**

1. To install, reverse the removal procedure.
  - Purge the power steering system of air. Refer to **Section 211-00 of the 2001 Ranger Workshop Manual**.

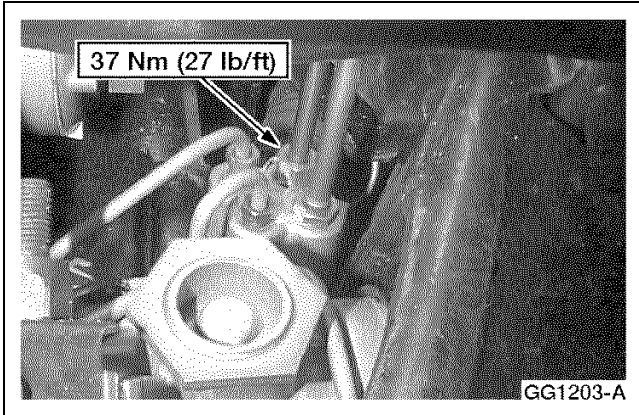
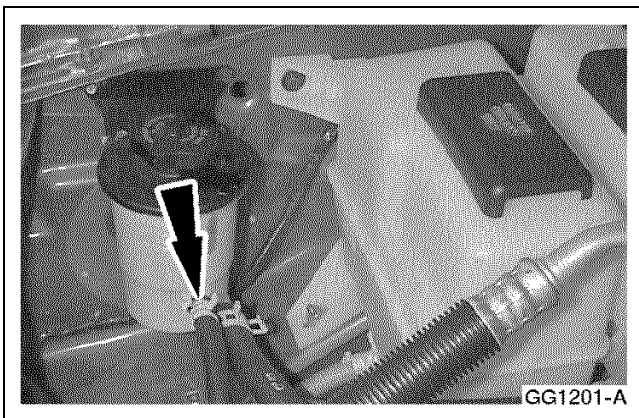
**Power Steering Pump Hoses —Return Hose - Postal Ranger EV****Removal**

1. **NOTE:** Electric Ranger shown, Postal Ranger EV similar.  
Disconnect the return hose from the reservoir.

## REMOVAL AND INSTALLATION (Continued)

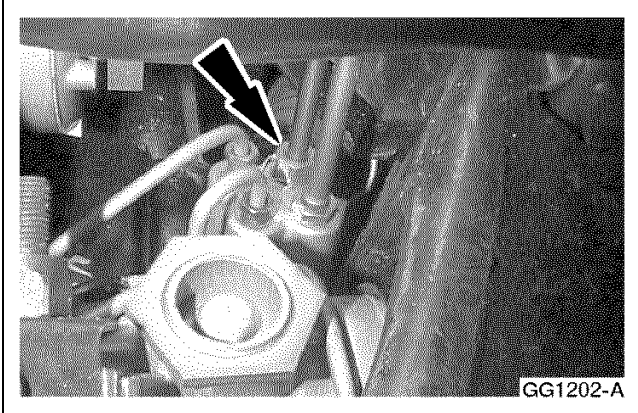

2. Disconnect the return hose from the steering gear.

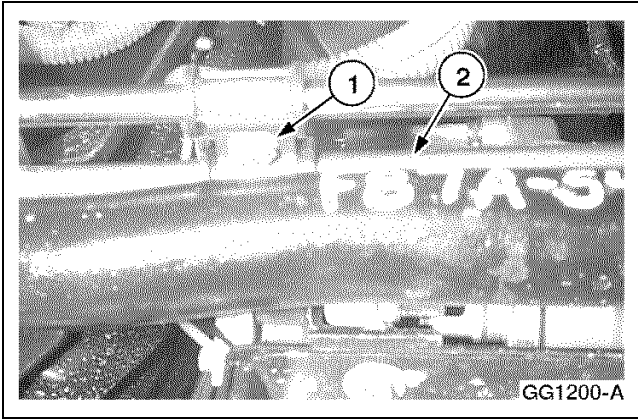

3. Remove the return hose.
  - 1 Remove the clamp bolt.
  - 2 Remove the return hose.

### Installation

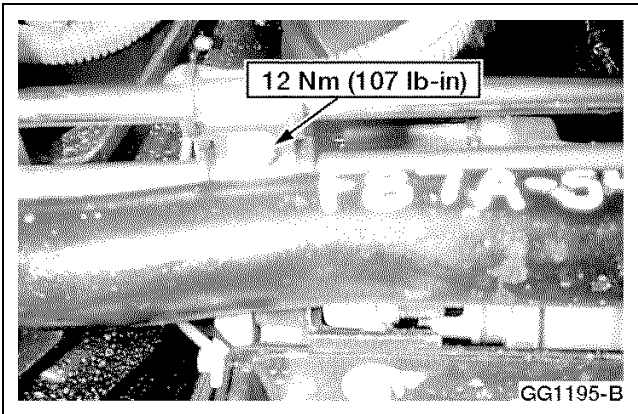

1. To install, reverse the removal procedure.
  - Purge the power steering system of air. Refer to **Section 211-00 of the 2001 Ranger Workshop Manual.**

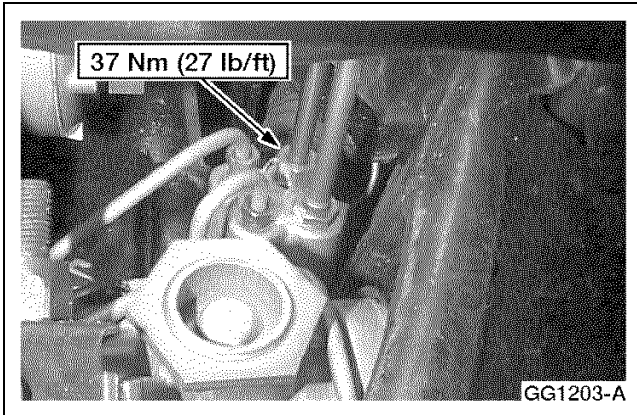
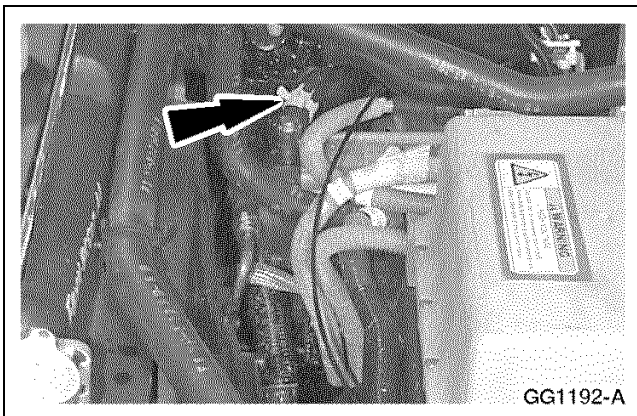
**REMOVAL AND INSTALLATION (Continued)****Power Steering Pump Hoses —Supply Hose****Removal**

1. Disconnect the supply hose from the power steering pump.

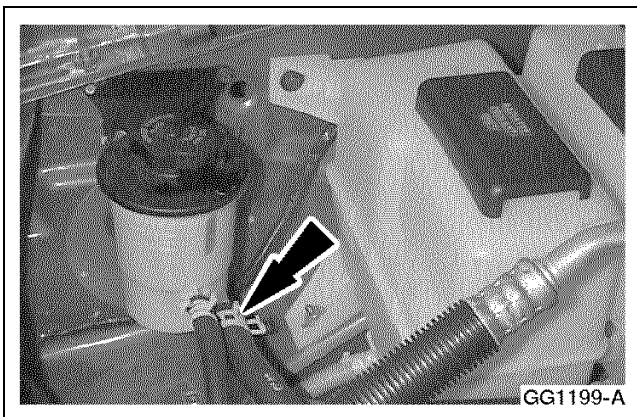

2. Disconnect the supply hose from the reservoir.

3. Remove the supply hose.

## REMOVAL AND INSTALLATION (Continued)

### Installation

1. To install, reverse the removal procedure.
    - Purge the power steering system of air. Refer to **Section 211-00 of the 2001 Ranger Workshop Manual**.
- 

## Power Steering Pump Hoses —Supply Hose - Postal Ranger EV

### Removal

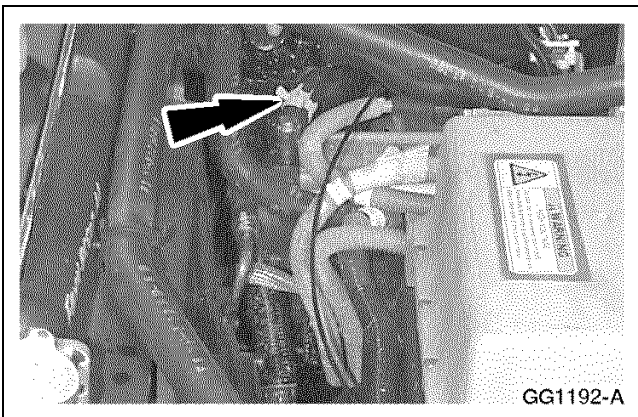

1. Disconnect the supply hose from the power steering pump.

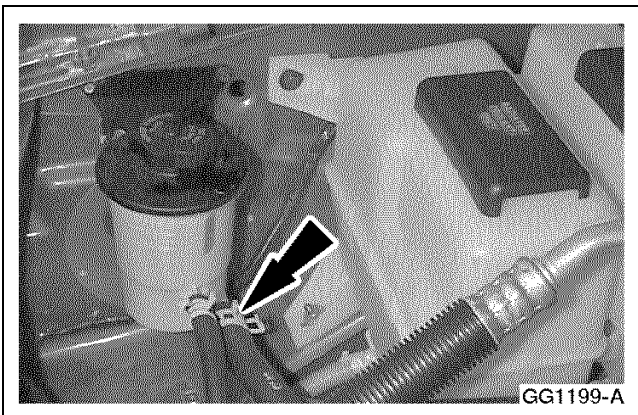

2. **NOTE:** Electric Ranger shown, Postal Ranger EV similar.  
Disconnect the supply hose from the reservoir.

3. Remove the supply hose.

### Installation

1. To install, reverse the removal procedure.
    - Purge the power steering system of air. Refer to **Section 211-00 of the 2001 Ranger Workshop Manual**.
-

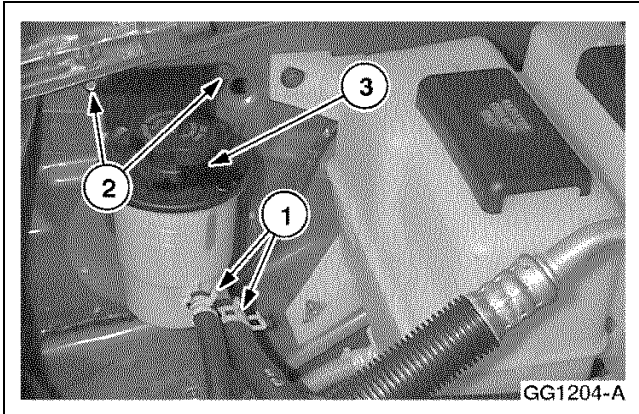

**REMOVAL AND INSTALLATION (Continued)****Power Steering Reservoir****Removal**

1. Remove the power steering reservoir.
  - 1 Disconnect the lines.
  - 2 Remove the screws.
  - 3 Remove the reservoir.

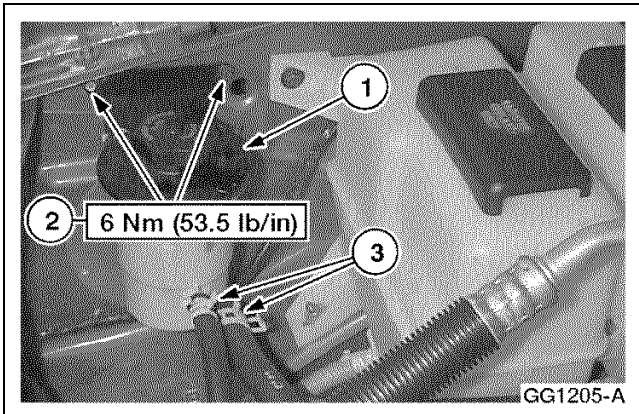
**Installation**

1. Install the power steering reservoir.
  - 1 Position the reservoir.
  - 2 Install the screws.
  - 3 Connect the hoses.
2. Purge the power steering system of air. Refer to **Section 211-00 of the 2001 Ranger Workshop Manual.**

## REMOVAL AND INSTALLATION (Continued)

### Power Steering Reservoir —Postal Ranger EV

#### Removal and Installation

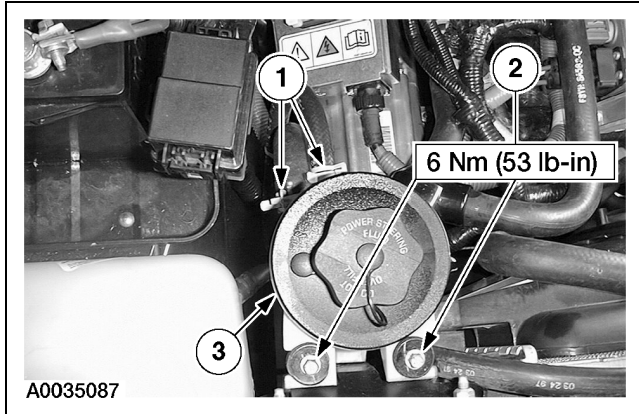

1. Remove the power steering reservoir.
  - 1 Disconnect the lines.
  - 2 Remove the bolts.
  - 3 Remove the reservoir.

2. To install, reverse the removal procedure.
  - Purge the power steering system of air. For additional information, refer to **Section 211-00 of the 2001 Ranger Workshop Manual**.

### Steering Wheel Sensor

#### Removal

1. **NOTE:** The steering wheel sensor is located on the steering column inside the cab. It is visible from below the instrument panel.  
Remove the two sensor screws.
2. Disconnect the sensor electrical connector and remove the sensor.

#### Installation

1. Position the sensor and connect the electrical connector.
2. Install the two sensor bolts.
  - Refer to Specification Chart for torque information.

---

[Manual Table of Contents](#)

## SECTION 211-05 Steering Column Switches

VEHICLE APPLICATION: Ranger EV

CONTENTS	PAGE
<b>DESCRIPTION AND OPERATION</b>	
Steering Column Switches.....	<a href="#">211-05-2</a>

## DESCRIPTION AND OPERATION

### Steering Column Switches

The key positions on the Electric Ranger are the same as on the gasoline-powered Ranger. There are five key positions. They are ACC, LOCK, OFF, RUN, and START.

#### Off, Lock, and Accessory

Vehicle charging can be done when the vehicle is in either the LOCK or the OFF position. In the LOCK position, the steering wheel is locked into position and the key can be removed. The ACCESSORY position allows use of some accessories, such as the radio and wipers.

#### Run

RUN is the normal operating position for the Electric Ranger. If the key is cycled through the START position and is released to the RUN position, the powertrain is enabled. The vehicle can be charged while in the RUN position, but charge times will likely increase.

#### Start

The key must be cycled to the START position and released to start the Electric Ranger. This should be done with the vehicle in PARK. Since the powertrain for the Electric Ranger is virtually silent, the operator should refer to the enabled gauge in the upper right corner of the cluster to determine if the vehicle has been started.

### Traction Bus Operation

After a key transition from OFF to RUN, if the vehicle is not being charged the traction inverter module (TIM) will begin to precharge the traction high-voltage bus. This is accomplished by sending a hardware signal from the TIM to the contactor box indicating the need for precharging the high-voltage bus. On receipt of this signal, the contactor box closes the negative main contactor, delays for a fraction of a second, and closes the main precharge contactor. The bus voltage then rises in the TIM as charge is transferred from the traction battery to the bus capacitors in the TIM via a current limiting resistor located in the contactor box. The TIM remains in this state for up to five minutes or until the key switch position is changed. If the key is then placed in the START position and released, the TIM commands the main traction contactor closed and then opens the main precharge contactor. At this time the TIM transmits a message via standard corporate protocol (SCP) to the interface adapter assembly (IAA) module indicating that the traction system is enabled, and the IAA module activates the motor enabled gauge. When the key is returned to the OFF or LOCK position, the TIM commands the contactors to open and inform the IAA module that the motor is not enabled, thus returning the traction system to the off state.

---

**DESCRIPTION AND OPERATION (Continued)****Auxiliary Bus Operation**

After a key transition from OFF to RUN, the IAA module will wake up and request authority to use the high-voltage auxiliary bus from the battery control module (BCM). If the BCM grants the authority, the IAA module will request the auxiliary bus to close. The contactor box will close the negative main contactor and the auxiliary precharge contactor, thus allowing charge to flow from the traction battery to the direct current to direct current (DC/DC) converter, A/C inverter motor controller (IMC), power steering module, and the positive temperature coefficient (PTC) switching module, thereby charging their internal bus capacitors. When the voltage differential between the traction battery and the auxiliary bus is below 20 volts, the contactor box closes the auxiliary bus contactor and signals to the IAA module the completion of this operation. At this time, the IAA module will enable the DC/DC converter, power steering system, and if commanded, the climate control system. When the key is switched back to OFF, the auxiliary bus contactor is opened. If the vehicle is being charged, the IAA module may close the auxiliary contactor in order to operate the DC/DC converter. If this happens, the contactor will be closed for 10 minutes per cycle.

# GROUP

# 3

# Powertrain

---

SECTION TITLE	PAGE
Basic Motor/Transaxle .....	303-01-1
Engine Cooling .....	303-03-1
Electric Motor Management .....	303-14-1
Automatic Transaxle External Controls .....	307-05-1
Acceleration Control .....	310-02-1

---

## SECTION 303-01 Basic Motor/Transaxle

VEHICLE APPLICATION: Ranger EV

CONTENTS	PAGE
<b>SPECIFICATIONS</b> .....	303-01-2
<b>DESCRIPTION AND OPERATION</b>	
Basic Motor/Transaxle .....	303-01-2
<b>DIAGNOSIS AND TESTING</b>	
Motor/Transaxle Lubrication System .....	303-01-3
Electrical Schematic .....	303-01-3
Inspection and Verification .....	303-01-3
Pinpoint Tests .....	303-01-3
Symptom Chart .....	303-01-3
<b>GENERAL PROCEDURES</b>	
Oil Change Procedure .....	303-01-7
Oil Level Check Procedure .....	303-01-6
<b>REMOVAL AND INSTALLATION</b>	
Motor/Transaxle .....	303-01-10

## SPECIFICATIONS

### General Specifications

Item	Specification
Tribolube L-6 Pro Gear 21	F8AZ-19M544-A

### Torque Specifications

Description	Nm	Lb-Ft	Lb-In
Cross Bar Bolts	47	34.5	—
Ground Strap Bolt	12	—	107
Halfshaft Flange to Motor/Transaxle Bolts	49	36	—
Lug Nuts	115	84.5	—
Motor/Transaxle LH and RH Mount Bolts	130	96	—
Motor/Transaxle Rear Mount Bolts	115	85	—
Shift Cable Bracket Bolts	20	15	—
Shock Absorber Nut	62	45.5	—
TIM A,- Cable Connector Nuts	15	11	—
TIM B,+ Cable Connector Nuts	30	22	—
TIM C Cable Connector Nut	20	14.5	—
TIM A,B,C Cable Connector Nut	3	—	26

(Continued)

### Torque Specifications

Description	Nm	Lb-Ft	Lb-In
TIM +,-Cable Sleeve Nuts	5	—	44.5
Traction Inverter Motor Controller (TIM) Cover Plate Bolts	5	—	44.5

### Torque Specifications

Description	Nm	Lb-Ft	Lb-In
Backing Plate Bolts	15	11	—
Brake Line Bracket to Axle Bolt	12	—	107
Caliper Adapter Bolts	55	40.5	—
Caliper Bolts	25	18.5	—
Hub Nut	252	186	—
Lower Shock Absorber Nut	62.5	46	—
Lug Nuts	115	85	—
Rear Spring Mounting Bolts	116	85	—
Spring Clamp Plate Bolts	103	43	—
Upper Shock Absorber Nut	55	40.5	—

## DESCRIPTION AND OPERATION

### Basic Motor/Transaxle

The Electric Ranger uses a combination four-pole, three-phase alternating current (A/C) motor and single speed transaxle to drive the vehicle. The motor/transaxle is located between the rear wheels and transfers power to the rear wheels through two halfshafts. The motor provides a peak output of 67 kW (90 hp) and 190 Nm (140 lb-ft) of torque.

A shift cable is connected to the motor/transaxle to transmit driver gear selection. The cable operates a digital transmission range (TR) sensor that feeds information to the traction inverter module (TIM). The shift cable does not operate any mechanical devices in the motor/transaxle other than a parking pawl.

The motor/transaxle is lubricated with Tribolube - L6 (Pro Gear 21) F8AZ-19M544-A oil. The oil is pumped throughout the motor/transaxle by a twelve-volt direct current oil pump located inside the motor/transaxle case. Operation of the oil pump is controlled by the TIM. Oil pressure is kept at 83-124 kPa (12-18 psi). If oil pressure drops below 27.5 kPa (4 psi), the low oil pressure warning indicator will illuminate.

## DIAGNOSIS AND TESTING

### Motor/Transaxle Lubrication System

#### Diagnostic Trouble Code (DTC) Definition

The following DTC relates to the Motor/Transaxle Lubrication System:

- DTC C1284 Oil Pressure Switch Failure
  - The normal operating pressure of the oil pump is approximately 103 kPa (15 psi). The oil pressure switch provides a digital input to the traction inverter module (TIM) to indicate the status of the motor/transaxle oil pressure. Under normal operating pressure, the oil pressure switch is closed to provide a ground input to the TIM. If the motor/transaxle oil pressure drops below 28 kPa (4 psi), the oil pressure switch opens and signals the TIM of a low oil pressure condition. DTC C1284 is set if the TIM detects the oil pressure switch open for more than 10 minutes while traveling faster than 3.2 km/h (2 mph). If this failure occurs at key START, the power limit warning indicator and low oil pressure warning indicator illuminate and the TIM reduces power to the motor/transaxle. If the oil pressure switch opens while driving, only the low oil pressure indicator illuminates.

#### Symptom Chart

##### Symptom Chart

Condition	Possible Sources	Action
<ul style="list-style-type: none"> <li>• DTC C1284 Oil Pressure Switch Failure</li> </ul>	<ul style="list-style-type: none"> <li>• Fuse.</li> <li>• Low motor/transaxle fluid level.</li> <li>• Motor/transaxle.</li> <li>• Oil pressure switch.</li> <li>• Circuit(s).</li> <li>• Traction inverter module (TIM).</li> <li>• Oil pump relay.</li> </ul>	<ul style="list-style-type: none"> <li>• GO to Pinpoint Test A.</li> </ul>

#### Pinpoint Tests

##### Special Tool(s)

104-Pin Breakout Box (BOB) 418-049 (014-00950) or equivalent
BCM/TIM Breakout Box (BOB) Adapter Cable 418-F212
BCM/TIM Breakout Box (BOB) Overlay 418-F220
Electric Motor/Transaxle Test Box 418-F211

#### Electrical Schematic

Refer to **Electrical and Vacuum Troubleshooting Manual, Cell 26, Motor/Transaxle Control** for schematic and connector information.

#### Inspection and Verification

Refer to [Section 100-07](#).



**DIAGNOSIS AND TESTING (Continued)****PINPOINT TEST A: DTC C1284 OIL PRESSURE SWITCH FAILURE**

TEST STEP	ACTION TO TAKE
<b>A1 CHECK FUSE</b> <ul style="list-style-type: none"> <li>Check 20A fuse 19 in the electric vehicle power distribution box (EVPDB).</li> <li><b>Is the fuse OK?</b></li> </ul>	Yes = GO to <b>A2</b> . No = REPLACE the fuse.
<b>A2 CHECK TRANSAXLE FLUID LEVEL</b> <ul style="list-style-type: none"> <li>Check the transaxle fluid level. Refer to <a href="#">Oil Level Check Procedure</a> in this section.</li> <li><b>Is the fluid level OK?</b></li> </ul>	Yes = GO to <b>A3</b> . No = FILL the motor/transaxle to the appropriate fluid level. REFER to <a href="#">Oil Level Check Procedure</a> in this section
<b>A3 CHECK OIL PUMP CURRENT</b> <ul style="list-style-type: none"> <li>With key OFF, disconnect oil pump C4992 and oil pressure switch C4997.</li> <li>Connect Electric Motor/Transaxle Test Box to the oil pump, oil pressure switch and cigar lighter socket.</li> <li>Set the oil pump power switch on Electric Motor/Transaxle Test Box to the ON position.</li> </ul> <p><b>NOTE:</b> Set the multimeter to voltage measurement. The Electric Motor/Transaxle Test Box measures current that is proportional to the voltage.</p> <ul style="list-style-type: none"> <li>Connect a multimeter to the oil pump current ports on Electric Motor/Transaxle Test Box and measure the voltage.</li> <li><b>Is the voltage between 2.5 and 6.5 volts?</b></li> <li></li> </ul>	Yes = GO to <b>A4</b> . No = REPLACE the motor/transaxle.
<b>A4 CHECK OIL PRESSURE SWITCH</b> <ul style="list-style-type: none"> <li>Observe the oil pump pressure LED on Electric Motor/Transaxle test box.</li> <li><b>Is the oil pump pressure LED on?</b></li> </ul>	Yes = GO to <b>A5</b> . No = REPLACE the oil pressure switch.
<b>A5 CHECK OIL PRESSURE SWITCH STATUS</b> <ul style="list-style-type: none"> <li>Disconnect Electric Motor/Transaxle Test Box from the motor/transaxle and reconnect oil pump C4992 and oil pressure switch C4997.</li> <li>With key ON, monitor the traction inverter module (TIM) PID OILPSWI while turning the ignition key to the START position.</li> <li>Wait approximately 10 seconds.</li> <li><b>Does the OILPSWI PID indicate ACTIVE?</b></li> </ul>	Yes = System OK. CHECK wiring for intermittent connections. No = GO to <b>A6</b> .
<b>A6 CHECK GROUND TO OIL PRESSURE SWITCH</b> <ul style="list-style-type: none"> <li>With key OFF, disconnect oil pressure switch C4997 and measure the resistance between the BK wire on oil pressure switch C4997 and ground.</li> <li><b>Is the resistance less than 5 ohms?</b></li> </ul>	Yes = GO to <b>A7</b> . No = REPAIR the BK wire.
<b>A7 CHECK CIRCUIT 3605 (DB/W) FOR OPEN</b> <ul style="list-style-type: none"> <li>Connect 104-Pin Breakout Box (BOB) to TIM C4998, C4999 using the BCM/TIM BOB Adapter Cable and Overlay; leave the TIM disconnected.</li> <li>With key OFF, measure the resistance of the DB/W wire between BOB pin B12 and ground (BOB pin A29).</li> <li><b>Is the resistance less than 5 ohms?</b></li> </ul>	Yes = GO to <b>A8</b> . No = REPAIR the DB/W wire.
<b>A8 CHECK CIRCUIT 3605 (DB/W) FOR SHORT TO POWER</b>	

(Continued)

**DIAGNOSIS AND TESTING (Continued)****PINPOINT TEST A: DTC C1284 OIL PRESSURE SWITCH FAILURE**

<b>TEST STEP</b>	<b>ACTION TO TAKE</b>
<ul style="list-style-type: none"> <li>With key ON, measure the voltage between BOB pin B12 and ground (BOB pin A29).</li> <li><b>Is the voltage greater than 0 volts?</b></li> </ul>	Yes = REPAIR the DB/W wire. No = GO to A9.
<b>A9 CHECK POWER TO OIL PUMP</b> <ul style="list-style-type: none"> <li>With key OFF, connect TIM to BOB; leave BOB connected to TIM C4998 and C4999.</li> <li>With key OFF, disconnect oil pump C4992.</li> <li>Enter the TIM active command mode FLUID CONTROL and set the active command PUMP to ON.</li> <li>Measure the voltage between pin 2 (P/LG wire) and pin 3 (BK wire) on oil pump C4992.</li> <li><b>Is the voltage greater than 10 volts?</b></li> </ul>	Yes = System OK. CHECK wiring for intermittent connections. No = GO to A10.
<b>A10 CHECK GROUND TO OIL PUMP</b> <ul style="list-style-type: none"> <li>With key OFF, measure the resistance between the BK wire on oil pump C4992 and ground.</li> <li><b>Is the resistance less than 5 ohms?</b></li> </ul>	Yes = GO to A11. No = REPAIR the BK wire.
<b>A11 CHECK OIL PUMP RELAY CONTROL CIRCUIT</b> <ul style="list-style-type: none"> <li>With key OFF, remove the oil pump relay from the relay box.</li> <li>Enter the active command mode FLUID CONTROL, set the active command PUMP to ON, and measure the resistance between BOB pin A37 and ground (BOB pin A29).</li> <li><b>Is the resistance less than 5 ohms?</b></li> </ul>	Yes = GO to A12. No = REPLACE the TIM. REFER to <a href="#">Section 303-14</a> .
<b>A12 CHECK CIRCUITS 3004 (P/LG) AND 3005 (P/LG) FOR OPEN(S)</b> <ul style="list-style-type: none"> <li>With key OFF, disconnect the TIM from the BOB; leave BOB connected to TIM C4998, C4999.</li> <li>With key OFF, measure the resistance of the P/LG wire between pin 2 on the oil pump relay connector and BOB pin A37.</li> <li>With key OFF, measure the resistance of the P/LG wire between pin 5 on the oil pump relay connector and pin 2 on oil pump C4992.</li> <li><b>Are the resistances less than 5 ohms?</b></li> </ul>	Yes = GO to A13. No = REPAIR the P/LG wire(s) in question.
<b>A13 CHECK POWER TO OIL PUMP RELAY</b> <ul style="list-style-type: none"> <li>With key ON, measure the voltage between pins 1, 3 on the oil pump relay connector and ground.</li> <li><b>Are the voltages greater than 10 volts?</b></li> </ul>	Yes = REPLACE the oil pump relay. No = REPAIR the LB/O wire(s) in question.

**PINPOINT TEST B: CHECK TRANSAXLE OIL PRESSURE**

<b>TEST STEP</b>	<b>ACTION TO TAKE</b>
<b>B1 CHECK TRANSAXLE OIL PRESSURE</b> <ul style="list-style-type: none"> <li>Remove the plug from the left rear bottom corner of the transaxle.</li> <li>Install an oil pressure gauge.</li> <li>Set parking brake and turn the key to start position and release.</li> <li>With the transaxle enabled, check the oil pressure.</li> </ul> <ul style="list-style-type: none"> <li><b>Does the oil pressure stay steady (within 3 psi) and above 15 psi for 30 minutes?</b></li> </ul>	Yes = The transaxle lubrication system has an intermittent fault. <ul style="list-style-type: none"> <li>Oil pressure switch</li> <li>Oil switch circuit</li> <li>Oil pump relay</li> <li>Oil pump relay circuit</li> <li>TIM module</li> <li>Transaxle</li> </ul> No = Call the Electric Vehicle Hotline 1-800-826-4694.

## GENERAL PROCEDURES

### Oil Level Check Procedure

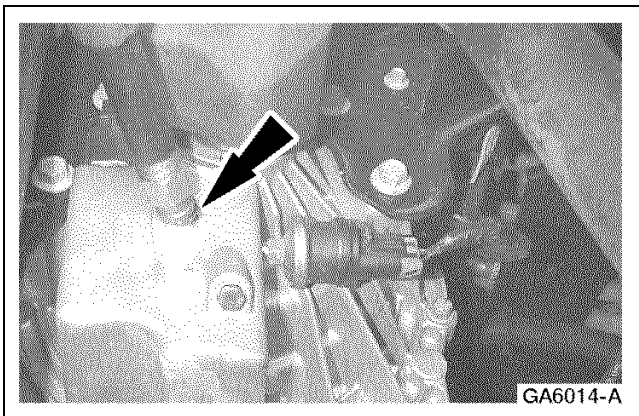
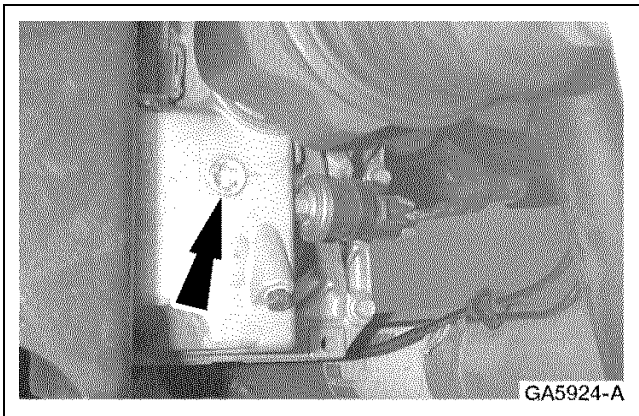
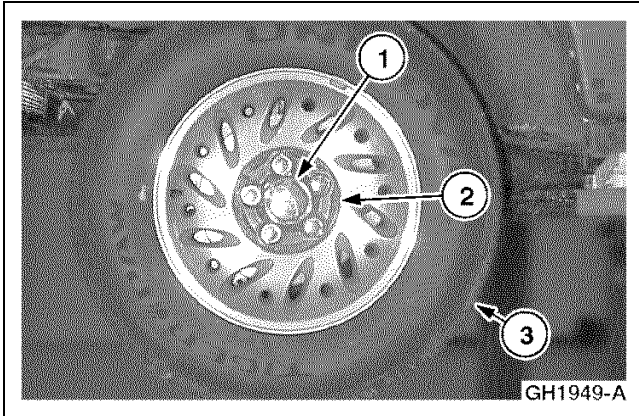

1. Raise and support the vehicle. Refer to [Section 100-02](#).
2. Remove the LH rear wheel.
  - 1 Remove the center cap.
  - 2 Remove the lug nuts.
  - 3 Remove the wheel.
3. Remove the oil fill plug. The motor/transaxle should be filled to the bottom of the fill plug hole.
4. Fill the transaxle to the bottom of the fill plug hole using a clean funnel and hose.

## GENERAL PROCEDURES (Continued)

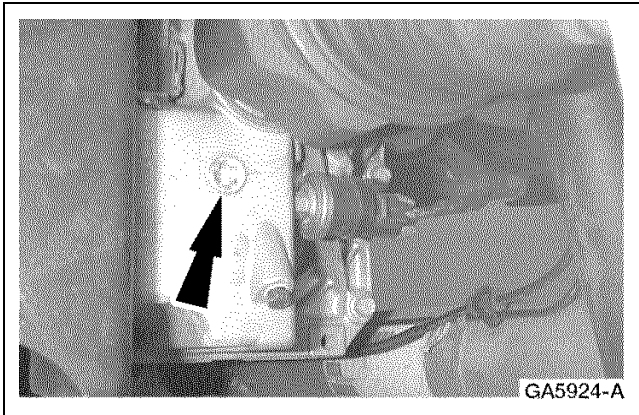

5. Install the fill plug.

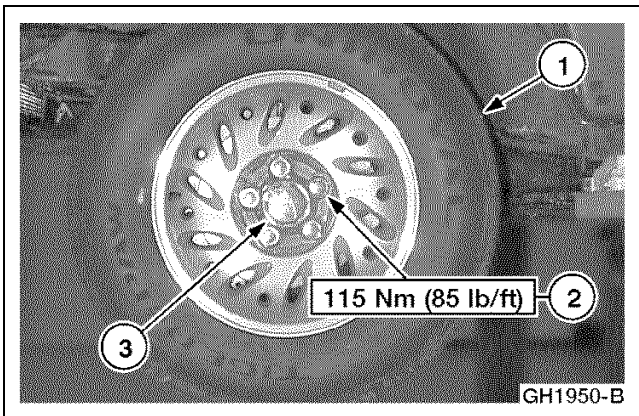

6. Install the wheel.
  - 1 Position the wheel.
  - 2 Install the lug nuts.
  - 3 Install the center cap.

## Oil Change Procedure

### Special Tool(s)

	<p>Electric Motor/Transaxle Test Box 418-F211</p>
--	---

**NOTE:** The oil capacity of the motor/transaxle is approximately 1600 ml (54 oz). This procedure will remove 1000 ml (33 oz) of oil from the motor/transaxle.

1. Plug the Electric Motor/Transaxle Test Box power cord into the cigarette lighter.
2. Raise and support the vehicle. Refer to [Section 100-02](#).

## GENERAL PROCEDURES (Continued)

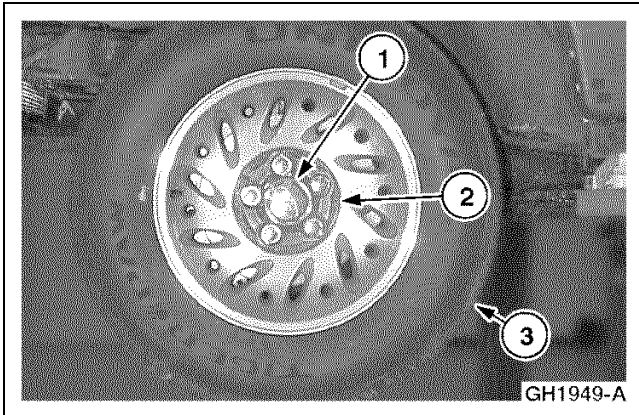

3. Remove the LH rear wheel.
  - 1 Remove the center cap.
  - 2 Remove the lug nuts.
  - 3 Remove the wheel.

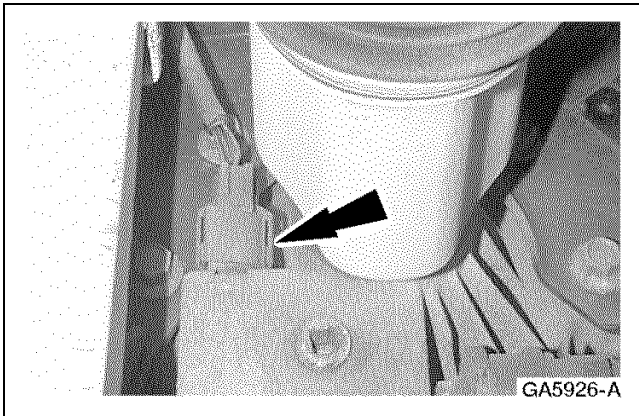

4. Disconnect the oil pump electrical connector.

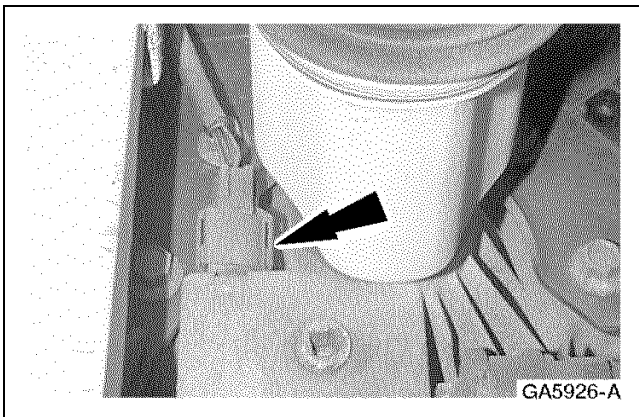

5. Connect the Electric Motor/Transaxle Test Box electrical connector to the oil pump connector.

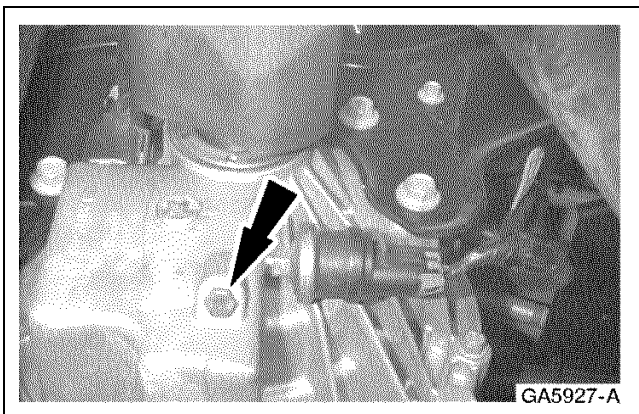

6. Position a catch pan under the motor/transaxle.
7. Remove the motor/transaxle drain plug.

**GENERAL PROCEDURES (Continued)**

8. Turn the Electric Motor/Transaxle Test Box power on. This will activate the oil pump and force the oil out of the motor/transaxle. Leave the power on for two minutes.

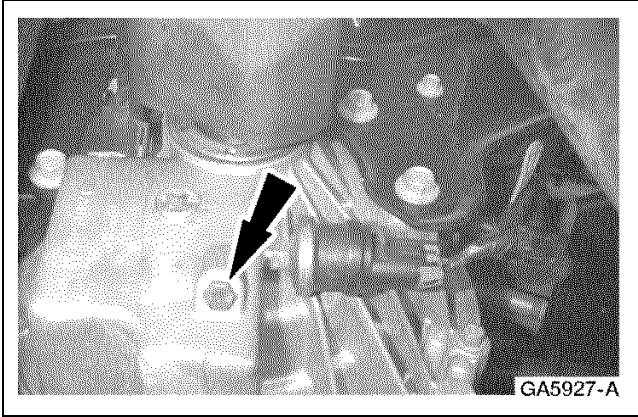

9. Install the drain plug.

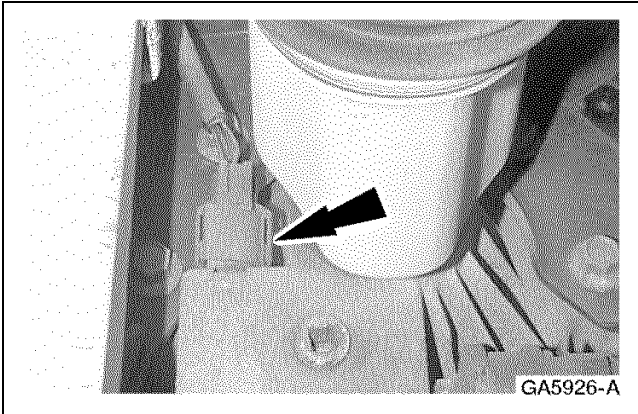

10. Disconnect the Electric Motor/Transaxle Test Box electrical connector from the oil pump connector and connect the oil pump electrical connector.

11. Disconnect the Electric Motor/Transaxle Test Box power cord from the cigarette lighter.

12. Remove the oil fill plug.

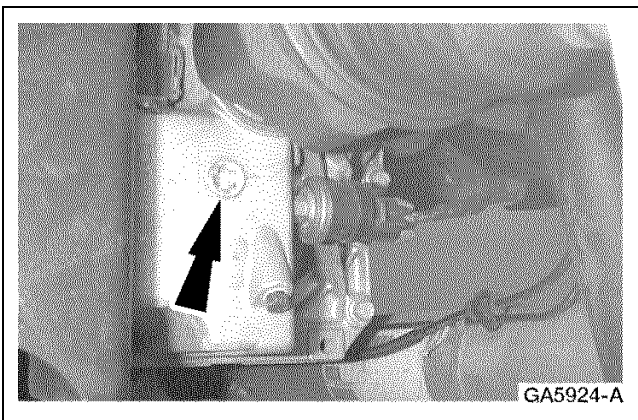

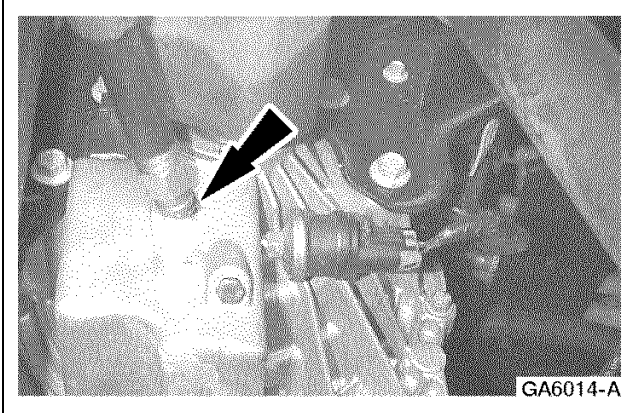
**GENERAL PROCEDURES (Continued)**

13. Add one quart of Tribolube oil. Fill the transaxle using a clean funnel and hose.

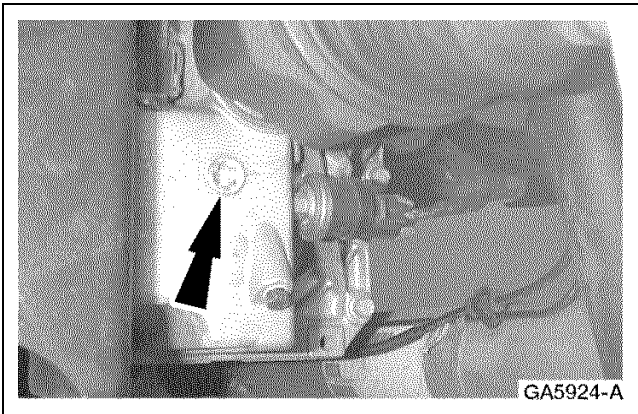

14. Install the fill plug.

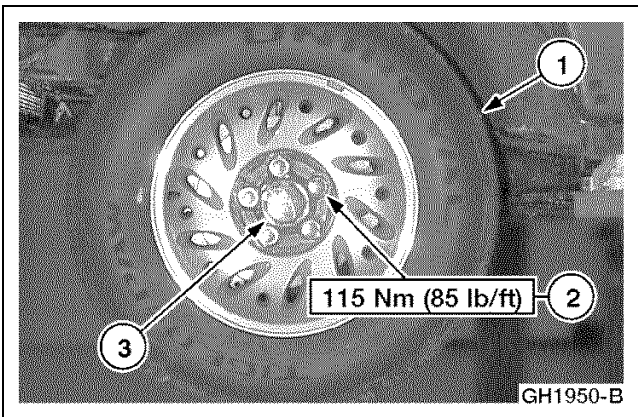

15. Install the wheel.
  - 1 Position the wheel.
  - 2 Install the lug nuts.
  - 3 Install the center cap.

**REMOVAL AND INSTALLATION****Motor/Transaxle****Removal**

1. Disconnect the traction battery two-pin high-voltage connector. Refer to [Section 100-05](#).
2. Discharge the traction inverter module (TIM) capacitors. Refer to [Section 100-05](#).

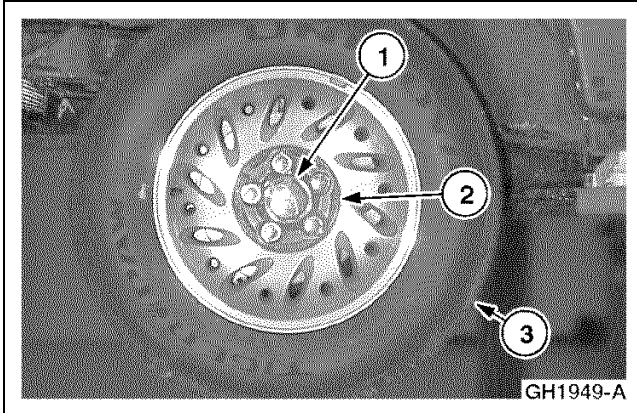
**REMOVAL AND INSTALLATION (Continued)**

3. Remove the LH and RH rear wheels.
  - 1 Remove the center cap.
  - 2 Remove the lug nuts.
  - 3 Remove the wheel.

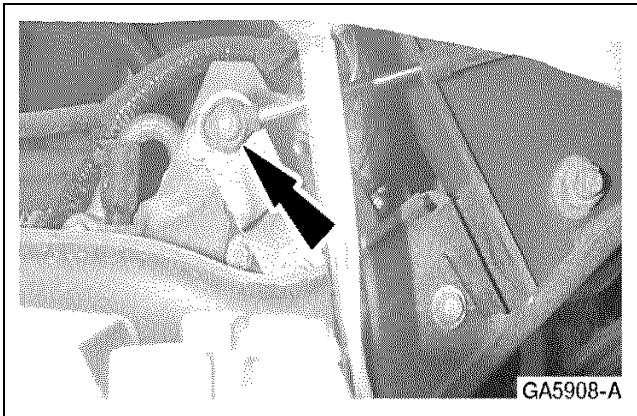

4. Disconnect the shift cable.

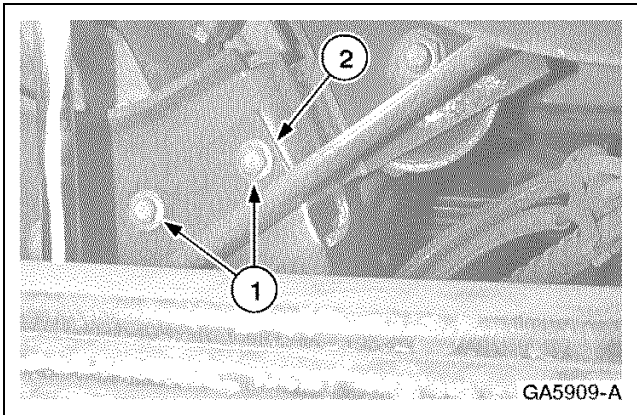

5. Position the shift cable bracket aside.
  - 1 Remove the bolts.
  - 2 Position the shift cable bracket aside.

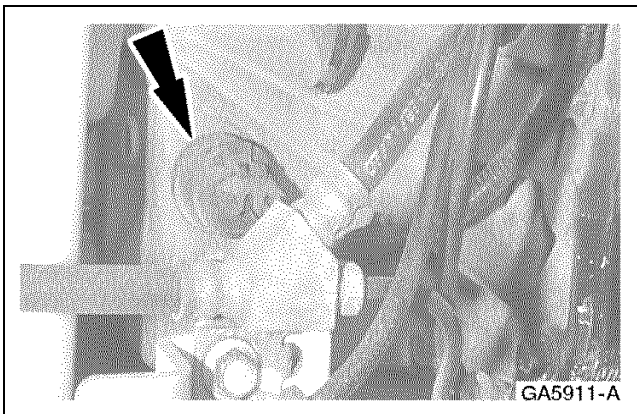

6. Disconnect the oil pressure switch electrical connector from the LH side of the motor/transaxle.



## REMOVAL AND INSTALLATION (Continued)

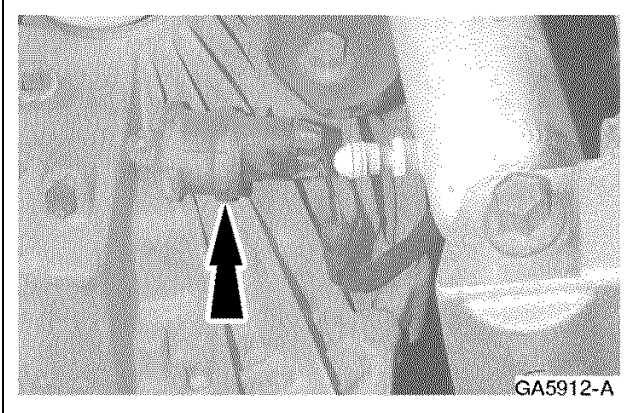

7. Disconnect the oil pump electrical connector from the front LH side of the transaxle.

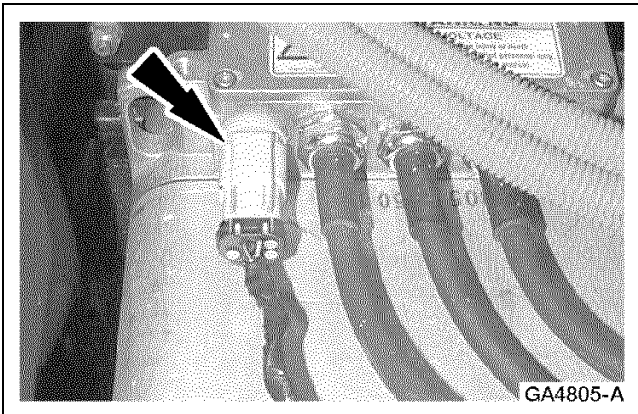

8. **NOTE:** The electrical connector is not visible from the underneath the vehicle. The connector is shown with the box off the pickup for clarity. Disconnect the motor/transaxle electrical connector from the top RH side of the motor/transaxle by pressing on top tab and pulling out.

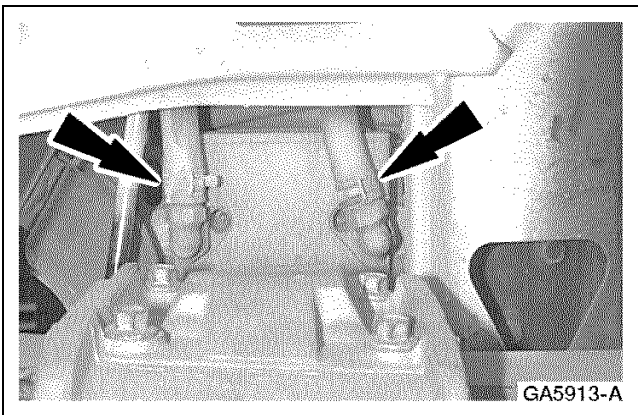

9. **NOTE:** Clamp off the hoses prior to disconnection to avoid coolant loss. Disconnect the motor/transaxle coolant hoses.

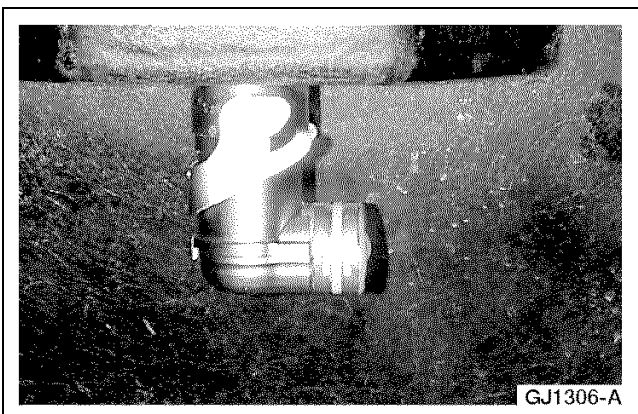

10. Install the Traction Battery High Voltage Lockout and Diagnostic Tool.

## REMOVAL AND INSTALLATION (Continued)

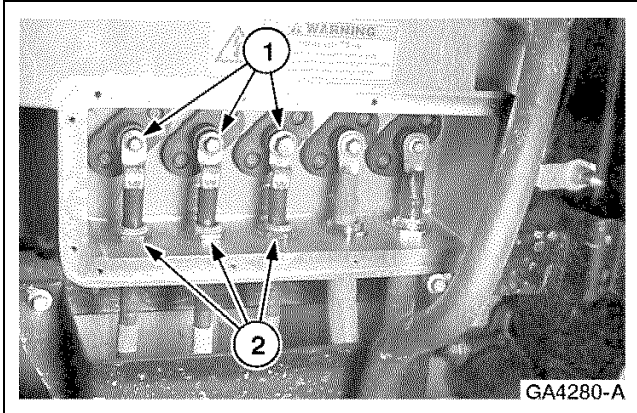

11. Disconnect the TIM to motor/transaxle electrical cables.

- 1 Remove the nuts.
- 2 Remove the sleeve nuts and slide the cables out of the TIM.

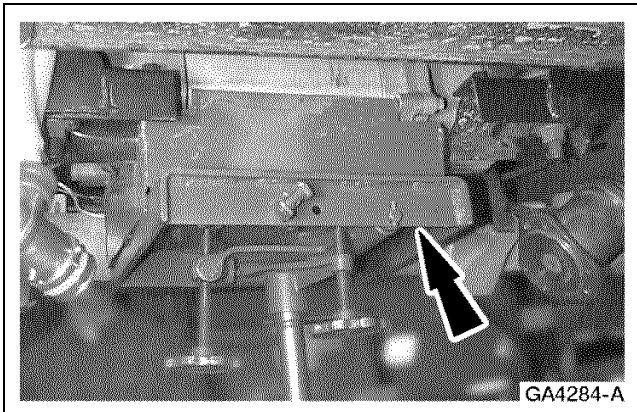

12. Support the motor/transaxle using a high lift jack.

- Strap the motor/transaxle to the high lift jack to secure the motor/transaxle.

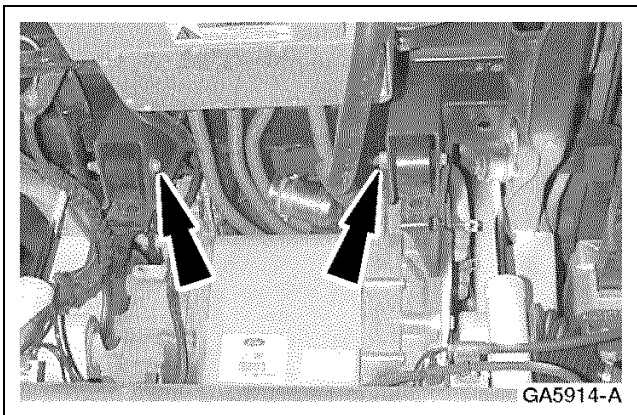

13. Remove the two rear mount bolts.

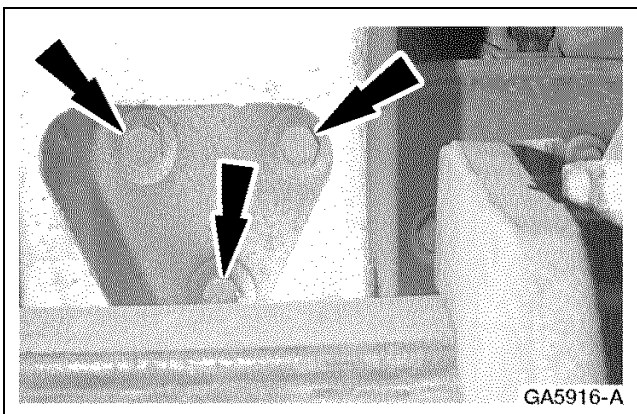

14. **NOTE:** LH shown, RH similar.

Remove the three LH and RH mounting bracket bolts.

## REMOVAL AND INSTALLATION (Continued)

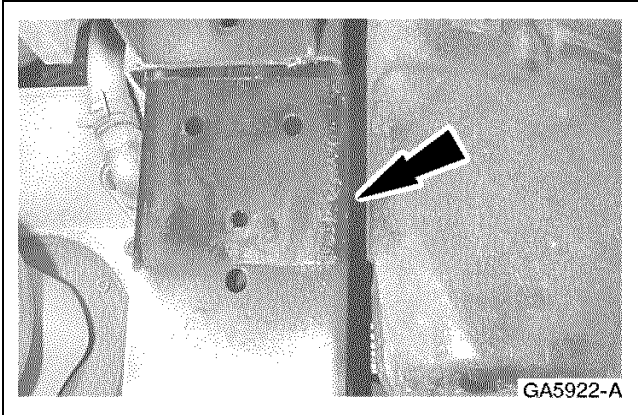

15. **⚠ CAUTION:** Do not lower the motor/transaxle more than 4 inches (102 mm) or damage to the motor/transaxle electrical connections may occur.

Lower the motor/transaxle 4 inches (102 mm) to expose the top of the motor/transaxle frame.

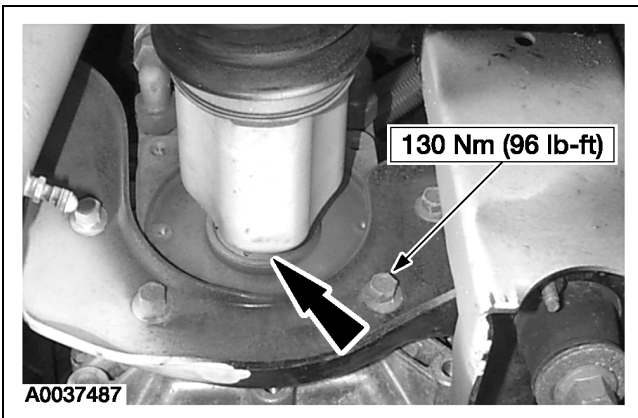

16. **NOTE:** If installing a new motor/transaxle, remove the LH and RH bracket bolts.

Disconnect the halfshaft from the motor/transaxle.

17. Lower the motor/transaxle and remove from the vehicle.

### Installation

1. To install, reverse the removal procedure.

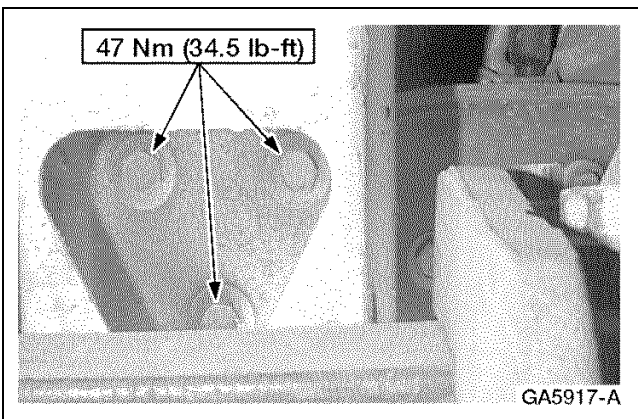

REMOVAL AND INSTALLATION (Continued)

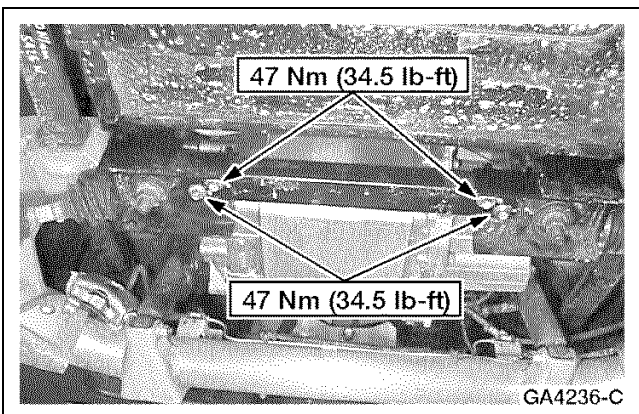
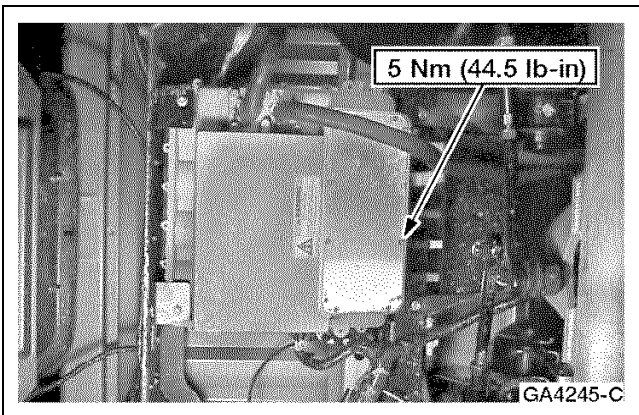
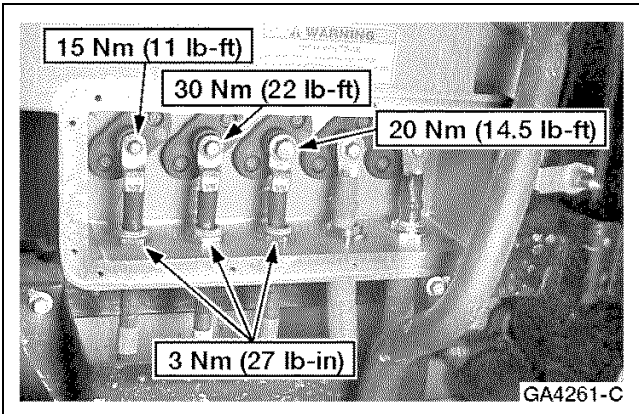
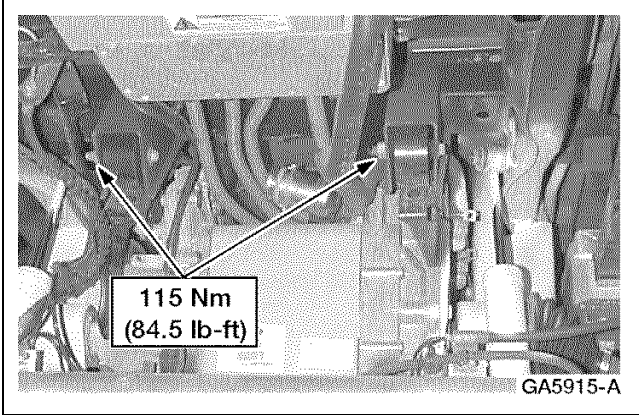

**REMOVAL AND INSTALLATION (Continued)**

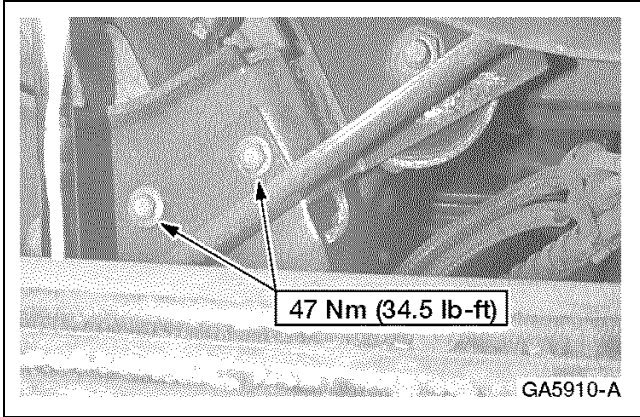

---

 Manual Table of Contents

## SECTION 303-03 Engine Cooling

VEHICLE APPLICATION: Ranger EV

CONTENTS	PAGE
<b>SPECIFICATIONS</b> .....	303-03-2
<b>DESCRIPTION AND OPERATION</b>	
Cooling System.....	303-03-2
Cooling System —Postal Ranger EV .....	303-03-3
<b>DIAGNOSIS AND TESTING</b>	
Cooling System.....	303-03-4
Diagnostic Trouble Code (DTC) Definition .....	303-03-4
Electrical Schematic .....	303-03-4
Inspection and Verification .....	303-03-4
Pinpoint Tests.....	303-03-5
Symptom Chart .....	303-03-5
<b>GENERAL PROCEDURES</b>	
Cooling System Drain, Fill and Bleed.....	303-03-10
<b>REMOVAL AND INSTALLATION</b>	
Coolant Pump .....	303-03-14
Coolant Pump —Postal Ranger EV .....	303-03-15
Cooling Fan .....	303-03-17
Cooling System Tubes and Hoses .....	303-03-18
Cooling System Tubes and Hoses —Postal Ranger EV .....	303-03-20

## SPECIFICATIONS

### Torque Specifications

Description	Nm	Lb-Ft	Lb-In
Coolant pump bolt	11	8	—
Coolant tube clamp screws	7	—	62
Radiator fan bolts	6	—	54

### General Specifications

Item	Specification
Cooling System Capacity	11.36 l (3 gal)
Premium Cooling System Fluid E2FZ-19549-AA	ESE-M97B44-A
Pressure Relief Cap	110.5 kPa (16 psi)

## DESCRIPTION AND OPERATION

### Cooling System

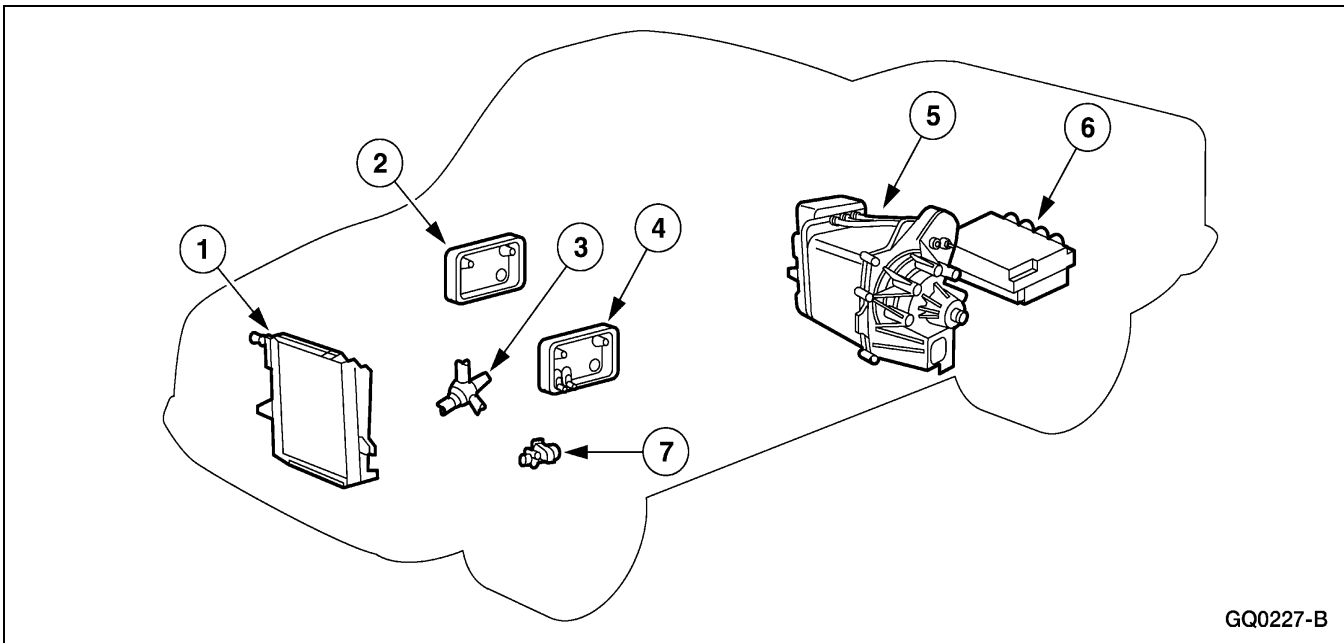

GQ0227-B

Item	Part Number	Description
1	—	Radiator
2	—	A/C Inverter Motor Controller
3	—	Coolant Temperature Sensor
4	—	Direct Current to Direct Current (DC/DC) Converter

Item	Part Number	Description
5	—	Motor/Transaxle
6	—	Traction Inverter Module (TIM)
7	—	Coolant Pump

(Continued)

**DESCRIPTION AND OPERATION (Continued)**

The cooling system removes heat from various electronic components. The coolant pump has a centrifugal impeller design with a 12-volt permanent magnet motor. The pump is used to circulate the coolant through the DC/DC module, motor/transaxle, and the traction inverter module (TIM). In an Electric Ranger equipped with air conditioning, coolant is also circulated through the A/C inverter motor controller. Because of the Electric Rangers unique systems, vehicle coolant is not used in the heating/defrosting system.

The interface adapter assembly (IAA) controls the operation of the electric coolant pump and the electric radiator fan, based upon vehicle coolant temperature. The IAA receives the temperature information from the coolant temperature sensor, which is located near the coolant pump. The pump circulates coolant through the vehicle using a combination of rubber hoses and metal tubing. The IAA energizes the pump whenever the ignition key is in the ON position and during traction battery charging if the DC/DC module is charging the auxiliary 12-volt battery. The electric fan is also controlled by the IAA. If the coolant temperature exceeds 40°C (104°F), the cooling fan runs at low speed. If the coolant temperature rises above 45°C (113°F), the cooling fan runs at high speed. The IAA turns the cooling fan off when the coolant temperature is less than 35°C (95°F). The IAA will also activate the fan during vehicle charging if the DC/DC module is charging the auxiliary battery, or when the air conditioning is operated.

**Cooling System —Postal Ranger EV**

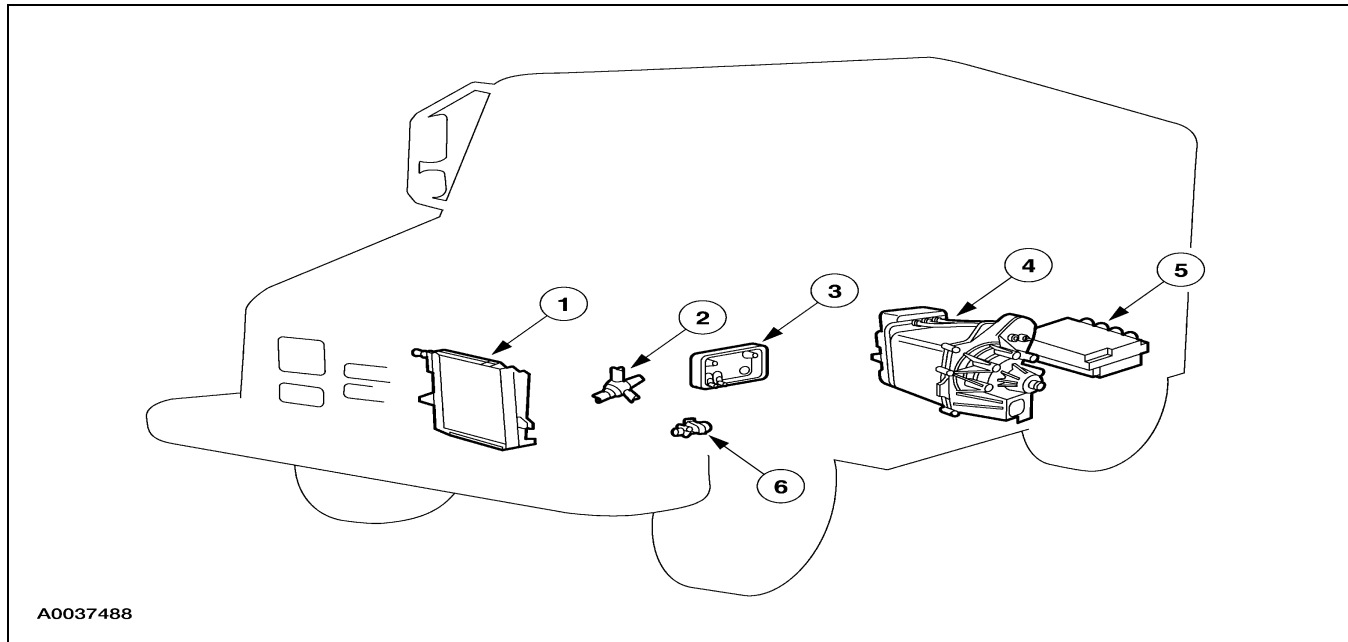

Item	Part Number	Description
1	—	Radiator
2	—	Coolant Temperature Sensor
3	—	Direct Current to Direct Current (DC/DC) Converter

Item	Part Number	Description
4	—	Motor/Transaxle
5	—	Traction Inverter Module (TIM)
6	—	Coolant Pump

(Continued)



## DESCRIPTION AND OPERATION (Continued)

The cooling system removes heat from various electronic components. The coolant pump has a centrifugal impeller design with a 12-volt permanent magnet motor. The pump is used to circulate the coolant through the DC/DC module, motor/transaxle, and the traction inverter module (TIM). Because of the Electric Rangers unique systems, vehicle coolant is not used in the heating/defrosting system.

The interface adapter assembly (IAA) controls the operation of the electric coolant pump and the electric radiator fan, based upon vehicle coolant temperature. The IAA receives the temperature information from the coolant temperature sensor, which is located near the coolant pump. The pump circulates coolant through the vehicle using a combination of rubber hoses and metal tubing. The IAA energizes the pump whenever the ignition key is in the ON position and during traction battery charging if the DC/DC module is charging the auxiliary 12-volt battery. The electric fan is also controlled by the IAA. If the coolant temperature exceeds 40°C (104°F), the cooling fan runs at low speed. If the coolant temperature rises above 45°C (113°F), the cooling fan runs at high speed. The IAA turns the cooling fan off when the coolant temperature is less than 35°C (95°F). The IAA will also activate the fan during vehicle charging if the DC/DC module is charging the auxiliary battery.

## DIAGNOSIS AND TESTING

### Cooling System

#### Diagnostic Trouble Code (DTC) Definition

The following DTC relates to the Cooling System:

- DTC C1774 Coolant Temperature Sensor Out of Range
  - The interface adapter assembly (IAA) module operates the radiator cooling fan based on coolant temperature. The IAA module uses the coolant temperature sensor to monitor the coolant temperature. The normal range of the coolant temperature sensor is between -40°C (-40°F) and 150°C (302°F). If the coolant temperature sensor is reading out of range, the IAA module sets DTC C1774.

#### Electrical Schematic

Refer to **Electrical and Vacuum Troubleshooting Manual, Cell 33, Cooling System** for schematic and connector information.

#### Inspection and Verification

g to [Section 100-07](#).

**DIAGNOSIS AND TESTING (Continued)****Symptom Chart****Symptom Chart**

<b>Condition</b>	<b>Possible Sources</b>	<b>Action</b>
<ul style="list-style-type: none"> <li>DTC C1774 Coolant Temperature Sensor Out of Range</li> </ul>	<ul style="list-style-type: none"> <li>Circuit(s).</li> <li>Coolant temperature sensor.</li> <li>Interface adapter assembly (IAA) module.</li> </ul>	<ul style="list-style-type: none"> <li>GO to <a href="#">Pinpoint Test A.</a></li> </ul>
<ul style="list-style-type: none"> <li>Coolant Pump Does Not Operate</li> </ul>	<ul style="list-style-type: none"> <li>Fuse.</li> <li>Circuit(s).</li> <li>Coolant pump.</li> <li>Interface adapter assembly (IAA) module.</li> </ul>	<ul style="list-style-type: none"> <li>GO to <a href="#">Pinpoint Test B.</a></li> </ul>
<ul style="list-style-type: none"> <li>Coolant Pump Runs With the Ignition Key in the OFF Position.</li> </ul>	<ul style="list-style-type: none"> <li>Circuit(s).</li> <li>Coolant pump relay.</li> <li>Interface adapter assembly (IAA) module.</li> </ul>	<ul style="list-style-type: none"> <li>GO to <a href="#">Pinpoint Test C.</a></li> </ul>
<ul style="list-style-type: none"> <li>Cooling Fan Does Not Operate</li> </ul>	<ul style="list-style-type: none"> <li>Fuse.</li> <li>Circuit(s).</li> <li>Cooling fan.</li> <li>Interface adapter assembly (IAA) module.</li> <li>Fan low speed relay.</li> <li>Fan high speed relay.</li> </ul>	<ul style="list-style-type: none"> <li>GO to <a href="#">Pinpoint Test D.</a></li> </ul>
<ul style="list-style-type: none"> <li>Cooling Fan Runs at Low Speed at All Times</li> </ul>	<ul style="list-style-type: none"> <li>Circuit(s).</li> <li>Fan low speed relay.</li> <li>Interface adapter assembly (IAA) module.</li> </ul>	<ul style="list-style-type: none"> <li>GO to <a href="#">Pinpoint Test E.</a></li> </ul>
<ul style="list-style-type: none"> <li>Cooling Fan Runs at High Speed at All Times</li> </ul>	<ul style="list-style-type: none"> <li>Circuit(s).</li> <li>Fan high speed relay.</li> <li>Interface adapter assembly (IAA) module.</li> </ul>	<ul style="list-style-type: none"> <li>GO to <a href="#">Pinpoint Test F.</a></li> </ul>

**Pinpoint Tests****Special Tool(s)**

104-Pin Breakout Box (BOB) 418-049 (014-00950) or equivalent

Dial Thermometer 023-R0007 or equivalent

**PINPOINT TEST A: DTC C1774 COOLANT TEMPERATURE SENSOR OUT OF RANGE**

<b>TEST STEP</b>	<b>ACTION TO TAKE</b>
<b>A1 CHECK COOLANT TEMPERATURE</b> <ul style="list-style-type: none"> <li>With key ON, monitor the interface adapter assembly (IAA) module PID CLNTTMP.</li> <li><b>Is the temperature between -40°C (-40°F) and 150°C (302°F)?</b></li> </ul>	Yes = GO to <b>A2</b> . No = GO to <b>A3</b> .
<b>A2 VERIFY COOLANT TEMPERATURE</b> <ul style="list-style-type: none"> <li>Remove the radiator pressure relief cap and use Dial Thermometer to measure the temperature of the coolant.</li> <li>Compare the actual coolant temperature to the IAA module PID CLNTTMP.</li> <li><b>Is the actual temperature within 10°C (50°F) of the IAA PID CLNTTMP?</b></li> </ul>	Yes = System OK. CHECK wiring for intermittent connections. No = GO to <b>A5</b> .

(Continued)

**DIAGNOSIS AND TESTING (Continued)****PINPOINT TEST A: DTC C1774 COOLANT TEMPERATURE SENSOR OUT OF RANGE**

<b>TEST STEP</b>	<b>ACTION TO TAKE</b>
<b>A3 CHECK CIRCUITS 3064 (BK/O) AND 3065 (LG/P) FOR OPEN(S)</b> <ul style="list-style-type: none"> <li>Connect 104-Pin Breakout Box (BOB) to IAA module C1945; leave IAA module disconnected.</li> <li>With key OFF, disconnect coolant temperature sensor C1966 and measure the resistance of the BK/O wire between BOB pin 70 and coolant temperature sensor C1966.</li> <li>With key OFF, measure the resistance between BOB pin 95 and coolant temperature sensor C1966.</li> <li><b>Are the resistances less than 5 ohms?</b></li> </ul>	Yes = GO to <b>A4</b> .  No = REPAIR the wire(s) in question.
<b>A4 CHECK CIRCUITS 3064 (BK/O) AND 3065 (LG/P) FOR SHORT(S) TO GROUND</b> <ul style="list-style-type: none"> <li>With key OFF, measure the resistance between BOB pins 70, 95, and ground (BOB pin 80).</li> <li><b>Are the resistances greater than 10,000 ohms?</b></li> </ul>	Yes = GO to <b>A5</b> .  No = REPAIR the wire(s) in question.
<b>A5 CHECK COOLANT TEMPERATURE SENSOR</b> <ul style="list-style-type: none"> <li>With key OFF, measure the resistance between the terminals of the coolant temperature sensor and compare the reading to the values below: <b>Actual Temperature (Approximate)</b> <ul style="list-style-type: none"> <li>—0 °C (32°F) = 91,000-100,700 ohms</li> <li>—5 °C (41°F) = 71,100-78,700 ohms</li> <li>—10 °C (50°F) = 56,000-62,000 ohms</li> <li>—15 °C (59°F) = 44,400-49,100 ohms</li> <li>—20 °C (68°F) = 37,300-39,200 ohms</li> <li>—25 °C (77°F) = 28,500-31,500 ohms</li> <li>—30 °C (86°F) = 23,000-25,500 ohms</li> <li>—35 °C (95°F) = 18,700-20,700 ohms</li> <li>—40 °C (104°F) = 15,300-16,900 ohms</li> <li>—45 °C (113°F) = 12,500-13,900 ohms</li> <li>—50 °C (122°F) = 10,300-11,500 ohms</li> <li>—55 °C (131°F) = 8,600-9,500 ohms</li> <li>—60 °C (140°F) = 7,100-7,900 ohms</li> </ul> </li> <li><b>Is the resistance OK?</b></li> </ul>	Yes = REPLACE the IAA module. REFER to <a href="#">Section 412-04</a> .  No = REPLACE the coolant temperature sensor.

**PINPOINT TEST B: COOLANT PUMP DOES NOT OPERATE**

<b>TEST STEP</b>	<b>ACTION TO TAKE</b>
<b>B1 CHECK FUSE AND POWER TO COOLANT PUMP RELAY</b> <ul style="list-style-type: none"> <li>Check 20A fuse 20 in the electric vehicle power distribution box (EVPDB).</li> <li>With key OFF, remove the coolant pump relay from the EVPDB and measure the voltage between pins 85, 87 on the coolant pump relay connector and ground. (V &gt; 10 volts)</li> <li><b>Is everything OK?</b></li> </ul>	Yes = RECONNECT the coolant pump relay. GO to <b>B2</b> .  No = REPAIR as necessary.
<b>B2 CHECK COOLANT PUMP</b> <ul style="list-style-type: none"> <li>Enter the interface adapter assembly (IAA) module active command mode CLIMATE SYSTEM CONTROL and set the active command PUMP/VBC to ON.</li> <li><b>Does the coolant pump operate?</b></li> </ul>	Yes = System OK. CHECK wiring for intermittent connections.  No = GO to <b>B3</b> .
<b>B3 CHECK POWER TO COOLANT PUMP</b>	

(Continued)

**DIAGNOSIS AND TESTING (Continued)****PINPOINT TEST B: COOLANT PUMP DOES NOT OPERATE**

TEST STEP	ACTION TO TAKE
<ul style="list-style-type: none"> <li>With key OFF, disconnect coolant pump C1998.</li> <li>Enter the IAA module active command mode CLIMATE SYSTEM CONTROL, set the active command PUMP/VBC to ON, and measure the voltage between the W/R wire and BK wire on coolant pump C1998.</li> <li><b>Is the voltage greater than 10 volts?</b></li> </ul>	Yes = REPLACE the coolant pump. No = GO to <b>B4</b> .
<b>B4 CHECK GROUND TO COOLANT PUMP</b> <ul style="list-style-type: none"> <li>With key OFF, measure the resistance between the BK wire on coolant pump C1998 and ground.</li> <li><b>Is the resistance less than 5 ohms?</b></li> </ul>	Yes = GO to <b>B5</b> . No = REPAIR the BK wire.
<b>B5 CHECK COOLANT PUMP RELAY CONTROL CIRCUIT</b> <ul style="list-style-type: none"> <li>With key OFF, remove the coolant pump relay from the EVPDB.</li> <li>Enter the IAA module active command mode CLIMATE SYSTEM CONTROL, set the active command PUMP/VBC to ON, and measure the resistance between pin 86 on the coolant pump relay connector and ground.</li> <li><b>Is the resistance less than 5 ohms?</b></li> </ul>	Yes = GO to <b>B7</b> . No = GO to <b>B6</b> .
<b>B6 CHECK CIRCUIT 3020 (LB) FOR OPEN</b> <ul style="list-style-type: none"> <li>Connect 104-Pin Breakout Box (BOB) to IAA module C1945; leave IAA module disconnected.</li> <li>With key OFF, measure the resistance of the LB wire between pin 86 on the coolant pump relay connector and BOB pin 19.</li> <li><b>Is the resistance less than 5 ohms?</b></li> </ul>	Yes = REPLACE the IAA module. REFER to <a href="#">Section 412-04</a> . No = REPAIR the LB wire.
<b>B7 CHECK CIRCUIT 3229 (W/R) FOR OPEN</b> <ul style="list-style-type: none"> <li>With key OFF, measure the resistance of the W/R wire between coolant pump C1998 and pin 30 on the coolant pump relay connector.</li> <li><b>Is the resistance less than 5 ohms?</b></li> </ul>	Yes = REPLACE the coolant pump relay. No = REPAIR the W/R wire.

**PINPOINT TEST C: COOLANT PUMP RUNS WITH THE IGNITION KEY IN THE OFF POSITION**

TEST STEP	ACTION TO TAKE
<b>C1 CHECK CIRCUIT 3229 (W/R) FOR SHORT TO POWER</b> <ul style="list-style-type: none"> <li>Remove the coolant pump relay from the electric vehicle power distribution box (EVPDB).</li> <li><b>Does the coolant pump stop running?</b></li> </ul>	Yes = GO to <b>C2</b> . No = REPAIR the W/R wire.
<b>C2 CHECK COOLANT PUMP RELAY</b> <ul style="list-style-type: none"> <li>Measure the resistance between terminals 30 and 87 on the coolant pump relay.</li> <li><b>Is the resistance less than 5 ohms?</b></li> </ul>	Yes = REPLACE the coolant pump relay. No = GO to <b>C3</b> .
<b>C3 CHECK CIRCUIT 3020 (LB) FOR SHORT TO GROUND</b> <ul style="list-style-type: none"> <li>With key OFF, disconnect interface adapter assembly (IAA) module C1945 and measure the resistance between pin 86 on the coolant pump relay connector and ground.</li> <li><b>Is the resistance greater than 10,000 ohms?</b></li> </ul>	Yes = REPLACE the IAA module. REFER to <a href="#">Section 412-04</a> . No = REPAIR the LB wire.

**PINPOINT TEST D: COOLING FAN DOES NOT OPERATE**

TEST STEP	ACTION TO TAKE
<b>D1 CHECK FUSE AND POWER TO FAN SPEED RELAYS</b> <ul style="list-style-type: none"> <li>Check 50A fuse 5 in the electric vehicle power distribution box (EVPDB).</li> </ul>	Yes = RECONNECT the fan speed relays. GO to <b>D2</b> .

(Continued)

**DIAGNOSIS AND TESTING (Continued)****PINPOINT TEST D: COOLING FAN DOES NOT OPERATE**

<b>TEST STEP</b>	<b>ACTION TO TAKE</b>
<ul style="list-style-type: none"> <li>With key OFF, remove the fan low speed relay from the cooling fan relay box and measure the voltage between pins 85, 87 on the fan low speed relay C1954 and ground. (V &gt; 10 volts)</li> <li>With key OFF, remove the fan high speed relay from the cooling fan relay box and measure the voltage between pins 2, 3 on the fan high speed relay C1955 and ground. (V &gt; 10 volts)</li> <li><b>Is everything OK?</b></li> </ul>	No = REPAIR as necessary.
<b>D2 CHECK LOW SPEED FAN OPERATION</b> <ul style="list-style-type: none"> <li>Enter the interface adapter assembly (IAA) module active command mode FAN SPEED CONTROL and set the active command FAN SPD to LOW.</li> <li><b>Does the cooling fan operate at low speed?</b></li> </ul>	Yes = GO to <b>D8</b> . No = GO to <b>D3</b> .
<b>D3 CHECK POWER TO COOLING FAN</b> <ul style="list-style-type: none"> <li>With key OFF, disconnect cooling fan C1967.</li> <li>Enter the IAA module active command mode FAN SPEED CONTROL, set the active command FAN SPD to LOW, and measure the voltage between the R/O wire and BK wire on cooling fan C1967.</li> <li><b>Is the voltage greater than 10 volts?</b></li> </ul>	Yes = REPLACE the cooling fan. No = GO to <b>D4</b> .
<b>D4 CHECK GROUND TO COOLING FAN</b> <ul style="list-style-type: none"> <li>With key OFF, measure the resistance between the BK wire on the cooling fan C1967 and ground.</li> <li><b>Is the resistance less than 5 ohms?</b></li> </ul>	Yes = GO to <b>D5</b> . No = REPAIR the BK wire.
<b>D5 CHECK FAN LOW SPEED RELAY CONTROL CIRCUIT</b> <ul style="list-style-type: none"> <li>With key OFF, remove the fan low speed relay from the cooling fan relay box.</li> <li>Enter the IAA module active command mode FAN SPEED CONTROL, set the active command FAN SPD to LOW, and measure the resistance between pin 86 on the fan low speed relay C1954 and ground.</li> <li><b>Is the resistance less than 5 ohms?</b></li> </ul>	Yes = GO to <b>D7</b> . No = GO to <b>D6</b> .
<b>D6 CHECK CIRCUIT 3828 (O/BK) FOR OPEN</b> <ul style="list-style-type: none"> <li>Connect 104-Pin Breakout Box (BOB) to IAA module C1945; leave IAA module disconnected.</li> <li>With key OFF, measure the resistance of the O/BK wire between pin 86 on the fan low speed relay C1954 and BOB pin 69.</li> <li><b>Is the resistance less than 5 ohms?</b></li> </ul>	Yes = REPLACE the IAA module. REFER to Section 412-04. No = REPAIR the O/BK wire.
<b>D7 CHECK CIRCUIT 260 (R/O) FOR OPEN</b> <ul style="list-style-type: none"> <li>With key OFF, measure the resistance of the R/O wire between cooling fan C1967 and pin 30 on the fan low speed relay C1954.</li> <li><b>Is the resistance less than 5 ohms?</b></li> </ul>	Yes = REPLACE the fan low speed relay. No = REPAIR the R/O wire.
<b>D8 CHECK HIGH SPEED FAN OPERATION</b> <ul style="list-style-type: none"> <li>Enter the IAA module active command mode FAN SPEED CONTROL and set the active command FAN SPD to HIGH.</li> <li><b>Does the cooling fan operate at high speed?</b></li> </ul>	Yes = System OK. CHECK wiring for intermittent connections. No = GO to <b>D9</b> .
<b>D9 CHECK POWER TO COOLING FAN</b> <ul style="list-style-type: none"> <li>With key OFF, disconnect cooling fan C1967.</li> <li>Enter the IAA module active command mode FAN SPEED CONTROL, set the active command FAN SPD to HIGH, and measure the voltage between the O/BK wire and BK wire on cooling fan C1967.</li> <li><b>Is the voltage greater than 10 volts?</b></li> </ul>	Yes = REPLACE the cooling fan. No = GO to <b>D10</b> .
<b>D10 CHECK GROUND TO COOLING FAN</b>	

(Continued)

**DIAGNOSIS AND TESTING (Continued)****PINPOINT TEST D: COOLING FAN DOES NOT OPERATE**

TEST STEP	ACTION TO TAKE
<ul style="list-style-type: none"> <li>With key OFF, measure the resistance between the BK wire on the cooling fan C1967 and ground.</li> <li><b>Is the resistance less than 5 ohms?</b></li> </ul>	Yes = GO to <b>D11</b> . No = REPAIR the BK wire.
<b>D11 CHECK FAN HIGH SPEED RELAY CONTROL CIRCUIT</b> <ul style="list-style-type: none"> <li>With key OFF, remove the fan high speed relay from the cooling fan relay box.</li> <li>Enter the IAA module active command mode FAN SPEED CONTROL, set the active command FAN SPD to HIGH, and measure the resistance between pin 1 on the fan high speed relay C1955 and ground.</li> <li><b>Is the resistance less than 5 ohms?</b></li> </ul>	Yes = GO to <b>D13</b> . No = GO to <b>D12</b> .
<b>D12 CHECK CIRCUIT 3829 (LB/BK) FOR OPEN</b> <ul style="list-style-type: none"> <li>Connect 104-Pin Breakout Box (BOB) to interface adapter assembly (IAA) module C1945; leave IAA module disconnected.</li> <li>With key OFF, measure the resistance of the LB/BK wire between pin 1 on the fan high speed relay C1955 and BOB pin 101.</li> <li><b>Is the resistance less than 5 ohms?</b></li> </ul>	Yes = REPLACE the IAA module. REFER to <a href="#">Section 412-04</a> . No = REPAIR the LB/BK wire.
<b>D13 CHECK CIRCUIT 261 (O/BK) FOR OPEN</b> <ul style="list-style-type: none"> <li>With key OFF, measure the resistance of the O/BK wire between cooling fan C1967 and pin 5 on the fan high speed relay C1955.</li> <li><b>Is the resistance less than 5 ohms?</b></li> </ul>	Yes = REPLACE the fan high speed relay. No = REPAIR the O/BK wire.

**PINPOINT TEST E: COOLING FAN RUNS AT LOW SPEED AT ALL TIMES**

TEST STEP	ACTION TO TAKE
<b>E1 CHECK CIRCUIT 260 (R/O) FOR SHORT TO POWER</b> <ul style="list-style-type: none"> <li>Remove the fan low speed relay from the cooling fan relay box.</li> <li><b>Does the cooling fan stop running?</b></li> </ul>	Yes = GO to <b>E2</b> . No = REPAIR the R/O wire.
<b>E2 CHECK FAN LOW SPEED RELAY</b> <ul style="list-style-type: none"> <li>Measure the resistance between terminals 30 and 87 on the fan low speed relay.</li> <li><b>Is the resistance less than 5 ohms?</b></li> </ul>	Yes = REPLACE the fan low speed relay. No = GO to <b>E3</b> .
<b>E3 CHECK CIRCUIT 3828 (O/BK) FOR SHORT TO GROUND</b> <ul style="list-style-type: none"> <li>With key OFF, disconnect interface adapter assembly (IAA) module C1945 and measure the resistance between pin 86 on the fan low speed relay C1954 and ground.</li> <li><b>Is the resistance greater than 10,000 ohms?</b></li> </ul>	Yes = REPLACE the IAA module. REFER to <a href="#">Section 412-04</a> . No = REPAIR the O/BK wire.

**PINPOINT TEST F: COOLING FAN RUNS AT HIGH SPEED AT ALL TIMES**

TEST STEP	ACTION TO TAKE
<b>F1 CHECK CIRCUIT 261 (O/BK) FOR SHORT TO POWER</b> <ul style="list-style-type: none"> <li>Remove the fan high speed relay from the cooling fan relay box.</li> <li><b>Does the cooling fan stop running?</b></li> </ul>	Yes = GO to <b>F2</b> . No = REPAIR the O/BK wire.
<b>F2 CHECK FAN HIGH SPEED RELAY</b> <ul style="list-style-type: none"> <li>Measure the resistance between terminals 3 and 5 on the fan high speed relay.</li> <li><b>Is the resistance less than 5 ohms?</b></li> </ul>	Yes = REPLACE the fan high speed relay. No = GO to <b>F3</b> .
<b>F3 CHECK CIRCUIT 3829 (LB/BK) FOR SHORT TO GROUND</b> <ul style="list-style-type: none"> <li>With key OFF, disconnect interface adapter assembly (IAA) module C1945 and measure the resistance between pin 1 on the fan high speed relay C1955 and ground.</li> <li><b>Is the resistance greater than 10,000 ohms?</b></li> </ul>	Yes = REPLACE the IAA module. REFER to <a href="#">Section 412-04</a> . No = REPAIR the LB/BK wire.

## GENERAL PROCEDURES

### Cooling System Drain, Fill and Bleed

#### Drain — Cooling System

1. Disconnect the auxiliary battery ground cable.

2.  **WARNING: Do not remove the radiator pressure relief cap if the coolant is hot or if the coolant pump is running.**

Remove the radiator pressure relief cap.

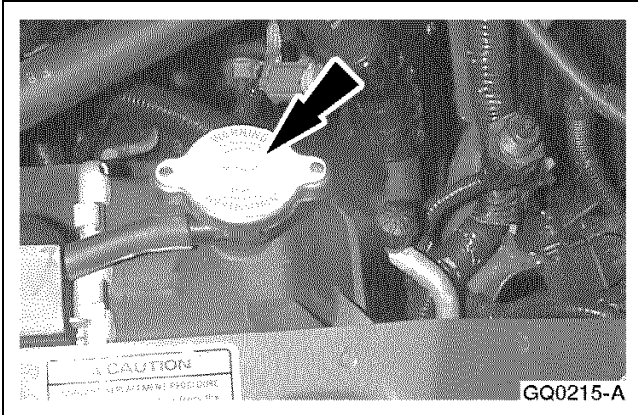

3. Raise and support the vehicle. Refer to [Section 100-02](#).

4. Position a catch pan under the radiator drain cock.

5. **NOTE:** This procedure will drain all coolant from the radiator, however, approximately 3.1 l (3.3 qt) of coolant will remain in the modules and coolant lines.

Open the radiator drain cock and drain the coolant from the radiator.

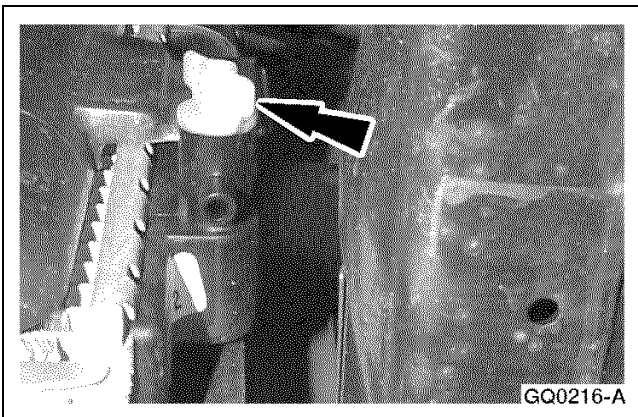

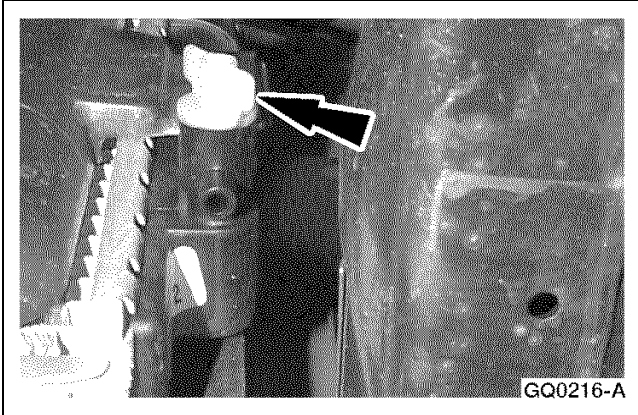
**GENERAL PROCEDURES (Continued)****Fill — Cooling System**

1. Close the radiator drain cock.

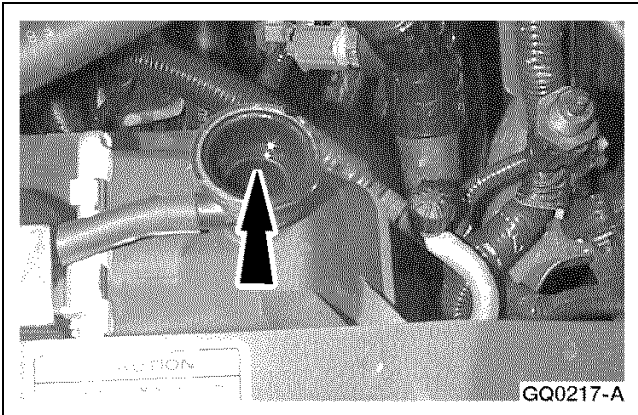

2. Lower the vehicle.
3. Add a 50/50 mix of Premium Cooling System Fluid E2FZ-19549-AA or equivalent meeting Ford specification ESE-M97B44-A and distilled water to the radiator until the coolant level reaches the bottom of the radiator filler neck.

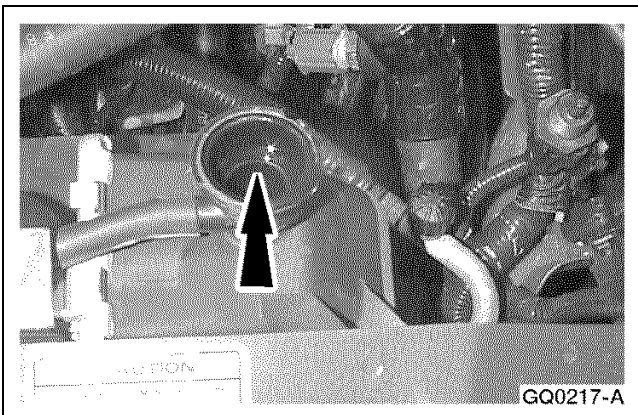

4. Fill the coolant reservoir with the 50/50 coolant mix until the coolant level reaches the cold fill line.
5. Turn the ignition key to the ON position to activate the coolant pump.
6. Add the 50/50 coolant mix to the radiator until the coolant level reaches the bottom of the radiator filler neck.

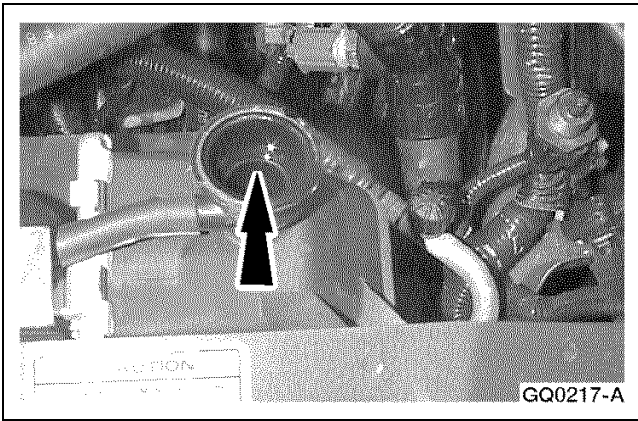
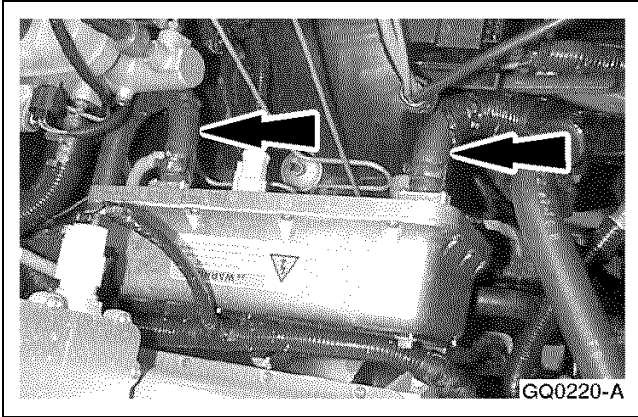

**GENERAL PROCEDURES (Continued)**

7. Alternately squeeze and hold the coolant hoses to the direct current/direct current (DC/DC) module and the hoses connecting to the underbody metal coolant tubes to make sure that coolant is flowing through all of the system.
8. Add the 50/50 coolant mix to the radiator until the coolant level reaches the bottom of the radiator filler neck.
9. Install the radiator pressure relief cap.
10. Turn the key to the OFF position to deactivate the coolant pump.
11. Slowly turn the pressure relief cap counterclockwise to the first stop, then retighten the cap. This forms a fluid link between the radiator and the overflow tank.

**Bleed —Cooling System**

1. Fill the coolant reservoir with a 50/50 mix of coolant meeting Ford specification ESE-M97B44-A and distilled water to the cold mark.
2. Remove the radiator pressure relief cap.
3. Turn the ignition key to the ON position to activate the water pump.

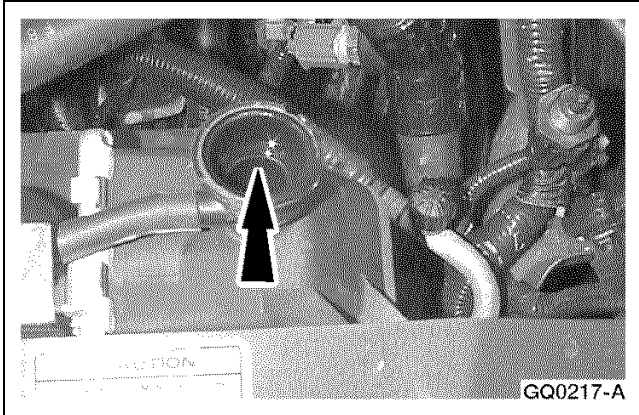
**GENERAL PROCEDURES (Continued)**

4. Add the 50/50 coolant mix to the radiator until the coolant level reaches the bottom of the radiator filler neck.

5. Install the radiator pressure relief cap.
6. Turn the key to the OFF position to deactivate the coolant pump.

**Purge —Cooling System**

1. **NOTE:** Under certain conditions, an air pocket can be formed in the coolant system at the coolant pump inlet. This causes the pump to stall, producing no coolant flow through the system. If the condition persists, the electronics can overheat, which produces an power limit or shut down conditions.

The solution for this is to bleed the air out of the highest point of the coolant lines. This line runs along the top of radio under the hood of the vehicle. The hose needs to be cut (which bleeds the air) between the two hose retainer clips, and needs to have a 3/4" hose splice installed and secured with two hose clamps. If a splice is already installed, one clamp can be loosened to slightly open the joint. That action will release enough air to allow the pump to prime. After bleeding the hose and securing it again, the radiator should be filled and the pump operated for 3-5 minutes, which will purge the remaining air pockets. This pump can be activated by turning the "ignition" key to the on position; (do not enable the vehicle). After that, install the radiator cap and put the proper amount of coolant in the overflow reservoir.

This procedure may be needed after certain coolant component changes. If the pump is running and coolant flowing, it is not necessary to do this procedure.

## REMOVAL AND INSTALLATION

### Coolant Pump

#### Removal

1. If connected, disconnect the vehicle from the charging station.
2. Disconnect the auxiliary battery ground cable.
3.  **CAUTION: Do not remove the radiator pressure relief cap if the coolant is hot or if the coolant pump is running.**

Turn the radiator pressure relief cap to the first stop to remove any remaining pressure.

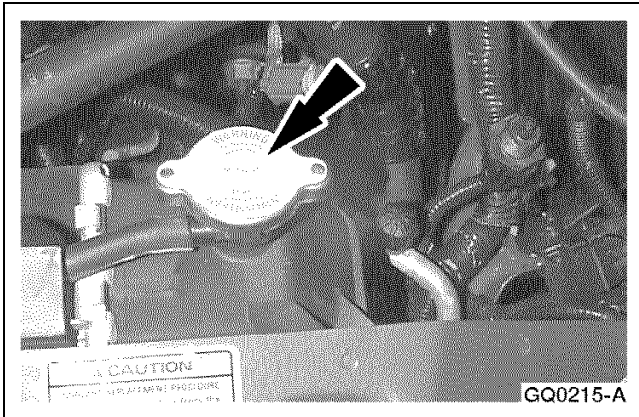

4. Raise and support the vehicle. Refer to [Section 100-02](#).
5. Remove the LH inner fender splash shield.
  - Disconnect the six clips.

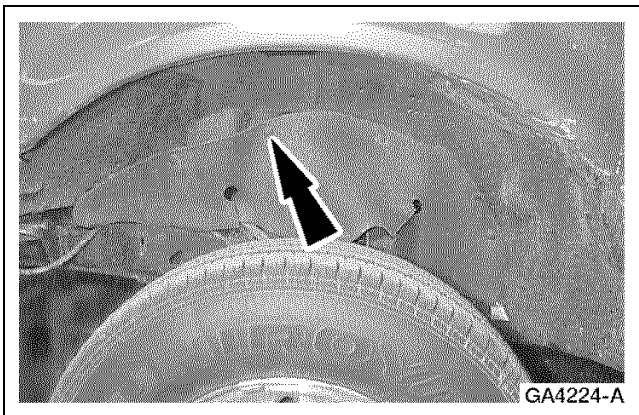

6. **NOTE:** When removing the water pump, it is preferable to clamp off the coolant lines rather than letting them drain.

Clamp off and disconnect the coolant lines from the water pump.

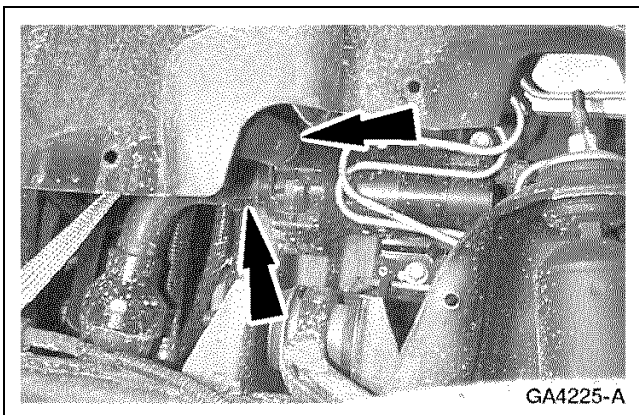

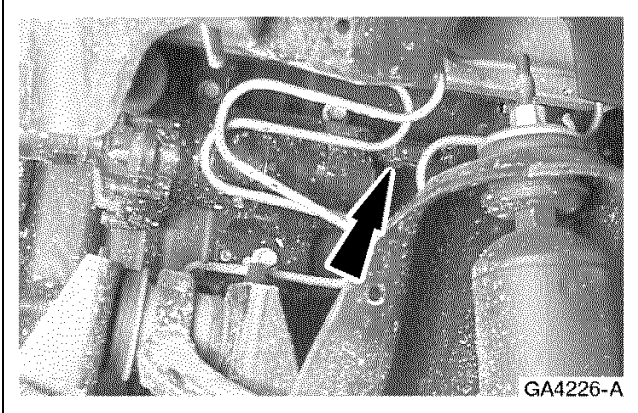
**REMOVAL AND INSTALLATION (Continued)**

7. Disconnect the coolant pump electrical connector.

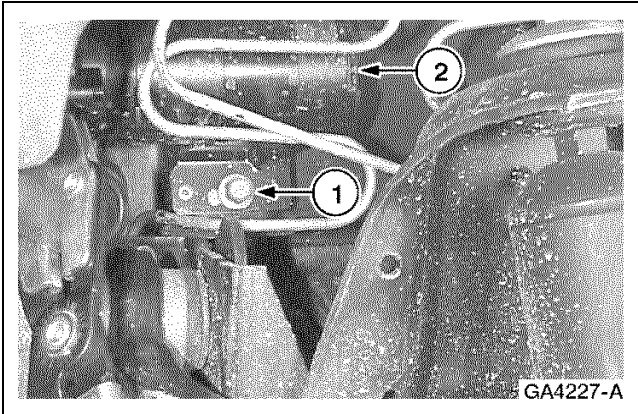

8. Remove the coolant pump.
  - 1 Remove the bolt.
  - 2 Remove the pump.

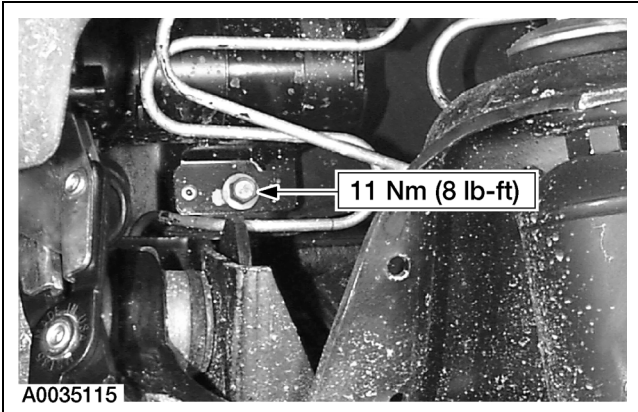
**Installation**

1. To install, reverse the removal procedure.
  - After installation, bleed the cooling system. Refer to [Cooling System Drain, Fill and Bleed](#)

**Coolant Pump —Postal Ranger EV****Removal**

1. If connected, disconnect the vehicle from the charging station.
2. Disconnect the auxiliary battery ground cable.

## REMOVAL AND INSTALLATION (Continued)

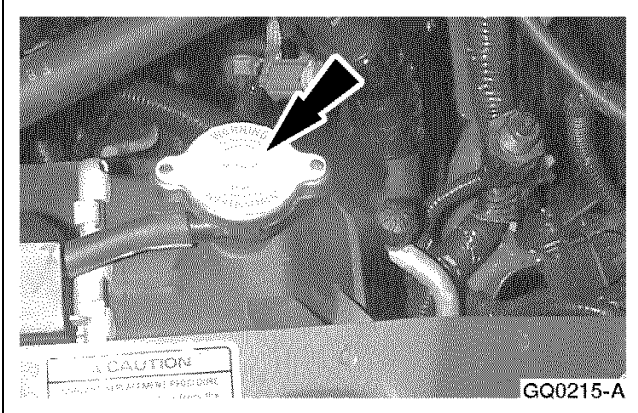

3. **⚠ CAUTION:** Do not remove the radiator pressure relief cap if the coolant is hot or if the coolant pump is running.

Turn the radiator pressure relief cap to the first stop to remove any remaining pressure.

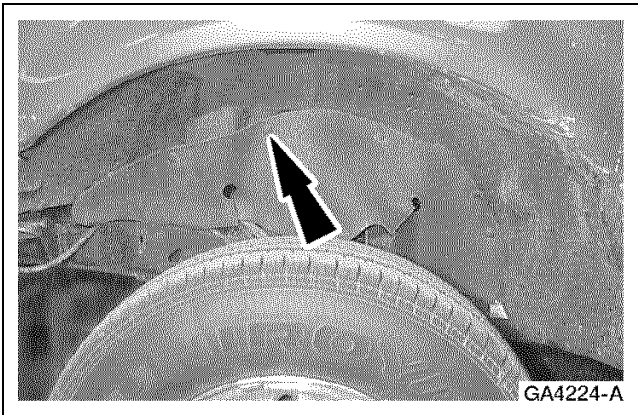

4. Raise and support the vehicle. Refer to [Section 100-02](#).
5. Remove the LH inner fender splash shield.

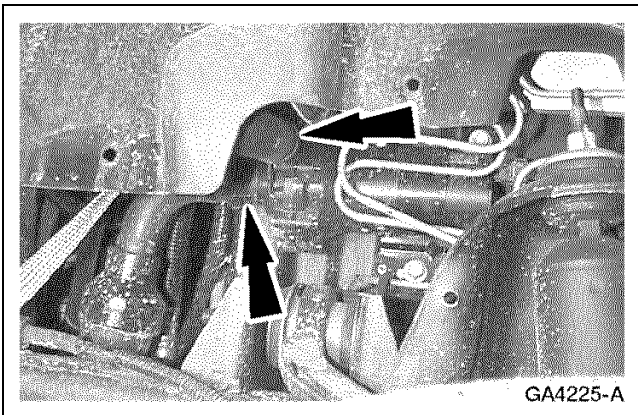

6. **NOTE:** When removing the water pump, it is preferable to clamp off the coolant lines rather than letting them drain.
- Clamp off and disconnect the coolant lines from the water pump.

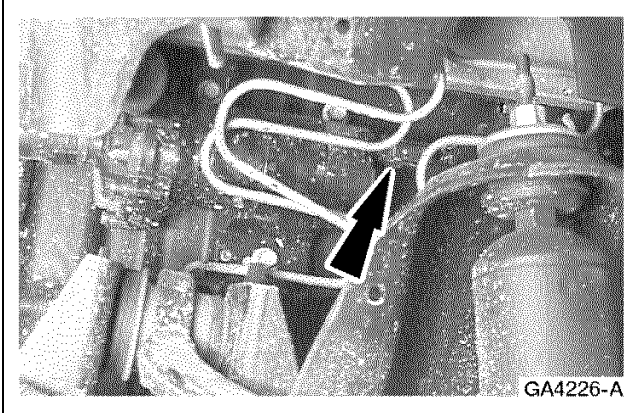
**REMOVAL AND INSTALLATION (Continued)**

7. Disconnect the coolant pump electrical connector.

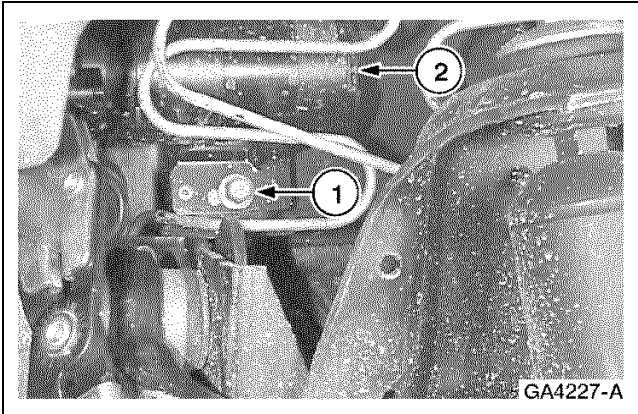

8. Remove the coolant pump.
  - 1 Remove the bolt.
  - 2 Remove the coolant pump.

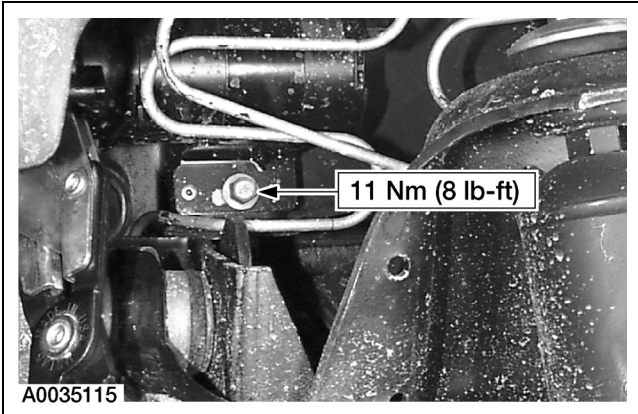
**Installation**

1. To install, reverse the removal procedure.
  - After installation, bleed the cooling system. Refer to [Cooling System Drain, Fill and Bleed](#)

**Cooling Fan****Removal**

1. Disconnect the auxiliary battery ground cable.

## REMOVAL AND INSTALLATION (Continued)

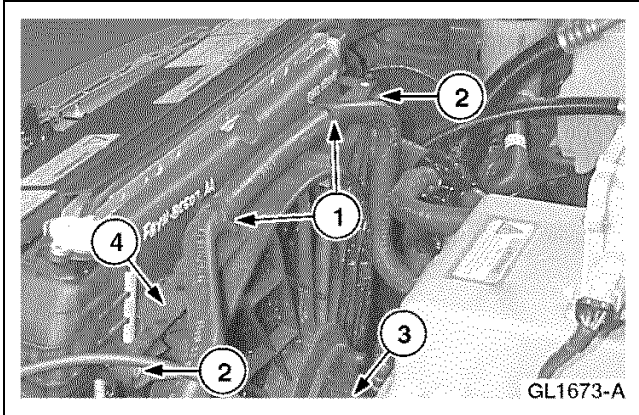

2. Remove the radiator cooling fan.
  - 1 Unclip the hose.
  - 2 Remove the two bolts.
  - 3 Disconnect the cooling fan electrical connector.
  - 4 Remove the radiator fan.

### Installation

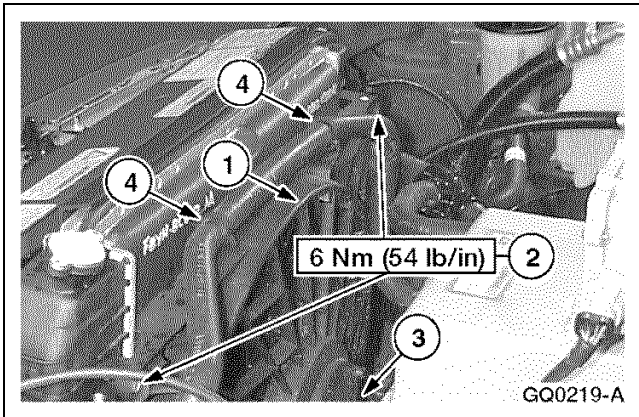

1. Install the radiator cooling fan.
  - 1 Position the cooling fan.
  - 2 Install the two bolts.
  - 3 Connect the cooling fan electrical connector.
  - 4 Clip the hose in position.

2. Connect the auxiliary battery ground cable.

## Cooling System Tubes and Hoses

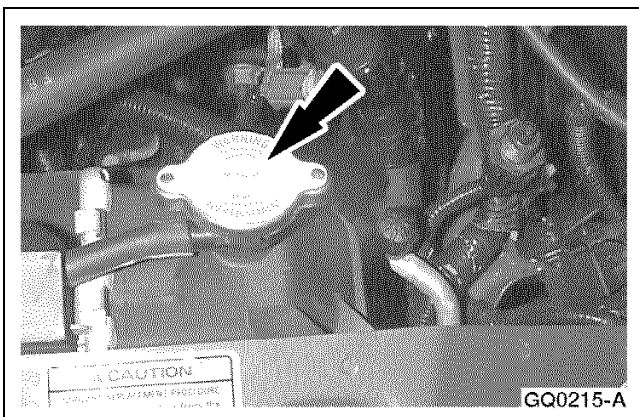

### Removal

1.  **CAUTION: Do not remove the radiator pressure relief cap if the coolant is hot or if the coolant pump is running.**

Turn the radiator pressure relief cap to the first stop to remove any remaining pressure.

2. Raise and support the vehicle. Refer to [Section 100-02](#).

## REMOVAL AND INSTALLATION (Continued)

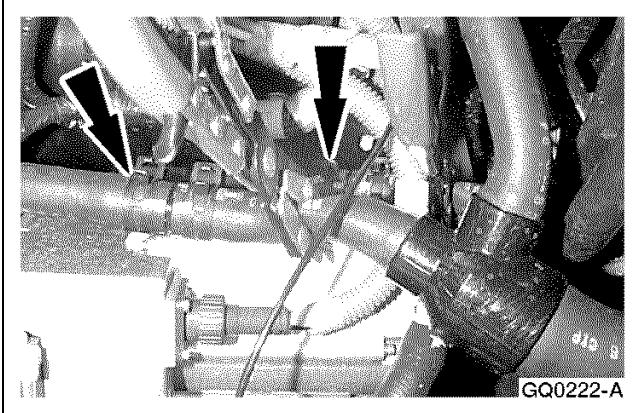

3. Disconnect the front coolant tube rubber hose connections.
  - Clamp off the hoses to prevent coolant loss.
  - Position a catch pan to collect the coolant.

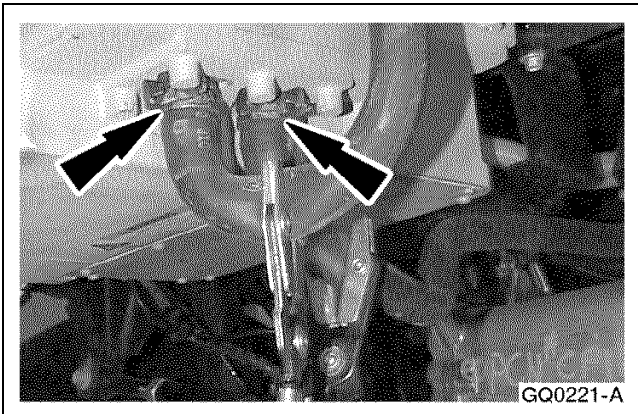

4. Disconnect the rear coolant tube rubber hose connections.
  - Clamp off the hoses to prevent coolant loss.
  - Position a catch pan to collect the coolant.

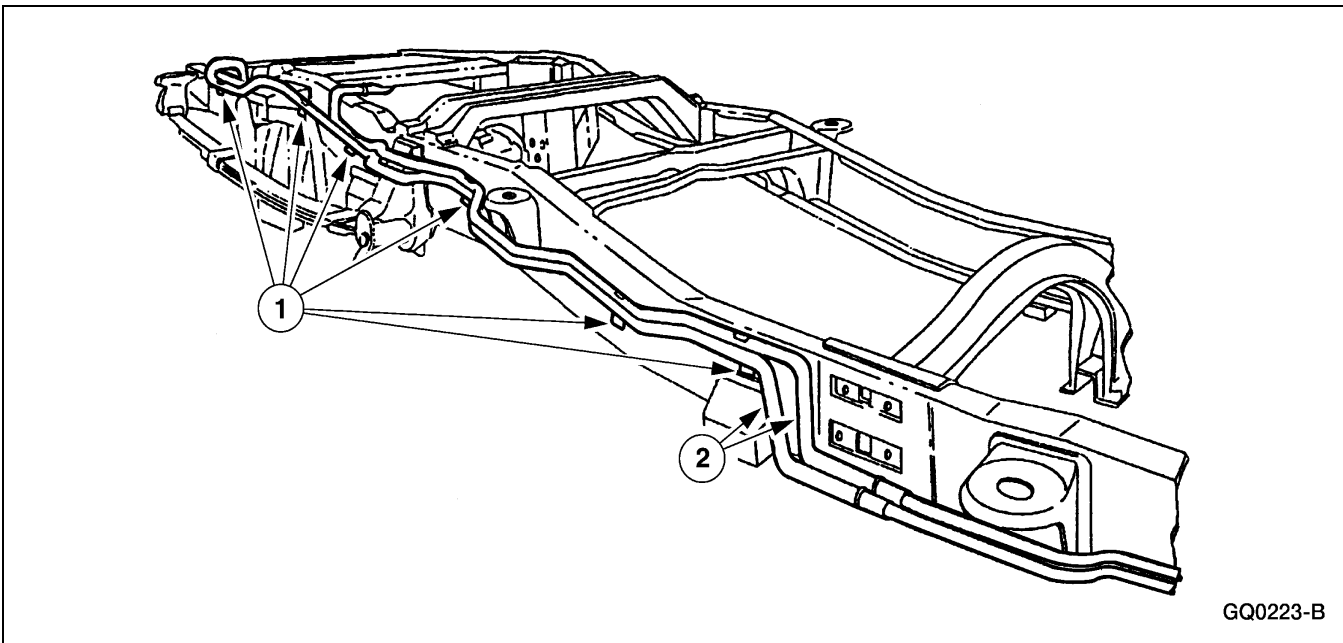

5. Remove the coolant tubes.
  - 1 Remove the eight coolant tube clamp screws.
  - 2 Remove the tubes.



## REMOVAL AND INSTALLATION (Continued)

### Installation

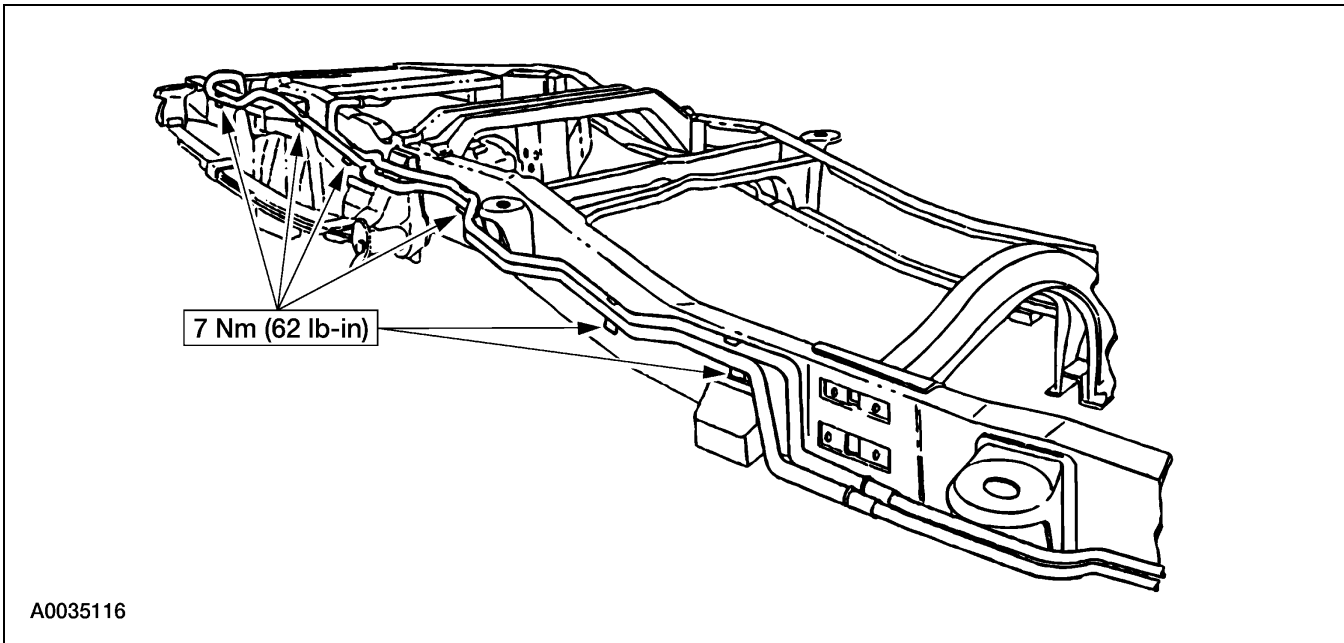

1. To install, reverse the removal procedure.
  - After installation, bleed the cooling system. Refer to [Bleed —Cooling System](#).

## Cooling System Tubes and Hoses —Postal Ranger EV

### Removal

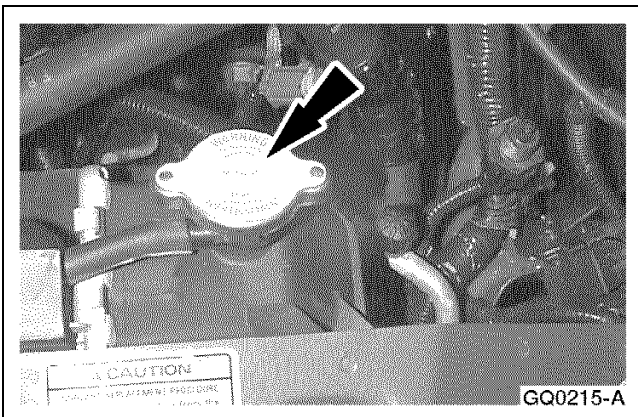

1. **⚠ WARNING: Do not remove the radiator pressure relief cap if the coolant is hot or if the coolant pump is running.**  
Turn the radiator pressure relief cap to the first stop to remove any remaining pressure.
2. Raise and support the vehicle. Refer to [Section 100-02](#).

## REMOVAL AND INSTALLATION (Continued)

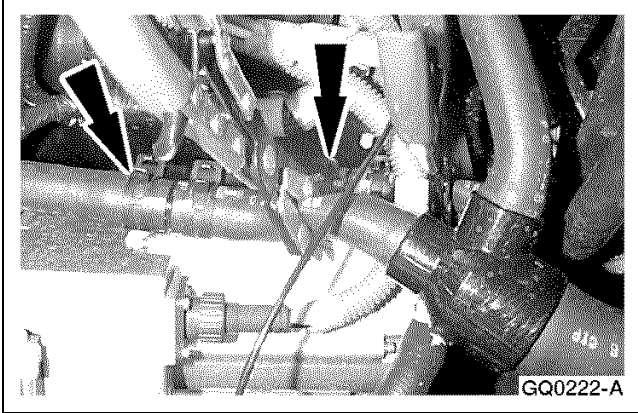

3. Disconnect the front coolant tube rubber hose connections.
  - Clamp off the hoses to prevent coolant loss.
  - Position a catch pan to collect the coolant.

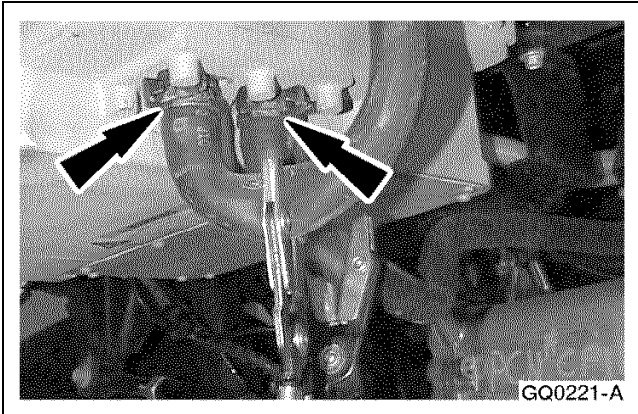

4. Disconnect the rear coolant tube rubber hose connections.
  - Clamp off the hoses to prevent coolant loss.
  - Position a catch pan to collect the coolant.

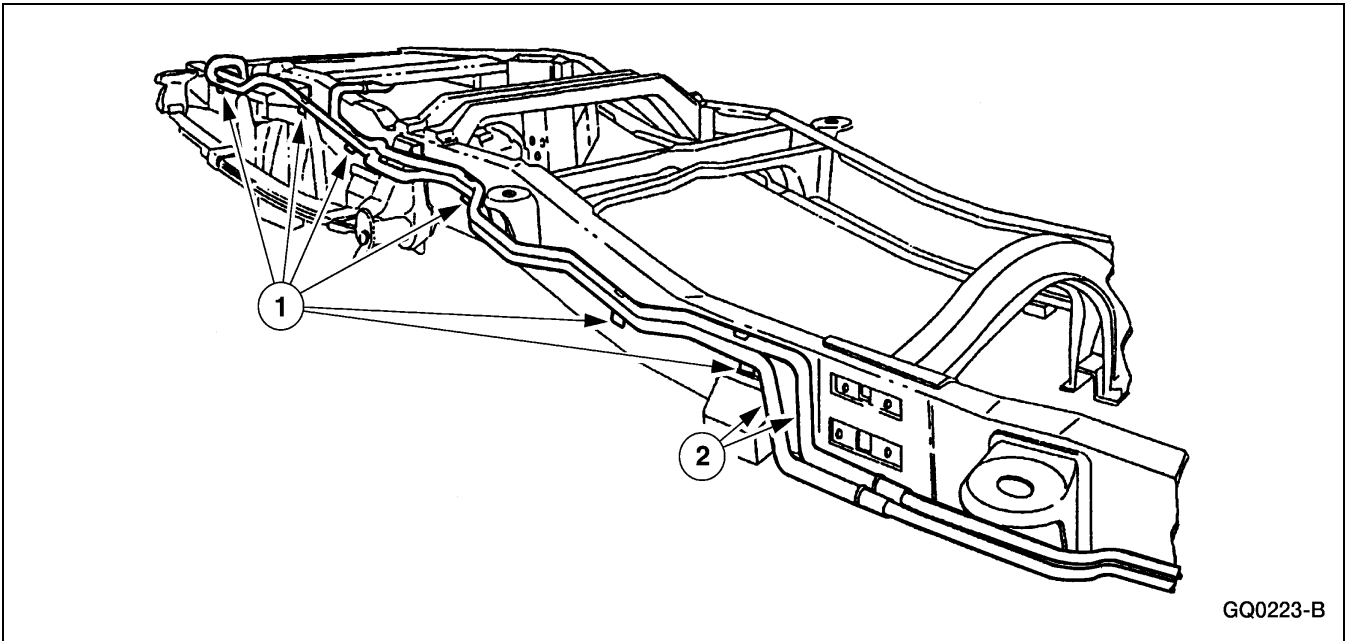

5. Remove the coolant tubes.
  - 1 Remove the seven coolant tube clamp screws.
  - 2 Remove the coolant tubes.

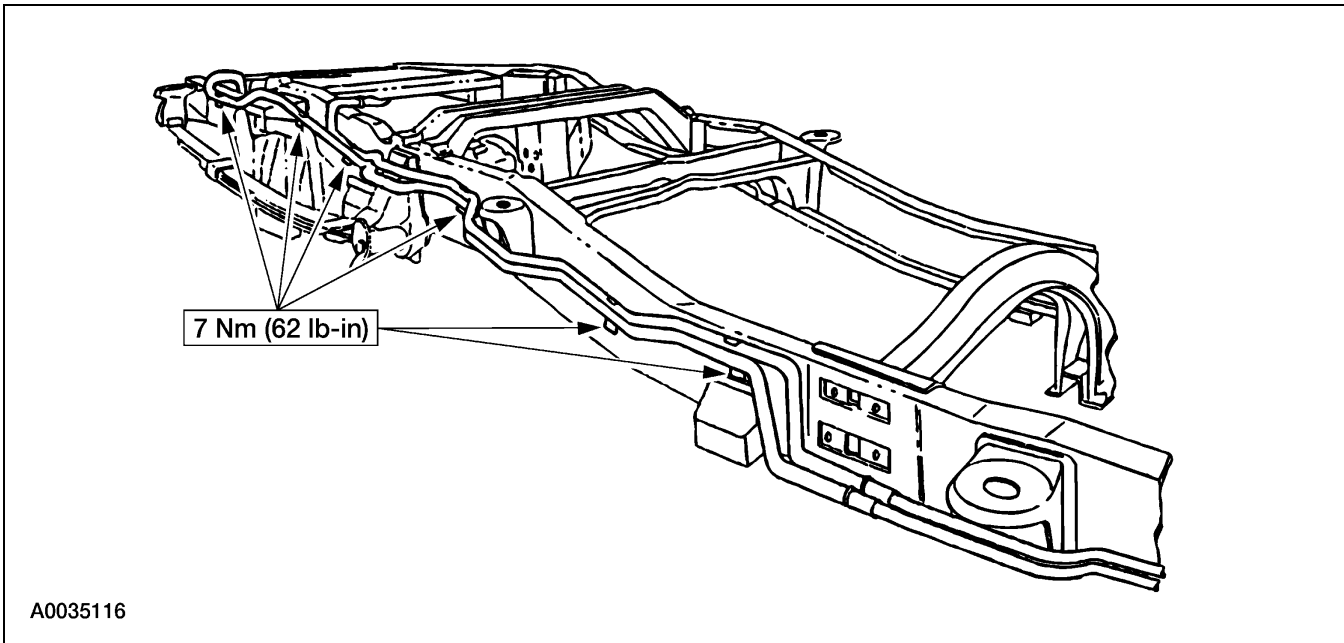
**REMOVAL AND INSTALLATION (Continued)****Installation**

A0035116

1. To install, reverse the removal procedure.
  - After installation, bleed the cooling system. Refer to [Cooling System Drain, Fill and Bleed](#).

Manual Table of Contents

# SECTION 303-14 Electric Motor Management

VEHICLE APPLICATION: Ranger EV

CONTENTS	PAGE
<b>SPECIFICATIONS</b> .....	303-14-2
<b>DESCRIPTION AND OPERATION</b>	
Electric Motor Management .....	303-14-2
<b>DIAGNOSIS AND TESTING</b>	
Traction Inverter Module (TIM) Control System .....	303-14-2
Electrical Schematic .....	303-14-2
Inspection and Verification .....	303-14-3
Pinpoint Test .....	303-14-3
Symptom Chart .....	303-14-3
<b>REMOVAL AND INSTALLATION</b>	
Traction Inverter Module (TIM).....	303-14-6

## SPECIFICATIONS

### Torque Specifications

Description	Nm	Lb-Ft	Lb-In
Ground Strap Bolt	12	—	107
TIM Bracket Bolts	20	14.5	—
TIM Bracket to Frame Bolts	22	16	—
TIM Cover Plate Screws	5	—	44.5
TIM A, B, C Cable Sleeve Nuts	3	—	26
TIM A,- Cable Connector Nuts	15	11	—

(Continued)

### Torque Specifications

Description	Nm	Lb-Ft	Lb-In
TIM B,+ Cable Connector Nuts	30	22	—
TIM C Cable Connector Nut	20	14.5	—
TIM +,- Cable Sleeve Nuts	5	—	44.5
TIM Electrical Connectors	3	—	26.5
TIM Mounting Bolts	22	16	—

## DESCRIPTION AND OPERATION

### Electric Motor Management

Electric motor management is accomplished by the traction inverter module (TIM). The TIM is located in the rear of the vehicle under the bed of the truck. The TIM converts high-voltage direct current from the traction battery into high-voltage, three-phase alternating current to power the motor/transaxle. Output from the TIM to the motor/transaxle is based upon driver, sensor, and other module inputs.

## DIAGNOSIS AND TESTING

### Traction Inverter Module (TIM) Control System

#### Diagnostic Trouble Code (DTC) Definition

The following DTCs relate to the traction inverter module (TIM) control system:

- DTC C1854 Motor Temperature Out of Range
  - The traction motor contains a temperature sensor in its stator field windings to indicate the motor temperature. The TIM uses this input signal to determine current sinked and sourced to the motor. DTC C1854 is set if the signal is out of the normal range of 0.8 to 4.0 volts. If this failure occurs, the malfunction indicator lamp (MIL), red brake warning indicator, and power limit warning indicator illuminate, and the TIM operates the motor at reduced power.
- DTC C1856 Traction Motor Encoder Circuit Failure
  - The traction motor contains two vehicle speed sensors (encoders) to provide two signals (channels A and B) to indicate the speed and direction of the vehicle to the TIM. At speeds greater than 16 km/h (10 mph), only one signal is used to indicate speed. If one signal fails, the other one will be used. Below 16 km/h (10 mph), both signals are needed to determine direction. If one signal fails, DTC C1856 is set and the vehicle shuts down. The TIM also uses the vehicle speed signal to calculate the output to the speedometer.

#### Electrical Schematic

Refer to **Electrical and Vacuum Troubleshooting Manual, Cell 26, Motor/Transaxle Control** for schematic and connector information.

**DIAGNOSIS AND TESTING (Continued)**

**Inspection and Verification**

Refer to [Section 100-07](#).

**Symptom Chart**

**Symptom Chart**

Condition	Possible Sources	Action
<ul style="list-style-type: none"> <li>DTC C1854 Motor Temperature Out of Range</li> </ul>	<ul style="list-style-type: none"> <li>Motor/transaxle.</li> <li>Circuit(s).</li> <li>Traction inverter module (TIM).</li> </ul>	<ul style="list-style-type: none"> <li>GO to <a href="#">Pinpoint Test A</a>.</li> </ul>
<ul style="list-style-type: none"> <li>DTC C1856 Traction Motor Encoder Circuit Failure</li> </ul>	<ul style="list-style-type: none"> <li>Motor/transaxle.</li> <li>Traction inverter module (TIM).</li> <li>Circuit(s).</li> </ul>	<ul style="list-style-type: none"> <li>GO to <a href="#">Pinpoint Test B</a>.</li> </ul>

**Pinpoint Test**

**Special Tool(s)**

104-Pin Breakout Box (BOB) 418-049 (014-00950) or equivalent
BCM/TIM Breakout Box (BOB) Adapter Cable 418-F212
BCM/TIM Breakout Box (BOB) Overlay 418-F220
Electric Motor/Transaxle Test Box 418-F211

**PINPOINT TEST A: DTC C1854 MOTOR TEMPERATURE OUT OF RANGE**

TEST STEP	ACTION TO TAKE
<p><b>A1 CHECK MOTOR TEMPERATURE SENSOR</b></p> <ul style="list-style-type: none"> <li>Monitor the motor PID TRNTEMP and note the temperature.</li> <li>With key OFF, disconnect motor/transaxle C4993 and connect the Electric Motor/Transaxle Test Box.</li> <li>Measure the resistance between the motor temperature ports on the test box and determine the motor temperature from the following resistance values below:</li> </ul> <p><b>Resistances</b></p> <ul style="list-style-type: none"> <li>—493 ohms=493 °C (32°F)</li> <li>—533 ohms=0 °C (32°F)</li> <li>—576 ohms=10 °C (50°F)</li> <li>—598 ohms=20 °C (68°F)</li> <li>—668 ohms=30 °C (104°F)</li> <li>—718 ohms=50 °C (122°F)</li> <li>—769 ohms=60 °C (140°F)</li> <li>—824 ohms=70 °C (158°F)</li> <li>—880 ohms=80 °C (176°F)</li> <li>—939 ohms=90 °C (194°F)</li> <li>—1000 ohms=100 °C (212°F)</li> <li>—1063 ohms=110 °C (230°F)</li> <li>—1129 ohms=120 °C (248°F)</li> <li>—1197 ohms=130 °C (266°F)</li> <li>—1268 ohms=140 °C (284°F)</li> </ul>	<p>Yes = GO to <b>A3</b>.</p>

(Continued)

**DIAGNOSIS AND TESTING (Continued)****PINPOINT TEST A: DTC C1854 MOTOR TEMPERATURE OUT OF RANGE**

TEST STEP	ACTION TO TAKE
<p>—1340 ohms=150 °C (302°F)</p> <ul style="list-style-type: none"> <li>• Is the TRNTEMP PID approximately equal to the resistance readings from the motor temperature test box?</li> </ul>	<p>No = GO to <b>A2</b>.</p>
<p><b>A2 VERIFY THE MEASURED RESISTANCE/TEMPERATURE IS IN RANGE</b></p> <ul style="list-style-type: none"> <li>• Note the measured resistance in test step A1</li> <li>• Is the resistance within the range indicated in the table test step A1?</li> </ul>	<p>Yes = GO to <b>A3</b>.</p> <p>No = REPLACE the motor/transaxle. REFER to <a href="#">Section 303-01</a>.</p>
<p><b>A3 CHECK CIRCUITS 3708 (BR) AND 3757 (BK/W) FOR OPEN(S)</b></p> <ul style="list-style-type: none"> <li>• Connect 104-Pin Breakout Box (BOB) to TIM C4998, C4999 using the BCM/TIM BOB Adapter Cable Overlay; leave the TIM disconnected.</li> <li>• With key OFF, measure the resistance of the (BR) wire between pin 5 on the motor/transaxle C4993 and BOB pin A2.</li> <li>• With key OFF, measure the resistance of the (BK/W) wire between pin 2 on the motor transaxle C4993 and BOB pin A11.</li> <li>• Are the resistances less than 5 ohms?</li> </ul>	<p>Yes = Go to <b>A4</b>.</p> <p>No = REPAIR the wire(s) in question.</p>
<p><b>A4 CHECK CIRCUITS 3708 (BR) AND 3757 (BK/W) FOR SHORT(S) TO POWER</b></p> <ul style="list-style-type: none"> <li>• With key ON, measure the voltage between BOB pins A2, A11 and ground (BOB pin A29).</li> <li>• Is the outside/recirculation door in the recirculation position?</li> </ul>	<p>Yes = REPAIR the wire(s) in question.</p> <p>No = GO to <b>A5</b>.</p>
<p><b>A5 CHECK CIRCUITS 3708 (BR) FOR SHORT TO GROUND</b></p> <ul style="list-style-type: none"> <li>• With key OFF, measure the resistance between BOB pins A2 and ground (BOB pin A29)</li> <li>• Is the resistance greater than 10,000 ohms?</li> </ul>	<p>Yes = GO to <b>A6</b>.</p> <p>No = REPAIR the (BR) wire.</p>
<p><b>A6 CHECK TIM AND TRANSAXLE TEMP. SENSE CIRCUIT FOR INTERMITTENT OPEN/SHORT</b></p> <p> <b>CAUTION:</b> If the vehicle is operated on a hoist, set up a safety perimeter around the vehicle using the safety cones and keep away from moving wheels and shafts.</p> <ul style="list-style-type: none"> <li>• With the Breakout Box installed, reconnect the TIM. With the key ON, monitor the voltage between the circuit 3708 (BR) BOB pin A2 and circuit 3757 (BK/W) BOB pin A11. This will allow monitoring of the voltage drop across the temperature sensor resistor in the transaxle. The temp. sensor in the transaxle is connected to a 5.0V reference voltage from the TIM. The voltage across the transaxle temp. sensor should be between 0.8V and 4.0V, depending on the temperature. To recreate the fault it may be necessary to lift the vehicle on a hoist and operate the vehicle in-gear to heat up the TIM and transaxle.</li> <li>• Is the voltage between 0.8 and 4.0V?</li> </ul>	<p>Yes = CONTINUE to monitor. Call the National Hotline 1-800-826-4694 for further instructions.</p> <p>No = If the voltage is between 4.9 and 5.1V, Go to <b>A7</b>. If the voltage is 0V, GO to <b>A8</b>.</p>
<p><b>A7 CHECK FOR OPEN IN TRANSAXLE TEMP. SENSOR</b></p>	

(Continued)

**DIAGNOSIS AND TESTING (Continued)****PINPOINT TEST A: DTC C1854 MOTOR TEMPERATURE OUT OF RANGE**

TEST STEP	ACTION TO TAKE
<ul style="list-style-type: none"> <li>With key OFF, measure the resistance of the Y/LG wire between pin 8 on in-line C2999 and BOB pin 35.</li> <li><b>Is the voltage between circuit 3708 (BR) and circuit 3757 (BK/W) between 4.9 and 5.0V and is the MIL and the Power Limit light on?</b></li> </ul>	Yes = Transaxle temp sensor is OPEN.  No = REPLACE the transaxle
<b>A8 CHECK FOR TRANSAXLE TEMP SENSOR SHORT TO GROUND</b> <ul style="list-style-type: none"> <li>Disconnect connector C4993 from the transaxle.</li> <li><b>Does the voltage remain at 0V?</b></li> </ul>	Yes = REPLACE the TIM. No = REPLACE the transaxle.

**PINPOINT TEST B: DTC 1856 TRACTION MOTOR ENCODER CIRCUIT FAILURE**

TEST STEP	ACTION TO TAKE
<b>B1 CHECK VEHICLE SPEED SENSORS</b> <ul style="list-style-type: none"> <li>With key OFF. Disconnect motor/transaxle C4993.</li> <li>Connect Electric Motor/Transaxle Test Box to the motor/transaxle and cigar lighter socket.</li> <li>Place the gear selector in the NEUTRAL position and raise the vehicle on a hoist.</li> <li>Set the vehicle speed sensor power switch on the test box to the ON position and manually rotate the rear wheels.</li> <li><b>Do the channel A and B LEDS on the test box blink alternately as the wheels rotate?</b></li> </ul>	Yes = GO to <b>B2</b> .  No = REPLACE the motor/transaxle. REFER to <a href="#">Section 303-01</a> .
<b>B2 CHECK VEHICLE SPEED SENSORS REFERENCE VOLTAGE</b> <ul style="list-style-type: none"> <li>Key OFF.</li> <li>Connect 104-pin Breakout Box (BOB) to traction inverter module (TIM) and TIM C4998, C4999 using the BCM/TIM BOB Adapter Cable and Overlay.</li> <li>With key ON, measure the voltage between BOB pin A30 and ground (BOB pin A29).</li> <li><b>Is the voltage greater than 10 volts?</b></li> </ul>	Yes = GO to <b>B3</b> .  No = REPLACE the TIM.
<b>B3 CHECK CIRCUITS 3707 (O), 3659 (BK/PK), 3700 (LB/R), AND 3701 (DB/W) FOR OPEN(S)</b> <ul style="list-style-type: none"> <li>With key OFF, disconnect the TIM from the BOB; leave BOB connected to TIM C4998, C4999.</li> <li>With key OFF, measure the resistance of the (O) wire between pin 8 on the motor/transaxle C4993 and BOB pin A30.</li> <li>With key OFF, measure the resistance of the (BK/PK) wire between pin 9 on the motor/transaxle C4993 and BOB pin A40.</li> <li>With key OFF, measure the resistance of the (LB/R) wire between pin 4 on the motor/transaxle C4993 and BOB pin A36.</li> <li>With key OFF, measure the resistance of the (DB/W) wire between pin 1 on the motor/transaxle C4993 and BOB pin A26.</li> <li><b>Is the voltage greater than 0 volts?</b></li> </ul>	Yes = GO to <b>B4</b> .  No = REPAIR the wire(s) in question.
<b>B4 CHECK CIRCUITS 3700 (LB/R) AND 3701 (DB/W) FOR SHORT(S) TO GROUND</b> <ul style="list-style-type: none"> <li>With key OFF, measure the resistance between BOB pins A26, A36 and ground (BOB pin A29).</li> <li><b>Are the resistances greater than 10,000 ohms?</b></li> </ul>	Yes = GO to <b>B5</b> .  No = REPAIR the wire(s) in question.

(Continued)



**DIAGNOSIS AND TESTING (Continued)****PINPOINT TEST B: DTC 1856 TRACTION MOTOR ENCODER CIRCUIT FAILURE**

TEST STEP	ACTION TO TAKE
<b>B5 CHECK CIRCUITS 3700 (LB/R) AND 3701 (DB/W) FOR SHORT(S) TO POWER</b> <ul style="list-style-type: none"> <li>• With key On, measure the voltage between BOB pins A26, A36 and ground (BOB pin A29).</li> <li>• Are any of the voltages greater than 0 volts?</li> </ul>	Yes = REPAIR the wire(s) in question. No = REPLACE the TIM.

**REMOVAL AND INSTALLATION****Traction Inverter Module (TIM)****Removal**

1.  **WARNING: The TIM contains capacitors which can retain a high-voltage charge even after the traction battery has been disconnected. Wear high-voltage insulated safety gloves and a faceshield during capacitor discharging. Ensure that the capacitors are completely discharged before continuing this procedure. Failure to do so may result in personal injury or death.**

Discharge the traction inverter module capacitors. Refer to [Section 100-05](#).

2. Disconnect the TIM cables.
  - 1 Remove the nuts.
  - 2 Remove the sleeve nuts and slide the cables out of the TIM.

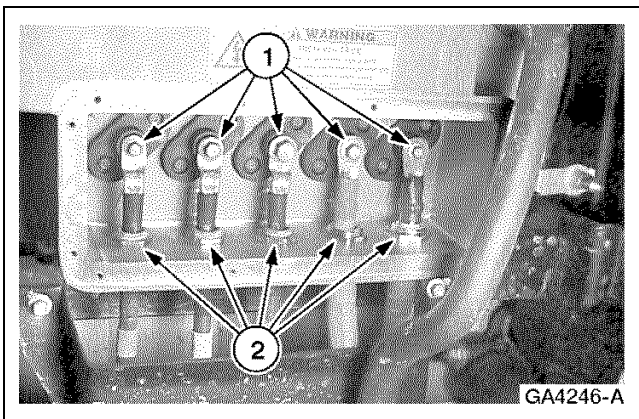

## REMOVAL AND INSTALLATION (Continued)

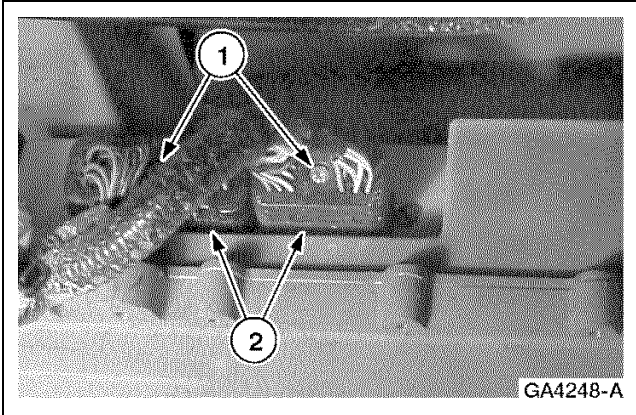

3. Disconnect the electrical connectors.
  - 1 Loosen the bolts.
  - 2 Disconnect the connectors.

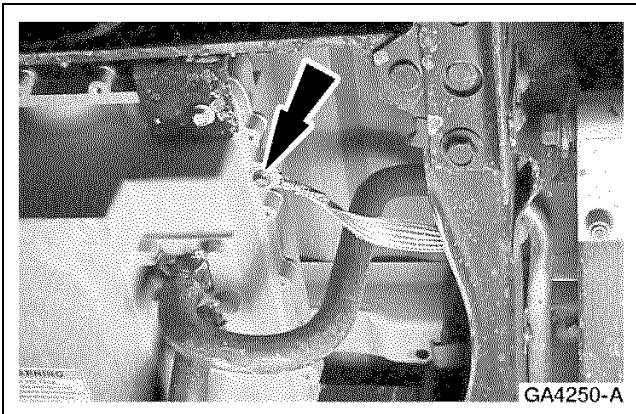

4. Remove the ground strap bolt.

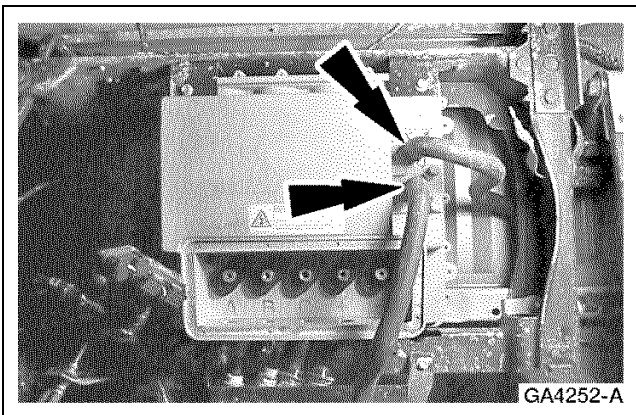

5. Clamp off and disconnect the coolant hoses.

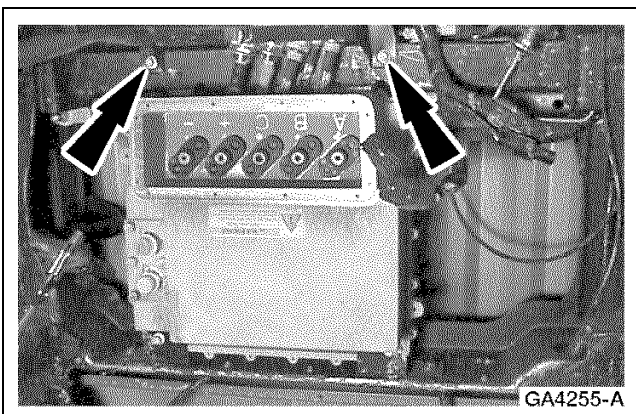

6. Remove the TIM mounting bolts.

## REMOVAL AND INSTALLATION (Continued)

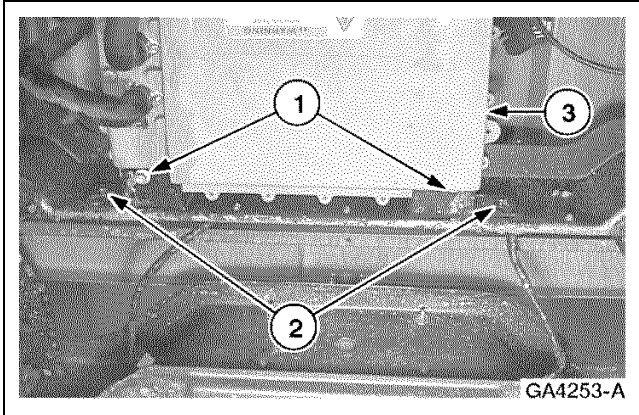

7. Remove the TIM.
  - 1 Loosen the TIM bracket bolts.
  - 2 Remove the bracket to frame bolts.
  - 3 Remove the TIM.

### Installation

1. To install, reverse the removal procedure.
  - 1 If excessive amounts of coolant were lost during the removal procedure, bleed the cooling system. Refer to [Section 303-03](#).

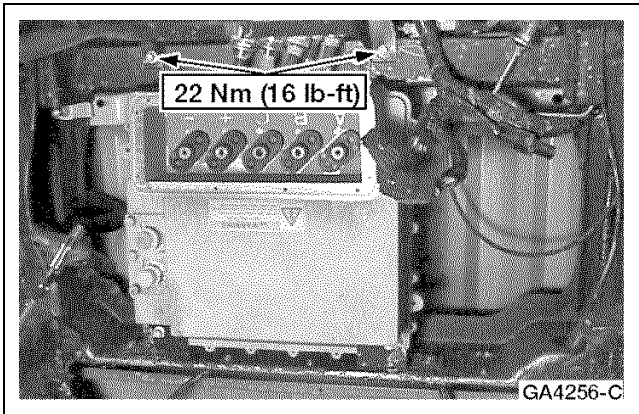
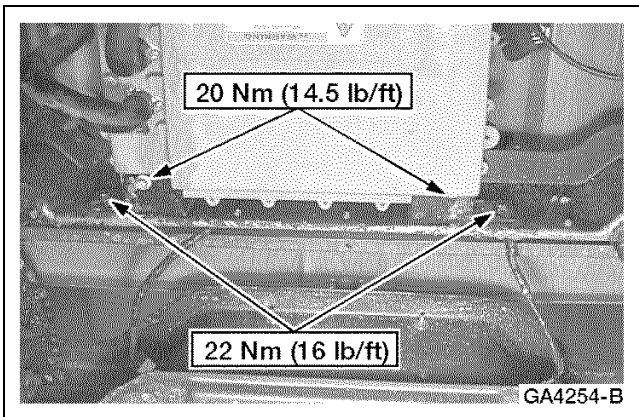

REMOVAL AND INSTALLATION (Continued)

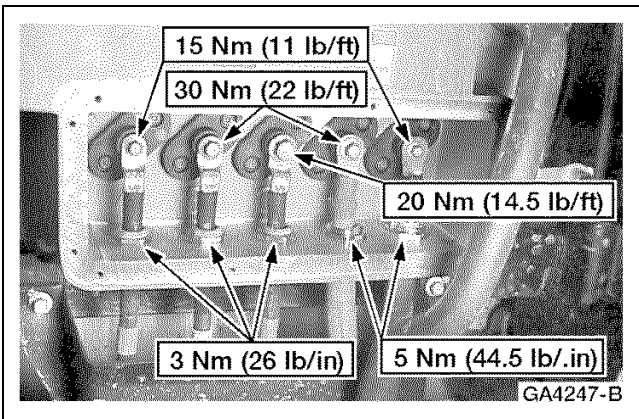
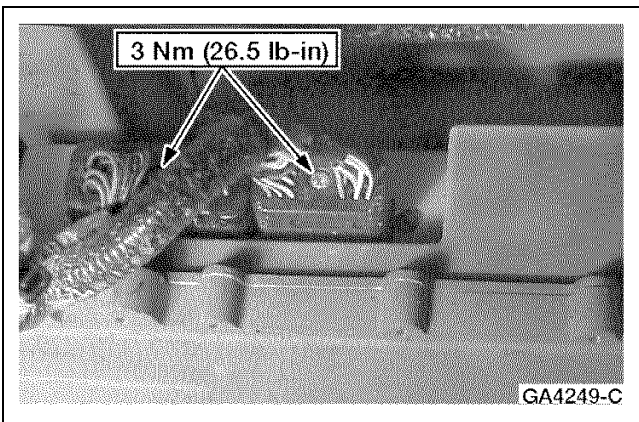
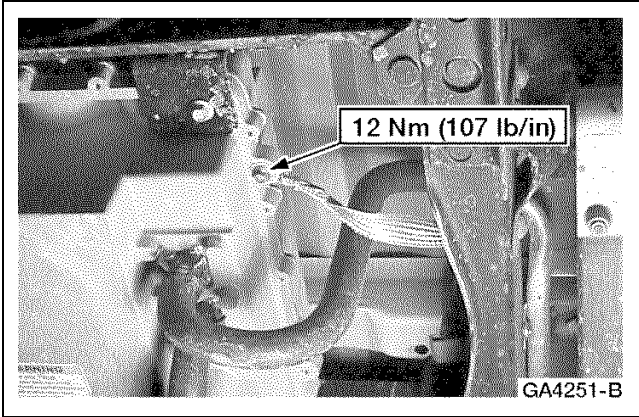

**REMOVAL AND INSTALLATION (Continued)**

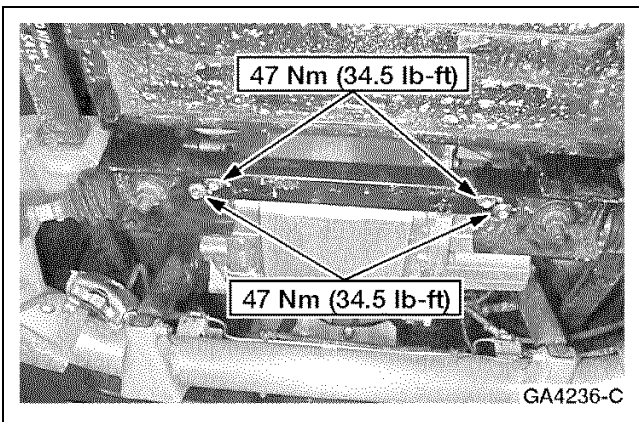
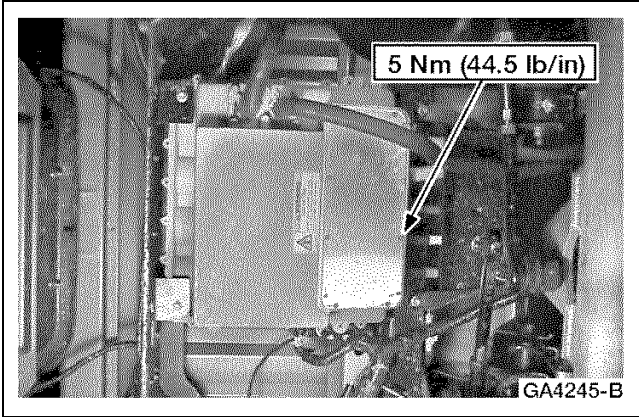

---

[Manual Table of Contents](#)

## SECTION 307-05 Automatic Transaxle External Controls

VEHICLE APPLICATION: Ranger EV

CONTENTS	PAGE
<b>SPECIFICATIONS</b> .....	307-05-2
<b>DESCRIPTION AND OPERATION</b>	
Automatic Transaxle External Controls .....	307-05-2
<b>DIAGNOSIS AND TESTING</b>	
Digital Transmission Range (DTR) Sensor .....	307-05-2
Electrical Schematic .....	307-05-2
Inspection and Verification .....	307-05-2
Pinpoint Tests .....	307-05-4
Symptom Chart .....	307-05-3
<b>GENERAL PROCEDURES</b>	
Digital Transmission Range (DTR) Sensor Alignment .....	307-05-11
PRNDE Shifter Adjustment .....	307-05-10
<b>REMOVAL AND INSTALLATION</b>	
Digital Transmission Range (DTR) Sensor .....	307-05-16
Motor/Transaxle Shift Cable .....	307-05-14

## SPECIFICATIONS

### Torque Specifications

Description	Nm	Lb-Ft	Lb-In
Bracket to Motor/Transaxle Bolts	64	47	—
Digital Transmission Range Sensor Bolts	10	—	89
Lug Nuts	115	85	—

(Continued)

### Torque Specifications

Description	Nm	Lb-Ft	Lb-In
Motor Mount Nuts	55	40.5	—
Motor Mount Through Bolt Nut	115	84.5	—
Shift Lever Nut	13	—	116

## DESCRIPTION AND OPERATION

### Automatic Transaxle External Controls

The motor/transaxle is switched into different modes by moving the shift lever into the desired position. A shift cable connects the shift lever to the motor/transaxle. A digital transmission range (DTR) sensor is mounted on the LH side of the motor/transaxle. The DTR sensor moves in direct relation to the shift lever. This sensor provides the traction inverter module (TIM) with gear selection information. The sensor is adjustable and must be realigned whenever the sensor is removed.

## DIAGNOSIS AND TESTING

### Digital Transmission Range (DTR) Sensor

#### Diagnostic Trouble Code (DTC) Definition

The following DTCs relate to the digital transmission range (DTR) sensor:

- DTC C1860 PRNDL Input #3 Circuit Failure
  - The digital transmission range (DTR) sensor provides an analog input (TR3A) along with three digital inputs to indicate to the traction inverter module (TIM) which gear has been selected. DTC C1860 is set if the voltage on the TR3A input is greater than 2.6 volts. If this failure occurs, the malfunction indicator lamp (MIL) illuminates, the power limit warning indicator flashes, and the TIM defaults the vehicle to NEUTRAL.

- DTC C1861 PRNDL Input #4 Circuit Failure
  - The digital transmission range (DTR) sensor provides an analog input (TR3A) along with three digital inputs to indicate to the traction inverter module (TIM) which gear has been selected. DTC C1861 is set if there is an invalid combination of the TR3A input and the three digital inputs from the DTR sensor. If this failure occurs, the malfunction indicator lamp (MIL) illuminates, the power limit warning indicator flashes, and the TIM defaults the vehicle to NEUTRAL.

#### Electrical Schematic

Refer to Electrical and Vacuum Troubleshooting Manual, Cell 26, Motor/Transaxle Control for schematic and connector information.

#### Inspection and Verification

Refer to [Section 100-07](#).

**DIAGNOSIS AND TESTING (Continued)****Symptom Chart****Symptom Chart**

<b>Condition</b>	<b>Possible Sources</b>	<b>Action</b>
<ul style="list-style-type: none"> <li>DTC C1860 PRNDL Input #3 Circuit Failure</li> </ul>	<ul style="list-style-type: none"> <li>Digital transmission range (DTR) sensor alignment.</li> <li>DTR sensor.</li> <li>Circuit(s).</li> <li>Traction inverter module (TIM).</li> <li>Battery control module (BCM).</li> </ul>	<ul style="list-style-type: none"> <li>GO to Pinpoint Test A.</li> </ul>
<ul style="list-style-type: none"> <li>DTC C1861 PRNDL Input #4 Circuit Failure</li> </ul>	<ul style="list-style-type: none"> <li>Digital transmission range (DTR) sensor alignment.</li> <li>DTR sensor.</li> <li>Circuit(s).</li> <li>Traction inverter module (TIM).</li> <li>Battery control module (BCM).</li> </ul>	<ul style="list-style-type: none"> <li>GO to Pinpoint Test A.</li> </ul>
<ul style="list-style-type: none"> <li>Vehicle Will Not Start in PARK or NEUTRAL</li> </ul>	<ul style="list-style-type: none"> <li>Shift cable alignment.</li> <li>Digital transmission range (DTR) sensor alignment.</li> <li>DTR sensor.</li> <li>Circuit(s).</li> <li>Traction inverter module (TIM).</li> <li>Battery control module (BCM).</li> </ul>	<ul style="list-style-type: none"> <li>CHECK shift cable alignment. REFER to PRNDE Shifter Adjustment in this section. If OK, GO to Pinpoint Test A.</li> </ul>
<ul style="list-style-type: none"> <li>Loss of Drive Operation — Vehicle Will Not Move in REVERSE or DRIVE</li> </ul>	<ul style="list-style-type: none"> <li>Shift cable alignment.</li> <li>Digital transmission range (DTR) sensor alignment.</li> <li>DTR sensor.</li> <li>Circuit(s).</li> <li>Traction inverter module (TIM).</li> <li>Battery control module (BCM).</li> </ul>	<ul style="list-style-type: none"> <li>CHECK shift cable alignment. REFER to PRNDE Shifter Adjustment in this section. If OK, GO to Pinpoint Test A.</li> </ul>
<ul style="list-style-type: none"> <li>Shift Lever Will Not Move to the PARK Position, Is Stuck in the PARK Position, or Will Not Stay in the PARK Position</li> </ul>	<ul style="list-style-type: none"> <li>Shift cable alignment.</li> <li>Digital transmission range (DTR) sensor alignment.</li> <li>Motor/transaxle.</li> </ul>	<ul style="list-style-type: none"> <li>CHECK shift cable alignment. REFER to PRNDE Shifter Adjustment in this section. If OK, VERIFY the shift lever on the transaxle can rotate. If the shift lever cannot rotate, REMOVE the DTR sensor and RETRY rotating the shift lever. If shift lever still cannot rotate, REPLACE the motor/transaxle. REFER to Section 303-01. If OK, GO to Pinpoint Test B.</li> </ul>



**DIAGNOSIS AND TESTING (Continued)**

**Symptom Chart (Continued)**

Condition	Possible Sources	Action
<ul style="list-style-type: none"> <li>Vehicle Does Not Remain Stationary With Transmission Range Selector Lever in the PARK Position</li> </ul>	<ul style="list-style-type: none"> <li>Halfshafts.</li> <li>Motor mounts.</li> <li>Shift cable alignment.</li> <li>Digital transmission range (DTR) sensor alignment.</li> <li>Motor/transaxle.</li> </ul>	<ul style="list-style-type: none"> <li>CHECK halfshafts and motor mounts. REPAIR as necessary. If OK, CHECK shift cable alignment. REFER to PRNDE Shifter Adjustment in this section. If OK, GO to Pinpoint Test B.</li> </ul>
<ul style="list-style-type: none"> <li>Shift Lever Will Not Move to the Selected Position, Is Stuck in the Selected Position, or Will Not Stay in the Selected Position</li> </ul>	<ul style="list-style-type: none"> <li>Shift cable alignment.</li> <li>Digital transmission range (DTR) sensor alignment.</li> <li>DTR sensor.</li> <li>Circuit(s).</li> <li>Traction inverter module (TIM).</li> <li>Battery control module (BCM).</li> </ul>	<ul style="list-style-type: none"> <li>CHECK shift cable alignment. REFER to PRNDE Shifter Adjustment in this section. If OK, VERIFY the shift lever on the transaxle can rotate. If the shift lever cannot rotate, REMOVE the DTR sensor and RETRY rotating the shift lever. If shift lever still cannot rotate, REPLACE the motor/transaxle. REFER to Section 303-01. If OK, GO to Pinpoint Test A.</li> </ul>

**Pinpoint Tests**

**Special Tool(s)**

104-Pin Breakout Box (BOB) 418-049 (014-00950) or equivalent
BCM/TIM Breakout Box (BOB) Adapter Cable 418-F212
BCM/TIM Breakout Box (BOB) Overlay 418-F220
Traction Battery High Voltage Service Cord 418-F218

(Continued)

**Special Tool(s)**

Traction Battery Low Voltage Service Cord 418-F219
High Voltage Insulated Gloves 100-F036 or equivalent
Face Shield 100-F035 or equivalent
Digital TR Sensor Alignment Tool 307-351 (T97L-70010-A)
Transmission Tester 007-00130 or equivalent
TR-E Cable 418-F107 (007-00111) or equivalent
Digital TR Sensor Overlay 007-00131 or equivalent

**PINPOINT TEST A: DIGITAL TRANSMISSION RANGE (DTR) SENSOR CIRCUIT FAILURE**

TEST STEP	ACTION TO TAKE
<p><b>A1 VERIFY DIGITAL TRANSMISSION RANGE (DTR) SENSOR ALIGNMENT</b></p> <ul style="list-style-type: none"> <li>With key OFF, set the gear selector to the PARK position.</li> </ul> <p><b>NOTE:</b> Check to make sure the DTR sensor harness connector C4996 is fully seated, terminals are fully engaged in connector and in good condition before proceeding.</p> <ul style="list-style-type: none"> <li>Apply the parking brake.</li> <li>Set the gear selector to NEUTRAL and verify the shift linkage is adjusted in the NEUTRAL position.</li> <li>With the gear selector in NEUTRAL, verify the Digital TR Sensor Alignment Tool fits in the appropriate slots.</li> <li><b>Is the DTR sensor correctly aligned?</b></li> </ul>	<p>Yes = REMOVE the alignment tool. GO to <b>A2</b>.</p> <p>No = REALIGN the DTR sensor. REFER to Digital Transmission Range (DTR) Sensor Alignment in this section.</p>
<p><b>A2 VISUALLY INSPECT DTR SENSOR CONNECTOR</b></p> <ul style="list-style-type: none"> <li>Set the gear selector to the PARK position.</li> </ul>	<p>Yes = REPAIR as necessary.</p>

(Continued)

**DIAGNOSIS AND TESTING (Continued)****PINPOINT TEST A: DIGITAL TRANSMISSION RANGE (DTR) SENSOR CIRCUIT FAILURE**

TEST STEP	ACTION TO TAKE
<ul style="list-style-type: none"> <li>•  <b>CAUTION: DO NOT PRY on connector. This will damage the connector and result in a motor/transaxle concern.</b> With key OFF, disconnect DTR sensor C4996 and inspect both ends of the connector for damage or pushed out pins, corrosion, loose wires, and missing or damaged seals.</li> <li>• <b>Is there damage to the connector, pins, or harness?</b></li> </ul>	No = GO to <b>A3</b> .
<b>A3 CHECK ELECTRICAL SYSTEM OPERATION FOR DTR SENSOR AND TRACTION INVERTER MODULE (TIM)</b> <ul style="list-style-type: none"> <li>• With key OFF, reconnect DTR sensor C4996.</li> <li>• Monitor the TIM PID TRANSGR.</li> <li>• Shift the transmission range selector lever into each gear and stop.</li> <li>• Observe the TRANSGR PID while wiggling harness and tapping on sensor.</li> <li>• <b>Does the TRANSGR PID match the selected gear and does the TRANSGR PID remain steady when the harness is wiggled or when the sensor is tapped?</b></li> </ul>	Yes = System OK. No = If TRANSGR PID changes when wiggling the harness or tapping on the sensor, the concern may be intermittent. GO to <b>A4</b> .
<b>A4 CHECK DTR SENSOR OPERATION</b> <ul style="list-style-type: none"> <li>• With key OFF, disconnect DTR sensor C4996.</li> <li>• Connect TR-E Cable to Transmission Tester and DTR sensor.</li> <li>• Place the Digital TR Sensor Overlay onto Transmission Tester.</li> </ul> <p><b>NOTE:</b> The D/2 status lamp on TR-E Cable should illuminate when the transmission range selector lever is moved to the ECONOMY position.</p> <ul style="list-style-type: none"> <li>• Carry out Sensor Test as instructed on Digital TR Sensor Overlay.</li> <li>• <b>Does the status lamp on TR-E Cable match the selected gear positions?</b></li> </ul>	Yes = The concern is not in the DTR sensor. REMOVE Transmission Tester and TR-E Cable. GO to <b>A5</b> . No = REPLACE the DTR sensor and ALIGN; REFER to Digital Transmission Range (DTR) Sensor Alignment in this section.
<b>A5 CHECK TR1 INPUT SIGNAL STATUS</b> <ul style="list-style-type: none"> <li>• With key OFF, reconnect DTR sensor C4996.</li> <li>• With key ON, monitor TIM PID PRNDE__1.</li> <li>• With brake pedal depressed, shift the transmission range selector lever through all gears and back to PARK.</li> <li>• Compare PRNDE__1 PID to the values below:             PARK = ACTIVE            REVERSE = ACTIVE            NEUTRAL = ACTIVE            DRIVE = notACT            ECONOMY = notACT</li> <li>• <b>Is the PRNDE__1 PID correct?</b></li> </ul>	Yes = GO to <b>A9</b> . No = If all gears indicate notACT, GO to <b>A6</b> .  If all gears indicate ACTIVE, GO to <b>A8</b> .
<b>A6 CHECK CIRCUIT 3500 (R) FOR OPEN</b> <ul style="list-style-type: none"> <li>• Connect 104-Pin Breakout Box (BOB) to TIM C4998, C4999 using the BCM/TIM BOB Adapter Cable and Overlay; leave the TIM disconnected.</li> <li>• With key OFF, disconnect DTR sensor C4996 and measure the resistance of the R wire between pin 4 on the DTR sensor C4996 and BOB pin B7.</li> <li>• <b>Is the resistance less than 5 ohms?</b></li> </ul>	Yes = GO to <b>A7</b> . No = REPAIR the R wire.
<b>A7 CHECK CIRCUIT 3500 (R) FOR SHORT TO POWER</b>	



(Continued)

**DIAGNOSIS AND TESTING (Continued)****PINPOINT TEST A: DIGITAL TRANSMISSION RANGE (DTR) SENSOR CIRCUIT FAILURE**

TEST STEP	ACTION TO TAKE
<ul style="list-style-type: none"> <li>With key ON, measure the voltage between BOB pin B7 and ground (BOB pin A29).</li> <li><b>Is the voltage greater than 0 volts?</b></li> </ul>	Yes = REPAIR the R wire. REPLACE the DTR sensor. No = REPLACE the TIM. REFER to Section 303-14.
<b>A8 CHECK CIRCUIT 3500 (R) FOR SHORT TO GROUND</b> <ul style="list-style-type: none"> <li>Connect 104-Pin Breakout Box (BOB) to TIM C4998, C4999 using the BCM/TIM BOB Adapter Cable and Overlay; leave the TIM disconnected.</li> <li>With key OFF, disconnect DTR sensor C4996 and measure the resistance between BOB pin B7 and ground (BOB pin A29).</li> <li><b>Is the resistance greater than 10,000 ohms?</b></li> </ul>	Yes = REPLACE the TIM. REFER to Section 303-14. No = REPAIR the R wire.
<b>A9 CHECK TR2 INPUT SIGNAL STATUS</b> <ul style="list-style-type: none"> <li>With key ON, monitor TIM PID PRNDE__2.</li> <li>With brake pedal depressed, shift the transmission range selector lever through all gears and back to PARK.</li> <li>Compare PRNDE__2 PID to the values below:</li> <li></li> </ul> <p>PARK = ACTIVE            REVERSE = ACTIVE            NEUTRAL = notACT            DRIVE = notACT            ECONOMY = ACTIVE</p> <ul style="list-style-type: none"> <li><b>Is the PRNDE__2 PID correct?</b></li> </ul>	Yes = GO to <b>A16</b> . No = If all gears indicate notACT, GO to <b>A10</b> .  If all gears indicate ACTIVE, GO to <b>A13</b> .
<b>A10 CHECK CIRCUIT 3501 (DB) FOR OPEN</b> <ul style="list-style-type: none"> <li>Connect 104-Pin Breakout Box (BOB) to TIM C4998, C4999 using the BCM/TIM BOB Adapter Cable and Overlay; leave the TIM disconnected.</li> <li>With key OFF, disconnect DTR sensor C4996 and measure the resistance of the DB wire between pin 5 on the DTR sensor C4996 and BOB pin B20.</li> <li><b>Is the resistance less than 5 ohms?</b></li> </ul>	Yes = GO to <b>A11</b> . No = REPAIR the DB wire.
<b>A11 CHECK CIRCUIT 3501 (DB) (OUTSIDE OF TRACTION BATTERY SUPPORT TRAY) FOR SHORT TO POWER</b> <ul style="list-style-type: none"> <li>With key OFF, disconnect traction battery support tray in-line C1939.</li> <li>With key ON, measure the voltage between BOB pin B20 and ground (BOB pin A29).</li> <li><b>Is the voltage greater than 0 volts?</b></li> </ul>	Yes = REPAIR the DB wire. REPLACE the DTR sensor. No = GO to <b>A12</b> .
<b>A12 CHECK CIRCUIT 3501 (DB) (INSIDE OF TRACTION BATTERY SUPPORT TRAY) FOR SHORT TO POWER</b> <ul style="list-style-type: none"> <li>Remove the traction battery and connect Traction Battery High-Voltage Lockout and Diagnostic Tool to the traction battery high-voltage 2-pin C3994M.</li> <li>Connect Traction Battery Low Voltage Service Cord to traction battery support tray in-line C1939F and in-line C1939M.</li> <li>Connect Traction Battery High Voltage Service Cord to traction battery support tray in-line C1935F and in-line C1935M.</li> </ul>	Yes = REPAIR the DB wire. REPLACE the DTR sensor. No = REPLACE the TIM. REFER to Section 303-14.

(Continued)

**DIAGNOSIS AND TESTING (Continued)****PINPOINT TEST A: DIGITAL TRANSMISSION RANGE (DTR) SENSOR CIRCUIT FAILURE**

TEST STEP	ACTION TO TAKE
<p> <b>WARNING: The traction battery contains high-voltage components and wiring. High-voltage insulated safety gloves and face shield must be worn when carrying out the following steps. Failure to follow this warning may result in severe personal injury or death.</b></p> <ul style="list-style-type: none"> <li>• With key OFF, disconnect BCM C1987.</li> <li>• With key ON, measure the voltage between BOB pin B20 and ground (BOB pin A29).</li> <li>• <b>Is the voltage greater than 0 volts?</b></li> </ul>	
<p><b>A13 CHECK CIRCUIT 3501 (DB) (OUTSIDE OF TRACTION BATTERY SUPPORT TRAY) FOR SHORT TO GROUND</b></p> <ul style="list-style-type: none"> <li>• With key OFF, disconnect DTR sensor C4996 and traction battery support tray in-line C1939.</li> <li>• With key OFF, measure the resistance between BOB pin B20 and ground (BOB pin A29).</li> <li>• <b>Is the resistance greater than 10,000 ohms?</b></li> </ul>	<p>Yes = GO to <b>A14</b>.</p> <p>No = REPAIR the DB wire.</p>
<p><b>A14 CHECK TR2 SIGNAL LINE TO BATTERY CONTROL MODULE (BCM) (INSIDE OF TRACTION BATTERY SUPPORT TRAY) FOR SHORT TO GROUND</b></p> <ul style="list-style-type: none"> <li>• With key OFF, remove BOB from TIM C4998 and C4999.</li> <li>• Connect BOB to traction battery support tray in-line C1939F using Traction Battery Low Voltage Service Cord; do not connect Traction Battery Low Voltage Service Cord to in-line C1939M.</li> <li>• With key OFF, measure the resistance between BOB pin 40 and ground (BOB pin 65).</li> <li>• <b>Is the resistance greater than 10,000 ohms?</b></li> </ul>	<p>Yes = REPLACE the TIM. REFER to Section 303-14.</p> <p>No = GO to <b>A15</b>.</p>
<p><b>A15 CHECK CIRCUIT 3501 (DB) (INSIDE OF TRACTION BATTERY SUPPORT TRAY) FOR SHORT TO GROUND</b></p> <ul style="list-style-type: none"> <li>• Remove the traction battery and connect Traction Battery High-Voltage Lockout and Diagnostic Tool to the traction battery high-voltage 2-pin C3994M.</li> </ul> <p> <b>WARNING: The traction battery contains high-voltage components and wiring. High-voltage insulated safety gloves and face shield must be worn when carrying out the following steps. Failure to follow this warning may result in severe personal injury or death.</b></p> <ul style="list-style-type: none"> <li>• Connect BOB to traction battery support tray in-line C1939F using Traction Battery Low Voltage Service Cord; do not connect Traction Battery Low Voltage Service Cord to in-line C1939M.</li> <li>• With key OFF, disconnect BCM C1987 and measure the resistance between BOB pin 40 and ground (BOB pin 65).</li> <li>• <b>Is the resistance greater than 10,000 ohms?</b></li> </ul>	<p>Yes = REPLACE the BCM. REFER to Section 414-03.</p> <p>No = REPAIR the DB wire.</p>
<p><b>A16 CHECK TR3A INPUT SIGNAL STATUS</b></p> <ul style="list-style-type: none"> <li>• With key ON, monitor TIM PID PRNDE__3.</li> <li>• With brake pedal depressed, shift the transmission range selector lever through all gears and back to PARK.</li> <li>• Compare PRNDE__3 PID to the values below:  PARK = ACTIVE  REVERSE = notACT  NEUTRAL = notACT  DRIVE = notACT  ECONOMY = ACTIVE</li> <li>• <b>Is the PRNDE__3 PID correct?</b></li> </ul>	<p>Yes = GO to <b>A20</b>.</p> <p>No = GO to <b>A17</b>.</p>

(Continued)

**DIAGNOSIS AND TESTING (Continued)****PINPOINT TEST A: DIGITAL TRANSMISSION RANGE (DTR) SENSOR CIRCUIT FAILURE**

TEST STEP	ACTION TO TAKE
<b>A17 CHECK CIRCUITS 3502 (DG) AND 3504 (BK/O) FOR OPEN(S)</b> <ul style="list-style-type: none"> <li>• Connect 104-Pin Breakout Box (BOB) to TIM C4998, C4999 using the BCM/TIM BOB Adapter Cable and Overlay; leave the TIM disconnected.</li> <li>• With key OFF, disconnect DTR sensor C4996 and measure the resistance of the DG wire between pin 3 on the DTR sensor C4996 and BOB pin B18.</li> <li>• With key OFF, measure the resistance of the BK/O wire between pin 2 on the DTR sensor C4996 and BOB pin B24.</li> <li>• <b>Are the resistances less than 5 ohms?</b></li> </ul>	Yes = GO to <b>A18</b> .  No = REPAIR the wire(s) in question.
<b>A18 CHECK CIRCUIT 3502 (DG) FOR SHORT TO GROUND</b> <ul style="list-style-type: none"> <li>• With key OFF, measure the resistance between BOB pin B18 and ground (BOB pin A29).</li> <li>• <b>Is the resistance greater than 10,000 ohms?</b></li> </ul>	Yes = GO to <b>A19</b> .  No = REPAIR the DG wire.
<b>A19 CHECK CIRCUIT 3502 (DG) FOR SHORT TO POWER</b> <ul style="list-style-type: none"> <li>• With key ON, measure the voltage between BOB pin B18 and ground (BOB pin A29).</li> <li>• <b>Is the voltage greater than 0 volts?</b></li> </ul>	Yes = REPAIR the DG wire. REPLACE the DTR sensor.  No = REPLACE the TIM. REFER to Section 303-14.
<b>A20 CHECK TR4 INPUT SIGNAL STATUS</b> <ul style="list-style-type: none"> <li>• With key ON, monitor TIM PID PRNDE__4.</li> <li>• With brake pedal depressed, shift the transmission range selector lever through all gears and back to PARK.</li> <li>• Compare PRNDE__4 PID to the values below:             PARK = ACTIVE            REVERSE = notACT            NEUTRAL = ACTIVE            DRIVE = notACT            ECONOMY = notACT</li> <li>• <b>Is the PRNDE__4 PID correct?</b></li> </ul>	Yes = System OK. CHECK wiring for intermittent connections.  No = If all gears indicate notACT, GO to <b>A21</b> . If all gears indicate ACTIVE, GO to <b>A24</b> .
<b>A21 CHECK CIRCUIT 3503 (Y) FOR OPEN</b> <ul style="list-style-type: none"> <li>• Connect 104-Pin Breakout Box (BOB) to TIM C4998, C4999 using the BCM/TIM BOB Adapter Cable and Overlay; leave the TIM disconnected.</li> <li>• With key OFF, disconnect DTR sensor C4996 and measure the resistance of the Y wire between pin 6 on the digital DTR sensor C4996 and BOB pin B13.</li> <li>• <b>Is the resistance less than 5 ohms?</b></li> </ul>	Yes = GO to <b>A22</b> .  No = REPAIR the Y wire.
<b>A22 CHECK CIRCUIT 3503 (Y) (OUTSIDE OF TRACTION BATTERY SUPPORT TRAY) FOR SHORT TO POWER</b> <ul style="list-style-type: none"> <li>• With key OFF, disconnect traction battery support tray in-line C1939.</li> <li>• With key ON, measure the voltage between BOB pin B13 and ground (BOB pin A29).</li> <li>• <b>Is the voltage greater than 0 volts?</b></li> </ul>	Yes = REPAIR the Y wire. REPLACE the DTR sensor.  No = GO to <b>A23</b> .
<b>A23 CHECK CIRCUIT 3503 (Y) (INSIDE OF TRACTION BATTERY SUPPORT TRAY) FOR SHORT TO POWER</b>	

(Continued)

**DIAGNOSIS AND TESTING (Continued)****PINPOINT TEST A: DIGITAL TRANSMISSION RANGE (DTR) SENSOR CIRCUIT FAILURE**

TEST STEP	ACTION TO TAKE
<ul style="list-style-type: none"> <li>• Remove the traction battery and connect Traction Battery High-Voltage Lockout and Diagnostic Tool to the traction battery high-voltage 2-pin C3994M.</li> <li>• Connect Traction Battery Low Voltage Service Cord to traction battery support tray in-line C1939F and in-line C1939M.</li> <li>• Connect Traction Battery High Voltage Service Cord to traction battery support tray in-line C1935F and in-line C1935M.</li> </ul> <p><b>⚠ WARNING: The traction battery contains high-voltage components and wiring. High-voltage insulated safety gloves and face shield must be worn when carrying out the following steps. Failure to follow this warning may result in severe personal injury or death.</b></p> <ul style="list-style-type: none"> <li>• With key OFF, disconnect BCM C1987.</li> <li>• With key ON, measure the voltage between BOB pin B13 and ground (BOB pin A29).</li> <li>• <b>Is the voltage greater than 0 volts?</b></li> </ul>	<p>Yes = REPAIR the Y wire. REPLACE the DTR sensor.</p> <p>No = REPLACE the TIM. REFER to Section 303-14.</p>
<p><b>A24 CHECK CIRCUIT 3503 (Y) (OUTSIDE OF TRACTION BATTERY SUPPORT TRAY) FOR SHORT TO GROUND</b></p> <ul style="list-style-type: none"> <li>• With key OFF, disconnect DTR sensor C4996 and traction battery support tray in-line C1939.</li> <li>• With key OFF, measure the resistance between BOB pin B13 and ground (BOB pin A29).</li> <li>• <b>Is the resistance greater than 10,000 ohms?</b></li> </ul>	<p>Yes = GO to <b>A25</b>.</p> <p>No = REPAIR the Y wire.</p>
<p><b>A25 CHECK TR4 SIGNAL LINE TO BATTERY CONTROL MODULE (BCM) (INSIDE OF TRACTION BATTERY SUPPORT TRAY) FOR SHORT TO GROUND</b></p> <ul style="list-style-type: none"> <li>• With key OFF, remove BOB from TIM C4998 and C4999.</li> <li>• Connect BOB to traction battery support tray in-line C1939F using Traction Battery Low Voltage Service Cord; do not connect Traction Battery Low Voltage Service Cord to in-line C1939M.</li> <li>• With key OFF, measure the resistance between BOB pin 52 and ground (BOB pin 65).</li> <li>• <b>Is the resistance greater than 10,000 ohms?</b></li> </ul>	<p>Yes = REPLACE the TIM. REFER to Section 303-14.</p> <p>No = GO to <b>A26</b>.</p>
<p><b>A26 CHECK CIRCUIT 3503 (Y) (INSIDE OF TRACTION BATTERY SUPPORT TRAY) FOR SHORT TO GROUND</b></p> <ul style="list-style-type: none"> <li>• Remove the traction battery and connect Traction Battery High-Voltage Lockout and Diagnostic Tool to the traction battery high-voltage 2-pin C3994M.</li> </ul> <p><b>⚠ WARNING: The traction battery contains high-voltage components and wiring. High-voltage insulated safety gloves and face shield must be worn when carrying out the following steps. Failure to follow this warning may result in severe personal injury or death.</b></p> <ul style="list-style-type: none"> <li>• Connect BOB to traction battery support tray in-line C1939F using Traction Battery Low Voltage Service Cord; do not connect Traction Battery Low Voltage Service Cord to in-line C1939M.</li> <li>• With key OFF, disconnect BCM C1987 and measure the resistance between BOB pin 52 and ground (BOB pin 65).</li> <li>• <b>Is the resistance greater than 10,000 ohms?</b></li> </ul>	<p>Yes = REPLACE the BCM. REFER to Section 414-03.</p> <p>No = REPAIR the Y wire.</p>

**DIAGNOSIS AND TESTING (Continued)**

**PINPOINT TEST B: DIGITAL TRANSMISSION RANGE (DTR) SENSOR ALIGNMENT VERIFICATION**

TEST STEP	ACTION TO TAKE
<p><b>B1 VERIFY DIGITAL TRANSMISSION RANGE (DTR) SENSOR ALIGNMENT</b></p> <ul style="list-style-type: none"> <li>• With key OFF, set the gear selector to the PARK position.</li> </ul> <p><b>NOTE:</b> Check to make sure the DTR sensor harness connector C4996 is fully seated and the terminals are fully engaged in the connector and in good condition before proceeding.</p> <ul style="list-style-type: none"> <li>• Apply the parking brake.</li> <li>• Set the gear selector to NEUTRAL and verify the shift linkage is adjusted in the NEUTRAL position.</li> <li>• With the gear selector in NEUTRAL, verify Digital TR Sensor Alignment Tool fits in the appropriate slots.</li> <li>• <b>Is the DTR sensor correctly adjusted?</b></li> </ul>	<p>Yes = REPLACE the motor/transaxle. REFER to Section 303-01.</p> <p>No = ADJUST the DTR sensor. REFER to Digital Transmission Range (DTR) Sensor Adjustment in this section.</p>

**GENERAL PROCEDURES**

**PRNDE Shifter Adjustment**

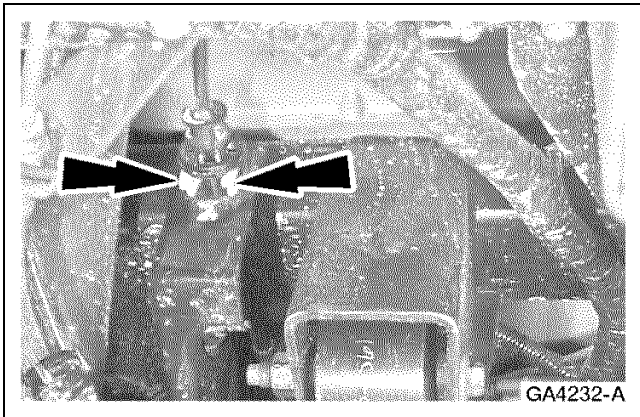

1. **NOTE:** The shift cable clip is located on the rear of the motor/transaxle to the left of the motor/transaxle rear mount.

Release the cable clip (push up).

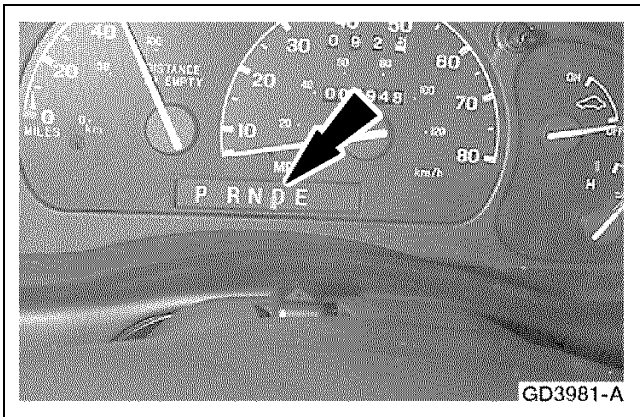

2. **NOTE:** A three-pound weight is required to hold the shifter in place while the rest of the procedure is performed.

Place the shifter in D (Drive) and place the indicator in the center of the D (Drive) position.

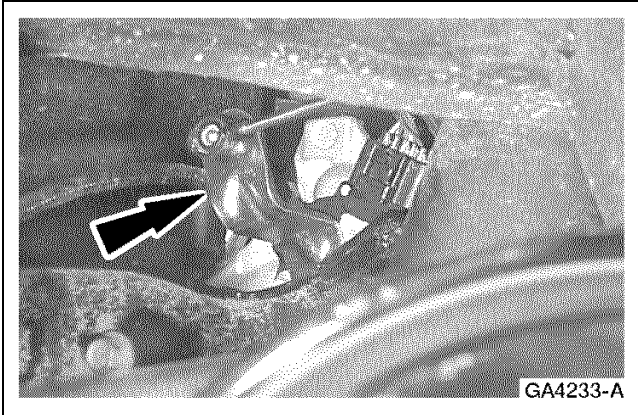
**GENERAL PROCEDURES (Continued)**

3. **NOTE:** The D (Drive) position is one position from the shift lever's most rearward position. Position the motor/transaxle shift lever in D (Drive).

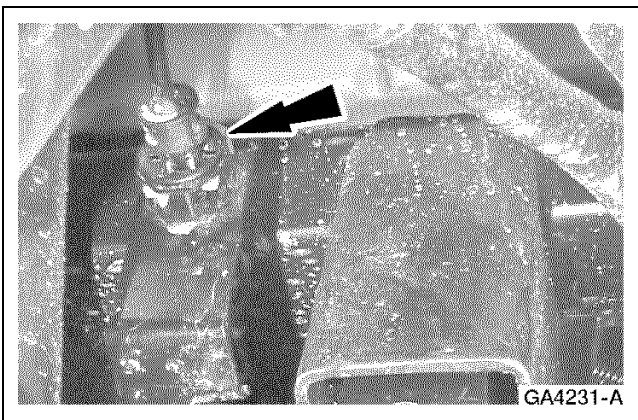

4. Engage the cable clip (push down).
5. Verify that the shifter has remained in the D (Drive) position and check for correct gearshift operation.

**Digital Transmission Range (DTR) Sensor Alignment****Special Tool(s)**

<p style="text-align: center;">ST2086-A</p>	<p>Digital Transmission Range (TR) Sensor Alignment Tool T97L-70010-A</p>
---	---

1. Place the gear selector in the N (Neutral) position.
2. Raise and support the vehicle. Refer to [Section 100-02](#).

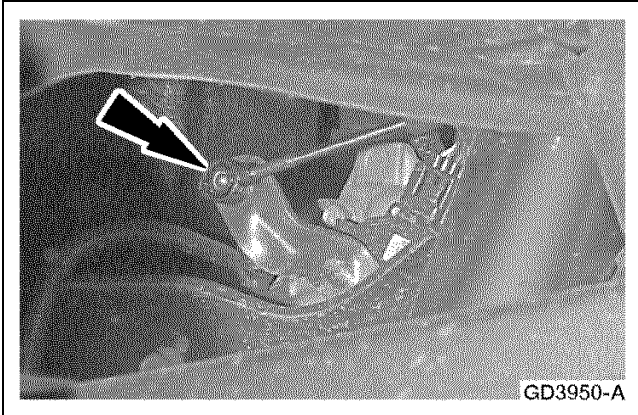

**GENERAL PROCEDURES (Continued)**

3. Disconnect the shift cable from the shift lever.

**NOTE:** The motor/transaxle is shown removed from the vehicle.

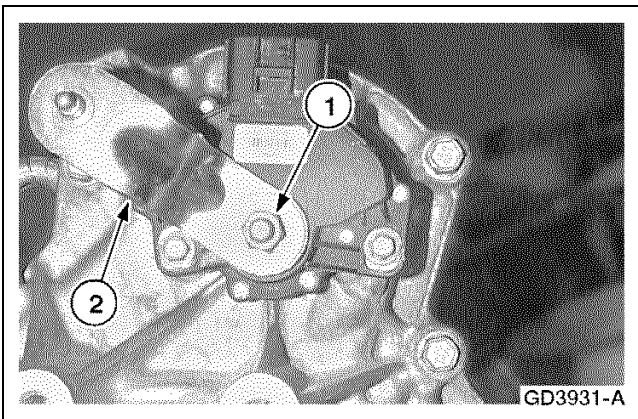

4. Remove the shift lever.
  - 1 Remove the nut.
  - 2 Remove the shift lever.

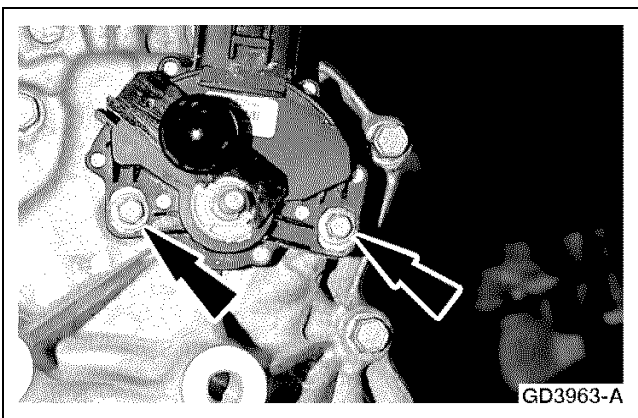

5. Loosen the sensor bolts.

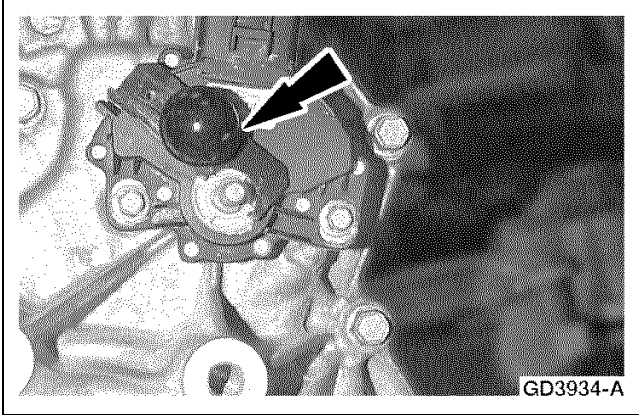
**GENERAL PROCEDURES (Continued)**

6. **NOTE:** Do not remove the alignment tool until the sensor bolts have been tightened.

Install the digital TR sensor alignment tool to positively locate the sensor in relation to the motor/transaxle neutral position.

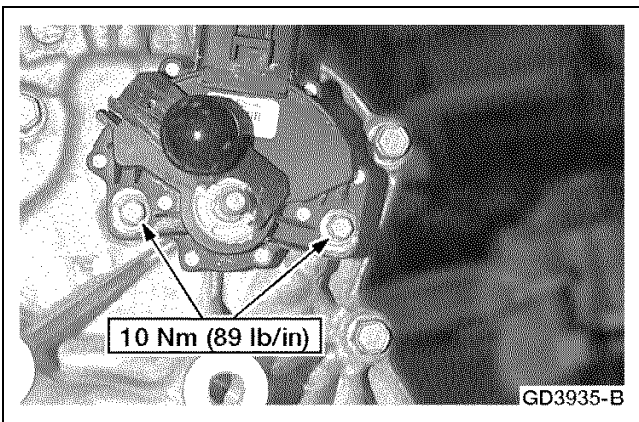

7. Tighten the sensor bolts.

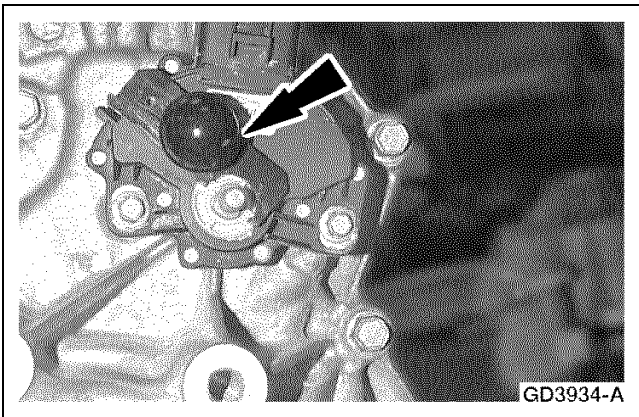

8. Remove the digital TR sensor alignment tool.

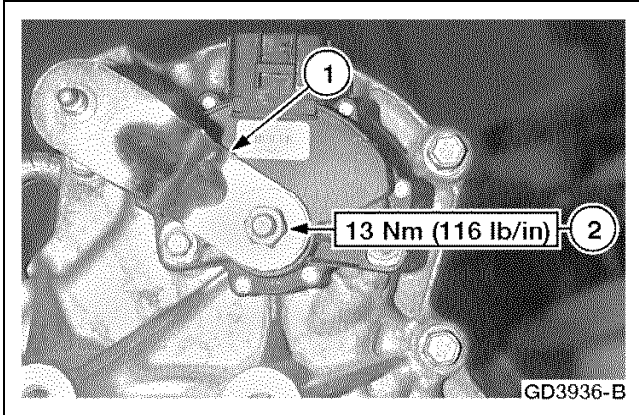
**GENERAL PROCEDURES (Continued)**

9. Install the shift lever.
  - 1 Install the shift lever.
  - 2 Install the nut.

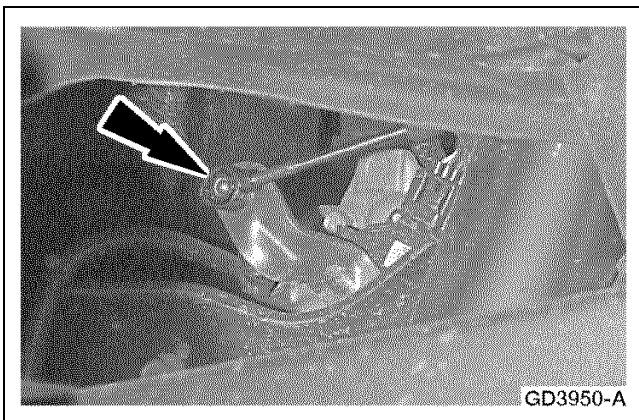

10. Connect the shift cable to the shift lever.

11. Adjust the shift cable. Refer to [PRNDE Shifter Adjustment](#).

**REMOVAL AND INSTALLATION****Motor/Transaxle Shift Cable****Removal**

1. Remove the traction battery. Refer to [Section 414-03A](#) or [Section 414-03B](#).

## REMOVAL AND INSTALLATION (Continued)

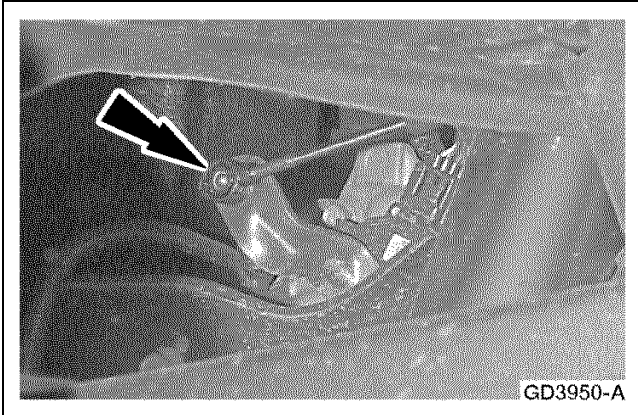

2. Disconnect the shift cable from the digital transmission range (DTR) sensor shift lever.

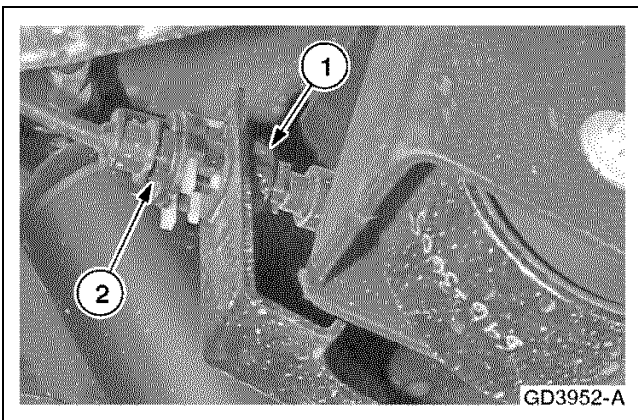

3. Disconnect the shift cable from the bracket.
  - 1 Depress the tabs.
  - 2 Slide the cable through the bracket.

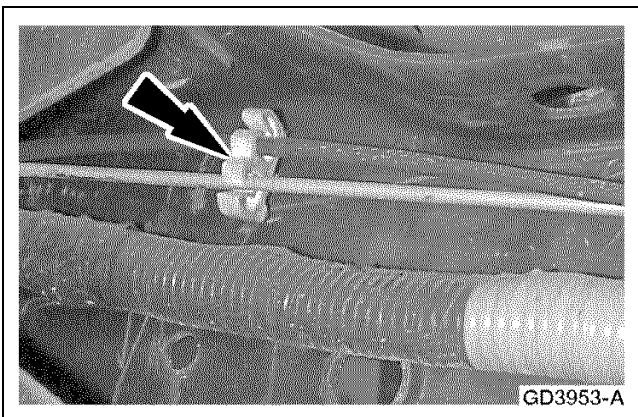

4. Unclip the shift cable from the four clips located inside the driver side frame rail.

5. **NOTE:** The shift cable connection is located under the driver side dash on the steering column. The shift cable connects to the steering column and the motor/transaxle in the same way.

Disconnect the shift cable from the steering column.

## REMOVAL AND INSTALLATION (Continued)

6. Disconnect the shift cable from the bracket.
  - Depress the tabs.
  - Slide the cable through the bracket.

7. Remove the cable.

### Installation

1. To install, reverse the removal procedure.
  - After installation, adjust the shift cable. Refer to [PRNDE Shifter Adjustment](#).

## Digital Transmission Range (DTR) Sensor

### Special Tool(s)

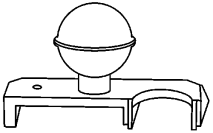
 <p style="text-align: center;">ST2086-A</p>	<p>Digital Transmission Range (TR) Sensor Alignment Tool T97L-70010-A</p>
--	---

### Removal

1. Place the gear selector in the N (Neutral) position.
2. Raise and support the vehicle. Refer to [Section 100-02](#).
3. Support the motor/transaxle using a high lift jack.

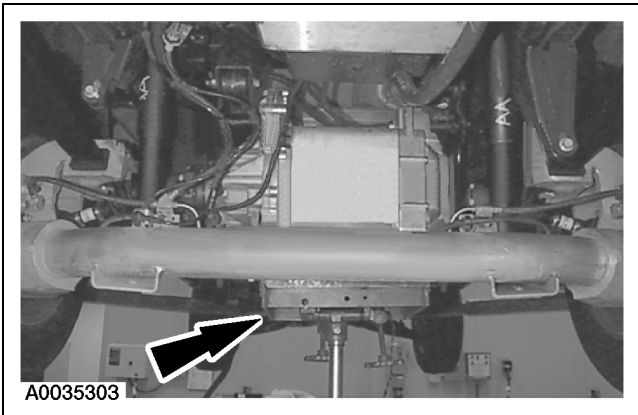

4. Remove the LH rear wheel.

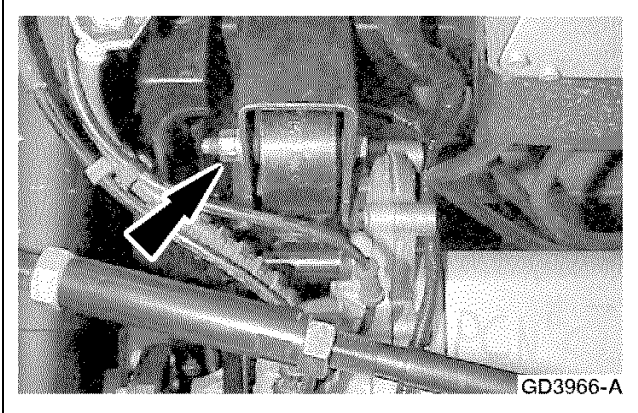
**REMOVAL AND INSTALLATION (Continued)**

5. Remove the motor mount through bolt.

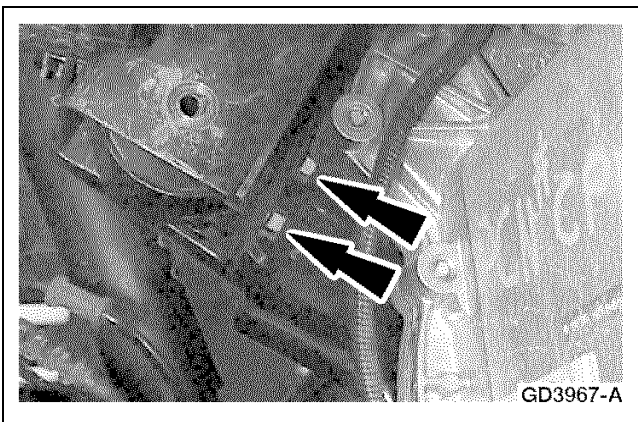

6. Remove the two motor mount nuts.

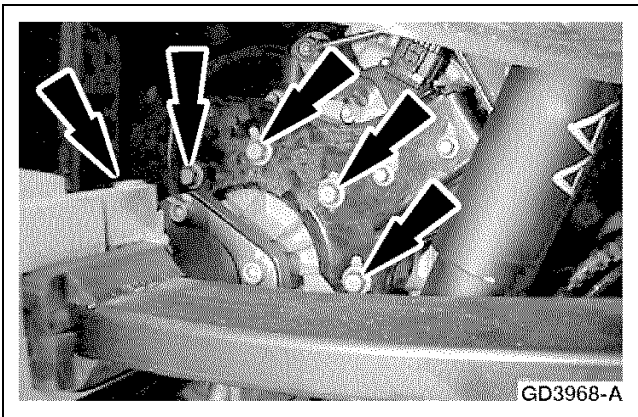

7. Remove the five motor mount bracket to motor/transaxle bolts.

## REMOVAL AND INSTALLATION (Continued)

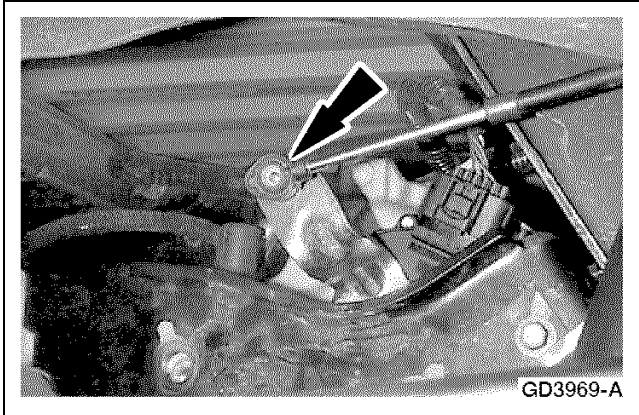

8. Disconnect the shift cable from the shift lever.

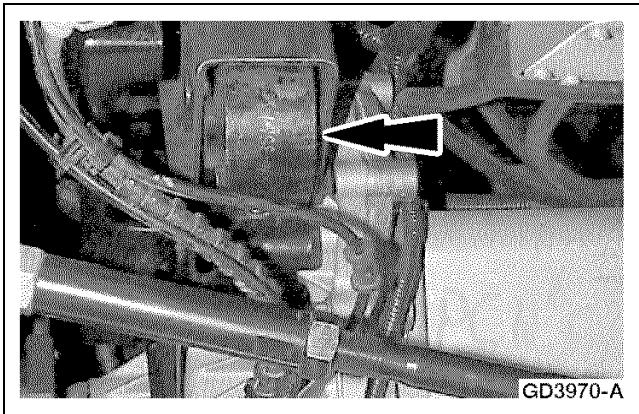

9. Lower the motor/transaxle approximately 2.5 cm (1 in).

10. Remove the motor/transaxle mount.

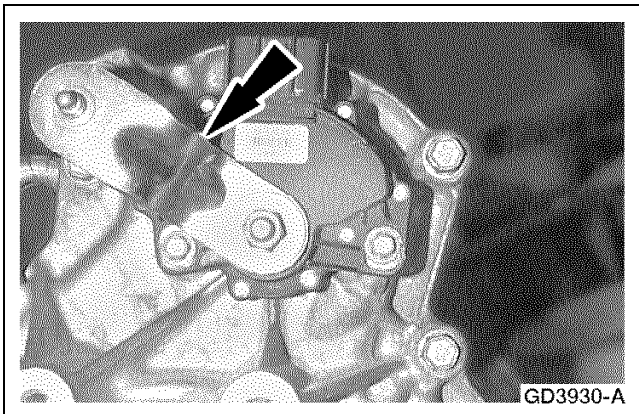

11. **NOTE:** The motor/transaxle is shown removed from the vehicle for clarity.

**NOTE:** The motor/transaxle must be in the N (Neutral) position prior to installation of the DTR sensor.

Position the motor/transaxle in N (Neutral).

- The N (Neutral) position is two positions from the shift lever's most forward position.

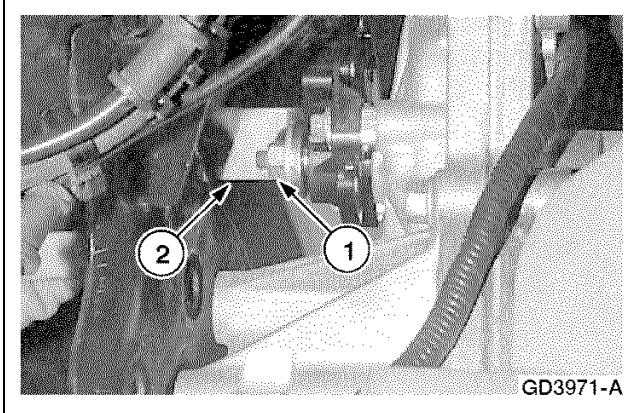
**REMOVAL AND INSTALLATION (Continued)**

12. Remove the digital transmission range (DTR) sensor lever.
  - 1 Remove the nut.
  - 2 Remove the lever.

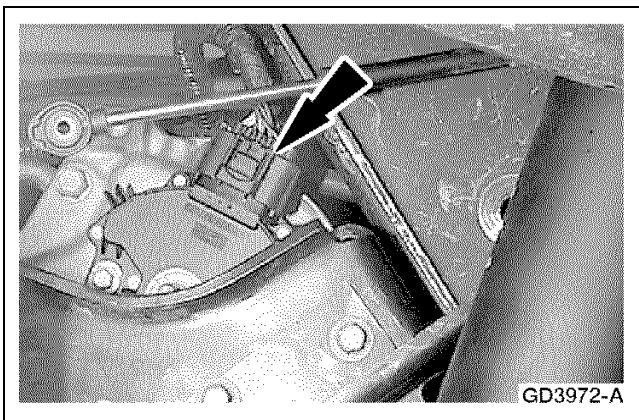

13. Disconnect the DTR sensor electrical connector.

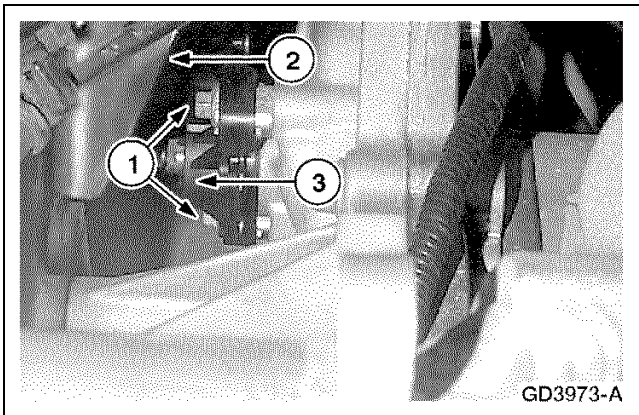

14. Remove the DTR sensor.
  - 1 Remove the two bolts.
  - 2 Pry the bracket away from the motor/transaxle.
  - 3 Remove the DTR sensor.

**Installation**

1. Verify that the gear selector is in the N (Neutral) position.

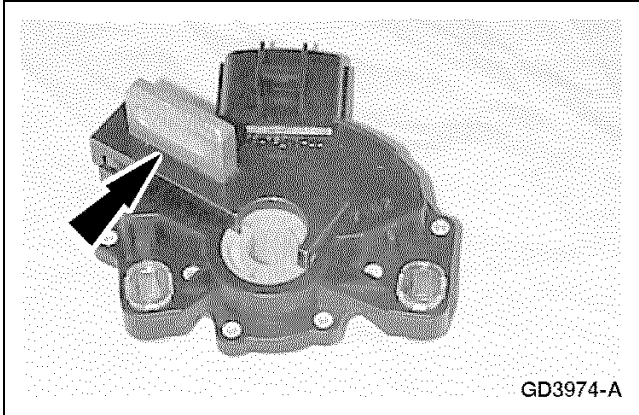

**REMOVAL AND INSTALLATION (Continued)**

2. Install the digital TR sensor alignment tool on the sensor.

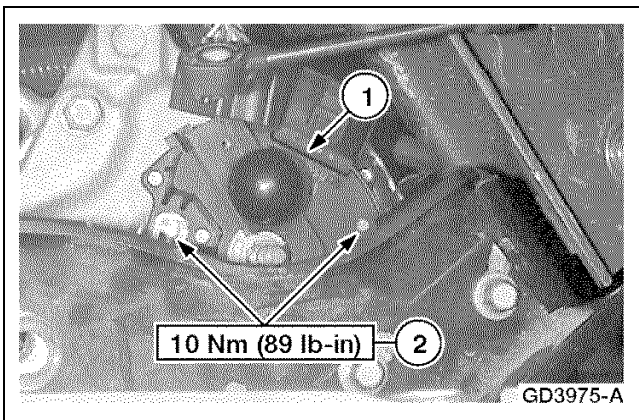

3. **NOTE:** The sensor is installed with alignment tool in place.  
Install the DTR sensor.
  - 1 Position the sensor on the motor/transaxle.
  - 2 Install the bolts.

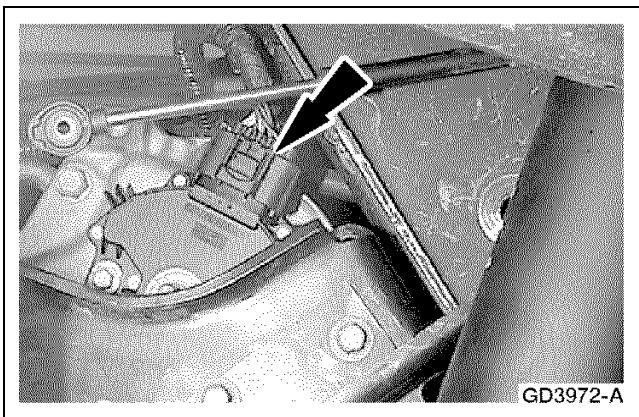

4. Connect the DTR sensor electrical connector.

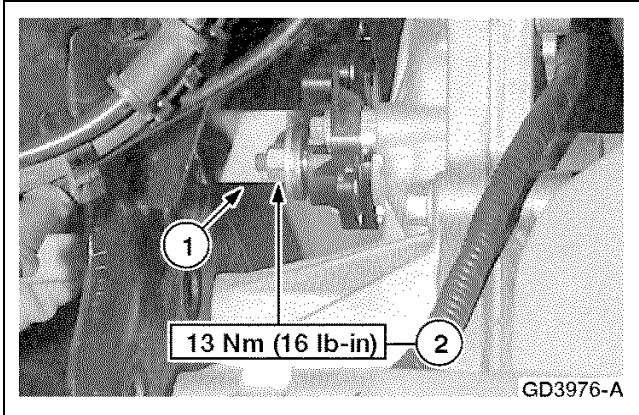
**REMOVAL AND INSTALLATION (Continued)**

5. Install the DTR sensor lever.
  - 1 Position the lever.
  - 2 Install the nut.

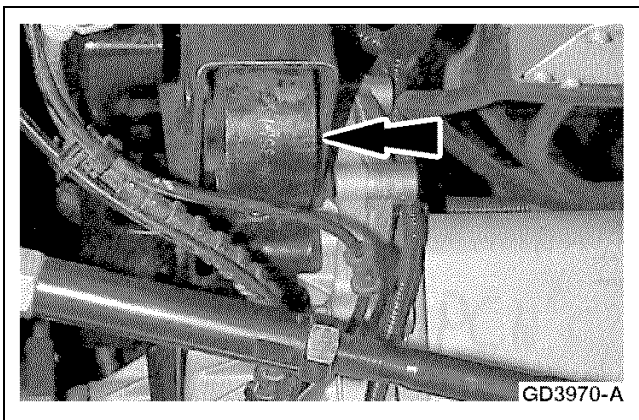

6. Position the motor/transaxle mount.

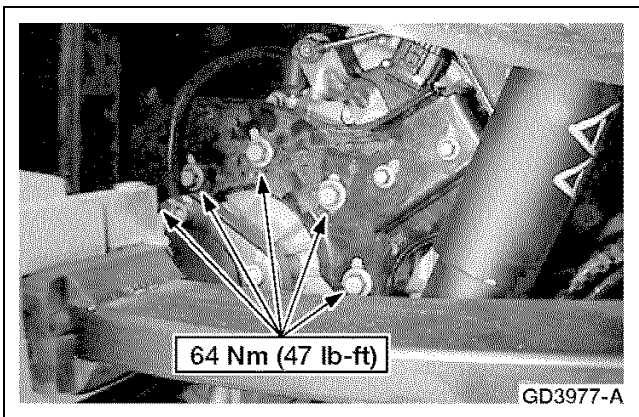

7. Install the five bracket to motor/transaxle bolts.
  - The motor/transaxle may have to be lowered or raised slightly to align the bracket bolt holes with the motor/transaxle.

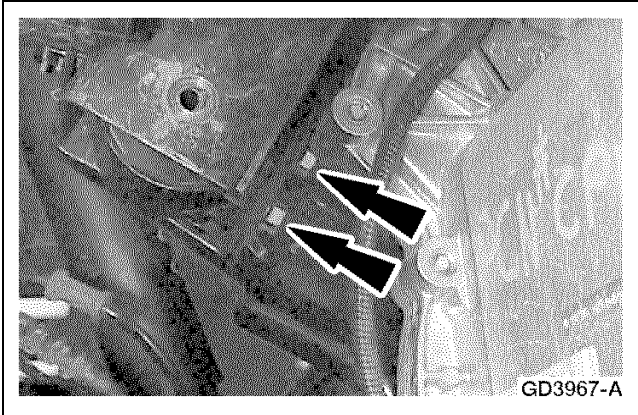
**REMOVAL AND INSTALLATION (Continued)**

8. Loosely install the two motor mount nuts.

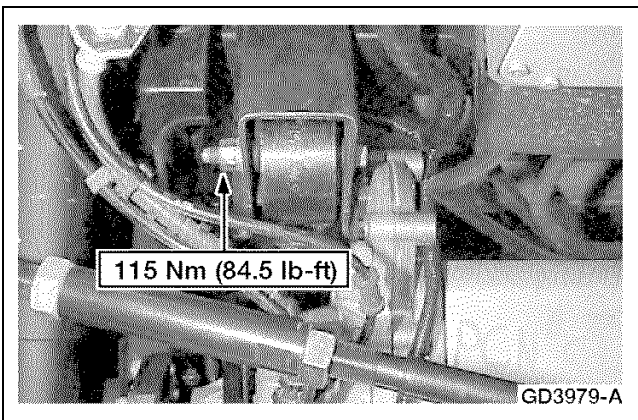

9. Install the motor mount through bolt.

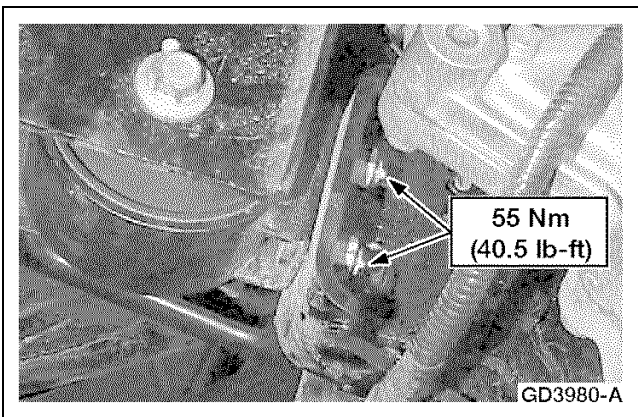

10. Tighten the two motor mount nuts.

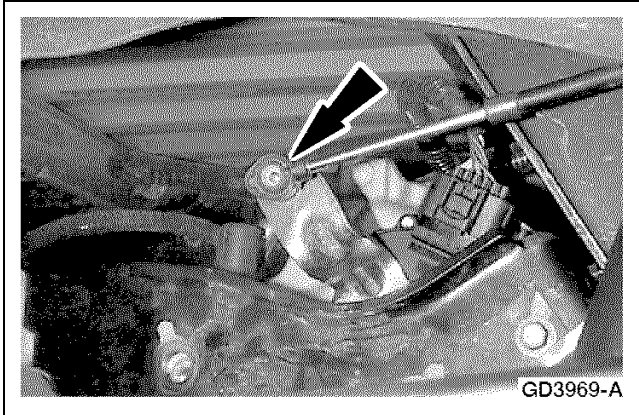
**REMOVAL AND INSTALLATION (Continued)**

11. Connect the shift cable.

12. Install the LH rear wheel.

13. Adjust the shift cable. Refer to [PRNDE Shifter Adjustment](#).

---

[Manual Table of Contents](#)

## SECTION 310-02 Acceleration Control

VEHICLE APPLICATION: Ranger EV

CONTENTS	PAGE
<b>SPECIFICATIONS</b> .....	<a href="#">310-02-2</a>
<b>DESCRIPTION AND OPERATION</b>	
Acceleration Control .....	<a href="#">310-02-2</a>
<b>DIAGNOSIS AND TESTING</b>	
Acceleration Control .....	<a href="#">310-02-3</a>
Electrical Schematic .....	<a href="#">310-02-3</a>
Inspection and Verification .....	<a href="#">310-02-3</a>
Pinpoint Tests .....	<a href="#">310-02-3</a>
Symptom Chart .....	<a href="#">310-02-3</a>
<b>REMOVAL AND INSTALLATION</b>	
Acceleration Position Sensor .....	<a href="#">310-02-6</a>
Acceleration Position Sensor —Postal Ranger EV .....	<a href="#">310-02-7</a>

## SPECIFICATIONS

### Torque Specifications—Electric Ranger EV

Description	Nm	Lb-In
Acceleration Position Sensor Bolt	10.5	93.5

### Torque Specifications—Postal Ranger EV

Description	Nm	Lb-Ft	Lb-In
Accelerator pedal bolt	15	—	11

## DESCRIPTION AND OPERATION

### Acceleration Control

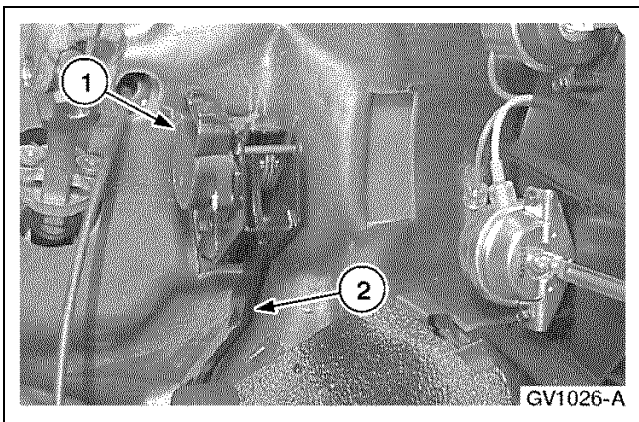

Item	Description
1	Acceleration Position Sensor (APS)
2	Acceleration Pedal

**NOTE:** Electric Ranger shown, Postal Ranger EV similar.

The Electric Vehicle uses an acceleration position sensor (APS) to monitor driver demands for acceleration. The APS is mounted to the acceleration pedal bracket and moves in direct relation to the throttle pedal. Three potentiometers are positioned inside the control to read different slopes for accelerator position calculation. The information from the potentiometers is fed to the traction inverter module (TIM), which controls the motor/transaxle accordingly.

## DIAGNOSIS AND TESTING

### Acceleration Control

#### Diagnostic Trouble Code (DTC) Definition

The following DTCs relate to the acceleration position sensor (APS):

- DTC C1750 Acceleration Position Sensor Out Of Range
  - The accelerator position sensor (APS) is mounted to the accelerator pedal assembly and consists of three integrated sensors that indicate the accelerator pedal position to the traction inverter module (TIM). DTC C1750 is set when one or more of these sensors are out of range. If this failure occurs, the malfunction indicator lamp (MIL) illuminates, the power limit warning indicator flashes, and the motor is capable of only creep torque (limited power).

- DTC C1855 Acceleration Position Sensor Conflict
  - DTC C1855 is set if there is a conflict between the three accelerator position sensor (APS) signals. It may also occur if there is an out of range condition for the sensors (DTC C1750). If this failure occurs, the malfunction indicator lamp (MIL) illuminates, the power limit warning indicator flashes, and the motor is capable of only creep torque (limited power).

#### Electrical Schematic

Refer to **Electrical and Vacuum Troubleshooting Manual, Cell 26, Motor/Transaxle Control** for schematic and connector information.

#### Inspection and Verification

Refer to [Section 100-07](#).

### Symptom Chart

#### Symptom Chart

Condition	Possible Sources	Action
<ul style="list-style-type: none"> <li>• DTC C1750 Acceleration Position Sensor (APS) Out of Range</li> </ul>	<ul style="list-style-type: none"> <li>• Traction inverter module (TIM).</li> <li>• Circuit(s).</li> <li>• acceleration position sensor (APS).</li> </ul>	<ul style="list-style-type: none"> <li>• GO to <a href="#">Pinpoint Test A</a>.</li> </ul>
<ul style="list-style-type: none"> <li>• DTC C1855 Acceleration Position Sensor (APS) Conflict</li> </ul>	<ul style="list-style-type: none"> <li>• Traction inverter module (TIM).</li> <li>• Circuit(s).</li> <li>• acceleration position sensor (APS).</li> </ul>	<ul style="list-style-type: none"> <li>• GO to <a href="#">Pinpoint Test B</a>.</li> </ul>

### Pinpoint Tests

#### Special Tool(s)

104-Pin Breakout Box (BOB) 418-049 (014-00950) or equivalent
BCM/TIM Breakout Box (BOB) Adapter Cable 418-F212
BCM/TIM Breakout Box (BOB) Overlay 418-F220

#### PINPOINT TEST A: DTC C1750 ACCELERATION POSITION SENSOR (APS) OUT OF RANGE

TEST STEP	ACTION TO TAKE
<b>A1 CHECK ACCELERATION POSITION SENSOR ONE (APS1) SIGNAL</b> <ul style="list-style-type: none"> <li>• With key ON, monitor the traction inverter module (TIM) PID AP1V.</li> </ul>	Yes = GO to A7.

(Continued)

**DIAGNOSIS AND TESTING (Continued)****PINPOINT TEST A: DTC C1750 ACCELERATION POSITION SENSOR (APS) OUT OF RANGE**

TEST STEP	ACTION TO TAKE
<ul style="list-style-type: none"> <li>Depress the accelerator pedal.</li> <li><b>Does the AP1V PID vary within the range of 0.25 and 4.85 volts?</b></li> </ul>	No = GO to <b>A2</b> .
<b>A2 CHECK CIRCUITS 3835 (Y/W), 3836 (Y/LB), AND 3837 (GY/Y) (TO APS1) FOR OPEN(S)</b> <ul style="list-style-type: none"> <li>Connect 104-Pin Breakout Box (BOB) to traction inverter module (TIM) C4998 and C4999, using the BCM/TIM BOB Adapter Cable and Overlay; leave the TIM disconnected.</li> <li>With key OFF, disconnect acceleration position sensor (APS) C2995 and measure the resistance of the Y/LB wire between pin G on APS C2995 and BOB pin B5.</li> <li>With key OFF, measure the resistance of the GY/Y wire between pin A on APS C2995 and BOB pin B3.</li> <li>With key OFF, measure the resistance of the Y/W wire between pin F on APS C2995 and BOB pin B4.</li> <li><b>Are the resistances less than 5 ohms?</b></li> </ul>	Yes = GO to <b>A3</b> .  No = REPAIR the wire(s) in question.
<b>A3 CHECK CIRCUITS 3835 (Y/W) AND 3836 (Y/LB) (TO APS1) FOR SHORT(S) TO GROUND</b> <ul style="list-style-type: none"> <li>With key OFF, measure the resistance between BOB pins B4, B5 and ground (BOB pin A29).</li> <li><b>Are the resistances greater than 10,000 ohms?</b></li> </ul>	Yes = GO to <b>A4</b> .  No = REPAIR the wire(s) in question.
<b>A4 CHECK CIRCUITS 3835 (Y/W) AND 3836 (Y/LB) (TO APS1) FOR SHORT(S) TO POWER</b> <ul style="list-style-type: none"> <li>With key ON, measure the voltage between BOB pins B4, B5 and ground (BOB pin A29).</li> <li><b>Are any of the voltages greater than 0 volts?</b></li> </ul>	Yes = REPAIR the wire(s) in question. No = GO to <b>A5</b> .
<b>A5 CHECK APS1 REFERENCE VOLTAGE</b> <ul style="list-style-type: none"> <li>With key OFF, connect TIM to BOB; leave BOB connected to TIM C4998 and C4999.</li> <li>With key ON, measure the voltage between BOB pin B5 and ground (BOB pin A29).</li> <li><b>Is the voltage between 4.9 and 5.1 volts?</b></li> </ul>	Yes = GO to <b>A6</b> .  No = REPLACE the TIM. REFER to <a href="#">Section 303-14</a> .
<b>A6 CHECK APS1 SIGNAL</b> <ul style="list-style-type: none"> <li>With key OFF, reconnect APS C2995.</li> <li>With key ON, measure the voltage between BOB pins B3 and B4 while depressing the accelerator pedal from idle to wide open throttle (WOT).</li> <li><b>Does the voltage vary within the range of 0.25 and 4.85 volts?</b></li> </ul>	Yes = REPLACE the TIM. REFER to <a href="#">Section 303-14</a> . No = REPLACE the APS.
<b>A7 CHECK ACCELERATION POSITION SENSOR TWO (APS2) SIGNAL</b> <ul style="list-style-type: none"> <li>With key ON, monitor the TIM PID AP2V.</li> <li>Depress the accelerator pedal.</li> <li><b>Does the AP2V PID vary within the range of 4.75 and 0.15 volts?</b></li> </ul>	Yes = GO to <b>A13</b> . No = GO to <b>A8</b> .
<b>A8 CHECK CIRCUITS 3010 (T), 3011 (BK/O), AND 3012 (W) (TO APS2) FOR OPEN(S)</b> <ul style="list-style-type: none"> <li>Connect 104-Pin Breakout Box (BOB) to TIM C4998 and C4999, using the BCM/TIM BOB Adapter Cable and Overlay; leave the TIM disconnected.</li> </ul>	Yes = GO to <b>A9</b> .

(Continued)



**DIAGNOSIS AND TESTING (Continued)****PINPOINT TEST A: DTC C1750 ACCELERATION POSITION SENSOR (APS) OUT OF RANGE**

TEST STEP	ACTION TO TAKE
<ul style="list-style-type: none"> <li>• With key OFF, disconnect acceleration position sensor (APS) C2995 and measure the resistance of the T wire between pin D on APS C2995 and BOB pin B11.</li> <li>• With key OFF, measure the resistance of the BK/O wire between pin B on APS C2995 and BOB pin B9.</li> <li>• With key OFF, measure the resistance of the W wire between pin C on APS C2995 and BOB pin B10.</li> <li>• <b>Are the resistances less than 5 ohms?</b></li> </ul>	No = REPAIR the wire(s) in question.
<b>A9 CHECK CIRCUITS 3010 (T) AND 3012 (W) (TO APS2) FOR SHORT(S) TO GROUND</b> <ul style="list-style-type: none"> <li>• With key OFF, measure the resistance between BOB pins B4, B5 and ground (BOB pin A29).</li> <li>• <b>Are the resistances greater than 10,000 ohms?</b></li> </ul>	Yes = GO to <b>A10</b> .  No = REPAIR the wire(s) in question.
<b>A10 CHECK CIRCUITS 3010 (T) AND 3012 (W) (TO APS2) FOR SHORT(S) TO POWER</b> <ul style="list-style-type: none"> <li>• With key ON, measure the voltage between BOB pins B10, B11 and ground (BOB pin A29).</li> <li>• <b>Are any of the voltages greater than 0 volts?</b></li> </ul>	Yes = REPAIR the wire(s) in question.  No = GO to <b>A11</b> .
<b>A11 CHECK APS2 REFERENCE VOLTAGE</b> <ul style="list-style-type: none"> <li>• With key OFF, connect TIM to BOB; leave BOB connected to TIM C4998 and C4999.</li> <li>• With key ON, measure the voltage between BOB pin B11 and ground (BOB pin A29).</li> <li>• <b>Is the voltage between 4.9 and 5.1 volts?</b></li> </ul>	Yes = GO to <b>A12</b> .  No = REPLACE the TIM. REFER to <a href="#">Section 303-14</a> .
<b>A12 CHECK APS2 SIGNAL</b> <ul style="list-style-type: none"> <li>• With key OFF, reconnect APS C2995.</li> <li>• With key ON, measure the voltage between BOB pins B9 and B10 while depressing the accelerator pedal from idle to wide open throttle (WOT).</li> <li>• <b>Does the voltage vary within the range of 4.00 and 0.15 volts?</b></li> </ul>	Yes = REPLACE the TIM. REFER to <a href="#">Section 303-14</a> .  No = REPLACE the APS.
<b>A13 CHECK ACCELERATION POSITION SENSOR THREE (APS3) SIGNAL</b> <ul style="list-style-type: none"> <li>• With key ON, monitor the traction inverter module (TIM) PID AP3V.</li> <li>• Depress the accelerator pedal.</li> <li>• <b>Does the AP3V PID vary within the range of 4.00 and 1.56 volts?</b></li> </ul>	Yes = System OK. CHECK wiring for intermittent connections.  No = GO to <b>A14</b> .
<b>A14 CHECK CIRCUITS 3013 (GY/BK), 3014 (BK/W), AND 3015 (W/R) (TO APS3) FOR OPEN(S)</b> <ul style="list-style-type: none"> <li>• Connect 104-Pin Breakout Box (BOB) to traction inverter module (TIM) C4998 and C4999, using the BCM/TIM BOB Adapter Cable and Overlay; leave the TIM disconnected.</li> <li>• With key OFF, disconnect acceleration position sensor (APS) C2995 and measure the resistance of the GY/BK wire between pin E on APS C2995 and BOB pin B17.</li> <li>• With key OFF, measure the resistance of the BK/W wire between pin J on APS C2995 and BOB pin B15.</li> <li>• With key OFF, measure the resistance of the W/R wire between pin K on APS C2995 and BOB pin B16.</li> <li>• <b>Are the resistances less than 5 ohms?</b></li> </ul>	Yes = GO to <b>A15</b> .  No = REPAIR the wire(s) in question.
<b>A15 CHECK CIRCUITS 3013 (GY/BK) AND 3015 (W/R) (TO APS3) FOR SHORT(S) TO GROUND</b>	

(Continued)

**DIAGNOSIS AND TESTING (Continued)****PINPOINT TEST A: DTC C1750 ACCELERATION POSITION SENSOR (APS) OUT OF RANGE**

TEST STEP	ACTION TO TAKE
<ul style="list-style-type: none"> <li>With key OFF, measure the resistance between BOB pins B16, B17 and ground (BOB pin A29).</li> <li><b>Are the resistances greater than 10,000 ohms?</b></li> </ul>	Yes = GO to <b>A16</b> . No = REPAIR the wire(s) in question.
<b>A16 CHECK CIRCUITS 3013 (GY/BK) AND 3015 (W/R) (TO APS3) FOR SHORT(S) TO POWER</b> <ul style="list-style-type: none"> <li>With key ON, measure the voltage between BOB pins B16, B17 and ground (BOB pin A29).</li> <li><b>Are any of the voltages greater than 0 volts?</b></li> </ul>	Yes = REPAIR the wire(s) in question. No = GO to <b>A17</b> .
<b>A17 CHECK APS3 REFERENCE VOLTAGE</b> <ul style="list-style-type: none"> <li>With key OFF, connect TIM to BOB; leave BOB connected to TIM C4998 and C4999.</li> <li>With key ON, measure the voltage between BOB pin B17 and ground (BOB pin A29).</li> <li><b>Is the voltage between 4.9 and 5.1 volts?</b></li> </ul>	Yes = GO to <b>A18</b> . No = REPLACE the TIM. REFER to <a href="#">Section 303-14</a> .
<b>A18 CHECK APS3 SIGNAL</b> <ul style="list-style-type: none"> <li>With key OFF, reconnect APS C2995.</li> <li>With key ON, measure the voltage between BOB pins B15 and B16 while depressing the accelerator pedal from idle to wide open throttle (WOT).</li> <li><b>Does the voltage vary within the range of 4.00 and 1.56 volts?</b></li> </ul>	Yes = REPLACE the TIM. REFER to <a href="#">Section 303-14</a> . No = REPLACE the APS.

**PINPOINT TEST B: DTC C1855 ACCELERATION POSITION SENSOR (APS) CONFLICT**

TEST STEP	ACTION TO TAKE
<b>B1 CHECK FOR OTHER DIAGNOSTIC TROUBLE CODES (DTCs)</b> <ul style="list-style-type: none"> <li><b>Does DTC C1750 Acceleration Position Sensor Out of Range occur along with DTC C1855?</b></li> </ul>	Yes = GO to <a href="#">Pinpoint Test A</a> . No = GO to <b>B2</b> .
<b>B2 CHECK CIRCUITS 3835 (Y/W), 3012 (W), AND 3015 (W/R) FOR SHORT(S)</b> <ul style="list-style-type: none"> <li>Connect 104-Pin Breakout Box (BOB) to traction inverter module (TIM) C4998 and C4999, using the BCM/TIM BOB Adapter Cable and Overlay; leave the TIM disconnected.</li> <li>With key OFF, disconnect acceleration position sensor (APS) C2995 and measure the resistance between BOB pins B4 and B10, BOB pins B4 and B16, and BOB pins B10 and B16.</li> <li><b>Are any of the resistances less than 5 ohms?</b></li> </ul>	Yes = REPAIR the wire(s) in question. No = REPLACE the APS.

**REMOVAL AND INSTALLATION****Acceleration Position Sensor****Removal**

- NOTE:** The acceleration position sensor (APS) is mounted on the lower driver side bulkhead and is connected to the throttle pedal. Disconnect the electrical connector.

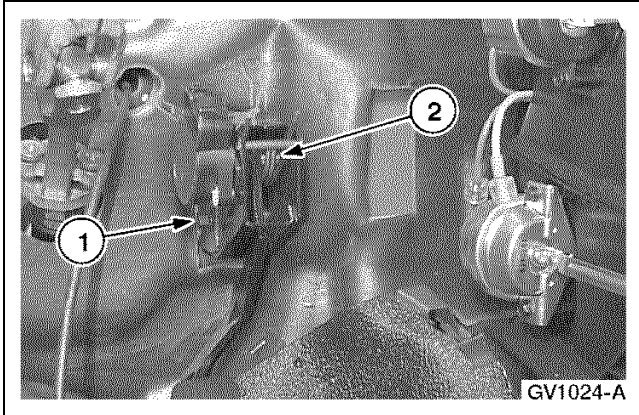
**REMOVAL AND INSTALLATION (Continued)**

2. Remove the position sensor.
  - 1 Remove the bolt.
  - 2 Swing the sensor up and off the clip and remove the sensor.

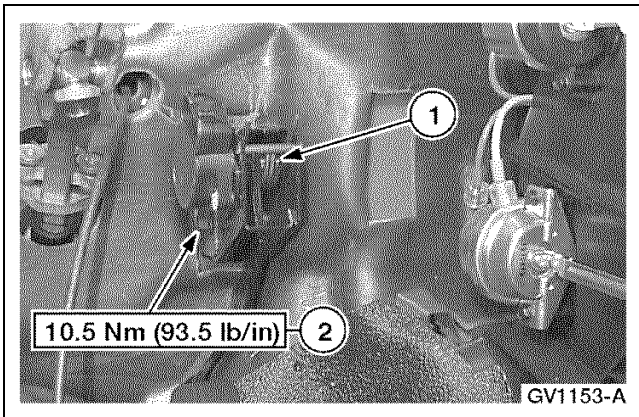
**Installation**

1. Install the position sensor.
  - 1 Position the sensor on the clip and swing it into position.
  - 2 Install the bolt.

2. Connect the electrical connector.

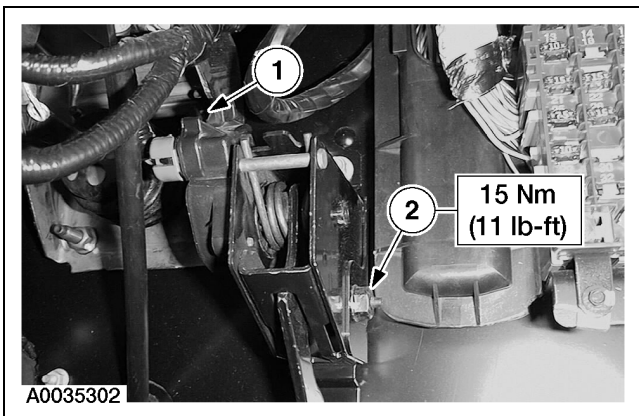
**Acceleration Position Sensor —Postal Ranger EV****Removal and Installation**

1. **NOTE:** The acceleration position sensor is serviced as an assembly with the accelerator pedal.  
Remove the accelerator pedal assembly.
  - 1 Disconnect the electrical connector.
  - 2 Remove the bolt.

---

**REMOVAL AND INSTALLATION (Continued)**

2. To install, reverse the removal procedure.

# GROUP

# 4

# Electrical

---

SECTION TITLE	PAGE
Air Distribution and Filtering .....	412-01-1
Heating and Ventilation .....	412-02-1
Air Conditioning .....	412-03-1
Control Components .....	412-04-1
Instrument Cluster .....	413-01-1
Auxiliary Battery Charging.....	414-02-1
High Voltage/Traction Battery .....	414-03A-1
High Voltage/Traction Battery —Nickel Metal Hydride .....	414-03B-1
Module Communications Network.....	418-00-1

---

## SECTION 412-01 Air Distribution and Filtering

VEHICLE APPLICATION: Ranger EV

CONTENTS	PAGE
<b>SPECIFICATIONS</b> .....	412-01-2
<b>DESCRIPTION AND OPERATION</b>	
Air Distribution and Filtering .....	412-01-2
<b>REMOVAL AND INSTALLATION</b>	
Air Filter.....	412-01-2
Air Filter —Postal Ranger EV .....	412-01-7

## SPECIFICATIONS

### Torque Specifications

Description	Nm	Lb-Ft	Lb-In
Blower Motor Screws	1.75	15.5	—
Reservoir Bolts and Nuts	7	62.5	—
ABS Control Bracket Bolts	11	—	8

## DESCRIPTION AND OPERATION

### Air Distribution and Filtering

The heating and cooling system on the Electric Ranger uses an air filter to clean the air before it is allowed to pass through the heater core. The heater core uses electrical resistance to heat the air. Due to the high temperatures associated with the heater core, proper air filtration is essential.

The air filter is made from a pleated woven material that offers minimal restriction to airflow. The filter is located in the evaporator assembly behind the blower motor. To ensure maximum climate control performance, the filter must be changed annually.

## REMOVAL AND INSTALLATION

### Air Filter

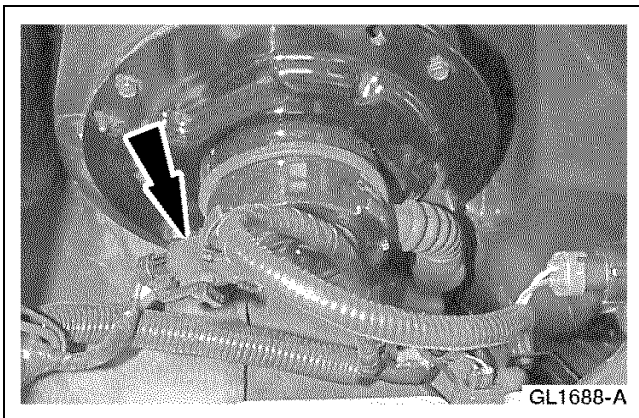

1. Disconnect the blower motor electrical connector.

## REMOVAL AND INSTALLATION (Continued)

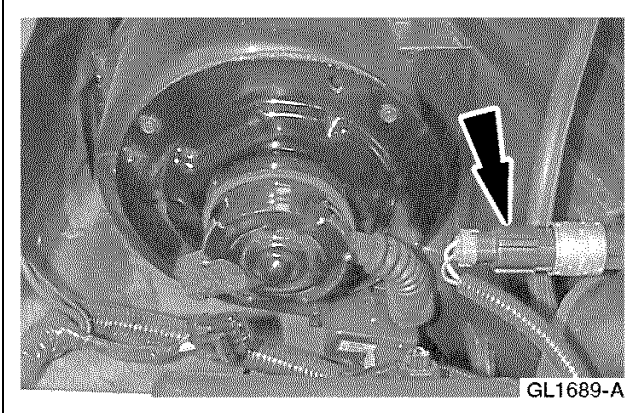

2. Disconnect the A/C electrical connector.

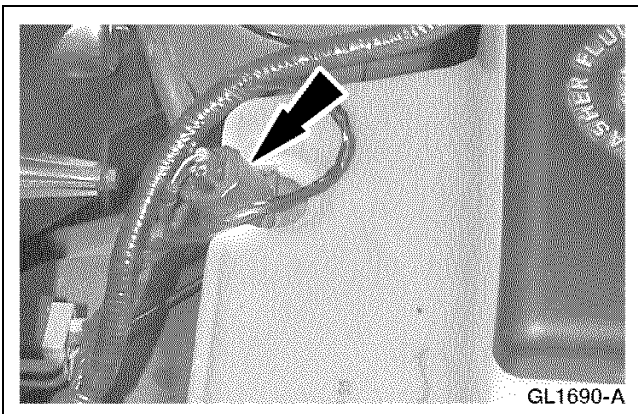

3. Disconnect the windshield solvent pump electrical connector.

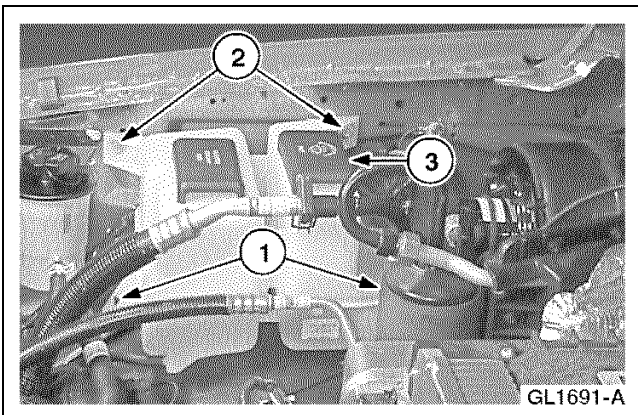

4. Position the reservoirs.
  - 1 Remove the nuts.
  - 2 Remove the bolts.
  - 3 Position the reservoir toward the front of the vehicle.

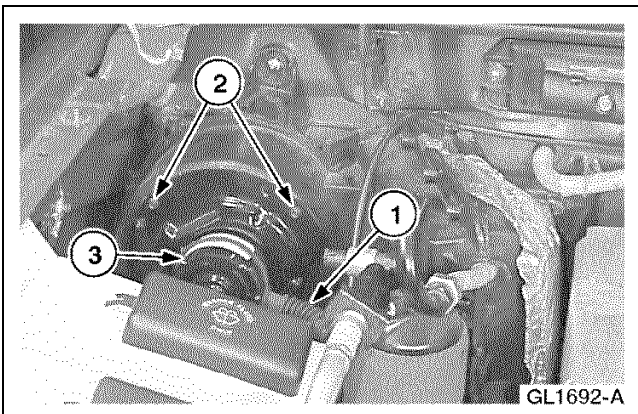

5. Remove the blower motor.
  - 1 Disconnect the blower motor air inlet tube.
  - 2 Remove the four screws.
  - 3 Remove the motor.

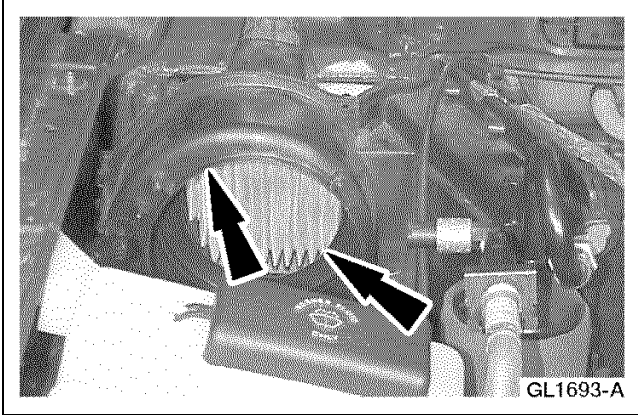
**REMOVAL AND INSTALLATION (Continued)**

6. Pry the air filter arms from behind the housing tabs, which are located at the three and ten o'clock positions.

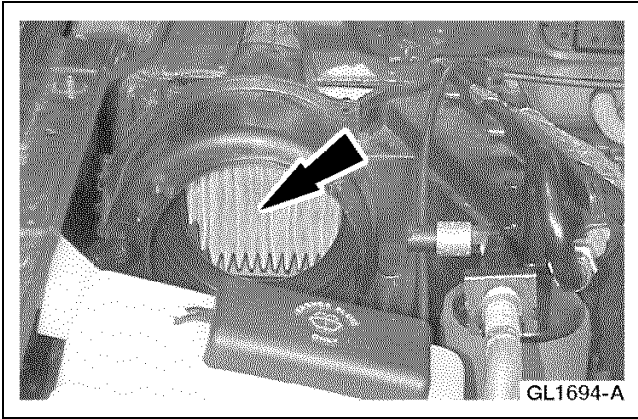

7. Remove the air filter.
  - Grasp the air filter at the 3 and 9 o'clock positions by the pleats and fold the filter in half.
  - Turn the filter counterclockwise until the filter is at the 10 and 4 o'clock positions.
  - Tip the 10 o'clock position of the filter towards the outside of the housing and pull the filter out through the blower motor opening.

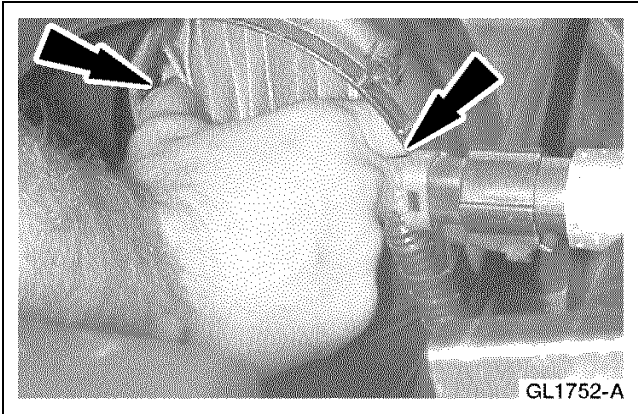
**Installation**

1. Grasp the new filter at the 3 and 9 o'clock positions and squeeze the outer edges to form a "U" shape.
2. Turn the filter counterclockwise until it is in the 10 and 4 o'clock position.
3. Insert at an angle by leading with the 4 o'clock position through the blower motor opening.
4. Once the filter is in the housing, turn it to the 12 and 6 o'clock positions. This will orient the filter correctly in the housing. Release the filter.



## REMOVAL AND INSTALLATION (Continued)

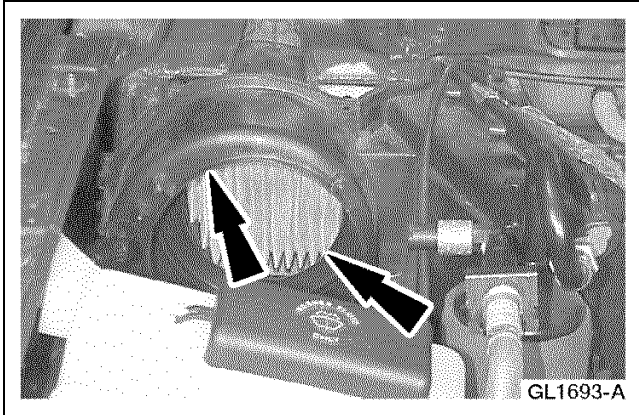

5. Snap the filter arms in behind the housing tabs.

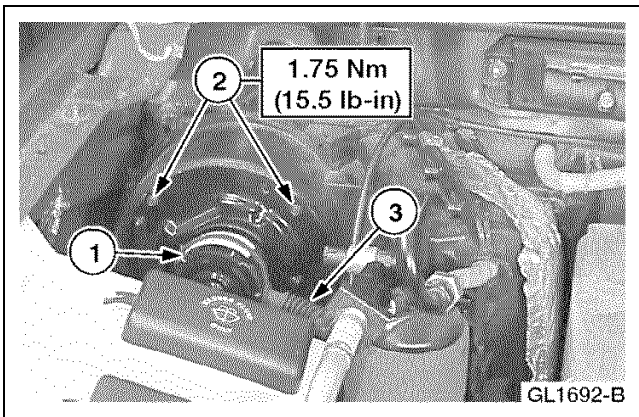

6. Lightly pull the filter towards the blower motor opening to properly locate the filter.

7. **⚠ CAUTION: Overtightening of the blower screws will result in damage to the plastic housing.**

Install the blower motor.

- 1 Position the blower.
- 2 Install the four screws.
- 3 Connect the blower motor air inlet tube.

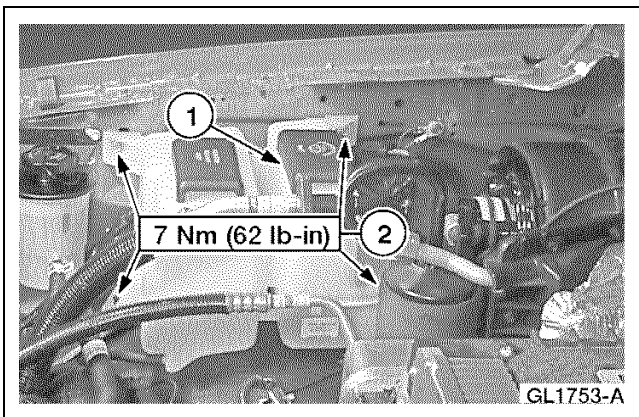

8. Install the reservoir.
  - 1 Position the reservoir.
  - 2 Install the nuts and bolts.

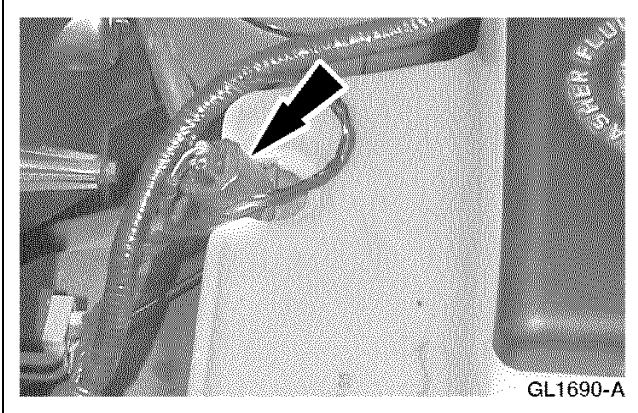
**REMOVAL AND INSTALLATION (Continued)**

9. Connect the windshield solvent pump electrical connector.

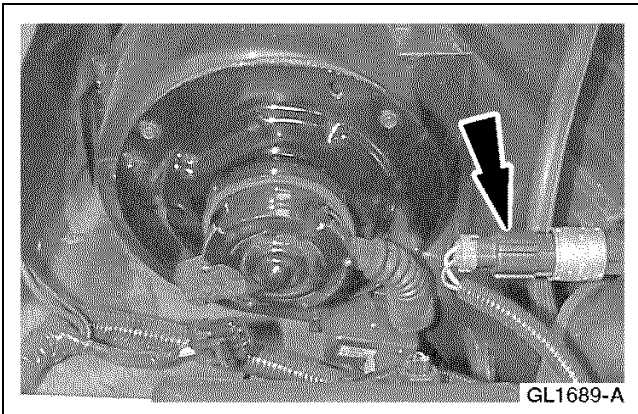

10. Connect the A/C electrical connector.

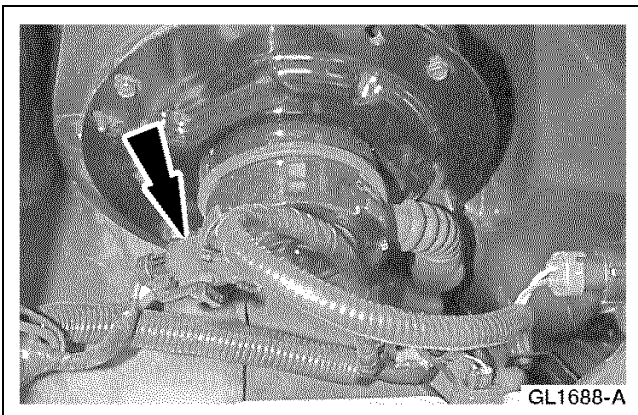

11. Connect the blower motor electrical connector.

## REMOVAL AND INSTALLATION (Continued)

### Air Filter —Postal Ranger EV

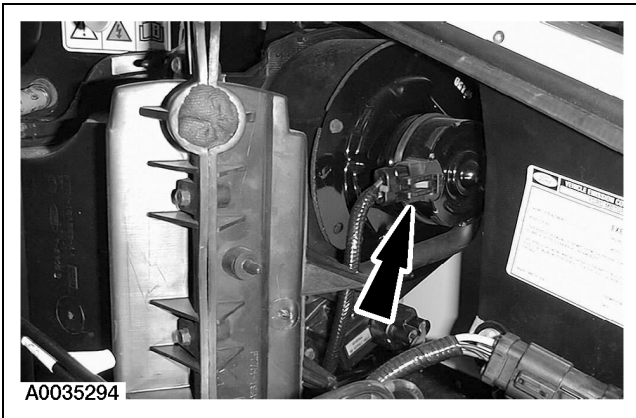

1. Disconnect the blower motor electrical connector.

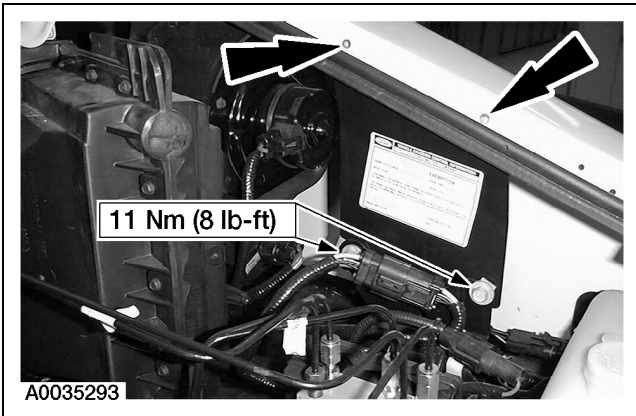

2. Remove the Anti-lock Brake System (ABS) control unit bracket.

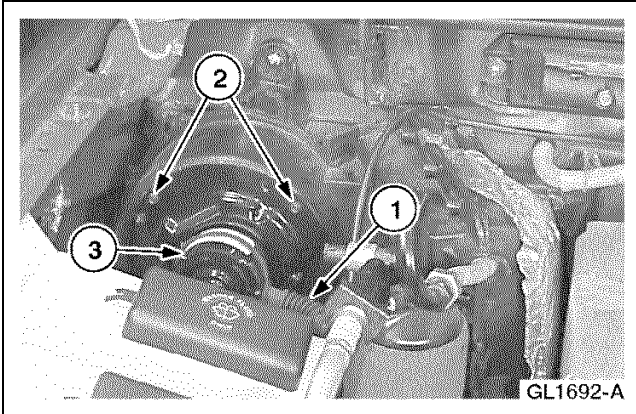

3. **NOTE:** Electric Ranger shown, Postal Ranger EV similar.  
Remove the blower motor.
  - 1 Disconnect the blower motor air inlet tube.
  - 2 Remove the four screws.
  - 3 Remove the motor.

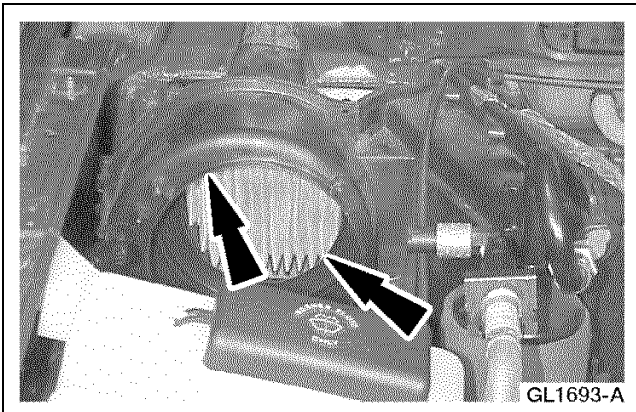

4. **NOTE:** Electric Ranger shown, Postal Ranger EV similar.  
Pry the air filter arms from behind the housing tabs, which are located at the three and ten o'clock positions.

## REMOVAL AND INSTALLATION (Continued)

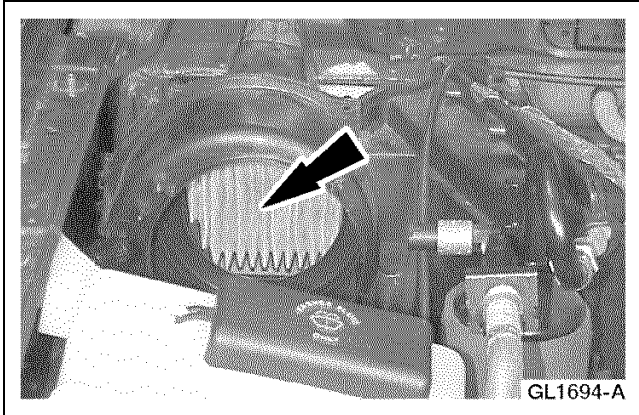

5. **NOTE:** Electric Ranger shown, Postal Ranger EV similar.

Remove the air filter.

- Grasp the air filter at the 3 and 9 o'clock positions by the pleats and fold the filter in half.
- Turn the filter counterclockwise until the filter is at the 10 and 4 o'clock positions.
- Tip the 10 o'clock position of the filter towards the outside of the housing and pull the filter out through the blower motor opening.

### Installation

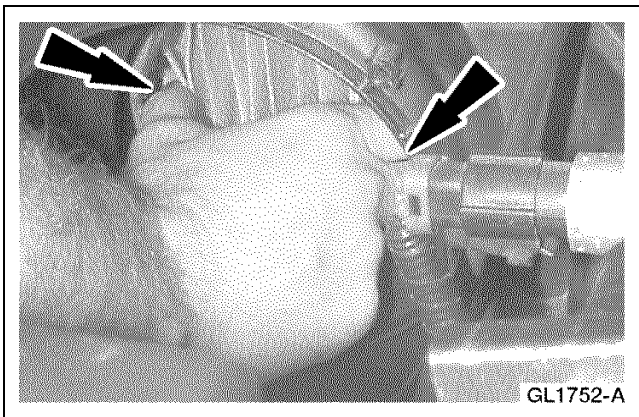

1. **NOTE:** Electric Ranger shown, Postal Ranger EV similar.

Grasp the new filter at the 3 and 9 o'clock positions and squeeze the outer edges to form a "U" shape.

2. Turn the filter counterclockwise until it is in the 10 and 4 o'clock position.
3. Insert at an angle by leading with the 4 o'clock position through the blower motor opening.
4. Once the filter is in the housing, turn it to the 12 and 6 o'clock positions. This will orient the filter correctly in the housing. Release the filter.

## REMOVAL AND INSTALLATION (Continued)

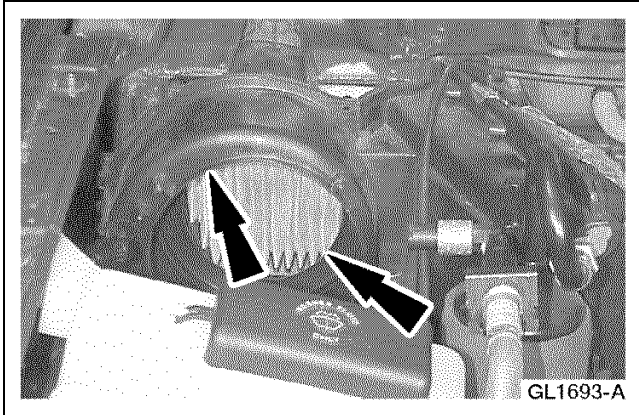

5. **NOTE:** Electric Ranger shown, Postal Ranger EV similar.  
Snap the filter arms in behind the housing tabs.

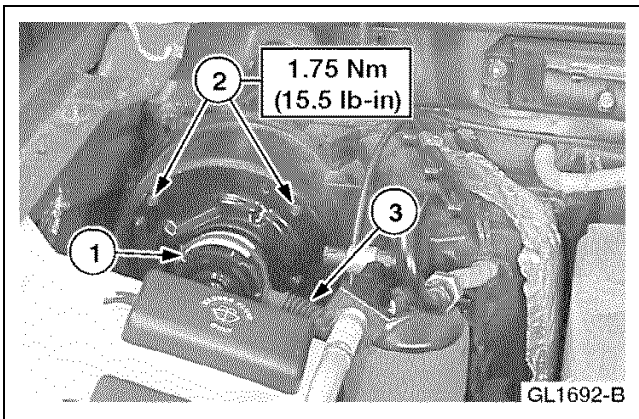

6. Lightly pull the filter towards the blower motor opening to properly locate the filter.

7. **⚠ CAUTION: Overtightening of the blower screws will result in damage to the plastic housing.**

**NOTE:** Electric Ranger shown, Postal Ranger EV similar.

Install the blower motor.

- 1 Position the blower.
- 2 Install the four screws.
- 3 Connect the blower motor air inlet tube.

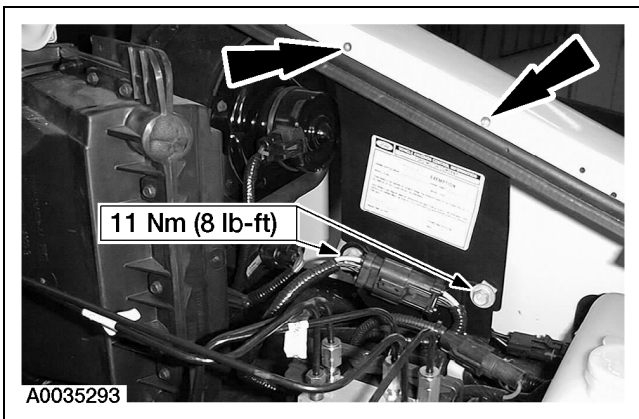

8. Install the ABS control unit bracket.

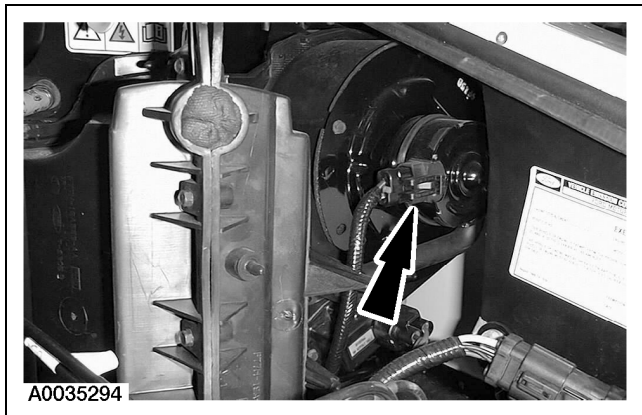
**REMOVAL AND INSTALLATION (Continued)**

9. Connect the blower motor electrical connector.

---

 Manual Table of Contents

## SECTION 412-02 Heating and Ventilation

VEHICLE APPLICATION: Ranger EV

CONTENTS	PAGE
<b>SPECIFICATIONS</b> .....	412-02-2
<b>DESCRIPTION AND OPERATION</b>	
Heating/Defrosting .....	412-02-2
Heating/Defrosting —Postal Ranger EV .....	412-02-2
<b>DIAGNOSIS AND TESTING</b>	
Heating/Defrosting/Ventilation System .....	412-02-3
Electrical Schematic .....	412-02-5
Inspection and Verification .....	412-02-5
Pinpoint Tests .....	412-02-7
Symptom Chart .....	412-02-5
<b>REMOVAL AND INSTALLATION</b>	
PTC Heater Core —Electric Ranger .....	412-02-32
PTC Heater Core —Postal Ranger EV .....	412-02-36

## SPECIFICATIONS

### Torque Specifications

Description	Nm	Lb/In
Evaporator Housing Nuts	4	35.5
Heater Plenum Retaining Nuts	4	35.5
High-Voltage Power Distribution Box Cover Screws	2	18

(Continued)

### Torque Specifications

Description	Nm	Lb/In
Positive Temperature Coefficient Heater Core Cover Screws	3	26.5
Reservoir Nuts and Bolts	7	62

## DESCRIPTION AND OPERATION

### Heating/Defrosting

A positive temperature coefficient (PTC) heater is used to heat the passenger compartment and defrost the windshield on the Electric Ranger. The PTC heater uses a two-stage electrical resistance heater that operates on high-voltage direct current (DC). At temperatures above 4°C (40°F), the first stage of the PTC heater will operate to heat the passenger compartment. At temperatures below 4° (40°F), both stages of the PTC heater will operate.

The PTC heater is located in the standard Ranger heater core location, and high-voltage DC is fed to the PTC heater by the PTC switching module. The PTC heater is equipped with an overtemperature sensor, and the air that is circulated through the heater is filtered through an climate control filter to prevent possible ignition of dirt or dust build-up on the heater. The heater will maintain the passenger compartment at a maximum of 26.5°C (85°F) in order to conserve traction battery power.

### Heating/Defrosting —Postal Ranger EV

A positive temperature coefficient (PTC) heater is used to heat the passenger compartment and defrost the windshield on the Postal Ranger EV. The PTC heater uses a two-stage electrical resistance heater that operates on high-voltage direct current (DC). At temperatures above 4°C (40°F), the first stage of the PTC heater will operate to heat the passenger compartment. At temperatures below 4° (40°F), both stages of the PTC heater will operate.

The PTC heater is located in the standard Ranger heater core assembly located on the LH side of the dash panel. High-voltage DC is fed to the PTC heater by the PTC switching module. The PTC heater is equipped with an overtemperature sensor, and the air that is circulated through the heater is filtered through an unique climate control filter to prevent possible ignition of dirt or dust build-up on the heater. The heater will maintain the passenger compartment at a maximum of 26.5°C (85°F) in order to conserve traction battery power.

The Postal Ranger EV has an unique feature called a Pre-Heat Function. The pre-heat function allows for heating/defrosting while the vehicle is in the KEY-OFF position to help conserve battery energy. This feature will operate when the vehicle is connected to the charging station and the outside temperature is 18°C (64°F) or below. The button for pre-heat is located to the left of the heater controls, above the recirculation button. To activate, push the button once. Heating is limited to 30 minutes of operation per activation. This function will automatically default the temperature control to full heat and set the fan speed. The fan speed is dependent on the temperature inside the vehicle. Direction of airflow can be controlled using the mode selector knob. While the pre-heat function is on, the vehicle will be in recirculation mode. To turn the pre-heat off, disconnect the vehicle from the charging station, put the vehicle in the KEY-ON position or wait until the 30 minutes have passed.



## DIAGNOSIS AND TESTING

### Heating/Defrosting/Ventilation System

#### Diagnostic Trouble Code (DTC) Definition

The following DTCs relate to the heating/defrosting/ventilation system:

- DTC B1238 Over Temperature Fault
  - The positive temperature coefficient (PTC) switching module uses an overtemperature switch that is mounted on the heater plenum assembly to monitor the temperature of the PTC heater cores. The PTC overtemperature switch is a normally closed switch that opens when an overtemperature condition occurs. The switch is set to open at 93°C-100°C (199°F-212°F). If the switch opens, the PTC switching module pulls the overtemperature fault line to the interface adapter assembly (IAA) module low (0 volts), and the IAA module sets DTC B1238.
- DTC B1249 Blend Door Failure
  - The interface adapter assembly (IAA) module monitors the range of blend door position. The IAA module sets DTC B1249 if it detects the blend door is not moving for 30 seconds of applied voltage or senses the blend door feedback to be less than 0.15 volts or greater than 4.85 volts. The IAA module also sets DTC B1249 if the autocalibration routine of the blend door operation sets the full warm position at less than three volts or the full cool position at more than two volts.
- DTC B1250 Air Temperature Internal Sensor Circuit Failure
  - The interface adapter assembly (IAA) module uses the in-car temperature sensor to monitor the temperature of the passenger compartment. If the in-car temperature sensor reads less than -40°C (-40°F) or greater than 90°C (194°F) for 30 seconds, the IAA module sets DTC B1250 and assumes the temperature to be 25°C (77°F).
- DTC B1254 Air Temperature External Sensor Circuit Failure
  - The interface adapter assembly (IAA) module uses the ambient temperature sensor to monitor the temperature of the outside air. If the ambient temperature sensor reads less than -40°C (-40°F) or greater than 90°C (194°F) for 30 seconds, the IAA module sets DTC B1254 and assumes the temperature to be 215°C (419°F).
- DTC C1776 Heater System Failure
  - The positive temperature coefficient (PTC) heater core consists of two cores (A and B). The PTC switching module drives core A, core B or both core A and core B depending on ignition key cycling and temperature. The PTC switching module switches between core A and core B between ignition key cycling and turns on both cores at low temperatures. If the core that is turned on by the PTC switching module is open or is in an overcurrent condition, the PTC switching module must see a time of 45-60 seconds on the suspect heater core before a DTC code can be set. Afterwards, the PTC Switching Module disables that core, switches to the other core, and pulls the interface adapter assembly (IAA) module control line for the faulted core low (0 volts). The IAA module sets DTC C1776 when it detects either control line (core A or core B) low. It is possible to see an intermittent NO-HEAT condition on one core.
- DTC C1779 Blower Switch Failure
  - The interface adapter assembly (IAA) module monitors the blower speed signals from the climate control blower switch. The IAA module sets DTC C1779 if it detects an invalid combination of the blower speed inputs for more than 30 seconds.

**DIAGNOSIS AND TESTING (Continued)**

- DTC C1780 Temperature Select Failure
  - The interface adapter assembly (IAA) module monitors the temperature control signal from the climate control temperature control potentiometer. The IAA module sets DTC C1780 if it detects the temperature command to be greater than 4.95 volts or less than 0.05 volts for more than 30 seconds.
- DTC B1857 Climate Control On/Off Switch Failure
  - The interface adapter assembly (IAA) module monitors the A/C present, system on, A/C on, and recirculation signals to determine if there is a climate control on/off switch failure. The IAA module determines if the vehicle is equipped with A/C by detecting an A/C present signal from the A/C inverter motor controller (IMC). The IAA module receives the A/C on and system on signals from the mode select switch and the recirculation signal from the fresh/recirculation select switch. The IAA module sets DTC B1857 if it detects an invalid combination of the inputs for more than 45 seconds.
- DTC U2015 Signal Link Fault (Non SCP)
  - During the 5 seconds after receiving 12-volt power from the interface adapter assembly (IAA) module, the positive temperature coefficient (PTC) switching module carries out a power on self test (POST) and outputs a 1.5 second-long pulse signal over the overtemperature fault line to the IAA module to indicate it passed the POST. If the IAA module does not receive this pulse, it will turn off the 12-volt power for 0.5 seconds and retry up to 3 times per ignition key cycle. If all three attempts at powering the PTC switching module fail, the IAA module assumes the PTC switching module failed its POST and sets DTC U2015. The IAA module also sets DTC U2015 if the PTC switching module detects an internal short and pulls the short fault line to the IAA module low (0 volts).
- DTC B2513 Blower (Fan) Circuit Failure
  - The interface adapter assembly (IAA) module provides the pulse width modulation (PWM) control signal to the variable blower controller (VBC) and monitors the VBC feedback. The VBC contains an internal transistor relay that is used to drive the blower motor at high speed. The IAA module sets DTC B2513 if the blower motor relay is closed, the VBC internal relay is not closed or the VBC control signal is greater than 1%, and the VBC feedback is less than 1 volt for more than 30 seconds. If DTC B2513 is set and the blower motor operates, the VBC has failed. If DTC B2513 is set and the blower motor does not operate, but the coolant pump does, the blower motor circuit has failed. If DTC B2513 is set and the blower motor and coolant pump do not operate, the blower motor/coolant pump relay circuit has failed.
- DTC B2514 Blower (Fan) Circuit Short to Vbat
  - The interface adapter assembly (IAA) module provides the pulse width modulation (PWM) control signal to the variable blower controller (VBC) and monitors the VBC feedback. The IAA module sets DTC B2514 if the blower motor relay is open and the VBC feedback is greater than the auxiliary battery voltage minus 1 volt for more than 30 seconds.
- DTC B2515 Heater Blower Relay Circuit Failure
  - The interface adapter assembly (IAA) module provides the pulse width modulation (PWM) control signal to the variable blower controller (VBC) and monitors the VBC feedback. The VBC contains an internal transistor relay that is used to drive the blower motor at high speed. The IAA module sets DTC B2515 if the VBC internal transistor relay is closed and the VBC feedback is greater than 2 volts for more than 30 seconds.

**DIAGNOSIS AND TESTING (Continued)**

- DTC B2516 Blower Control Circuit Failure
  - The interface adapter assembly (IAA) module provides the pulse width modulation (PWM) control signal to the variable blower controller (VBC) and monitors the VBC feedback. The IAA module sets DTC B2516 if the blower motor relay is closed, the VBC control PWM is greater than 80% duty cycle for more than 30 seconds, and the VBC feedback is greater than the auxiliary battery voltage minus 2 volts.

**Electrical Schematic**

Refer to **Electrical and Vacuum Troubleshooting Manual, Cell 53, Heater or Cell 54, Air Conditioner/Heater** for schematic and connector information.

**Inspection and Verification**

Refer to [Section 100-07](#).

**Symptom Chart****Symptom Chart**

Condition	Possible Sources	Action
<ul style="list-style-type: none"> <li>• DTC B1238 Over Temperature Fault</li> </ul>	<ul style="list-style-type: none"> <li>• Positive temperature coefficient (PTC) heater overtemperature switch harness assembly.</li> <li>• Circuit(s).</li> <li>• Interface adapter assembly (IAA) module.</li> <li>• PTC switching module.</li> </ul>	<ul style="list-style-type: none"> <li>• GO to <a href="#">Pinpoint Test A</a>.</li> </ul>
<ul style="list-style-type: none"> <li>• DTC B1249 Blend Door Failure</li> </ul>	<ul style="list-style-type: none"> <li>• Blend door actuator.</li> <li>• Circuit(s).</li> <li>• Interface adapter assembly (IAA) module.</li> </ul>	<ul style="list-style-type: none"> <li>• GO to <a href="#">Pinpoint Test B</a>.</li> </ul>
<ul style="list-style-type: none"> <li>• DTC B1250 Air Temperature Internal Sensor Circuit Failure</li> </ul>	<ul style="list-style-type: none"> <li>• Interface adapter assembly (IAA) module.</li> <li>• Circuit(s).</li> <li>• In-car temperature sensor.</li> <li>• In-car temperature sensor hose and elbow.</li> </ul>	<ul style="list-style-type: none"> <li>• GO to <a href="#">Pinpoint Test C</a>.</li> </ul>
<ul style="list-style-type: none"> <li>• DTC B1254 Air Temperature External Sensor Circuit Failure</li> </ul>	<ul style="list-style-type: none"> <li>• Ambient temperature sensor.</li> <li>• Circuit(s).</li> <li>• Interface adapter assembly (IAA) module.</li> </ul>	<ul style="list-style-type: none"> <li>• GO to <a href="#">Pinpoint Test D</a>.</li> </ul>
<ul style="list-style-type: none"> <li>• DTC C1776 Heater System Failure</li> </ul>	<ul style="list-style-type: none"> <li>• Positive temperature coefficient (PTC) heater core.</li> <li>• Circuit(s).</li> <li>• PTC switching module.</li> <li>• Interface adapter assembly (IAA) module.</li> <li>• High-voltage power distribution box (HVPDB).</li> <li>• High-voltage PTC HTR fuse.</li> </ul>	<ul style="list-style-type: none"> <li>• GO to <a href="#">Pinpoint Test E</a>.</li> </ul>
<ul style="list-style-type: none"> <li>• DTC C1779 Blower Switch Failure</li> </ul>	<ul style="list-style-type: none"> <li>• Circuit(s).</li> <li>• Interface adapter assembly (IAA) module.</li> <li>• Blower switch.</li> </ul>	<ul style="list-style-type: none"> <li>• GO to <a href="#">Pinpoint Test F</a>.</li> </ul>

**DIAGNOSIS AND TESTING (Continued)****Symptom Chart (Continued)**

<b>Condition</b>	<b>Possible Sources</b>	<b>Action</b>
<ul style="list-style-type: none"> <li>DTC C1780 Temperature Select Failure</li> </ul>	<ul style="list-style-type: none"> <li>Circuit(s).</li> <li>Interface adapter assembly (IAA) module.</li> <li>Temperature control potentiometer.</li> </ul>	<ul style="list-style-type: none"> <li>GO to <a href="#">Pinpoint Test G.</a></li> </ul>
<ul style="list-style-type: none"> <li>DTC B1857 Climate Control On/Off Switch Failure</li> </ul>	<ul style="list-style-type: none"> <li>Interface adapter assembly (IAA) module.</li> <li>A/C inverter motor controller (IMC).</li> <li>Circuit(s).</li> <li>Mode select switch.</li> <li>Recirculation vacuum pressure sensor.</li> </ul>	<ul style="list-style-type: none"> <li>GO to <a href="#">Pinpoint Test H.</a></li> </ul>
<ul style="list-style-type: none"> <li>Blower (Fan) Runs With Mode Select Switch in OFF Position</li> </ul>	<ul style="list-style-type: none"> <li>Shorted Variable Blower Controller (VBC)</li> <li>Interface Adapter Assembly (IAA).</li> <li>Circuit(s).</li> <li>Recirculation vacuum pressure sensor.</li> </ul>	<ul style="list-style-type: none"> <li>GO to <a href="#">Pinpoint Test H.</a></li> </ul>
<ul style="list-style-type: none"> <li>DTC U2015 Signal Link Fault (Non SCP)</li> </ul>	<ul style="list-style-type: none"> <li>Positive temperature coefficient (PTC) module.</li> <li>Circuit(s).</li> <li>Interface adapter assembly (IAA) module.</li> <li>PTC heater core.</li> </ul>	<ul style="list-style-type: none"> <li>GO to <a href="#">Pinpoint Test J.</a></li> </ul>
<ul style="list-style-type: none"> <li>DTC B2513 Blower (Fan) Circuit Failure</li> </ul>	<ul style="list-style-type: none"> <li>Circuit(s).</li> <li>Variable blower controller (VBC).</li> <li>Blower motor relay.</li> <li>Blower motor.</li> <li>Interface adapter assembly (IAA) module.</li> </ul>	<ul style="list-style-type: none"> <li>GO to <a href="#">Pinpoint Test K.</a></li> </ul>
<ul style="list-style-type: none"> <li>DTC B2514 Blower (Fan) Circuit Short to Vbat</li> </ul>	<ul style="list-style-type: none"> <li>Blower motor relay.</li> <li>Circuit(s).</li> <li>Interface adapter assembly (IAA) module.</li> </ul>	<ul style="list-style-type: none"> <li>GO to <a href="#">Pinpoint Test L.</a></li> </ul>
<ul style="list-style-type: none"> <li>DTC B2515 Heater Blower Relay Circuit Failure</li> </ul>	<ul style="list-style-type: none"> <li>Variable blower controller (VBC).</li> <li>Circuit(s).</li> <li>Interface adapter assembly (IAA) module.</li> </ul>	<ul style="list-style-type: none"> <li>GO to <a href="#">Pinpoint Test M.</a></li> </ul>
<ul style="list-style-type: none"> <li>DTC B2516 Blower Control Circuit Failure</li> </ul>	<ul style="list-style-type: none"> <li>Circuit(s).</li> <li>Variable blower controller (VBC).</li> <li>Interface adapter assembly (IAA) module.</li> </ul>	<ul style="list-style-type: none"> <li>GO to <a href="#">Pinpoint Test N.</a></li> </ul>
<ul style="list-style-type: none"> <li>No Heat/Insufficient Heat</li> </ul>	<ul style="list-style-type: none"> <li>Interface adapter assembly (IAA) module.</li> <li>Circuit(s).</li> <li>Positive temperature coefficient (PTC) switching module.</li> </ul>	<ul style="list-style-type: none"> <li>GO to <a href="#">Pinpoint Test P.</a></li> </ul>

**DIAGNOSIS AND TESTING (Continued)**

**Symptom Chart (Continued)**

Condition	Possible Sources	Action
<ul style="list-style-type: none"> <li>Vacuum Pump Cycles On and Off Without Brake Pedal Activation (Climate Control Vacuum System Leak Test)/Incorrect Airflow Through Climate Control Outlets</li> </ul>	<ul style="list-style-type: none"> <li>Vacuum line(s)/connection(s).</li> <li>Climate control vacuum reservoir.</li> <li>Vacuum jumper harness.</li> <li>Heater plenum vacuum line assembly.</li> <li>Mode select switch.</li> <li>Vacuum line routing.</li> <li>Vacuum motor(s).</li> </ul>	<ul style="list-style-type: none"> <li>GO to <a href="#">Pinpoint Test Q.</a></li> </ul>
<ul style="list-style-type: none"> <li>Recirculation Function Does Not Operate</li> </ul>	<ul style="list-style-type: none"> <li>Fresh/recirculation door vacuum motor actuator/linkage.</li> <li>Vacuum line.</li> <li>Circuit(s).</li> <li>Interface adapter assembly (IAA) module.</li> <li>Fresh/recirculation door vacuum motor.</li> <li>Fresh/recirculation select switch.</li> </ul>	<ul style="list-style-type: none"> <li>GO to <a href="#">Pinpoint Test R.</a></li> </ul>
<ul style="list-style-type: none"> <li>Blower (Fan) Runs With Mode Select Switch in OFF Position</li> </ul>	<ul style="list-style-type: none"> <li>Incorrect climate control assembly installed.</li> </ul>	<ul style="list-style-type: none"> <li>REMOVE climate control assembly and INSTALL correct one.</li> </ul>
<ul style="list-style-type: none"> <li>Pre-Heat Function Does Not Operate (Postal Ranger EV only) with DTC C1776.</li> </ul>	<ul style="list-style-type: none"> <li>Positive temperature coefficient (PTC) heater core.</li> <li>Circuit(s).</li> <li>PTC switching module.</li> <li>Interface adapter assembly (IAA).</li> <li>HVPDB.</li> <li>High-Voltage PTC HTR fuse.</li> </ul>	<ul style="list-style-type: none"> <li>GO to <a href="#">Pinpoint Test E.</a></li> </ul>
<ul style="list-style-type: none"> <li>Pre-Heat Function Does Not Operate (Postal Ranger EV only) without DTC C1776.</li> </ul>	<ul style="list-style-type: none"> <li>Bulb prove out.</li> <li>Incorrect conditions.</li> </ul>	<ul style="list-style-type: none"> <li>GO to <a href="#">Pinpoint Test S.</a></li> </ul>

**Pinpoint Tests**

**Special Tool(s)**

104-Pin Breakout Box (BOB) 418-049 (014-00950) or equivalent
Dial Thermometer 023-R0007 or equivalent

(Continued)

**Special Tool(s)**

Vacuum Tester 014-R1054 or equivalent
High-Voltage Insulated Safety Gloves 100-F036 or equivalent
Face Shield 100-F035 or equivalent

**PINPOINT TEST A: DTC B1238 OVER TEMPERATURE FAULT**

TEST STEP	ACTION TO TAKE
<b>A1 CHECK POSITIVE TEMPERATURE COEFFICIENT (PTC) HEATER OVERTEMPERATURE SWITCH STATUS</b> <ul style="list-style-type: none"> <li>With key ON, monitor interface adapter assembly (IAA) module PID HTR_OT.</li> <li>Disconnect PTC switching module C1999.</li> <li><b>Does the HTR_OT PID indicate YES?</b></li> </ul>	Yes = GO to A7. No = GO to A2.
<b>A2 CHECK PTC HEATER OVERTEMPERATURE SWITCH</b>	

(Continued)

**DIAGNOSIS AND TESTING (Continued)****PINPOINT TEST A: DTC B1238 OVER TEMPERATURE FAULT**

<b>TEST STEP</b>	<b>ACTION TO TAKE</b>
<ul style="list-style-type: none"> <li>With key OFF, disconnect in-line C2999 and measure the resistance between the Y/W wire and GY/W wire on C2999M.</li> <li><b>Is the resistance less than 5 ohms?</b></li> </ul>	Yes = GO to <b>A3</b> . No = REPLACE the PTC heater overtemperature switch harness assembly.
<b>A3 CHECK GROUND REFERENCE TO PTC HEATER OVERTEMPERATURE SWITCH</b> <ul style="list-style-type: none"> <li>With key OFF, measure the resistance between the Y/W wire on C2999F and ground.</li> <li><b>Is the resistance less than 5 ohms?</b></li> </ul>	Yes = GO to <b>A5</b> . No = GO to <b>A4</b> .
<b>A4 CHECK CIRCUIT 3036 (Y/W) FOR OPEN</b> <ul style="list-style-type: none"> <li>Connect 104-Pin Breakout Box (BOB) to IAA module C1945; leave IAA module disconnected.</li> <li>With key OFF, measure the resistance of the Y/W wire between BOB pin 74 and C2999F.</li> <li><b>Is the resistance less than 5 ohms?</b></li> </ul>	Yes = REPLACE the IAA module. REFER to <a href="#">Section 412-04</a> . No = REPAIR the Y/W wire.
<b>A5 CHECK CIRCUIT 3037 (GY/W) FOR OPEN</b> <ul style="list-style-type: none"> <li>With key OFF, disconnect PTC switching module C1999 and measure the resistance of the GY/W wire between pin 3 on PTC switching module C1999 and C2999F.</li> <li><b>Is the resistance less than 5 ohms?</b></li> </ul>	Yes = GO to <b>A6</b> . No = REPAIR the GY/W wire.
<b>A6 CHECK CIRCUITS 3036 (Y/W) AND 3037 (GY/W) FOR SHORT(S) TO POWER</b> <ul style="list-style-type: none"> <li>With key OFF, disconnect IAA module C1945.</li> <li>With key ON, measure the voltage between pin 2 (Y/W wire), pin 3 (GY/W wire) on PTC switching module C1999 and ground.</li> <li><b>Are any of the voltages greater than 0 volts?</b></li> </ul>	Yes = REPAIR the wire(s) in question. No = REPLACE the PTC switching module.
<b>A7 CHECK CIRCUIT 3834 (LG) FOR SHORT TO GROUND</b> <ul style="list-style-type: none"> <li>With key OFF, disconnect IAA module C1945 and measure the resistance between pin 6 (LG wire) on PTC switching module C1999 and ground.</li> <li><b>Is the resistance greater than 10,000 ohms?</b></li> </ul>	Yes = REPLACE the IAA module. REFER to <a href="#">Section 412-04</a> . No = REPAIR the LG wire.

**PINPOINT TEST B: DTC B1249 BLEND DOOR FAILURE**

<b>TEST STEP</b>	<b>ACTION TO TAKE</b>
<b>B1 CHECK BLEND DOOR ACTUATOR FEEDBACK</b> <ul style="list-style-type: none"> <li>Enter interface adapter assembly (IAA) module active command mode CONTINUOUS BLEND DOOR MOVEMENT, monitor the IAA module PID BLENDDDR, and set the active command CONT to 10%, 50%, and 90%.</li> <li><b>Is the BLENDDDR PID within 3% of the active command settings?</b></li> </ul>	Yes = System OK. CHECK wiring for intermittent connections. No = GO to <b>B2</b> .
<b>B2 CHECK DRIVE VOLTAGE TO BLEND DOOR ACTUATOR MOTOR</b> <ul style="list-style-type: none"> <li>With key OFF, disconnect blend door actuator C240 and connect a voltmeter between pin 7 (BR/LG wire) and pin 8 (P wire) on blend door actuator C240.</li> <li>Enter the IAA module active command mode CONTINUOUS BLEND DOOR MOVEMENT and set the active command CONT to 90%.</li> <li><b>Does the voltage fluctuate between 0 and ±12 volts and then stabilize at greater than 9 volts?</b></li> </ul>	Yes = REPLACE the blend door actuator. No = GO to <b>B3</b> .

(Continued)

**DIAGNOSIS AND TESTING (Continued)****PINPOINT TEST B: DTC B1249 BLEND DOOR FAILURE**

TEST STEP	ACTION TO TAKE
<p><b>B3 CHECK CIRCUITS 245 (BR/LG), 246 (P), 436 (R/LG), 437 (Y/LG), AND 438 (R/W) FOR OPEN(S)</b></p> <ul style="list-style-type: none"> <li>• Connect 104-Pin Breakout Box (BOB) to IAA module C1945; leave the IAA module disconnected.</li> <li>• With key OFF, measure the resistance of the BR/LG wire between pin 7 on blend door actuator C240 and BOB pin 6.</li> <li>• With key OFF, measure the resistance of the P wire between pin 8 on blend door actuator C240 and BOB pin 7.</li> <li>• With key OFF, measure the resistance of the R/LG wire between pin 6 on blend door actuator C240 and BOB pin 85.</li> <li>• With key OFF, measure the resistance of the Y/LG wire between pin 1 on blend door actuator C240 and BOB pin 51.</li> <li>• With key OFF, measure the resistance of the R/W wire between pin 5 on blend door actuator C240 and BOB pin 72.</li> <li>• <b>Are the resistances less than 5 ohms?</b></li> </ul>	<p>Yes = GO to <b>B4</b>.</p> <p>No = REPAIR the wire(s) in question.</p>
<p><b>B4 CHECK CIRCUITS 245 (BR/LG), 246 (P), 436 (R/LG), AND 437 (Y/LG) FOR SHORT(S) TO GROUND</b></p> <ul style="list-style-type: none"> <li>• With key OFF, measure the resistance between BOB pins 6, 7, 51, 85 and ground (BOB pin 80).</li> <li>• <b>Are the resistances greater than 10,000 ohms?</b></li> </ul>	<p>Yes = GO to <b>B5</b>.</p> <p>No = REPAIR the wire(s) in question.</p>
<p><b>B5 CHECK RESISTANCE OF BLEND DOOR ACTUATOR</b></p> <ul style="list-style-type: none"> <li>• With key OFF, reconnect blend door actuator C240.</li> <li>• With key OFF, connect the IAA module to BOB; leave BOB connected to IAA module C1945.</li> </ul> <p><b>NOTE:</b> You must set the temperature control knob to the full warm position before disconnecting the IAA module from the BOB. Failure to do so will result in misdiagnosis of the blend door actuator.</p> <ul style="list-style-type: none"> <li>• With key ON, set the mode select knob to the PANEL/FLOOR position and the temperature control knob to the full warm position, and monitor the IAA module PID BLENDDDR until it indicates approximately 90%.</li> <li>• With key OFF, disconnect the IAA module from BOB; leave BOB connected to IAA module C1945.</li> <li>• With key OFF, measure the resistance between the indicated BOB pins and verify the resistances below: <ul style="list-style-type: none"> <li>—BOB pins 51 and 85 = 250-1,500 ohms</li> <li>—BOB pins 51 and 72 = 3,500-6,000 ohms</li> <li>—BOB pins 72 and 85 = 5,000-7,000 ohms</li> </ul> </li> <li>• <b>Are the resistances OK?</b></li> </ul>	<p>Yes = REPLACE the IAA module. REFER to <a href="#">Section 412-04</a>.</p> <p>No = REPLACE the blend door actuator.</p>

**PINPOINT TEST C: DTC B1250 AIR TEMPERATURE INTERNAL SENSOR CIRCUIT FAILURE**

TEST STEP	ACTION TO TAKE
<p><b>C1 CHECK IN-CAR TEMPERATURE SENSOR</b></p> <ul style="list-style-type: none"> <li>• Connect 104-Pin Breakout Box (BOB) to IAA module C1945; leave IAA module disconnected.</li> <li>• With key OFF, measure the resistance between BOB pins 49 and 79 and compare the reading to the values below:</li> </ul> <p><b>Actual Temperature (Approximate)</b></p> <ul style="list-style-type: none"> <li>—0 °C (32°F) = 91,000-100,700 ohms</li> </ul>	<p>Yes = REPLACE the IAA module. REFER to <a href="#">Section 412-04</a>.</p> <p>No = GO to <b>C2</b>.</p>

(Continued)

**DIAGNOSIS AND TESTING (Continued)****PINPOINT TEST C: DTC B1250 AIR TEMPERATURE INTERNAL SENSOR CIRCUIT FAILURE**

<b>TEST STEP</b>	<b>ACTION TO TAKE</b>
—5 °C (41°F) = 71,100-78,700 ohms —10 °C (50°F) = 56,000-62,000 ohms —15 °C (59°F) = 44,400-49,100 ohms —20 °C (68°F) = 35,500-39,200 ohms —25 °C (77°F) = 28,500-31,500 ohms —30 °C (86°F) = 23,000-25,500 ohms —35 °C (95°F) = 18,700-20,700 ohms —40 °C (104°F) = 15,300-16,900 ohms • <b>Is the resistance OK?</b>	
<b>C2 CHECK CIRCUITS 3050 (W/O) AND 3060 (GY/R) FOR OPEN(S)</b> <ul style="list-style-type: none"> <li>With key OFF, disconnect in-car temperature sensor C2997 and measure the resistance of the W/O wire between in-car temperature sensor C2997 and BOB pin 49.</li> <li>With key OFF, measure the resistance of the GY/R wire between in-car temperature sensor C2997 and BOB pin 79.</li> <li><b>Are the resistances less than 5 ohms?</b></li> </ul>	Yes = GO to C3.  No = REPAIR the wire(s) in question.
<b>C3 CHECK CIRCUIT 3050 (W/O) FOR SHORT TO GROUND</b> <ul style="list-style-type: none"> <li>With key OFF, measure the resistance between BOB pin 49 and ground (BOB pin 80).</li> <li><b>Is the resistance greater than 10,000 ohms?</b></li> </ul>	Yes = GO to C4.  No = REPAIR the W/O wire.
<b>C4 CHECK CIRCUIT 3050 (W/O) FOR SHORT TO POWER</b> <ul style="list-style-type: none"> <li>With key ON, measure the voltage between BOB pin 49 and ground (BOB pin 80).</li> <li><b>Is the voltage greater than 0 volts?</b></li> </ul>	Yes = REPAIR the W/O wire.  No = GO to C5.
<b>C5 CHECK ASPIRATOR INSTALLATION</b> <ul style="list-style-type: none"> <li>With key OFF, access the in-car temperature sensor behind the glove compartment.</li> <li>Check for proper installation of in-car temperature sensor hose and elbow.</li> <li><b>Is the aspirator installed correctly and the hose connected?</b></li> </ul>	Yes = REPLACE the in-car temperature sensor.  No = REPAIR as necessary.

**PINPOINT TEST D: DTC B1254 AIR TEMPERATURE EXTERNAL SENSOR CIRCUIT FAILURE**

<b>TEST STEP</b>	<b>ACTION TO TAKE</b>
<b>D1 CHECK AMBIENT TEMPERATURE SENSOR</b> <ul style="list-style-type: none"> <li>With key OFF, disconnect ambient temperature sensor C1952, measure the resistance between the terminals of the ambient temperature sensor and compare the reading to the values below:  <b>Actual Temperature (Approximate)</b>            —0 °C (32°F) = 91,000-100,700 ohms            —5 °C (41°F) = 71,100-78,700 ohms            —10 °C (50°F) = 56,000-62,000 ohms            —15 °C (59°F) = 44,400-49,100 ohms            —20 °C (68°F) = 35,500-39,200 ohms            —25 °C (77°F) = 28,500-31,500 ohms            —30 °C (86°F) = 23,000-25,500 ohms            —35 °C (95°F) = 18,700-20,700 ohms            —40 °C (104°F) = 15,300-16,900 ohms</li> <li><b>Is the resistance OK?</b></li> </ul>	Yes = GO to D2.  No = REPLACE the ambient temperature sensor.

(Continued)



**DIAGNOSIS AND TESTING (Continued)****PINPOINT TEST D: DTC B1254 AIR TEMPERATURE EXTERNAL SENSOR CIRCUIT FAILURE**

TEST STEP	ACTION TO TAKE
<b>D2 CHECK CIRCUITS 3061 (LB/O) AND 3062 (BK/W) FOR OPEN(S)</b> <ul style="list-style-type: none"> <li>Connect 104-Pin Breakout Box (BOB) to IAA module C1945; leave IAA module disconnected.</li> <li>With key OFF, measure the resistance of the LB/O wire between ambient temperature sensor C1952 and BOB pin 96.</li> <li>With key OFF, measure the resistance of the BK/W wire between in-car temperature sensor C1952 and BOB pin 77.</li> <li><b>Are the resistances less than 5 ohms?</b></li> </ul>	Yes = GO to <b>D3</b> . No = REPAIR the wire(s) in question.
<b>D3 CHECK CIRCUIT 3061 (LB/O) FOR SHORT TO GROUND</b> <ul style="list-style-type: none"> <li>With key OFF, measure the resistance between BOB pin 96 and ground (BOB pin 80).</li> <li><b>Is the resistance greater than 10,000 ohms?</b></li> </ul>	Yes = GO to <b>D4</b> . No = REPAIR the LB/O wire.
<b>D4 CHECK CIRCUIT 3061 (LB/O) FOR SHORT TO POWER</b> <ul style="list-style-type: none"> <li>With key ON, measure the voltage between BOB pin 77 and ground (BOB pin 80).</li> <li><b>Is the voltage greater than 0 volts?</b></li> </ul>	Yes = REPAIR the LB/O wire. No = REPLACE the IAA module. REFER to <a href="#">Section 412-04</a> .

**PINPOINT TEST E: DTC C1776 HEATER SYSTEM FAILURE**

TEST STEP	ACTION TO TAKE
<b>E1 RETRIEVE CONTINUOUS DIAGNOSTIC TROUBLE CODES (DTCs) FROM INTERFACE ADAPTER ASSEMBLY (IAA) MODULE WHILE IN PANEL/FLOOR MODE</b> <ul style="list-style-type: none"> <li>With key ON, set the mode select knob to the PANEL/FLOOR position and the temperature control knob to the full warm position.</li> <li>Wait approximately 45 seconds and retrieve continuous DTCs from the IAA module.</li> <li><b>Do any climate control DTCs occur along with DTC C1776 Heater System Failure?</b></li> </ul>	Yes = REFER to <a href="#">Symptom Chart</a> . No = GO to <b>E2</b> .
<b>E2 CHECK STATUS OF POSITIVE TEMPERATURE COEFFICIENT (PTC) HEATER CORES</b> <p><b>NOTE:</b> Turn the key to the OFF position and clear continuous IAA module DTCs before proceeding. If PIDs CORE__A and CORE__B indicate RETRY and PIDs HTR__CAR and HTR__CBR indicate YES after 45 seconds, wait approximately 4 minutes for the results. If CORE__A or CORE__B does not indicate FAULT, cycle the ignition key OFF/ON and repeat.</p> <ul style="list-style-type: none"> <li>With key ON, set the mode select knob to the PANEL/FLOOR position and the temperature control knob to the full warm position, and monitor IAA module PIDs CORE__A, CORE__B, HTR__CAR, and HTR__CBR for approximately 45 seconds.</li> <li><b>Do CORE__A and CORE__B PIDs both indicate FAULT?</b></li> </ul>	Yes = GO to <b>E11</b> . No = If only CORE__A PID indicates FAULT, GO to <b>E3</b> . If only CORE__B PID indicates FAULT, GO to <b>E7</b> .
<b>E3 CHECK PTC HEATER CORE A</b> <ul style="list-style-type: none"> <li>Disconnect the 12-volt auxiliary battery negative cable.</li> </ul>	Yes = GO to <b>E4</b> .

(Continued)

**DIAGNOSIS AND TESTING (Continued)****PINPOINT TEST E: DTC C1776 HEATER SYSTEM FAILURE**

TEST STEP	ACTION TO TAKE
<ul style="list-style-type: none"> <li>• Remove the high-voltage power distribution box (HVPDB) cover.</li> <li>• Disconnect PTC switching module high-voltage C1912 and measure the resistance between the DB wire and DG wire on PTC switching module C1912M.</li> <li>• <b>Is the resistance between 65 and 140 ohms?</b></li> </ul>	No = REPLACE the PTC heater core.
<b>E4 CHECK PTC HEATER CORE A CONTROL SIGNAL</b> <ul style="list-style-type: none"> <li>• With key OFF, reconnect PTC switching module C1912.</li> <li>• Reinstall HVPDB cover.</li> <li>• Connect 104-Pin Breakout Box (BOB) to IAA module and IAA module C1945.</li> <li>• Reconnect the 12-volt auxiliary battery negative cable.</li> <li>• With key ON, set the mode select knob to the PANEL/FLOOR position and the temperature control knob to the full warm position, and monitor IAA module PID CORE__A.</li> <li>• Cycle the ignition key (if necessary) OFF/ON until the CORE__A PID indicates ON.</li> <li>• Measure the voltage between BOB pin 33 and ground (BOB pin 80).</li> <li>• <b>Is the voltage greater than 2 volts?</b></li> </ul>	Yes = GO to <b>E17</b> . No = GO to <b>E5</b> .
<b>E5 CHECK PTC HEATER CORE A CONTROL CIRCUIT FOR SHORT TO GROUND</b> <ul style="list-style-type: none"> <li>• With key OFF, disconnect BOB from IAA module; leave BOB connected to IAA module C1945.</li> <li>• With key OFF, measure the resistance between BOB pin 33 and ground (BOB pin 80).</li> <li>• <b>Is the resistance less than 7,000 ohms?</b></li> </ul>	Yes = GO to <b>E6</b> . No = REPLACE the IAA module. REFER to <a href="#">Section 412-04</a> .
<b>E6 CHECK CIRCUIT 3260 (O/W) FOR SHORT TO GROUND</b> <ul style="list-style-type: none"> <li>• Reconnect the 12-volt auxiliary battery negative cable.</li> <li>• With key OFF, disconnect PTC switching module C1999 and measure the resistance between BOB pin 33 and ground (BOB pin 80).</li> <li>• <b>Is the resistance greater than 10,000 ohms?</b></li> </ul>	Yes = REPLACE the PTC switching module. REFER to <a href="#">Section 412-04</a> . No = REPAIR the O/W wire.
<b>E7 CHECK PTC HEATER CORE B</b> <ul style="list-style-type: none"> <li>• Disconnect the 12-volt auxiliary battery negative cable.</li> <li>• Remove the high-voltage power distribution box (HVPDB) cover.</li> <li>• Disconnect PTC switching module high-voltage C1912 and measure the resistance between the R wire and W wire on PTC switching module C1912M.</li> <li>• <b>Is the resistance between 65 and 140 ohms?</b></li> </ul>	Yes = GO to <b>E8</b> . No = REPLACE the PTC heater core.
<b>E8 CHECK PTC HEATER CORE B CONTROL SIGNAL</b> <ul style="list-style-type: none"> <li>• With key OFF, reconnect PTC switching module C1912.</li> <li>• Reinstall HVPDB cover.</li> <li>• Connect 104-Pin Breakout Box (BOB) to IAA module and IAA module C1945.</li> <li>• Reconnect the 12-volt auxiliary battery negative cable.</li> <li>• With key ON, set the mode select knob to the PANEL/FLOOR position and the temperature control knob to the full warm position, and monitor IAA module PID CORE__B.</li> <li>• Cycle the ignition key (if necessary) OFF/ON until the CORE__B PID indicates ON.</li> <li>• Measure the voltage between BOB pin 34 and ground (BOB pin 80).</li> <li>• <b>Is the voltage greater than 2 volts?</b></li> </ul>	Yes = GO to <b>E17</b> . No = GO to <b>E9</b> .

(Continued)

**DIAGNOSIS AND TESTING (Continued)****PINPOINT TEST E: DTC C1776 HEATER SYSTEM FAILURE**

<b>TEST STEP</b>	<b>ACTION TO TAKE</b>
<b>E9 CHECK PTC HEATER CORE B CONTROL CIRCUIT FOR SHORT TO GROUND</b> <ul style="list-style-type: none"> <li>• With key OFF, disconnect BOB from IAA module; leave BOB connected to IAA module C1945.</li> <li>• With key OFF, measure the resistance between BOB pin 34 and ground (BOB pin 80).</li> <li>• <b>Is the resistance less than 7,000 ohms?</b></li> </ul>	Yes = GO to <b>E10</b> . No = REPLACE the IAA module. REFER to <a href="#">Section 412-04</a> .
<b>E10 CHECK CIRCUIT 3261 (PK/Y) FOR SHORT TO GROUND</b> <ul style="list-style-type: none"> <li>• Reconnect the 12-volt auxiliary battery negative cable.</li> <li>• With key OFF, disconnect PTC switching module C1999 and measure the resistance between BOB pin 34 and ground (BOB pin 80).</li> <li>• <b>Is the resistance greater than 10,000 ohms?</b></li> </ul>	Yes = REPLACE the PTC switching module. REFER to <a href="#">Section 412-04</a> . No = REPAIR the PK/Y wire.
<b>E11 CHECK PTC HEATER CORES</b> <ul style="list-style-type: none"> <li>• Disconnect the 12-volt auxiliary battery negative cable.</li> <li>• Remove the high-voltage power distribution box (HVPDB) cover.</li> <li>• Disconnect PTC switching module high-voltage C1912 and measure the resistance between the DB wire and DG wire on PTC switching module C1912M.</li> <li>• Measure the resistance between the R wire and W wire on PTC switching module C1912M.</li> <li>• <b>Are the resistances between 65 and 140 ohms?</b></li> </ul>	Yes = GO to <b>E12</b> . No = REPLACE the PTC heater core.
<b>E12 CHECK HIGH-VOLTAGE POWER TO PTC SWITCHING MODULE</b> <p> <b>WARNING: The following test steps contain high-voltage procedures. High-voltage insulated safety gloves and face shield must be worn when carrying out the following steps. Failure to follow this warning may result in severe personal injury or death.</b></p> <ul style="list-style-type: none"> <li>• Disconnect HVPDB PTC switching module high-voltage C1920.</li> <li>• Reinstall the HVPDB cover.</li> <li>• Reconnect the 12-volt auxiliary battery negative cable.</li> <li>• With key ON, measure the voltage between circuit 3104 (DB wire) and circuit 3105 (W wire) on HVPDB PTC switching module C1920F.</li> <li>• <b>Is the voltage greater than 300 volts?</b></li> </ul>	Yes = GO to <b>E17</b> . No = GO to <b>E13</b> .
<b>E13 CHECK HIGH-VOLTAGE FUSE</b> <ul style="list-style-type: none"> <li>• With key OFF, disconnect the 12-volt auxiliary battery negative cable.</li> <li>• Disconnect high-voltage auxiliary load in-line C1935 on the traction battery support tray.</li> <li>• Disconnect all HVPDB high-voltage connectors.</li> <li>• Disconnect power steering assembly high-voltage C1895.</li> <li>• Measure the resistance of the 25A PTC HTR fuse.</li> <li>• <b>Is the resistance greater than 1,000 ohms?</b></li> </ul>	Yes = REPLACE the 25A PTC HTR fuse. GO to <b>E14</b> . No = REPLACE the HVPDB. REFER to <a href="#">Section 414-03A</a> or <a href="#">Section 414-03B</a> .
<b>E14 CHECK PTC SWITCHING MODULE FOR SHORT</b> <ul style="list-style-type: none"> <li>• Measure the resistance between circuit 3104 (DB wire) and circuit 3105 (W wire) on HVPDB PTC switching module C1920M.</li> <li>• <b>Is the resistance less than 30 ohms?</b></li> </ul>	Yes = REPLACE the PTC switching module. No = GO to <b>E15</b> .
<b>E15 CHECK HVPDB FOR SHORT</b> <ul style="list-style-type: none"> <li>• Measure the resistance between circuit 3104 (DB wire) and circuit 3105 (W wire) on HVPDB PTC switching module C1920F.</li> </ul>	Yes = GO to <b>E16</b> .

(Continued)

**DIAGNOSIS AND TESTING (Continued)****PINPOINT TEST E: DTC C1776 HEATER SYSTEM FAILURE**

<b>TEST STEP</b>	<b>ACTION TO TAKE</b>
<ul style="list-style-type: none"> <li>Is the resistance greater than 10,000 ohms?</li> </ul>	No = REPLACE the HVPDB. REFER to <a href="#">Section 414-03A</a> or <a href="#">Section 414-03B</a> .
<b>E16 CHECK SYSTEM</b> <ul style="list-style-type: none"> <li>With key OFF, reconnect all component connectors that were disconnected.</li> <li>With key ON, set the mode select knob to the PANEL/FLOOR position, the temperature control knob to the full warm position, and the blower control knob to the HIGH speed position.</li> <li>Does the 25A PTC HTR high-voltage fuse fail again?</li> </ul>	Yes = REPLACE the PTC switching module. REPLACE the 25A PTC HTR fuse. REFER to <a href="#">Section 414-03A</a> or <a href="#">Section 414-03B</a> . No = System OK.
<b>E17 INSPECT PTC HEATER CORES</b> <ul style="list-style-type: none"> <li>Remove the PTC heater core and check for contaminants (excessive moisture or debris) on the heater core.</li> <li>Is the heater core clear of contaminants?</li> </ul>	Yes = REPLACE the PTC switching module. No = REMOVE the contaminants. If necessary, REPLACE the PTC heater core.

**PINPOINT TEST F: DTC C1779 BLOWER SWITCH FAILURE**

<b>TEST STEP</b>	<b>ACTION TO TAKE</b>
<b>F1 CHECK BLOWER SWITCH STATUS</b> <ul style="list-style-type: none"> <li>With key ON, monitor the interface adapter assembly (IAA) module PID BLOWER while rotating the blower control knob through all the blower speed positions.</li> <li>Does the BLOWER PID agree with all the blower speed positions?</li> </ul>	Yes = System OK. CHECK wiring for intermittent connections. No = GO to F2.
<b>F2 CHECK BLOWER SWITCH INPUT VOLTAGE REFERENCES</b> <ul style="list-style-type: none"> <li>Connect 104-Pin Breakout Box (BOB) to IAA module and IAA module C1945.</li> <li>With key ON, measure the voltage between BOB pins 60, 61, 62 and ground (BOB pin 80).</li> <li>Do the voltages fluctuate between 0 and 2.8 volts?</li> </ul>	Yes = GO to F7. No = GO to F3.
<b>F3 CHECK GROUND TO BLOWER SWITCH</b> <ul style="list-style-type: none"> <li>With key OFF, disconnect blower switch C232 and measure the resistance between the BK wire on blower switch C232 and ground.</li> <li>Is the resistance less than 5 ohms?</li> </ul>	Yes = GO to F4. No = REPAIR the BK wire.
<b>F4 CHECK CIRCUITS 751 (DB/W), 752 (Y/R), AND 754 (LG/W) FOR OPEN(S)</b> <ul style="list-style-type: none"> <li>With key OFF, disconnect IAA module from BOB; leave BOB connected to IAA module C1945.</li> <li>With key OFF, measure the resistance of the DB/W wire between blower switch C232 and BOB pin 62.</li> <li>With key OFF, measure the resistance of the Y/R wire between blower switch C232 and BOB pin 61.</li> <li>With key OFF, measure the resistance of the LG/W wire between blower switch C232 and BOB pin 60.</li> <li>Are the resistances less than 5 ohms?</li> </ul>	Yes = GO to F5. No = REPAIR the wire(s) in question.
<b>F5 CHECK CIRCUITS 751 (DB/W), 752 (Y/R), AND 754 (LG/W) FOR SHORT(S) TO GROUND</b>	

(Continued)

**DIAGNOSIS AND TESTING (Continued)****PINPOINT TEST F: DTC C1779 BLOWER SWITCH FAILURE**

<b>TEST STEP</b>	<b>ACTION TO TAKE</b>
<ul style="list-style-type: none"> <li>With key OFF, measure the resistance between BOB pins 60, 61, 62 and ground (BOB pin 80).</li> <li><b>Are the resistances greater than 10,000 ohms?</b></li> </ul>	Yes = GO to <b>F6</b> . No = REPAIR the wire(s) in question.
<b>F6 CHECK CIRCUITS 751 (DB/W), 752 (Y/R), AND 754 (LG/W) FOR SHORT(S) TO POWER</b> <ul style="list-style-type: none"> <li>With key ON, measure the voltage between BOB pins 60, 61, 62 and ground (BOB pin 80).</li> <li><b>Are any of the voltages greater than 0 volts?</b></li> </ul>	Yes = REPAIR the wire(s) in question. No = REPLACE the IAA module. REFER to <a href="#">Section 412-04</a> .
<b>F7 CHECK BLOWER SWITCH</b> <ul style="list-style-type: none"> <li>With key OFF, disconnect blower switch C232 and check the continuity of the blower switch by measuring the resistance between the circuit 57 (BK wire) terminal and the indicated terminals on the blower switch. Compare the readings to the values below:  <b>Low Blower Position</b> <ul style="list-style-type: none"> <li>—Circuit 751 (DB/W wire) terminal = Open</li> <li>—Circuit 752 (Y/R wire) terminal = Open</li> <li>—Circuit 754 (LG/W wire) terminal = Open</li> </ul> <b>Medium Blower Position</b> <ul style="list-style-type: none"> <li>—Circuit 751 (DB/W wire) terminal = Closed</li> <li>—Circuit 752 (Y/R wire) terminal = Open</li> <li>—Circuit 754 (LG/W wire) terminal = Open</li> </ul> <b>Medium-High Blower Position</b> <ul style="list-style-type: none"> <li>—Circuit 751 (DB/W wire) terminal = Closed</li> <li>—Circuit 752 (Y/R wire) terminal = Closed</li> <li>—Circuit 754 (LG/W wire) terminal = Open</li> </ul> <b>High Blower Position</b> <ul style="list-style-type: none"> <li>—Circuit 751 (DB/W wire) terminal = Open</li> <li>—Circuit 752 (Y/R wire) terminal = Closed</li> <li>—Circuit 754 (LG/W wire) terminal = Closed</li> </ul> </li> <li><b>Is the blower switch OK?</b></li> </ul>	Yes = REPLACE the IAA module. REFER to <a href="#">Section 412-04</a> . No = REPLACE the blower switch.

**PINPOINT TEST G: DTC C1780 TEMPERATURE SELECT FAILURE**

<b>TEST STEP</b>	<b>ACTION TO TAKE</b>
<b>G1 CHECK TEMPERATURE CONTROL OPERATION</b> <ul style="list-style-type: none"> <li>With key ON, monitor the interface adapter assembly (IAA) module PID SET__TMP while rotating the temperature control knob from the full cool position to the full warm position.</li> <li><b>Does the SET__TMP PID indicate approximately 98% at the full cool position and approximately 1% at the full warm position?</b></li> </ul>	Yes = System OK. CHECK wiring for intermittent connections. No = GO to <b>G2</b> .
<b>G2 CHECK TEMPERATURE CONTROL VOLTAGE REFERENCE</b> <ul style="list-style-type: none"> <li>With key OFF, disconnect temperature control C231.</li> <li>With key ON, measure the voltage between the LG/O wire and Y/LG wire on temperature control C231.</li> <li><b>Is the voltage between 4.8 and 5.2 volts?</b></li> </ul>	Yes = GO to <b>G5</b> . No = GO to <b>G3</b> .
<b>G3 CHECK CIRCUITS 3057 (LG/O) AND 3059 (Y/LG) FOR OPEN(S)</b> <ul style="list-style-type: none"> <li>Connect 104-Pin Breakout Box (BOB) to IAA module C1945; leave IAA module disconnected.</li> </ul>	Yes = GO to <b>G4</b> .

(Continued)

**DIAGNOSIS AND TESTING (Continued)****PINPOINT TEST G: DTC C1780 TEMPERATURE SELECT FAILURE**

TEST STEP	ACTION TO TAKE
<ul style="list-style-type: none"> <li>With key OFF, measure the resistance of the LG/O wire between temperature control C231 and BOB pin 84.</li> <li>With key OFF, measure the resistance of the Y/LG wire between temperature control C231 and BOB pin 71.</li> <li><b>Are the resistances less than 5 ohms?</b></li> </ul>	No = REPAIR the wire(s) in question.
<b>G4 CHECK CIRCUIT 3057 (LG/O) FOR SHORT TO GROUND</b> <ul style="list-style-type: none"> <li>With key OFF, measure the resistance between BOB pin 84 and ground (BOB pin 80).</li> <li><b>Is the resistance greater than 10,000 ohms?</b></li> </ul>	Yes = REPLACE the IAA module. REFER to <a href="#">Section 412-04</a> . No = REPAIR the LG/O wire.
<b>G5 CHECK CIRCUIT 3058 (LG/R) FOR OPEN</b> <ul style="list-style-type: none"> <li>Connect 104-Pin Breakout Box (BOB) to IAA module C1945; leave IAA module disconnected.</li> <li>With key OFF, measure the resistance of the LG/R wire between pin 2 on temperature control C231 and BOB pin 50.</li> <li><b>Is the resistance less than 5 ohms?</b></li> </ul>	Yes = GO to <b>G6</b> . No = REPAIR the LG/R wire.
<b>G6 CHECK CIRCUIT 3058 (LG/R) FOR SHORT TO GROUND</b> <ul style="list-style-type: none"> <li>With key OFF, measure the resistance between BOB pin 50 and ground (BOB pin 80).</li> <li><b>Is the resistance greater than 10,000 ohms?</b></li> </ul>	Yes = GO to <b>G7</b> . No = REPAIR the LG/R wire.
<b>G7 CHECK CIRCUIT 3058 (LG/R) FOR SHORT TO POWER</b> <ul style="list-style-type: none"> <li>With key ON, measure the voltage between BOB pin 50 and ground (BOB pin 80).</li> <li><b>Is the voltage greater than 0 volts?</b></li> </ul>	Yes = REPAIR the LG/R wire. No = GO to <b>G8</b> .
<b>G8 CHECK RESISTANCE OF TEMPERATURE CONTROL POTENTIOMETER</b> <ul style="list-style-type: none"> <li>With key OFF, reconnect temperature control C231.</li> <li>With key OFF, measure the resistance between the BOB pins 50 and 84 with the temperature control knob in the indicated positions and verify the resistances below: <ul style="list-style-type: none"> <li>—Full cool = 90-300 ohms</li> <li>—Midscale = 2,000-3,000 ohms</li> <li>—Full warm = 4,000-5,000 ohms</li> </ul> </li> <li><b>Are the resistances OK?</b></li> </ul>	Yes = REPLACE the IAA module. REFER to <a href="#">Section 412-04</a> . No = REPLACE the temperature control potentiometer.

**PINPOINT TEST H: DTC B1857 CLIMATE CONTROL ON/OFF SWITCH FAILURE**

TEST STEP	ACTION TO TAKE
<b>H1 IDENTIFY VACUUM PUMP SYMPTOM</b> <ul style="list-style-type: none"> <li>With key ON, set the mode select knob to the OFF and PANEL/FLOOR positions and listen for the vacuum pump cycling on and off continuously.</li> <li><b>Does the vacuum pump cycle on and off continuously?</b></li> </ul>	Yes = GO to <a href="#">Pinpoint Test Q</a> . No = GO to <b>H2</b> .
<b>H2 IDENTIFY VEHICLE OPTION</b> <ul style="list-style-type: none"> <li>Identify the vehicle option (A/C or non-A/C).</li> <li><b>Is the vehicle equipped with A/C?</b></li> </ul>	Yes = GO to <b>H3</b> . No = GO to <b>H4</b> .
<b>H3 CARRY OUT ON-DEMAND SELF-TEST IN A/C MODE</b> <ul style="list-style-type: none"> <li>With key ON, set the mode select knob to the A/C position and carry out the on-demand self-test for the interface adapter assembly (IAA) module.</li> <li><b>Does DTC B1857 Climate Control On/Off Switch Failure occur?</b></li> </ul>	Yes = GO to <b>H5</b> . No = GO to <b>H4</b> .

(Continued)

**DIAGNOSIS AND TESTING (Continued)****PINPOINT TEST H: DTC B1857 CLIMATE CONTROL ON/OFF SWITCH FAILURE**

TEST STEP	ACTION TO TAKE
<b>H4 CARRY OUT ON-DEMAND SELF-TEST IN PANEL/FLOOR MODE</b> <ul style="list-style-type: none"> <li>With key ON, set the mode select knob to the PANEL/FLOOR position and carry out the on-demand self-test for the IAA module.</li> <li><b>Does DTC B1857 Climate Control On/Off Switch Failure occur?</b></li> </ul>	Yes = GO to <b>H11</b> . No = System OK. CHECK wiring for intermittent connections.
<b>H5 CHECK A/C PRESENT SIGNAL STATUS</b> <ul style="list-style-type: none"> <li>With key ON, monitor IAA module PID AC__PRST.</li> <li><b>Does the AC__PRST PID indicate YES?</b></li> </ul>	Yes = GO to <b>H8</b> . No = GO to <b>H6</b> .
<b>H6 CHECK A/C PRESENT SIGNAL FROM A/C INVERTER MOTOR CONTROLLER (IMC)</b> <ul style="list-style-type: none"> <li>Connect 104-Pin Breakout Box (BOB) to IAA module C1945; leave IAA module disconnected.</li> <li>With key OFF, measure the resistance between BOB pin 93 and ground (BOB pin 80).</li> <li><b>Is the resistance less than 5 ohms?</b></li> </ul>	Yes = REPLACE the IAA module. REFER to <a href="#">Section 412-04</a> . No = GO to <b>H7</b> .
<b>H7 CHECK CIRCUIT 3024 (DB/LG) FOR OPEN</b> <ul style="list-style-type: none"> <li>With key OFF, measure the resistance of the DB/LG wire between pin 3 on A/C IMC C1947 and BOB pin 93.</li> <li><b>Is the resistance less than 5 ohms?</b></li> </ul>	Yes = REPLACE the A/C IMC. REFER to <a href="#">Section 412-03</a> . No = REPAIR the DB/LG wire.
<b>H8 CHECK MODE SELECT SWITCH</b> <ul style="list-style-type: none"> <li>With key OFF, disconnect mode select switch C234.</li> <li>Measure the resistance between terminals 1 and 2 on the mode select switch with the mode select knob in the A/C and MAX A/C positions.</li> <li><b>Are the resistances less than 5 ohms?</b></li> </ul>	Yes = GO to <b>H9</b> . No = REPLACE the mode select switch.
<b>H9 CHECK GROUND TO MODE SELECT SWITCH</b> <ul style="list-style-type: none"> <li>With key OFF, measure the resistance between pin 1 (BK wire) on mode select switch C234 and ground.</li> <li><b>Is the resistance less than 5 ohms?</b></li> </ul>	Yes = GO to <b>H10</b> . No = REPAIR the BK wire.
<b>H10 CHECK CIRCUIT 3055 (BR/LG) FOR OPEN</b> <ul style="list-style-type: none"> <li>Connect 104-Pin Breakout Box (BOB) to interface adapter assembly (IAA) module C1945; leave IAA module disconnected.</li> <li>With key OFF, measure the resistance of the BR/LG wire between pin 2 on mode select switch C234 and BOB pin 59.</li> <li><b>Is the resistance less than 5 ohms?</b></li> </ul>	Yes = REPLACE the IAA module. REFER to <a href="#">Section 412-04</a> . No = REPAIR the BR/LG wire.
<b>H11 CHECK RECIRCULATION VACUUM PRESSURE SENSOR SIGNAL</b> <ul style="list-style-type: none"> <li>Connect 104-Pin Breakout Box (BOB) to the IAA module and IAA module C1945.</li> <li>With key ON, set the mode select knob to the OFF position and measure the voltage between BOB pin 94 and ground.</li> <li><b>Is the voltage between 0.25 and 3 volts?</b></li> </ul>	Yes = GO to <b>H18</b> . No = If voltage is less than 0.25 volts, GO to <b>H12</b> .  If voltage is greater than 3 volts, GO to <b>H16</b> .
<b>H12 CHECK RECIRCULATION VACUUM PRESSURE SENSOR VOLTAGE REFERENCE</b> <ul style="list-style-type: none"> <li>With key ON, measure the voltage between BOB pin 103 and ground (BOB pin 80).</li> <li><b>Is the voltage greater than 4.5 volts?</b></li> </ul>	Yes = GO to <b>H14</b> . No = GO to <b>H13</b> .
<b>H13 CHECK CIRCUIT 3066 (O/Y) FOR SHORT TO GROUND</b>	

(Continued)

**DIAGNOSIS AND TESTING (Continued)****PINPOINT TEST H: DTC B1857 CLIMATE CONTROL ON/OFF SWITCH FAILURE**

TEST STEP	ACTION TO TAKE
<ul style="list-style-type: none"> <li>• With key OFF, disconnect BOB from the IAA module; leave BOB connected to IAA module C1945.</li> <li>• With key OFF, disconnect recirculation vacuum pressure sensor C2993 and measure the resistance between BOB pin 103 and ground (BOB pin 80).</li> <li>• <b>Is the resistance greater than 10,000 ohms?</b></li> </ul>	Yes = REPLACE the IAA module. REFER to <a href="#">Section 412-04</a> . No = REPAIR the O/Y wire.
<b>H14 CHECK CIRCUITS 3066 (O/Y) AND 3067 (LB/R) FOR OPEN(S)</b> <ul style="list-style-type: none"> <li>• With key OFF, disconnect recirculation vacuum pressure sensor C2993 and measure the resistance of the O/Y wire between recirculation vacuum pressure sensor C2993 and BOB pin 103.</li> <li>• With key OFF, measure the resistance of the LB/R wire between recirculation vacuum pressure sensor C2993 and BOB pin 94.</li> <li>• <b>Are the resistances less than 5 ohms?</b></li> </ul>	Yes = GO to <b>H15</b> . No = REPAIR the wire(s) in question.
<b>H15 CHECK CIRCUIT 3067 (LB/R) FOR SHORT TO GROUND</b> <ul style="list-style-type: none"> <li>• With key OFF, disconnect BOB from the IAA module; leave BOB connected to IAA module C1945.</li> <li>• With key OFF, measure the resistance between BOB pin 94 and ground (BOB pin 80).</li> <li>• <b>Is the resistance greater than 10,000 ohms?</b></li> </ul>	Yes = REPLACE the recirculation vacuum pressure sensor. No = REPAIR the LB/R wire.
<b>H16 CHECK RECIRCULATION VACUUM PRESSURE SENSOR GROUND REFERENCE</b> <ul style="list-style-type: none"> <li>• With key OFF, measure the resistance between BOB pin 90 and ground (BOB pin 80).</li> <li>• <b>Is the resistance less than 5 ohms?</b></li> </ul>	Yes = GO to <b>H17</b> . No = REPLACE the IAA module. REFER to <a href="#">Section 412-04</a> .
<b>H17 CHECK CIRCUIT 3068 (BR/PK) FOR OPEN</b> <ul style="list-style-type: none"> <li>• With key OFF, disconnect BOB from the IAA module; leave BOB connected to IAA module C1945.</li> <li>• With key OFF, disconnect recirculation vacuum pressure sensor C2993 and measure the resistance of the BR/PK wire recirculation vacuum pressure sensor C2993 and BOB pin 90.</li> <li>• <b>Is the resistance less than 5 ohms?</b></li> </ul>	Yes = REPLACE the recirculation vacuum pressure sensor. No = REPAIR the BR/PK wire.
<b>H18 CHECK MODE SELECT SWITCH</b> <ul style="list-style-type: none"> <li>• With key OFF, disconnect mode select switch C234.</li> <li>• Measure the resistance between terminals 3 and 4 on the mode select switch with the mode select knob in the PANEL, PANEL/FLOOR, FLOOR, FLOOR/DEFROST, DEFROST, and A/C (if equipped) positions.</li> <li>• <b>Are the resistances less than 5 ohms?</b></li> </ul>	Yes = GO to <b>H19</b> . No = REPLACE the mode select switch.
<b>H19 CHECK GROUND TO MODE SELECT SWITCH</b> <ul style="list-style-type: none"> <li>• With key OFF, measure the resistance between pin 4 (BK wire) on mode select switch C234 and ground.</li> <li>• <b>Is the resistance less than 5 ohms?</b></li> </ul>	Yes = GO to <b>H20</b> . No = REPAIR the BK wire.
<b>H20 CHECK CIRCUIT 3056 (T/LG) FOR OPEN</b> <ul style="list-style-type: none"> <li>• With key OFF, measure the resistance of the T/LG wire between pin 3 on mode select switch C234 and BOB pin 58.</li> <li>• <b>Is the resistance less than 5 ohms?</b></li> </ul>	Yes = REPLACE the IAA module. REFER to <a href="#">Section 412-04</a> . No = REPAIR the T/LG wire.



**DIAGNOSIS AND TESTING (Continued)****PINPOINT TEST J: DTC U2015 SIGNAL LINK FAULT (NON SCP)**

TEST STEP	ACTION TO TAKE
<p><b>J1 CHECK HEATER CORE OVERTEMPERATURE STATUS</b></p> <p><b>NOTE:</b> Diagnostic trouble code (DTC) U2015 Signal Link Fault (Non SCP) occurs with other vehicle faults. Do NOT proceed with the following test steps unless the heating system is inoperative (no heat condition).</p> <ul style="list-style-type: none"> <li>• With key ON, monitor interface adapter assembly (IAA) module PID HTR__OT.</li> <li>• <b>Does the HTR__OT PID indicate YES?</b></li> </ul>	<p>Yes = GO to <a href="#">Pinpoint Test A.</a></p> <p>No = GO to <b>J2.</b></p>
<p><b>J2 CHECK SWITCHED POWER STATUS TO POSITIVE TEMPERATURE COEFFICIENT (PTC) SWITCHING MODULE</b></p> <p><b>NOTE:</b> The HTR__PWR PID may fluctuate between ENABLE and DISABLE when the key is turned to the ON position. If this occurs, you must wait 30 seconds for the final result.</p> <ul style="list-style-type: none"> <li>• With key ON, monitor IAA module PID HTR__PWR for 30 seconds.</li> <li>• <b>Does the HTR__PWR PID indicate ENABLE?</b></li> </ul>	<p>Yes = GO to <b>J7.</b></p> <p>No = GO to <b>J3.</b></p>
<p><b>J3 CHECK SWITCHED POWER TO PTC SWITCHING MODULE</b></p> <ul style="list-style-type: none"> <li>• With key OFF, disconnect PTC switching module C1999.</li> <li>• With key ON, measure the voltage between pin 1 (LG/O wire) and pin 2 (Y/W wire) on PTC switching module C1999.</li> <li>• <b>Is the voltage greater than 10 volts?</b></li> </ul>	<p>Yes = REPLACE the PTC switching module.</p> <p>No = GO to <b>J4.</b></p>
<p><b>J4 CHECK GROUND REFERENCE TO PTC SWITCHING MODULE</b></p> <ul style="list-style-type: none"> <li>• With key OFF, measure the resistance between pin 2 (Y/W wire) on PTC switching module C1999 and ground.</li> <li>• <b>Is the resistance less than 5 ohms?</b></li> </ul>	<p>Yes = GO to <b>J6.</b></p> <p>No = GO to <b>J5.</b></p>
<p><b>J5 CHECK CIRCUIT 3036 (Y/W) FOR OPEN</b></p> <ul style="list-style-type: none"> <li>• Connect 104-Pin Breakout Box (BOB) to IAA module C1945; leave IAA module disconnected.</li> <li>• With key OFF, measure the resistance of the Y/W wire between pin 2 on PTC switching module C1999 and BOB pin 74.</li> <li>• <b>Is the resistance less than 5 ohms?</b></li> </ul>	<p>Yes = REPLACE the IAA module. REFER to <a href="#">Section 412-04.</a></p> <p>No = REPAIR the Y/W wire.</p>
<p><b>J6 CHECK CIRCUIT 3035 (LG/O) FOR OPEN</b></p> <ul style="list-style-type: none"> <li>• Connect 104-Pin Breakout Box (BOB) to IAA module C1945; leave IAA module disconnected.</li> <li>• With key OFF, measure the resistance of the LG/O wire between pin 1 on PTC switching module C1999 and BOB pin 37.</li> <li>• <b>Is the resistance less than 5 ohms?</b></li> </ul>	<p>Yes = REPLACE the IAA module. REFER to <a href="#">Section 412-04.</a></p> <p>No = REPAIR the LG/O wire.</p>
<p><b>J7 CHECK STATUS OF PTC HEATER CORES</b></p> <p><b>NOTE:</b> Turn the key to the OFF position and clear continuous IAA module diagnostic trouble codes (DTCs) before proceeding. If PIDs CORE__A and CORE__B indicate RETRY and PIDs HTR__CAR and HTR__CBR indicate YES after 45 seconds, wait approximately 4 minutes for the results. If CORE__A or CORE__B does not indicate FAULT, cycle the ignition key OFF/ON and repeat.</p> <ul style="list-style-type: none"> <li>• With key ON, set the mode select knob to the PANEL/FLOOR position and the temperature control knob to the full warm position, and monitor IAA module PIDs CORE__A, CORE__B, HTR__CAR, HTR__CBR, and HTR__SHT for 45 seconds.</li> </ul> <p><b>NOTE:</b> If CORE__A and CORE__B PIDs both indicate OFF and the HTR__SHT PID indicates YES, GO to <b>J14.</b></p> <ul style="list-style-type: none"> <li>• <b>Does the CORE__A or the CORE__B PID indicate FAULT?</b></li> </ul>	<p>Yes = GO to <b>J8.</b></p> <p>No = GO to <b>J10.</b></p>

(Continued)

**DIAGNOSIS AND TESTING (Continued)****PINPOINT TEST J: DTC U2015 SIGNAL LINK FAULT (NON SCP)**

TEST STEP	ACTION TO TAKE
<b>J8 CHECK PTC HEATER CORES</b> <ul style="list-style-type: none"> <li>• Disconnect the 12-volt auxiliary battery negative cable.</li> <li>• Remove the high-voltage power distribution box (HVPDB) cover and disconnect PTC switching module high-voltage C1912 .</li> <li>• If CORE__A PID indicated FAULT, measure the resistance between the DB wire and DG wire on PTC switching module C1912M.</li> <li>• If CORE__B PID indicated FAULT, measure the resistance between the R wire and W wire on PTC switching module C1912M.</li> <li>• <b>Is the resistance between 65 and 140 ohms?</b></li> </ul>	Yes = GO to <b>J9</b> . No = REPLACE the PTC heater core.
<ul style="list-style-type: none"> <li>• Remove the PTC heater core and check for contaminants (excessive moisture and/or debris) on the heater core.</li> <li>• <b>Is the heater core clear of contaminants?</b></li> </ul>	<b>J9 INSPECT PTC HEATER CORES</b> Yes = REPLACE the PTC switching module. No = REMOVE the contaminants. If necessary, REPLACE the PTC heater core.
<b>J10 CHECK STATUS OF PTC POWER ON SELF-TEST (POST) LINE TO PTC SWITCHING MODULE</b> <ul style="list-style-type: none"> <li>• With key OFF, disconnect PTC switching module C1999.</li> <li>• With key ON, measure the voltage between pin 6 (LG wire) on PTC switching module C1999 and ground.</li> <li>• <b>Is the voltage greater than 9.5 volts?</b></li> </ul>	Yes = GO to <b>J12</b> . No = GO to <b>J11</b> .
<b>J11 CHECK CIRCUIT 3834 (LG) FOR OPEN</b> <ul style="list-style-type: none"> <li>• Connect 104-Pin Breakout Box (BOB) to interface adapter assembly (IAA) module C1945; leave IAA module disconnected.</li> <li>• With key OFF, measure the resistance of the LG wire between pin 6 on PTC switching module C1999 and BOB pin 65.</li> <li>• <b>Is the resistance less than 5 ohms?</b></li> </ul>	Yes = REPLACE the IAA module. REFER to <a href="#">Section 412-04</a> . No = REPAIR the LG wire.
<b>J12 CHECK CIRCUIT 3834 (LG) FOR SHORT TO POWER</b> <ul style="list-style-type: none"> <li>• Connect 104-Pin Breakout Box (BOB) to IAA module C1945; leave IAA module disconnected.</li> <li>• With key ON, measure the voltage between BOB pin 65 and ground (BOB pin 80).</li> <li>• <b>Is the voltage greater than 0 volts?</b></li> </ul>	Yes = REPAIR the LG wire. No = GO to <b>J13</b> .
<b>J13 CHECK STATUS OF PTC POST LINE TO IAA MODULE</b> <ul style="list-style-type: none"> <li>• With key OFF, reconnect PTC switching module C1999.</li> <li>• With key ON, measure the voltage between BOB pin 65 and ground (BOB pin 80).</li> <li>• <b>Is the voltage greater than 10 volts?</b></li> </ul>	Yes = System OK. CHECK wiring for intermittent connections. No = REPLACE the PTC switching module.
<b>J14 CHECK PTC SWITCHING MODULE FOR SHORT</b> <ul style="list-style-type: none"> <li>• With key ON, monitor IAA module PID HTR__SHT.</li> <li>• Disconnect PTC switching module C1999.</li> <li>• <b>Does the HTR__SHT PID indicate YES?</b></li> </ul>	Yes = GO to <b>J15</b> . No = REPLACE the PTC switching module.
<b>J15 CHECK CIRCUIT 3038 (O) FOR SHORT TO GROUND</b> <ul style="list-style-type: none"> <li>• Connect 104-Pin Breakout Box (BOB) to IAA module C1945; leave IAA module disconnected.</li> <li>• With key OFF, measure the resistance between BOB pin 53 and ground (BOB pin 80).</li> <li>• <b>Is the resistance greater than 10,000 ohms?</b></li> </ul>	Yes = REPLACE the IAA module. REFER to <a href="#">Section 412-04</a> . No = REPAIR the O wire.

**DIAGNOSIS AND TESTING (Continued)****PINPOINT TEST K: DTC B2513 BLOWER (FAN) CIRCUIT FAILURE**

TEST STEP	ACTION TO TAKE
<p><b>K1 RETRIEVE CONTINUOUS DIAGNOSTIC TROUBLE CODES (DTCs) FROM INTERFACE ADAPTER ASSEMBLY (IAA) MODULE WHILE IN PANEL/FLOOR MODE</b></p> <ul style="list-style-type: none"> <li>With key ON, set the mode select knob to the PANEL/FLOOR position and the temperature control knob to the full warm position.</li> <li>Wait approximately 45 seconds and retrieve continuous DTCs from the IAA module.</li> <li><b>Do DTC B2516 Blower Control Circuit Failure and DTC C1776 Heater System Failure occur?</b></li> </ul>	<p>Yes = GO to <a href="#">Pinpoint Test N</a>.</p> <p>No = GO to <b>K2</b>.</p>
<p><b>K2 CHECK BLOWER/FAN STATUS</b></p> <ul style="list-style-type: none"> <li>With key ON, set the mode select knob to the PANEL/FLOOR position and monitor the IAA module PIDs BLOWER and BFSV while rotating the blower control knob through all the blower speed positions and verify the voltages below: <ul style="list-style-type: none"> <li>—LOW = 9.8-10.4 volts</li> <li>—MED __1 = 6.8-7.4 volts</li> <li>—MED __2 = 3.9-4.5 volts</li> <li>—HIGH = 1.4-2.1 volts</li> </ul> </li> <li><b>Are the voltages correct?</b></li> </ul>	<p>Yes = System OK. CHECK wiring for intermittent connections.</p> <p>No = GO to <b>K3</b>.</p>
<p><b>K3 CHECK FUSE AND POWER TO BLOWER MOTOR RELAY</b></p> <ul style="list-style-type: none"> <li>Check 40A fuse 21 in the electric vehicle power distribution box (EVPDB).</li> <li>With key OFF, remove the blower motor relay from the EVPDB and measure the voltage between pins 85, 87 on the blower motor relay connector and ground. (V &gt; 10 volts)</li> <li><b>Is everything OK?</b></li> </ul>	<p>Yes = RECONNECT the blower motor relay. GO to <b>K4</b>.</p> <p>No = REPAIR as necessary.</p>
<p><b>K4 CHECK BLOWER MOTOR</b></p> <ul style="list-style-type: none"> <li>With key OFF, disconnect VBC C1971.</li> <li>With key ON, set the mode select knob to the PANEL/FLOOR position and connect a jumper wire between pin 4 (P/W wire) on VBC C1971 and ground.</li> <li><b>Does the blower motor operate?</b></li> </ul>	<p>Yes = GO to <b>K5</b>.</p> <p>No = GO to <b>K8</b>.</p>
<p><b>K5 CHECK VBC FEEDBACK SIGNAL</b></p> <ul style="list-style-type: none"> <li>With key OFF, reconnect VBC C1971.</li> <li>Connect 104-Pin Breakout Box (BOB) to IAA module and IAA module C1945.</li> </ul> <p><b>NOTE:</b> The mode select knob must be in the OFF position when carrying out this test step.</p> <ul style="list-style-type: none"> <li>With key ON, set the mode select knob to the OFF position and measure the voltage between BOB pin 64 and ground (BOB pin 80).</li> <li><b>Is the voltage greater than 10 volts?</b></li> </ul>	<p>Yes = REPLACE the IAA module. REFER to <a href="#">Section 412-04</a>.</p> <p>No = GO to <b>K6</b>.</p>
<p><b>K6 CHECK CIRCUIT 148 (Y/R) FOR OPEN</b></p> <ul style="list-style-type: none"> <li>With key OFF, disconnect BOB from the IAA module; leave BOB connected to IAA module C1945.</li> <li>With key OFF, disconnect VBC C1971 and measure the resistance of the Y/R wire between pin 1 on VBC C1971 and BOB pin 64.</li> <li><b>Is the resistance less than 5 ohms?</b></li> </ul>	<p>Yes = GO to <b>K7</b>.</p> <p>No = REPAIR the Y/R wire.</p>
<p><b>K7 CHECK CIRCUIT 148 (Y/R) FOR SHORT TO GROUND</b></p> <ul style="list-style-type: none"> <li>With key OFF, measure the resistance between BOB pin 64 and ground (BOB pin 80).</li> </ul>	<p>Yes = REPLACE the VBC. REFER to <a href="#">Section 412-04</a>.</p>

(Continued)

**DIAGNOSIS AND TESTING (Continued)****PINPOINT TEST K: DTC B2513 BLOWER (FAN) CIRCUIT FAILURE**

TEST STEP	ACTION TO TAKE
<ul style="list-style-type: none"> <li>Is the resistance greater than 10,000 ohms?</li> </ul>	No = REPAIR the Y/R wire.
<b>K8 CHECK POWER TO BLOWER MOTOR</b> <ul style="list-style-type: none"> <li>With key OFF, disconnect blower motor C161.</li> <li>With key ON, set the mode select knob to the PANEL/FLOOR position and measure the voltage between the BR/O wire on blower motor C161 and ground.</li> <li>Is the voltage greater than 10 volts?</li> </ul>	Yes = GO to <b>K9</b> . No = GO to <b>K10</b> .
<b>K9 CHECK CIRCUIT 758 (P/W) FOR OPEN</b> <ul style="list-style-type: none"> <li>With key OFF, measure the resistance of the P/W wire between blower motor C161 and pin 4 on VBC C1971.</li> <li>Is the resistance less than 5 ohms?</li> </ul>	Yes = REPLACE the blower motor. No = REPAIR the P/W wire.
<b>K10 CHECK CIRCUIT 181 (BR/O) FOR OPEN</b> <ul style="list-style-type: none"> <li>With key OFF, remove the blower motor relay from the EVPDB and measure the resistance of the BR/O wire between blower motor C161 and pin 30 on the blower motor relay connector.</li> <li>Is the resistance less than 5 ohms?</li> </ul>	Yes = GO to <b>K11</b> . No = REPAIR the BR/O wire.
<b>K11 CHECK BLOWER MOTOR RELAY CONTROL CIRCUIT</b> <ul style="list-style-type: none"> <li>Enter the IAA module active command mode CLIMATE SYSTEM CONTROL, set the active command PUMP/VBC to ON, and measure the resistance between pin 86 on the blower motor relay connector and ground.</li> <li>Is the resistance less than 5 ohms?</li> </ul>	Yes = REPLACE the blower motor relay. No = GO to <b>K12</b> .
<b>K12 CHECK CIRCUIT 3020 (LB) FOR OPEN</b> <ul style="list-style-type: none"> <li>Connect 104-Pin Breakout Box (BOB) to IAA module C1945; leave IAA module disconnected.</li> <li>With key OFF, measure the resistance of the LB wire between pin 86 on the blower motor relay connector and BOB pin 19.</li> <li>Is the resistance less than 5 ohms?</li> </ul>	Yes = REPLACE the IAA module. REFER to <a href="#">Section 412-04</a> . No = REPAIR the LB wire.

**PINPOINT TEST L: DTC B2514 BLOWER (FAN) CIRCUIT SHORT TO VBAT**

TEST STEP	ACTION TO TAKE
<b>L1 CHECK FOR BLOWER/FAN SYSTEM DIAGNOSTIC TROUBLE CODES (DTCs)</b> <ul style="list-style-type: none"> <li>Carry out the on-demand self-test for the interface adapter assembly (IAA) module and check for blower/fan system DTCs.</li> <li>Do DTC B2515 Heater Blower Relay Circuit Failure and DTC B2516 Blower Control Circuit Failure also occur?</li> </ul>	Yes = GO to <a href="#">Pinpoint Test N</a> . No = GO to <b>L2</b> .
<b>L2 CHECK BLOWER/FAN SENSE VOLTAGE</b> <ul style="list-style-type: none"> <li>Enter IAA module active command mode CLIMATE SYSTEM CONTROL, monitor the IAA module PID BFSV, and set the active command PUMP/VBC to OFF.</li> <li>Is the BFSV PID greater than 10 volts?</li> </ul>	Yes = GO to <b>L3</b> . No = System OK. CHECK wiring for intermittent connections.
<b>L3 CHECK BLOWER MOTOR RELAY</b> <ul style="list-style-type: none"> <li>With key OFF, remove the blower motor relay from the electric vehicle power distribution box (EVPDB) and measure the resistance between terminals 30 and 87 on the blower motor relay.</li> <li>Is the resistance less than 5 ohms?</li> </ul>	Yes = REPLACE the blower motor relay. No = GO to <b>L4</b> .
<b>L4 CHECK CIRCUIT 181 (BR/O) FOR SHORT TO POWER</b> <ul style="list-style-type: none"> <li>With key OFF, disconnect blower motor C161.</li> </ul>	Yes = REPAIR the BR/O wire.

(Continued)

**DIAGNOSIS AND TESTING (Continued)****PINPOINT TEST L: DTC B2514 BLOWER (FAN) CIRCUIT SHORT TO VBAT**

TEST STEP	ACTION TO TAKE
<ul style="list-style-type: none"> <li>With key ON, measure the voltage between pin 30 on the blower motor relay connector and ground.</li> <li><b>Is the voltage greater than 0 volts?</b></li> </ul>	No = GO to <b>L5</b> .
<b>L5 CHECK BLOWER MOTOR RELAY CONTROL CIRCUIT</b> <ul style="list-style-type: none"> <li>Enter the IAA module active command mode CLIMATE SYSTEM CONTROL, set the active command PUMP/VBC to OFF, and measure the resistance between pin 86 on the blower motor relay connector and ground.</li> <li><b>Is the resistance less than 5 ohms?</b></li> </ul>	Yes = GO to <b>L6</b> .  No = System OK. CHECK wiring for intermittent connections.
<b>L6 CHECK CIRCUIT 3020 (LB) FOR SHORT TO GROUND</b> <ul style="list-style-type: none"> <li>Connect 104-Pin Breakout Box (BOB) to IAA module C1945; leave IAA module disconnected.</li> <li>With key OFF, measure the resistance between BOB pin 19 and ground (BOB pin 80).</li> <li><b>Is the resistance greater than 10,000 ohms?</b></li> </ul>	Yes = REPLACE the IAA module. REFER to <a href="#">Section 412-04</a> . No = REPAIR the LB wire.

**PINPOINT TEST M: DTC B2515 HEATER BLOWER RELAY CIRCUIT FAILURE**

TEST STEP	ACTION TO TAKE
<b>M1 CHECK FOR BLOWER/FAN SYSTEM DIAGNOSTIC TROUBLE CODES (DTCs)</b> <ul style="list-style-type: none"> <li>Carry out the on-demand self-test for the interface adapter assembly (IAA) module and check for blower/fan system DTCs.</li> <li><b>Do DTC B2514 Blower (Fan) Circuit Short to Vbat and/or DTC B2516 Blower Control Circuit Failure also occur?</b></li> </ul>	Yes = GO to <a href="#">Pinpoint Test N</a> . No = GO to <b>M2</b> .
<b>M2 CHECK POWER TO VARIABLE BLOWER CONTROLLER (VBC)</b> <ul style="list-style-type: none"> <li>With key OFF, disconnect VBC C1971.</li> <li>With key ON, measure the voltage between pin 3 (R wire) on VBC C1971 and ground.</li> <li><b>Is the voltage greater than 10 volts?</b></li> </ul>	Yes = REPLACE the VBC. REFER to <a href="#">Section 412-04</a> . No = GO to <b>M3</b> .
<b>M3 CHECK CIRCUIT 361 (R) FOR OPEN</b> <ul style="list-style-type: none"> <li>Connect 104-Pin Breakout Box (BOB) to IAA module C1945; leave IAA module disconnected.</li> <li>With key OFF, measure the resistance of the R wire between pin 3 on VBC C1971 and BOB pin 38.</li> <li><b>Is the resistance less than 5 ohms?</b></li> </ul>	Yes = GO to <b>M4</b> . No = REPAIR the R wire.
<b>M4 CHECK CIRCUIT 361 (R) FOR SHORT TO POWER</b> <ul style="list-style-type: none"> <li>With key ON, measure the voltage between BOB pin 38 and ground (BOB pin 80).</li> <li><b>Is the voltage greater than 0 volts?</b></li> </ul>	Yes = REPAIR the R wire. No = REPLACE the IAA module. REFER to <a href="#">Section 412-04</a> .

**PINPOINT TEST N: DTC B2516 BLOWER CONTROL CIRCUIT FAILURE**

TEST STEP	ACTION TO TAKE
<b>N1 CHECK FOR BLOWER/FAN SYSTEM DIAGNOSTIC TROUBLE CODES (DTCs)</b> <ul style="list-style-type: none"> <li>Carry out the on-demand self-test for the interface adapter assembly (IAA) module and check for blower/fan system DTCs.</li> </ul>	Yes = If only DTC B2515, GO to <b>N2</b> .

(Continued)

**DIAGNOSIS AND TESTING (Continued)****PINPOINT TEST N: DTC B2516 BLOWER CONTROL CIRCUIT FAILURE**

TEST STEP	ACTION TO TAKE
<ul style="list-style-type: none"> <li>Do DTC B2514 Blower (Fan) Circuit Short to Vbat and/or DTC B2515 Heater Blower Relay Circuit Failure also occur?</li> </ul>	No = If both DTC B2514 and DTC B2515, GO to N3. GO to N5.
<b>N2 CHECK GROUND TO VARIABLE BLOWER CONTROLLER (VBC)</b> <ul style="list-style-type: none"> <li>With key OFF, disconnect VBC C1971 and measure the resistance between pin 5 (BK wire) on VBC C1971 and ground.</li> <li>Is the resistance less than 5 ohms?</li> </ul>	Yes = REPLACE the VBC. REFER to <a href="#">Section 412-04</a> . No = REPAIR the BK wire.
<b>N3 CHECK VARIABLE BLOWER CONTROLLER (VBC) FEEDBACK CIRCUIT FOR SHORT TO POWER</b> <ul style="list-style-type: none"> <li>With key OFF, disconnect VBC C1971.</li> <li>With key ON, measure the voltage between pin 1 (Y/R wire) on VBC C1971 and ground.</li> <li>Is the voltage greater than 0 volts?</li> </ul>	Yes = GO to N4. No = System OK. CHECK wiring for intermittent connections.
<b>N4 CHECK CIRCUIT 148 (Y/R) FOR SHORT TO POWER</b> <ul style="list-style-type: none"> <li>Connect 104-Pin Breakout Box (BOB) to IAA module C1945; leave IAA module disconnected.</li> <li>With key ON, measure the voltage between BOB pin 64 and ground (BOB pin 80).</li> <li>Is the voltage greater than 0 volts?</li> </ul>	Yes = REPAIR the Y/R wire. No = REPLACE the IAA module. REFER to <a href="#">Section 412-04</a> .
<b>N5 CHECK BLOWER/FAN STATUS</b> <ul style="list-style-type: none"> <li>With key ON, set the mode select knob to the PANEL/FLOOR position and monitor the IAA module PIDs BLOWER and BFSV while rotating the blower control knob through all the blower speed positions and verify the voltages below:               <ul style="list-style-type: none"> <li>—LOW = 9.8-10.4 volts</li> <li>—MED __1 = 6.8-7.4 volts</li> <li>—MED __2 = 3.9-4.5 volts</li> <li>—HIGH = 1.4-2.1 volts</li> </ul> </li> <li>Are the voltages correct?</li> </ul>	Yes = System OK. CHECK wiring for intermittent connections.  No = GO to N6.
<b>N6 CHECK CIRCUIT 515 (O/R) FOR OPEN</b> <ul style="list-style-type: none"> <li>Connect 104-Pin Breakout Box (BOB) to interface adapter assembly (IAA) module C1945; leave IAA module disconnected.</li> <li>With key OFF, disconnect variable blower controller (VBC) C1971 and measure the resistance of the O/R wire between pin 2 on VBC C1971 and BOB pin 5.</li> <li>Is the resistance less than 5 ohms?</li> </ul>	Yes = GO to N7. No = REPAIR the O/R wire.
<b>N7 CHECK CIRCUIT 515 (O/R) FOR SHORT TO GROUND</b> <ul style="list-style-type: none"> <li>With key OFF, measure the resistance between BOB pin 5 and ground (BOB pin 80).</li> <li>Is the resistance greater than 10,000 ohms?</li> </ul>	Yes = GO to N8. No = REPAIR the O/R wire.
<b>N8 CHECK CIRCUIT 515 (O/R) FOR SHORT TO POWER</b> <ul style="list-style-type: none"> <li>With key ON, measure the voltage between BOB pin 5 and ground (BOB pin 80).</li> <li>Is the voltage greater than 0 volts?</li> </ul>	Yes = REPAIR the O/R wire. No = REPLACE the VBC. REFER to <a href="#">Section 412-04</a> .

**DIAGNOSIS AND TESTING (Continued)****PINPOINT TEST P: NO HEAT/INSUFFICIENT HEAT**

TEST STEP	ACTION TO TAKE
<p><b>P1 CHECK POSITIVE TEMPERATURE COEFFICIENT (PTC) HEATER CORE CONTROL SIGNALS</b></p> <ul style="list-style-type: none"> <li>Connect 104-Pin Breakout Box (BOB) to interface adapter assembly (IAA) module and IAA module C1945.</li> <li>With key ON, set the mode select knob to the PANEL/FLOOR position and the temperature control knob to the full warm position, and monitor IAA module PIDs CORE__A and CORE__B.</li> <li>Note which PID indicates ON.</li> <li>If CORE__A PID indicates ON, measure the voltage between BOB pin 33 and ground (BOB pin 80).</li> <li>If CORE__B PID indicates ON, measure the voltage between BOB pin 34 and ground (BOB pin 80).</li> <li><b>Is the voltage between 2 and 3 volts?</b></li> </ul>	<p>Yes = GO to <b>P3</b>.</p> <p>No = If voltage equals 0 volts, REPLACE the IAA module. REFER to <a href="#">Section 412-04</a>.</p> <p>If voltage is greater than 4.5 volts, GO to <b>P2</b>.</p>
<p><b>P2 CHECK CIRCUIT 3260 (O/W) FOR OPEN</b></p> <ul style="list-style-type: none"> <li>With key OFF, disconnect PTC switching module C1999 and measure the resistance of the O/W wire between pin 4 on PTC switching module C1999 and BOB pin 33.</li> <li><b>Is the resistance less than 5 ohms?</b></li> </ul>	<p>Yes = REPLACE the PTC switching module.</p> <p>No = REPAIR the O/W wire.</p>
<p><b>P3 CHECK PTC HEATER CORE CONTROL SIGNALS AFTER CYCLING IGNITION KEY</b></p> <ul style="list-style-type: none"> <li>Turn the ignition key to the OFF position and then to the ON position.</li> <li>With key ON, set the mode select knob to the PANEL/FLOOR position and the temperature control knob to the full warm position, and monitor IAA module PIDs CORE__A and CORE__B.</li> <li>Note which PID indicates ON.</li> <li>If CORE__A PID indicates ON, measure the voltage between BOB pin 33 and ground (BOB pin 80).</li> <li>If CORE__B PID indicates ON, measure the voltage between BOB pin 34 and ground (BOB pin 80).</li> <li><b>Is the voltage between 2 and 3 volts?</b></li> </ul>	<p>Yes = System OK. CHECK wiring for intermittent connections.</p> <p>No = If voltage equals 0 volts, REPLACE the IAA module. REFER to <a href="#">Section 412-04</a>.</p> <p>If voltage is greater than 4.5 volts, GO to <b>P4</b>.</p>
<p><b>P4 CHECK CIRCUIT 3261 (PK/Y) FOR OPEN</b></p> <ul style="list-style-type: none"> <li>With key OFF, disconnect PTC switching module C1999 and measure the resistance of the PK/Y wire between pin 5 on PTC switching module C1999 and BOB pin 34.</li> <li><b>Is the resistance less than 5 ohms?</b></li> </ul>	<p>Yes = REPLACE the PTC switching module.</p> <p>No = REPAIR the PK/Y wire.</p>

**PINPOINT TEST Q: VACUUM PUMP CYCLES ON AND OFF WITHOUT BRAKE PEDAL ACTIVATION (CLIMATE CONTROL VACUUM SYSTEM LEAK TEST)/INCORRECT AIRFLOW THROUGH CLIMATE CONTROL OUTLETS**

TEST STEP	ACTION TO TAKE
<p><b>Q1 CHECK SYSTEM AIRFLOW</b></p> <ul style="list-style-type: none"> <li>With key ON, set the blower control knob to the HIGH position and rotate the mode select knob through all mode positions.</li> <li>Check the airflow through the climate control outlets for all mode positions.</li> <li><b>Does air flow through the correct outlets for all mode positions?</b></li> </ul>	<p>Yes = System OK. If vacuum pump cycles on and off continuously without brake pedal activation, GO to <b>Q4</b>.</p> <p>No = If air flows through defroster outlets for all mode positions, GO to <b>Q2</b>.</p> <p>If air flows through incorrect outlets, GO to <b>Q10</b>.</p>

(Continued)

**DIAGNOSIS AND TESTING (Continued)****PINPOINT TEST Q: VACUUM PUMP CYCLES ON AND OFF WITHOUT BRAKE PEDAL ACTIVATION (CLIMATE CONTROL VACUUM SYSTEM LEAK TEST)/INCORRECT AIRFLOW THROUGH CLIMATE CONTROL OUTLETS**

TEST STEP	ACTION TO TAKE
<b>Q2 CHECK CLIMATE CONTROL VACUUM RESERVOIR SUPPLY LINE CONNECTION</b> <ul style="list-style-type: none"> <li>Check the vacuum supply line to the climate control vacuum reservoir for a secure connection.</li> <li><b>Is the vacuum supply line securely connected?</b></li> </ul>	Yes = GO to <b>Q3</b> . No = RECONNECT the vacuum supply line.
<b>Q3 CHECK VACUUM RESERVOIR CHECK VALVE</b> <ul style="list-style-type: none"> <li>Disconnect the vacuum lines from the vacuum reservoir.</li> </ul> <p><b>NOTE:</b> Vacuum should remain constant when applied to the vacuum reservoir port for the vacuum line leading to the passenger compartment and there should be no vacuum when applied to the port for the vacuum line leading to the vacuum tee assembly. Airflow through the check valve should be in the direction towards the vacuum pump.</p> <ul style="list-style-type: none"> <li>Use Vacuum Tester to apply 103 kPa (15 psi) of vacuum to both ports on the vacuum reservoir.</li> <li><b>Is the vacuum reservoir check valve OK?</b></li> </ul>	Yes = RECONNECT the vacuum lines. GO to <b>Q4</b> . No = REPLACE the climate control vacuum reservoir.
<b>Q4 CHECK CLIMATE CONTROL VACUUM RESERVOIR FOR VACUUM LEAK</b> <ul style="list-style-type: none"> <li>With key ON, disconnect the vacuum line leading to the passenger compartment from the climate control vacuum reservoir and plug the port on the vacuum reservoir.</li> <li>Monitor interface adapter assembly (IAA) module PID VACPRES for a change in vacuum pressure after the vacuum pump shuts off.</li> <li><b>Does the vacuum level remain constant?</b></li> </ul>	Yes = RECONNECT the vacuum line to the vacuum reservoir. GO to <b>Q5</b> . No = REPLACE the climate control vacuum reservoir.
<b>Q5 CHECK VACUUM LINE TO PASSENGER COMPARTMENT</b> <ul style="list-style-type: none"> <li>With key ON, disconnect the vacuum line in the passenger compartment located on the right side of the bulkhead and plug the port on the bulkhead.</li> <li>Monitor IAA module PID VACPRES for a change in vacuum pressure after the vacuum pump shuts off.</li> <li><b>Does the vacuum level remain constant?</b></li> </ul>	Yes = RECONNECT the vacuum line to the bulkhead port. GO to <b>Q6</b> . No = REPLACE the vacuum line between the climate control vacuum reservoir and bulkhead.
<b>Q6 CHECK BLACK VACUUM LINE TO MODE SELECT SWITCH</b> <ul style="list-style-type: none"> <li>With key ON, disconnect the vacuum connector from the mode select switch and plug the black vacuum line on the vacuum connector.</li> <li>Monitor IAA module PID module VACPRES for a change in vacuum pressure after the vacuum pump shuts off.</li> <li><b>Does the vacuum level remain constant?</b></li> </ul>	Yes = RECONNECT the vacuum connector to the mode select switch. GO to <b>Q8</b> . No = GO to <b>Q7</b> .
<b>Q7 CHECK BLACK VACUUM LINE IN VACUUM JUMPER HARNESS</b> <ul style="list-style-type: none"> <li>With key ON, disconnect the vacuum jumper harness leading to the heater plenum and plug the black vacuum line port on the heater plenum vacuum connector.</li> <li>Monitor IAA module PID VACPRES for a change in vacuum pressure after the vacuum pump shuts off.</li> <li><b>Does the vacuum level remain constant?</b></li> </ul>	Yes = REPLACE the vacuum jumper harness. No = REPLACE the heater plenum vacuum line assembly.
<b>Q8 CHECK MODE SELECT SWITCH</b>	

(Continued)



**DIAGNOSIS AND TESTING (Continued)****PINPOINT TEST Q: VACUUM PUMP CYCLES ON AND OFF WITHOUT BRAKE PEDAL ACTIVATION (CLIMATE CONTROL VACUUM SYSTEM LEAK TEST)/INCORRECT AIRFLOW THROUGH CLIMATE CONTROL OUTLETS**

TEST STEP	ACTION TO TAKE
<ul style="list-style-type: none"> <li>• With key OFF, disconnect the vacuum jumper harness leading to the heater plenum and plug all ports on the blue vacuum jumper harness connector except for the black vacuum line port.</li> <li>• Use Vacuum Tester to apply 103 kPa (15 psi) of vacuum to the black vacuum line port on the blue vacuum jumper harness connector and rotate the mode select knob through all mode positions.</li> <li>• <b>Does the vacuum level remain constant for all mode positions?</b></li> </ul>	Yes = RECONNECT the vacuum jumper harness. GO to <b>Q10</b> .  No = GO to <b>Q9</b> .
<b>Q9 CHECK VACUUM JUMPER HARNESS</b> <ul style="list-style-type: none"> <li>• With key OFF, disconnect the vacuum jumper harness from the mode select switch.</li> <li>• Use Vacuum Tester to apply 103 kPa (15 psi) to each individual vacuum line with the other end of the vacuum line plugged.</li> <li>• <b>Do all vacuum lines hold vacuum?</b></li> </ul>	Yes = REPLACE the mode select switch.  No = REPLACE the vacuum jumper harness.
<b>Q10 VERIFY VACUUM LINE ROUTING</b> <ul style="list-style-type: none"> <li>• Compare vacuum line colors in each harness to the vacuum schematic. Refer to <b>Electrical and Vacuum Troubleshooting Manual (EVTM), Cell 53, Heater or Cell 54, Air Conditioner/Heater</b>.</li> <li>• <b>Is the vacuum line routing correct?</b></li> </ul>	Yes = GO to <b>Q11</b> .  No = CORRECT the vacuum line routing.
<b>Q11 CHECK VACUUM LINES/CONNECTIONS</b> <ul style="list-style-type: none"> <li>• Check each vacuum line for a secure connection. Also check for blocked, pinched, kinked, or damaged vacuum lines.</li> <li>• <b>Are the vacuum lines OK?</b></li> </ul>	Yes = GO to <b>Q12</b> .  No = REPAIR as necessary.
<b>Q12 CHECK VACUUM MOTORS</b> <ul style="list-style-type: none"> <li>• Disconnect the vacuum line from each vacuum motor and use Vacuum Tester to apply 103 kPa (15 psi) of vacuum to each vacuum motor.</li> <li>• <b>Do the vacuum motors hold vacuum?</b></li> </ul>	Yes = GO to <b>Q13</b> .  No = REPLACE the vacuum motor(s) in question.
<b>Q13 CHECK WHITE VACUUM LINE TO FRESH/RECIRCULATION DOOR VACUUM MOTOR</b> <ul style="list-style-type: none"> <li>• With key ON, remove the white vacuum line from the fresh/recirculation door vacuum motor and plug the vacuum line.</li> <li>• Monitor IAA module PID VACPRES for a change in vacuum pressure after the vacuum pump shuts off.</li> <li>• <b>Does the vacuum level remain constant?</b></li> </ul>	Yes = RECONNECT the white vacuum line to the fresh/recirculation door vacuum motor. GO to <b>Q14</b> .  No = REPLACE the heater plenum vacuum line assembly.
<b>Q14 CHECK YELLOW VACUUM LINE TO FLOOR/DEFROST DOOR VACUUM MOTOR</b> <ul style="list-style-type: none"> <li>• With key ON, remove the yellow vacuum line from the floor/defrost door vacuum motor and plug the hose.</li> <li>• Monitor IAA module PID VACPRES for a change in vacuum pressure after the vacuum pump shuts off.</li> <li>• <b>Does the vacuum level remain constant?</b></li> </ul>	Yes = RECONNECT the yellow vacuum line to the floor/defrost door vacuum motor. GO to <b>Q15</b> .  No = REPLACE the heater plenum vacuum line assembly.
<b>Q15 CHECK BLUE VACUUM LINE TO FLOOR/DEFROST DOOR VACUUM MOTOR</b>	

(Continued)

**DIAGNOSIS AND TESTING (Continued)****PINPOINT TEST Q: VACUUM PUMP CYCLES ON AND OFF WITHOUT BRAKE PEDAL ACTIVATION (CLIMATE CONTROL VACUUM SYSTEM LEAK TEST)/INCORRECT AIRFLOW THROUGH CLIMATE CONTROL OUTLETS**

TEST STEP	ACTION TO TAKE
<ul style="list-style-type: none"> <li>With key ON, remove the blue vacuum line from the floor/defrost door vacuum motor and plug the vacuum line.</li> <li>Monitor IAA module PID VACPRES for a change in vacuum pressure after the vacuum pump shuts off.</li> <li><b>Does the vacuum level remain constant?</b></li> </ul>	Yes = RECONNECT the blue vacuum line to the floor/defrost door vacuum motor. GO to <b>Q16</b> . No = REPLACE the heater plenum vacuum line assembly.
<b>Q16 CHECK RED VACUUM LINE TO PANEL/DEFROST DOOR VACUUM MOTOR</b> <ul style="list-style-type: none"> <li>With key ON, set the mode select knob to the PANEL/FLOOR position, remove the red vacuum line from the panel/defrost door vacuum motor and plug the vacuum line.</li> <li>Monitor IAA module PID VACPRES for a change in vacuum pressure after the vacuum pump shuts off.</li> <li><b>Does the vacuum level remain constant?</b></li> </ul>	Yes = RECONNECT the red vacuum line to the panel/defrost door vacuum motor. GO to <b>Q17</b> . No = REPLACE the heater plenum vacuum line assembly.
<b>Q17 CHECK GREEN VACUUM LINE TO RECIRCULATION VACUUM SOLENOID</b> <ul style="list-style-type: none"> <li>With key ON, set the mode select knob to the OFF position, disconnect the green vacuum line from the recirculation vacuum solenoid, and plug the vacuum line.</li> <li>Monitor IAA module PID VACPRES for a change in vacuum pressure after the vacuum pump shuts off.</li> <li><b>Does the vacuum level remain constant?</b></li> </ul>	Yes = System OK. CHECK for intermittent vacuum line connections. No = REPLACE the heater plenum vacuum line assembly.

**PINPOINT TEST R: RECIRCULATION FUNCTION DOES NOT OPERATE**

TEST STEP	ACTION TO TAKE
<b>R1 CHECK RECIRCULATION FUNCTION (FRESH POSITION)</b> <ul style="list-style-type: none"> <li>With key ON, set the mode select knob to the PANEL/FLOOR position and check the position of the outside/recirculation door.</li> <li><b>Is the outside/recirculation door in the fresh position?</b></li> </ul>	Yes = GO to <b>R3</b> . No = GO to <b>R2</b> .
<b>R2 CHECK FRESH/RECIRCULATION DOOR VACUUM MOTOR ACTUATOR</b> <ul style="list-style-type: none"> <li>With key ON, set the mode select knob to the PANEL/FLOOR position, disconnect the white vacuum line from the fresh/recirculation door vacuum motor, and check the position of the outside/recirculation door.</li> <li><b>Is the outside/recirculation door in the fresh position?</b></li> </ul>	Yes = GO to <b>R3</b> . No = CHECK for binding actuator/linkage. If OK, CHECK for stuck recirculation vacuum solenoid. REPAIR as necessary.
<b>R3 CHECK RECIRCULATION FUNCTION (RECIRCULATION POSITION)</b>  <b>NOTE:</b> If the LED on the fresh/recirculation select switch does not illuminate when the fresh/recirculation select switch is depressed, GO to <b>R17</b> . <ul style="list-style-type: none"> <li>With key ON, set the mode select knob to the PANEL/FLOOR position, depress the fresh/recirculation select switch, and check the position of the outside/recirculation door.</li> </ul>	Yes = System OK. CHECK wiring/vacuum lines for intermittent connections.

(Continued)

**DIAGNOSIS AND TESTING (Continued)****PINPOINT TEST R: RECIRCULATION FUNCTION DOES NOT OPERATE**

TEST STEP	ACTION TO TAKE
<ul style="list-style-type: none"> <li>• Is the outside/recirculation door in the recirculation position?</li> </ul>	No = GO to <b>R4</b> .
<b>R4 CHECK OPERATION OF RECIRCULATION VACUUM SOLENOID</b> <ul style="list-style-type: none"> <li>• With key ON, set the mode select knob to the FLOOR/PANEL position.</li> <li>• Enter the interface adapter assembly (IAA) module active command mode CLIMATE CONTROL COMMAND and set the active commands MAINT VAC to YES and RECIR SOL to ON.</li> <li>• Check the position of the outside/recirculation door.</li> <li>• Is the outside/recirculation door in the recirculation position?</li> </ul>	Yes = GO to <b>R13</b> . No = GO to <b>R5</b> .
<b>R5 CHECK POWER TO IN-LINE C2999</b> <ul style="list-style-type: none"> <li>• With key OFF, disconnect in-line C2999.</li> <li>• With key ON, measure the voltage between pin 8 (Y/LG wire) and pin 7 (BK wire) on in-line C2999.</li> <li>• Is the voltage greater than 10 volts?</li> </ul>	Yes = RECONNECT in-line C2999. GO to <b>R9</b> . No = GO to <b>R6</b> .
<b>R6 CHECK GROUND TO IN-LINE C2999</b> <ul style="list-style-type: none"> <li>• With key OFF, measure the resistance between pin 7 (BK wire) on in-line C2999 and ground.</li> <li>• Is the resistance less than 5 ohms?</li> </ul>	Yes = GO to <b>R7</b> . No = REPAIR the BK wire.
<b>R7 CHECK CIRCUIT 3052 (Y/LG) FOR OPEN</b> <ul style="list-style-type: none"> <li>• Connect 104-Pin Breakout Box (BOB) to IAA module C1945; leave IAA module disconnected.</li> <li>• With key OFF, measure the resistance of the Y/LG wire between pin 8 on in-line C2999 and BOB pin 35.</li> <li>• Is the resistance less than 5 ohms?</li> </ul>	Yes = GO to <b>R8</b> . No = REPAIR the Y/LG wire.
<b>R8 CHECK CIRCUIT 3052 (Y/LG) FOR SHORT TO GROUND</b> <ul style="list-style-type: none"> <li>• With key OFF, measure the resistance between BOB pin 35 and ground (BOB pin 80).</li> <li>• Is the resistance greater than 10,000 ohms?</li> </ul>	Yes = REPLACE the IAA module. REFER to <a href="#">Section 412-04</a> . No = REPAIR the Y/LG wire.
<b>R9 CHECK POWER TO RECIRCULATION VACUUM SOLENOID</b> <ul style="list-style-type: none"> <li>• With key OFF, disconnect recirculation vacuum solenoid C2994.</li> <li>• With key ON, measure the voltage between the Y/LG wire and BK wire on recirculation vacuum solenoid C2994.</li> <li>• Is the voltage greater than 10 volts?</li> </ul>	Yes = GO to <b>R11</b> . No = GO to <b>R10</b> .
<b>R10 CHECK GROUND TO RECIRCULATION VACUUM SOLENOID</b> <ul style="list-style-type: none"> <li>• With key OFF, measure the resistance between the BK wire on recirculation vacuum solenoid C2994 and ground.</li> <li>• Is the resistance less than 5 ohms?</li> </ul>	Yes = GO to <b>R11</b> . No = REPAIR the BK wire.
<b>R11 CHECK VACUUM FROM RECIRCULATION VACUUM SOLENOID</b> <ul style="list-style-type: none"> <li>• With key ON, set the mode select knob to the OFF position, disconnect the white vacuum line from the recirculation vacuum solenoid, and check for vacuum.</li> <li>• Is vacuum present?</li> </ul>	Yes = CHECK the fresh/recirculation door vacuum motor for vacuum leak. REPLACE if necessary. No = GO to <b>R12</b> .
<b>R12 CHECK VACUUM TO RECIRCULATION VACUUM SOLENOID</b>	

(Continued)

**DIAGNOSIS AND TESTING (Continued)****PINPOINT TEST R: RECIRCULATION FUNCTION DOES NOT OPERATE**

TEST STEP	ACTION TO TAKE
<ul style="list-style-type: none"> <li>• With key ON, disconnect the black vacuum line from the recirculation vacuum solenoid and check for vacuum.</li>   <li>• <b>Is vacuum present?</b></li> </ul>	<p>Yes = CHECK the white vacuum line to the fresh/recirculation door vacuum motor for blockage. REPAIR as necessary. If OK, REPLACE the recirculation vacuum solenoid.</p> <p>No = GO to Pinpoint Test P.</p>
<p><b>R13 CHECK CIRCUIT 3053 (BR/W) FOR OPEN</b></p> <ul style="list-style-type: none"> <li>• Connect 104-Pin Breakout Box (BOB) to IAA module C1945; leave IAA module disconnected.</li> <li>• With key OFF, disconnect fresh/recirculation select switch C2998 and measure the resistance of the BR/W wire between pin 4 on fresh/recirculation select switch C2998 and BOB pin 63.</li> <li>• <b>Is the resistance less than 5 ohms?</b></li> </ul>	<p>Yes = GO to <b>R14</b>.</p> <p>No = REPAIR the BR/W wire.</p>
<p><b>R14 CHECK CIRCUIT 3053 (BR/W) FOR SHORT TO GROUND</b></p> <ul style="list-style-type: none"> <li>• With key OFF, measure the resistance between BOB pin 63 and ground (BOB pin 80).</li> <li>• <b>Is the resistance greater than 10,000 ohms?</b></li> </ul>	<p>Yes = GO to <b>R15</b>.</p> <p>No = REPAIR the BR/W wire.</p>
<p><b>R15 CHECK GROUND TO FRESH/RECIRCULATION SELECT SWITCH</b></p> <ul style="list-style-type: none"> <li>• With key OFF, measure the resistance between pin 3 (BK wire) on fresh/recirculation select switch C2998 and ground.</li> <li>• <b>Is the resistance less than 5 ohms?</b></li> </ul>	<p>Yes = GO to <b>R16</b>.</p> <p>No = REPAIR the BK wire.</p>
<p><b>R16 CHECK FRESH/RECIRCULATION SELECT SWITCH</b></p> <ul style="list-style-type: none"> <li>• Measure the resistance between the BR/W wire terminal and BK wire terminal on the fresh/recirculation select switch with the switch depressed.</li> <li>• <b>Is the resistance less than 5 ohms?</b></li> </ul>	<p>Yes = REPLACE the IAA module. REFER to <a href="#">Section 412-04</a>.</p> <p>No = REPLACE the fresh/recirculation select switch.</p>
<p><b>R17 CHECK POWER TO FRESH/RECIRCULATION SELECT SWITCH LED</b></p> <ul style="list-style-type: none"> <li>• With key OFF, disconnect fresh/recirculation select switch C2998.</li> <li>• With key ON, measure the voltage between the pin 1 (BK/LG wire) and pin 3 (BK wire) on fresh/recirculation select switch C2998.</li> <li>• <b>Is the voltage greater than 10 volts?</b></li> </ul>	<p>Yes = REPLACE the fresh/recirculation select switch.</p> <p>No = GO to <b>R18</b>.</p>
<p><b>R18 CHECK GROUND TO FRESH/RECIRCULATION SELECT SWITCH</b></p> <ul style="list-style-type: none"> <li>• With key OFF, measure the resistance between pin 3 (BK wire) on fresh/recirculation select switch C2998 and ground.</li> <li>• <b>Is the resistance less than 5 ohms?</b></li> </ul>	<p>Yes = GO to <b>R19</b>.</p> <p>No = REPAIR the BK wire.</p>
<p><b>R19 CHECK CIRCUIT 3054 (BK/LG) FOR OPEN</b></p> <ul style="list-style-type: none"> <li>• Connect 104-Pin Breakout Box (BOB) to IAA module C1945; leave IAA module disconnected.</li> <li>• With key OFF, measure the resistance of the BK/LG wire between pin 1 on fresh/recirculation select switch C2998 and BOB pin 66.</li> <li>• <b>Is the resistance less than 5 ohms?</b></li> </ul>	<p>Yes = REPLACE the IAA module. REFER to <a href="#">Section 412-04</a>.</p> <p>No = REPAIR the BK/LG wire.</p>

**DIAGNOSIS AND TESTING (Continued)****PINPOINT TEST S: PRE-HEAT FUNCTION DOES NOT OPERATE (POSTAL RANGER EV ONLY)**

TEST STEP	ACTION TO TAKE
<b>S1 CHECK PRE-HEAT FOR CORRECT CONDITIONS</b> <ul style="list-style-type: none"> <li>• Key OFF.</li> <li>• Power Control Station (PCS) in ACTIVE mode.</li> <li>• Vehicle Plugged in.</li> <li>• Outside ambient temperature &lt;18°C (64°F)</li> <li>• <b>Are the conditions acceptable?</b></li> </ul>	Yes = GO to <b>S2</b> .  No = CORRECT the conditions.
<b>S2 CHECK PRE-HEAT SWITCH</b> <ul style="list-style-type: none"> <li>• Key OFF.</li> <li>• Depress pre-heat switch.</li> <li>• <b>Does the bulb illuminate?</b></li> </ul>	Yes = GO to <b>S3</b> .  No = REPAIR pre-heat switch and/or circuit(s).
<b>S3 CHECK CIRCUIT X(LG/BK) FOR POWER</b> <ul style="list-style-type: none"> <li>• Key OFF.</li> <li>• Disconnect pre-heat switch C262, and measure the voltage between circuit X(LG/BK) and ground.</li> <li>• <b>Is the voltage greater than 0 volts?</b></li> </ul>	Yes = GO to <b>S4</b> .  No = REPAIR the circuit.
<b>S4 CHECK THE PRE-HEAT SWITCH</b> <ul style="list-style-type: none"> <li>• Key OFF.</li> <li>• Depress the button.</li> <li>• Check circuit X(LG/BK) and circuit W(RD/LG).</li> <li>• <b>Is the resistance less than 3 ohms?</b></li> </ul>	Yes = GO to <b>S5</b> .  No = INSTALL a new switch.
<b>S5 CHECK CIRCUIT W(RD/LG) FOR POWER</b> <ul style="list-style-type: none"> <li>• Key OFF.</li> <li>• Disconnect pre-heat C262 and measure the voltage between circuit W(RD/LG) and ground.</li> <li>• <b>Is the voltage greater than 0 volts?</b></li> </ul>	Yes = GO to <b>S6</b> .  No = REPAIR the circuit.
<b>S6 CHECK THE PRE-HEAT INVERTER RELAY</b> <ul style="list-style-type: none"> <li>• Disconnect the pre-heat inverter relay C135.</li> <li>• Carry out the component test on the pre-heat inverter relay. Refer to the wiring diagrams section for component testing.</li> <li>• <b>Is the pre-heat relay OK?</b></li> </ul>	Yes = GO to <b>S7</b> .  No = INSTALL a new relay.
<b>S7 CHECK CIRCUIT Y(WH) POWER</b> <ul style="list-style-type: none"> <li>• Key OFF.</li> <li>• Depress the pre-heat switch button.</li> <li>• <b>Is the voltage greater than 0 volts?</b></li> </ul>	Yes = GO to <b>S8</b> .  No = REPAIR the circuit.
<b>S8 CHECK CIRCUIT Y(BK) FOR POWER</b> <ul style="list-style-type: none"> <li>• Key OFF.</li> <li>• Disconnect the Interface Adapter Assembly C1945 and measure the voltage between Y(BK) and ground.</li> <li>• <b>Is the voltage greater than 0 volts?</b></li> </ul>	Yes = INSTALL a new Interface Adapter Assembly (IAA).  No = REPAIR the circuit.

## REMOVAL AND INSTALLATION

### PTC Heater Core —Electric Ranger

#### Removal

1. Disconnect the traction battery auxiliary load high-voltage connector. Refer to [Section 100-05](#).
2. Remove the instrument panel. Refer to the **2001 Ranger Workshop Manual**.
3. **NOTE:** The evaporator housing nut is located inside the vehicle, on the lower bulkhead, on the passenger side.  
Remove the evaporator housing nut.

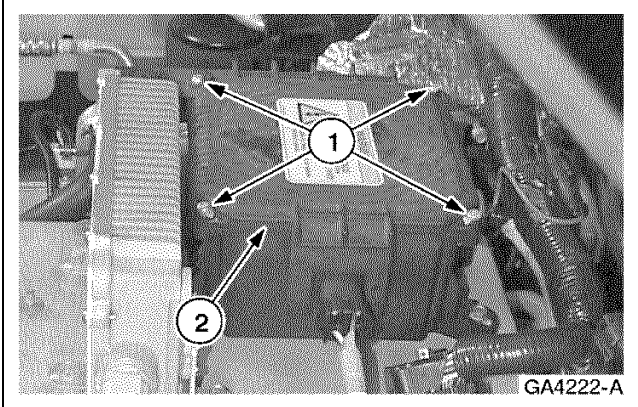
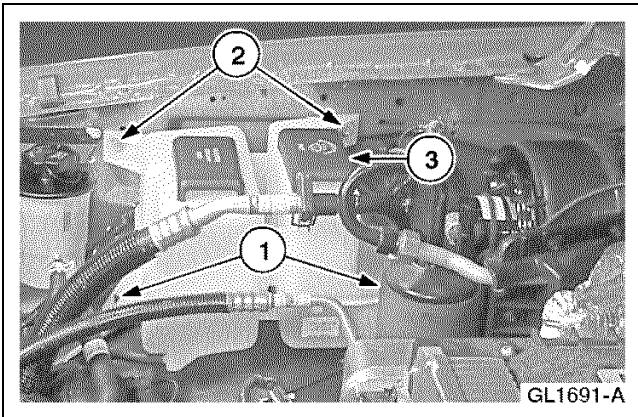
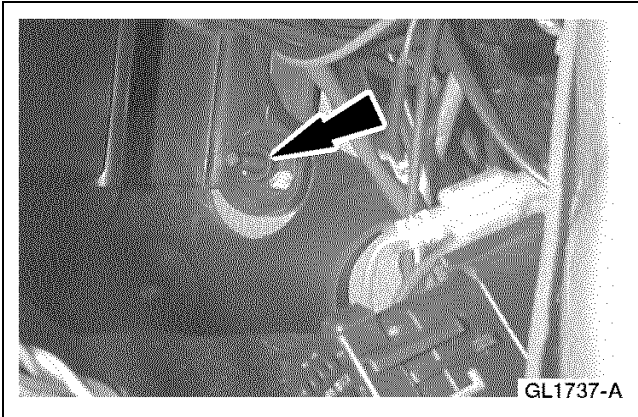

4. Position the reservoir aside.
  - 1 Remove the nuts.
  - 2 Remove the bolts.
  - 3 Position the reservoir toward the front of the vehicle.
5. Remove the high-voltage power distribution box cover.
  - 1 Remove the screws.
  - 2 Remove the cover.

## REMOVAL AND INSTALLATION (Continued)

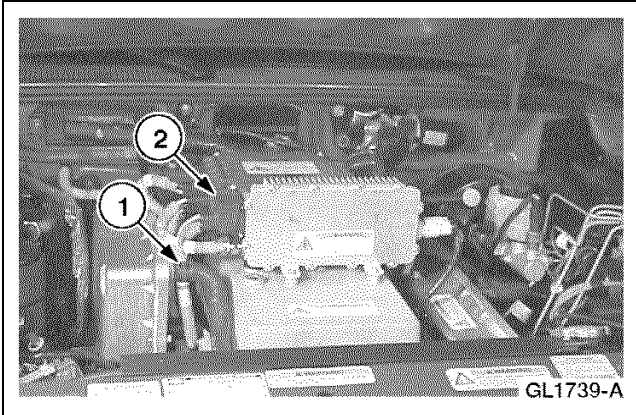

6. Disconnect the positive temperature coefficient (PTC) heater core electrical connector.

- 1 Disconnect the PTC heater core harness clip.
- 2 Disconnect the electrical connector.

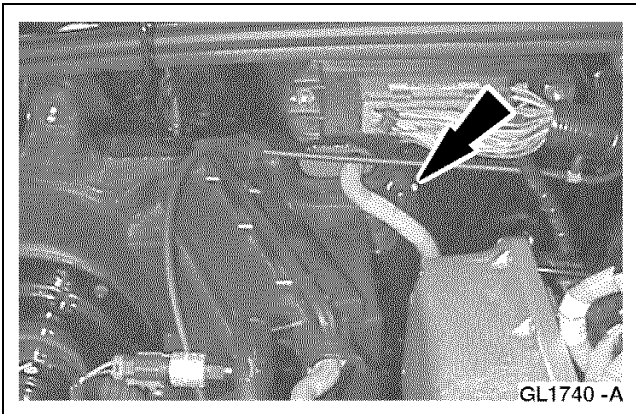

7. Disconnect the harness clip.

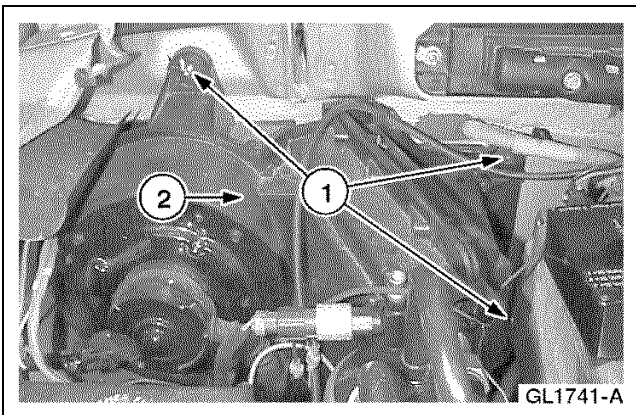

8. Position the evaporator housing forward.

- 1 Remove the nuts.
- 2 Position the evaporator housing approximately two inches toward the front of the vehicle.

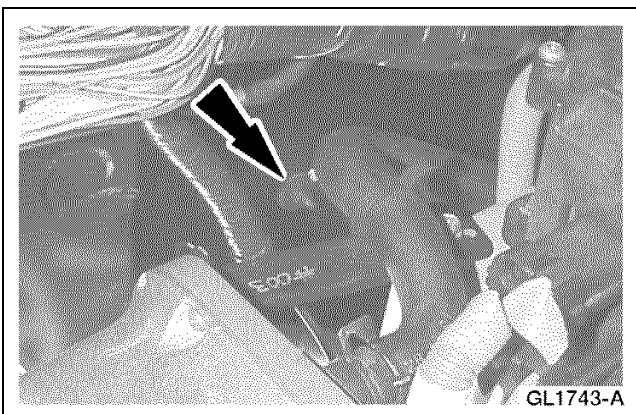

9. **NOTE:** The nut is located in the center of the bulkhead, behind the traction battery charger. Remove the heater plenum retaining nut.

## REMOVAL AND INSTALLATION (Continued)

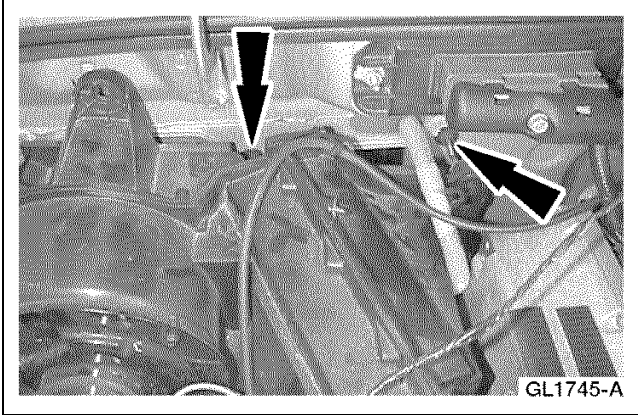

10. Remove the two upper heater plenum retaining nuts.

11. **NOTE:** The lower nut is located behind the lower driver side of the evaporator housing. Remove the lower heater plenum retaining nut.

12. Remove the heater plenum from the inside of the vehicle.
  - Feed the PTC heater core electrical harness through the bulkhead.

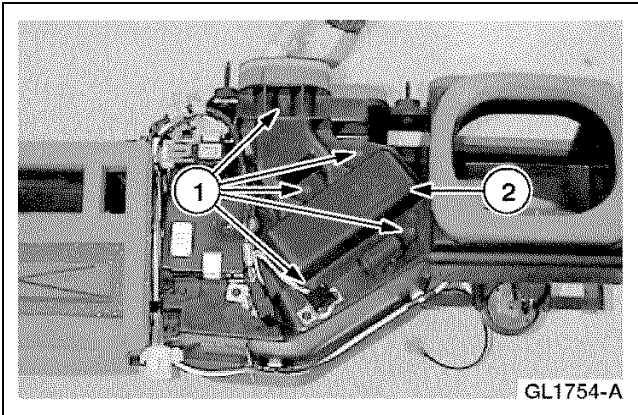

13. Remove the PTC heater core cover.
  - 1 Remove the screws.
  - 2 Remove the cover.

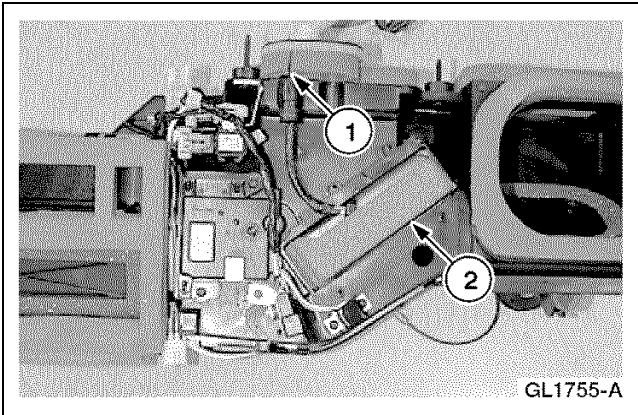

14. **⚠ CAUTION: Do not damage the insulation around the PTC heater core electrical harness. The insulation is reused when the PTC heater core is replaced.** Remove the PTC heater core.
  - 1 Cut the insulation to allow removal of the PTC heater core electrical harness.
  - 2 Remove the PTC heater core.



**REMOVAL AND INSTALLATION (Continued)****Installation**

1. **NOTE:** Remove the insulation from the electrical harness of the new PTC heater core prior to installation.  
To install, reverse the removal procedure.

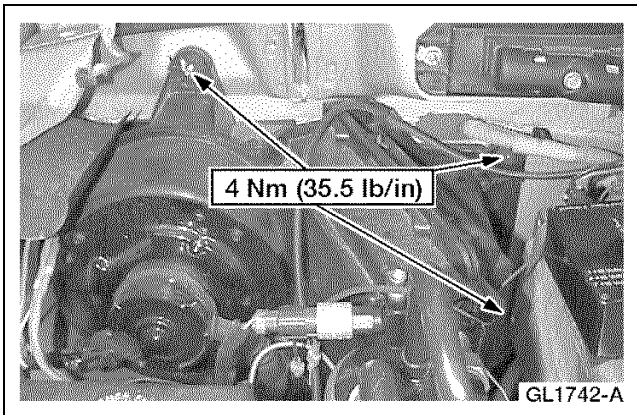
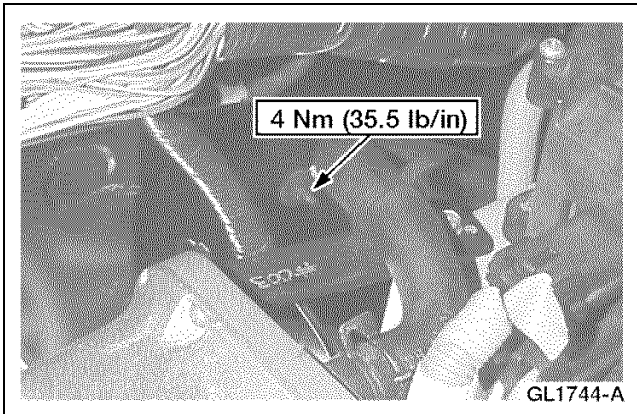
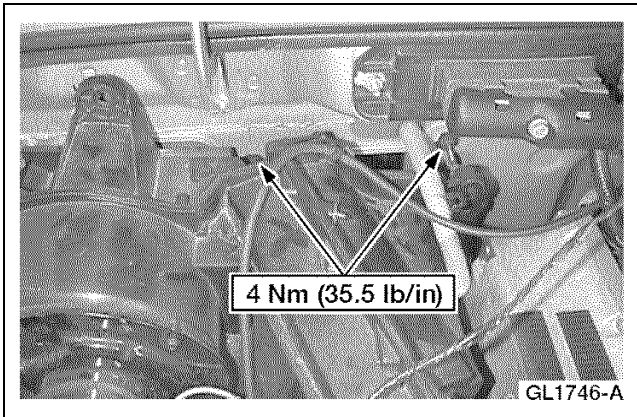
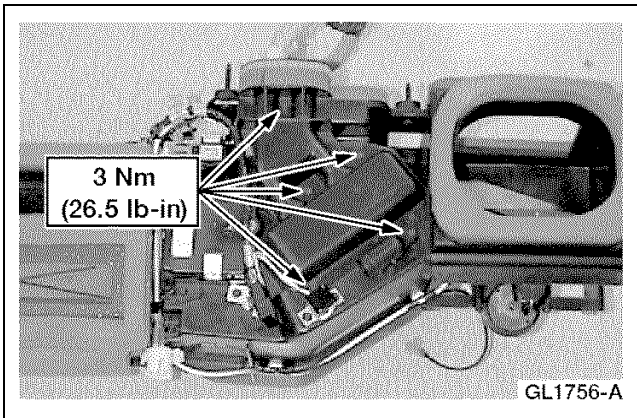

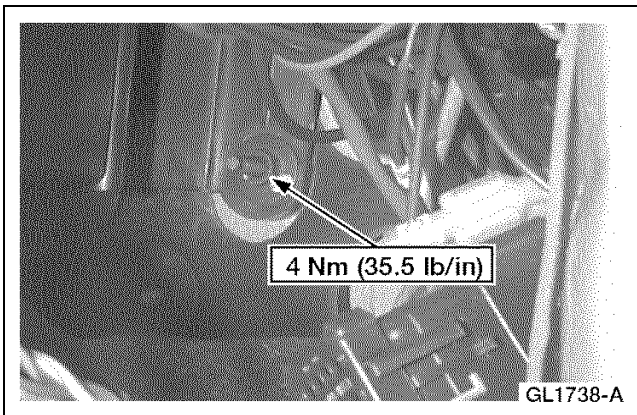
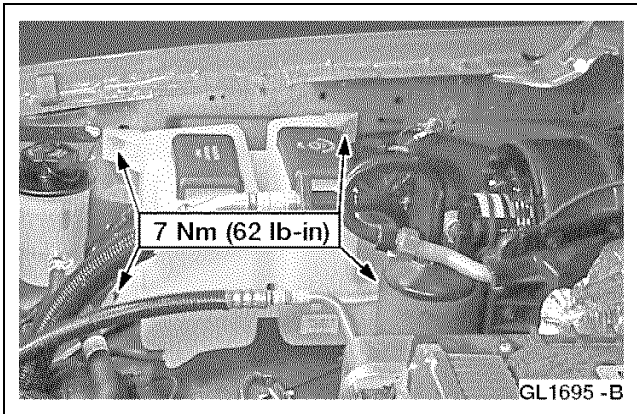
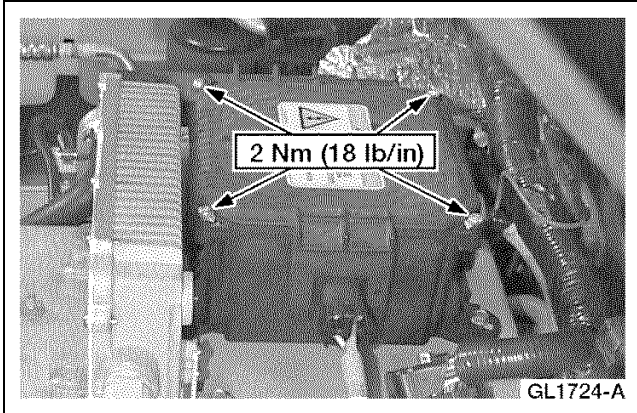
**REMOVAL AND INSTALLATION (Continued)****PTC Heater Core —Postal Ranger EV****Removal and Installation**

1. Disconnect the traction battery auxiliary load high-voltage connector. Refer to [Section 100-05](#).

## REMOVAL AND INSTALLATION (Continued)

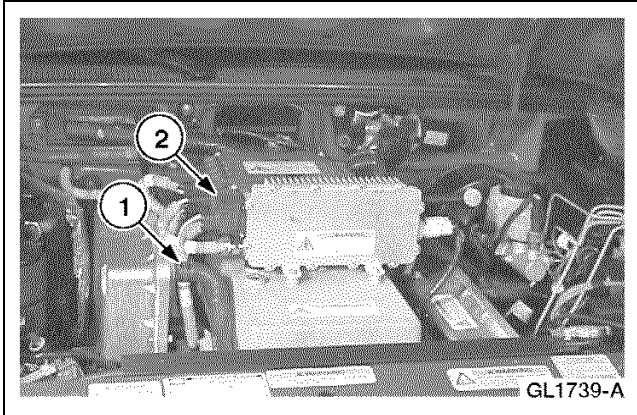

2. **NOTE:** Electric Ranger shown, Postal Ranger EV similar.

Disconnect the positive temperature coefficient (PTC) heater core electrical connector.

- 1 Disconnect the wiring harness clip.
- 2 Disconnect the electrical connector.

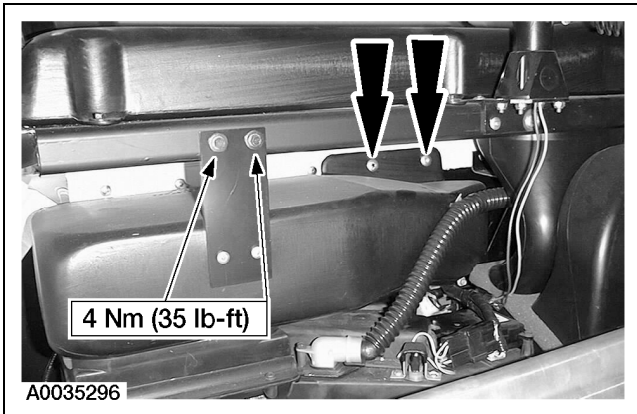

3. Remove the LH ventilation duct.

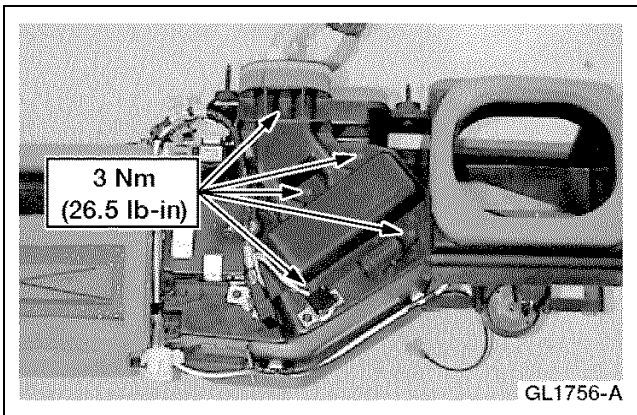

4. **NOTE:** The PTC heater case is removed for clarity.

Remove the PTC heater core cover 6 bolts and remove the cover.

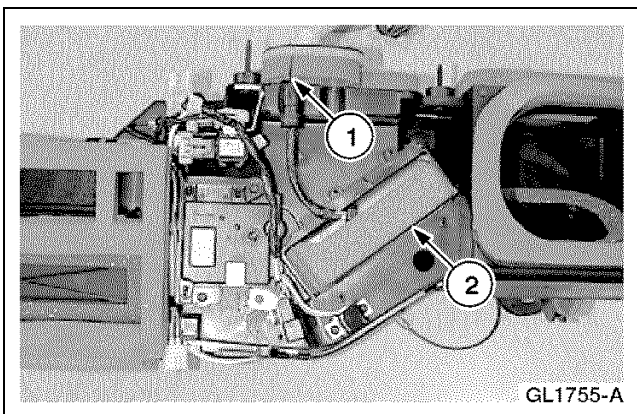

5. **⚠ CAUTION: Do not damage the insulation around the PTC heater core electrical harness. The insulation is reused when the PTC heater core is replaced.**

Remove the PTC heater core.

- 1 Cut the insulation to allow removal of the PTC heater core electrical harness.
- 2 Remove the PTC heater core.

---

**REMOVAL AND INSTALLATION (Continued)**

6. **NOTE:** Remove the insulation from this electrical harness of the new PTC heater core prior to installation.

To install, reverse the removal procedure.

---

 Manual Table of Contents

## SECTION 412-03 Air Conditioning

VEHICLE APPLICATION: Ranger EV

CONTENTS	PAGE
<b>SPECIFICATIONS</b> .....	412-03-2
<b>DESCRIPTION AND OPERATION</b>	
A/C Inverter Motor Controller.....	412-03-2
Air Conditioning .....	412-03-2
Compressor .....	412-03-2
<b>DIAGNOSIS AND TESTING</b>	
Air Conditioning .....	412-03-3
Electrical Schematic .....	412-03-3
Inspection and Verification .....	412-03-3
Pinpoint Tests.....	412-03-4
Symptom Chart .....	412-03-3
<b>REMOVAL AND INSTALLATION</b>	
A/C Compressor.....	412-03-12
A/C Inverter Motor Controller.....	412-03-15

## SPECIFICATIONS

### General Specifications

Item	Specification
A/C Refrigerant R134a	WSH-M17B19-A
Polyolester Compressor Oil	WSS-M2C31-B

### Torque Specifications

Description	Nm	Lb-Ft	Lb-In
A/C compressor bolts	22.5	16.5	—
A/C inverter motor controller bolts	12	—	107
Electric cooling fan bolts	7	—	62.5
High side A/C line bolts	22	16	—
Low side A/C line bolts	22	16	—

## DESCRIPTION AND OPERATION

### A/C Inverter Motor Controller

The A/C compressor is supplied power by the A/C inverter motor controller (IMC), which is located in the underhood compartment next to the traction battery charger on the passenger side. Traction battery voltage is fed to the A/C IMC through the high-voltage power distribution box (HVPDB), and this is converted into high-voltage alternating current. Six insulated gate bipolar transistors are incorporated into the A/C IMC for efficient operation. Coolant is circulated through the controller to remove heat that is generated during operation.

### Air Conditioning

The A/C system on the Electric Ranger uses a high-voltage motor driven compressor. The evaporator and plenum assemblies are new, but are located in the same position as the gasoline-powered Ranger. To remove and install any components other than the compressor and the A/C inverter motor controller, refer to the **Ranger service manual**.

Based upon driver demands, the interface adapter assembly (IAA) module varies the power output of the A/C inverter motor controller (IMC), which controls the compressor output. The A/C system is limited to cooling the passenger compartment to 18.5°C (65°F) in order to conserve traction battery power.

### Compressor

The compressor for the Electric Ranger is located in the underhood compartment below and in front of the traction battery charger. The compressor is driven by an electric motor that is powered by high voltage from the A/C inverter motor controller (IMC). Compressor speed is varied based upon cooling demands. The compressor has a maximum speed of 7812 rpm and is protected by an over-temperature sensor. The oil used in the A/C system is a new Polyolester type and is not compatible with any other A/C oil or leak detection dyes. Using any other oil may cause damage to the A/C system.

## DIAGNOSIS AND TESTING

### Air Conditioning

#### Diagnostic Trouble Code (DTC) Definition

The following DTCs relate to the air conditioning (A/C) system:

- DTC P1461 A/C Pressure Sensor Circuit High Input
  - The interface adapter assembly (IAA) module uses the A/C pressure sensor to monitor the pressure on the high side of the A/C compressor. The IAA module sets DTC P1461 when the ambient temperature is greater than 18°C (64°F) and the pressure has been less than 80 kPa (12 psi) or greater than 3275 kPa (475 psi) for more than 30 seconds.
- DTC B1946 A/C Post Evaporator Sensor Circuit Failure
  - The interface adapter assembly (IAA) module uses the evaporator temperature sensor to monitor the temperature of the A/C evaporator core. The IAA module sets DTC B1946 if the evaporator temperature is greater than 55°C (131°F) or less than -40°C (-40°F) for more than 30 seconds while the A/C is running.
- DTC B2119 Compressor Failure
  - The interface adapter assembly (IAA) module monitors the A/C compressor speed feedback signal from the A/C inverter motor controller (IMC) to determine if the A/C compressor is not operating when it should be. If the IAA module is commanding 14% duty cycle and the compressor speed does not increase above 250 rpms for 30 seconds, DTC B2119 is set.

- DTC B2518 Compressor Overtemperature Fault
  - The interface adapter assembly (IAA) module uses the A/C overtemperature sensor to monitor the temperature of the A/C compressor. The IAA module sets DTC B2606 if the compressor temperature is greater than 77°C (171°F) for more than 5 seconds. If this occurs, the A/C compressor will be disabled. The compressor will turn back on when the temperature decreases below 67°C (153°F).
- DTC B2606 A/C Temperature Sensor Out of Range
  - The interface adapter assembly (IAA) module uses the A/C overtemperature sensor to monitor the temperature of the A/C compressor. The IAA module sets DTC B2518 if the compressor temperature is greater than 125°C (257°F) or less than -40°C (-40°F) for more than 30 seconds. If this occurs, the A/C compressor will be disabled.

#### Electrical Schematic

Refer to **Electrical and Vacuum Troubleshooting Manual, Cell 54, Air Conditioner/Heater** for schematic and connector information.

#### Inspection and Verification

Refer to [Section 100-07](#).

### Symptom Chart

#### Symptom Chart

Condition	Possible Sources	Action
<ul style="list-style-type: none"> <li>• DTC P1461 A/C Pressure Sensor Circuit High Input</li> </ul>	<ul style="list-style-type: none"> <li>• Low refrigerant.</li> <li>• Refrigerant leak.</li> <li>• Circuit(s).</li> <li>• Interface adapter assembly (IAA) module.</li> <li>• A/C pressure sensor.</li> </ul>	<ul style="list-style-type: none"> <li>• GO to <a href="#">Pinpoint Test A.</a></li> </ul>
<ul style="list-style-type: none"> <li>• DTC B1946 A/C Post Evaporator Sensor Circuit Failure</li> </ul>	<ul style="list-style-type: none"> <li>• Evaporator temperature sensor.</li> <li>• Circuit(s).</li> <li>• Interface adapter assembly (IAA) module.</li> </ul>	<ul style="list-style-type: none"> <li>• GO to <a href="#">Pinpoint Test B.</a></li> </ul>

**DIAGNOSIS AND TESTING (Continued)****Symptom Chart (Continued)**

Condition	Possible Sources	Action
<ul style="list-style-type: none"> <li>DTC B2119 Compressor Failure</li> </ul>	<ul style="list-style-type: none"> <li>A/C inverter motor controller (IMC).</li> <li>Circuit(s).</li> <li>Interface adapter assembly (IAA) module.</li> <li>A/C compressor.</li> </ul>	<ul style="list-style-type: none"> <li>GO to <a href="#">Pinpoint Test C</a>.</li> </ul>
<ul style="list-style-type: none"> <li>DTC B2518 Compressor Overtemperature Fault</li> </ul>	<ul style="list-style-type: none"> <li>Overtemperature condition.</li> <li>A/C compressor (A/C overtemperature sensor).</li> <li>Interface adapter assembly (IAA) module.</li> </ul>	<ul style="list-style-type: none"> <li>GO to <a href="#">Pinpoint Test D</a>.</li> </ul>
<ul style="list-style-type: none"> <li>DTC B2606 A/C Temperature Sensor Out of Range</li> </ul>	<ul style="list-style-type: none"> <li>Circuit(s).</li> <li>A/C compressor (A/C overtemperature sensor).</li> <li>Interface adapter assembly (IAA) module.</li> </ul>	<ul style="list-style-type: none"> <li>GO to <a href="#">Pinpoint Test E</a>.</li> </ul>
<ul style="list-style-type: none"> <li>A/C Compressor Does Not Operate (No Cooling)</li> </ul>	<ul style="list-style-type: none"> <li>Low refrigerant.</li> <li>Refrigerant leak.</li> <li>A/C low pressure switch.</li> <li>Interface adapter assembly (IAA) module.</li> <li>Circuit(s).</li> <li>A/C inverter motor controller (IMC).</li> <li>High-voltage power distribution box (HVPDB).</li> <li>High-voltage A/C fuse.</li> </ul>	<ul style="list-style-type: none"> <li>GO to <a href="#">Pinpoint Test F</a>.</li> </ul>

**Pinpoint Tests****Special Tool(s)**

104-Pin Breakout Box (BOB) 418-049 (014-00950) or equivalent
Capacitor Discharge Tool 418-F213

(Continued)

**Special Tool(s)**

R-134a Manifold Gauge Set 176-R032A or equivalent
R-12/R-134a Air Conditioning Test Fitting Set 412-DS028 (014-00333) or equivalent
A/C Pressure Test Adapter 412-093 (T94P-19623-E)

**PINPOINT TEST A: DTC P1461 A/C PRESSURE SENSOR CIRCUIT HIGH INPUT**

TEST STEP	ACTION TO TAKE
<b>A1 CHECK A/C PRESSURE</b> <ul style="list-style-type: none"> <li>With key ON, set the mode select knob to the A/C position, the temperature control knob to full cool position, and the blower control knob to HIGH speed position, and monitor the interface adapter assembly (IAA) module PID A/CPRES.</li> <li><b>Is the pressure between 80 and 3275 kPa (12 and 475 psi)?</b></li> </ul>	Yes = System OK. CHECK wiring for intermittent connections. CHECK the refrigerant system for proper operation. No = If pressure is less than 80 kPa (12 psi), GO to <b>A2</b> . If pressure is greater than 3275 kPa (475 psi), GO to <b>A3</b> .
<b>A2 CHECK A/C SYSTEM PRESSURE</b> <ul style="list-style-type: none"> <li>Connect R-134a Manifold Gauge Set to charge ports and observe the A/C system pressure.</li> </ul>	Yes = GO to <b>A3</b> .

(Continued)



**DIAGNOSIS AND TESTING (Continued)****PINPOINT TEST A: DTC P1461 A/C PRESSURE SENSOR CIRCUIT HIGH INPUT**

<b>TEST STEP</b>	<b>ACTION TO TAKE</b>
<ul style="list-style-type: none"> <li>Is the pressure above 345 kPa (50 psi)?</li> </ul>	No = CHECK the refrigerant system for leaks. REPAIR as necessary. RECHARGE the A/C system.
<b>A3 CHECK A/C PRESSURE SENSOR VOLTAGE REFERENCE</b> <ul style="list-style-type: none"> <li>With key OFF, disconnect A/C pressure sensor C1994.</li> <li>With key ON, measure the voltage between pin 1 (BK/PK wire) and pin 2 (DG/O wire) on A/C pressure sensor C1994.</li> <li>Is the voltage between 4.8 and 5.2 volts?</li> </ul>	Yes = GO to A6. No = GO to A4.
<b>A4 CHECK CIRCUITS 3030 (DG/O) AND 3031 (BK/PK) FOR OPEN(S)</b> <ul style="list-style-type: none"> <li>Connect 104-Pin Breakout Box (BOB) to IAA module C1945; leave IAA module disconnected.</li> <li>With key OFF, measure the resistance of the DG/O wire between pin 2 on A/C pressure sensor C1994 and BOB pin 86.</li> <li>With key OFF, measure the resistance of the BK/PK wire between pin 1 on A/C pressure sensor C1994 and BOB pin 82.</li> <li>Are the resistances less than 5 ohms?</li> </ul>	Yes = GO to A5. No = REPAIR the wire(s) in question.
<b>A5 CHECK CIRCUIT 3030 (DG/O) FOR SHORT TO GROUND</b> <ul style="list-style-type: none"> <li>With key OFF, measure the resistance between BOB pin 86 and ground (BOB pin 80).</li> <li>Is the resistance greater than 10,000 ohms?</li> </ul>	Yes = REPLACE the IAA module. REFER to <a href="#">Section 412-04</a> . No = REPAIR the DG/O wire.
<b>A6 CHECK CIRCUIT 3029 (DG/O) FOR OPEN</b> <ul style="list-style-type: none"> <li>Connect 104-Pin Breakout Box (BOB) to IAA module C1945; leave IAA module disconnected.</li> <li>With key OFF, measure the resistance of the DG/O wire between A/C pressure sensor C1994 and BOB pin 3.</li> <li>Is the resistance less than 5 ohms?</li> </ul>	Yes = GO to A7. No = REPAIR the DG/O wire.
<b>A7 CHECK CIRCUIT 3029 (DG/O) FOR SHORT TO GROUND</b> <ul style="list-style-type: none"> <li>With key OFF, measure the resistance between BOB pin 3 and ground (BOB pin 80).</li> <li>Is the resistance greater than 10,000 ohms?</li> </ul>	Yes = GO to A8. No = REPAIR the DG/O wire.
<b>A8 CHECK CIRCUIT 3029 (DG/O) FOR SHORT TO POWER</b> <ul style="list-style-type: none"> <li>With key ON, measure the voltage between BOB pin 3 and ground (BOB pin 80).</li> <li>Is the voltage greater than 0 volt?</li> </ul>	Yes = REPAIR the DG/O wire. No = REPLACE the A/C pressure sensor.

**PINPOINT TEST B: DTC B1946 A/C POST EVAPORATOR SENSOR CIRCUIT FAILURE**

<b>TEST STEP</b>	<b>ACTION TO TAKE</b>
<b>B1 CHECK EVAPORATOR TEMPERATURE</b> <ul style="list-style-type: none"> <li>With key ON, set the mode select knob to the A/C position, the temperature control knob to full cool position, and the blower control knob to HIGH speed position, and monitor the interface adapter assembly (IAA) module PID ACPEVAP.</li> <li>Is the temperature between -40°C (-40°F) and 215°C (419°F)?</li> </ul>	Yes = GO to B6. No = GO to B2.
<b>B2 IDENTIFY EVAPORATOR TEMPERATURE READING</b> <ul style="list-style-type: none"> <li>Is the temperature reading in test step B1 equal to 215°C (419°F)?</li> </ul>	Yes = GO to B3. No = GO to B5.
<b>B3 CHECK CIRCUITS 3051 (BK/W) AND 3063 (T/O) FOR OPEN(S)</b>	

(Continued)

**DIAGNOSIS AND TESTING (Continued)****PINPOINT TEST B: DTC B1946 A/C POST EVAPORATOR SENSOR CIRCUIT FAILURE**

<b>TEST STEP</b>	<b>ACTION TO TAKE</b>
<ul style="list-style-type: none"> <li>Connect 104-Pin Breakout Box (BOB) to IAA module C1945; leave IAA module disconnected.</li> <li>With key OFF, disconnect evaporator temperature sensor C1972 and measure the resistance of the BK/W wire between evaporator temperature sensor C1972 and BOB pin 102.</li> <li>With key OFF, measure the resistance of the T/O wire between evaporator temperature sensor C1972 and BOB pin 67.</li> <li><b>Are the resistances less than 5 ohms?</b></li> </ul>	Yes = GO to <b>B4</b> . No = REPAIR the wire(s) in question.
<b>B4 CHECK CIRCUIT 3063 (T/O) FOR SHORT TO POWER</b> <ul style="list-style-type: none"> <li>With key OFF, measure the voltage between BOB pin 67 and ground (BOB pin 80).</li> <li><b>Is the voltage greater than 0 volt?</b></li> </ul>	Yes = REPAIR the T/O wire. No = GO to <b>B7</b> .
<b>B5 CHECK CIRCUIT 3063 (T/O) FOR SHORT TO GROUND</b> <ul style="list-style-type: none"> <li>Connect 104-Pin Breakout Box (BOB) to IAA module C1945; leave IAA module disconnected.</li> <li>With key OFF, disconnect evaporator temperature sensor C1972 and measure the resistance between BOB pin 67 and ground (BOB pin 80).</li> <li><b>Is the resistance greater than 10,000 ohms?</b></li> </ul>	Yes = GO to <b>B7</b> . No = REPAIR the T/O wire.
<b>B6 CHECK EVAPORATOR TEMPERATURE READING FOR NORMAL A/C OPERATION</b> <ul style="list-style-type: none"> <li><b>Is the temperature reading in test step B1 between 0°C (32°F) and 10°C (50°F)?</b></li> </ul>	Yes = System OK. CHECK wiring for intermittent connections. No = GO to <b>B7</b> .
<b>B7 CHECK EVAPORATOR TEMPERATURE SENSOR</b> <ul style="list-style-type: none"> <li>With key OFF, disconnect evaporator temperature sensor C1972 and measure the resistance between the terminals of the evaporator temperature sensor and compare the reading to the values below:  <b>Actual Temperature (Approximate)</b> <ul style="list-style-type: none"> <li>—0 °C (32°F) = 1350-1650 ohms</li> <li>—10 °C (50°F) = 834-1020 ohms</li> <li>—15 °C (59°F) = 646-790 ohms</li> <li>—20 °C (68°F) = 531-649 ohms</li> <li>—25 °C (77°F) = 419-512 ohms</li> <li>—30 °C (86°F) = 348-425 ohms</li> <li>—35 °C (95°F) = 278-340 ohms</li> </ul> </li> <li><b>Is the resistance OK?</b></li> </ul>	Yes = REPLACE the IAA module. REFER to <a href="#">Section 412-04</a> . No = REPLACE the evaporator temperature sensor.

**PINPOINT TEST C: DTC B2119 COMPRESSOR FAILURE**

<b>TEST STEP</b>	<b>ACTION TO TAKE</b>
<b>C1 CHECK A/C SWITCHED POWER OUTPUT FROM A/C INVERTER MOTOR CONTROLLER (IMC) INTERLOCK</b> <ul style="list-style-type: none"> <li>With key OFF, disconnect A/C C1902.</li> <li>With key ON, set the mode select knob to the A/C position and measure the voltage between terminal A on the A/C IMC and ground.</li> <li><b>Is the voltage greater than 10 volts?</b></li> </ul>	Yes = GO to <b>C4</b> . No = GO to <b>C2</b> .
<b>C2 CHECK A/C SWITCHED POWER TO A/C IMC INTERLOCK</b> <ul style="list-style-type: none"> <li>With key OFF, disconnect A/C IMC C1947.</li> <li>With key ON, set the mode select knob to the A/C position and measure the voltage between pin 7 (P wire) on A/C IMC C1947 and ground.</li> <li><b>Is the voltage greater than 10 volts?</b></li> </ul>	Yes = REPLACE A/C IMC. No = GO to <b>C3</b> .

(Continued)

**DIAGNOSIS AND TESTING (Continued)****PINPOINT TEST C: DTC B2119 COMPRESSOR FAILURE**

TEST STEP	ACTION TO TAKE
<b>C3 CHECK CIRCUIT 3232 (P) FOR OPEN</b> <ul style="list-style-type: none"> <li>• Connect 104-Pin Breakout Box (BOB) to interface adapter assembly (IAA) module C1945; leave IAA module disconnected.</li> <li>• With key OFF, measure the resistance of the P wire between pin 7 on A/C IMC C1947 and BOB pin 36.</li> <li>• <b>Is the resistance less than 5 ohms?</b></li> </ul>	Yes = REPLACE IAA module. REFER to <a href="#">Section 412-04</a> . No = REPAIR the P wire.
<b>C4 CHECK A/C COMPRESSOR INTERLOCK CIRCUIT 3230 (Y) FOR OPEN</b> <ul style="list-style-type: none"> <li>• With key OFF, measure the resistance of the Y wire between pin A and pin F on A/C C1902.</li> <li>• <b>Is the resistance less than 5 ohms?</b></li> </ul>	Yes = GO to <b>C5</b> . No = REPLACE the A/C compressor.
<b>C5 CHECK A/C COMPRESSOR</b> <ul style="list-style-type: none"> <li>• With key OFF, measure the resistance between pin B (DG wire) and pin C (BK wire) on A/C C1902.</li> <li>• With key OFF, measure the resistance between pin B (DG wire) and pin D (W wire) on A/C C1902.</li> <li>• With key OFF, measure the resistance between pin C (BK wire) and pin D (W wire) on A/C C1902.</li> <li>• <b>Are the resistances less than 5 ohms?</b></li> </ul>	Yes = GO to <b>C6</b> . No = REPLACE the A/C compressor.
<b>C6 CHECK CIRCUITS 3025 (Y/LG) AND 3027 (R/W) FOR OPEN(S)</b> <ul style="list-style-type: none"> <li>• Connect 104-Pin Breakout Box (BOB) to interface adapter assembly (IAA) module C1945; leave IAA module disconnected.</li> <li>• With key OFF, disconnect A/C IMC C1947 and measure the resistance of the Y/LG wire between pin 5 on A/C IMC C1947 and BOB pin 78.</li> <li>• With key OFF, measure the resistance of the R/W wire between pin 9 on A/C IMC C1947 and BOB pin 40.</li> <li>• <b>Are the resistances less than 5 ohms?</b></li> </ul>	Yes = GO to <b>C7</b> . No = REPAIR the wire(s) in question.
<b>C7 CHECK CIRCUIT 3027 (R/W) FOR SHORT TO GROUND</b> <ul style="list-style-type: none"> <li>• With key OFF, measure the resistance between BOB pin 40 and ground (BOB pin 80).</li> <li>• <b>Is the resistance greater than 10,000 ohms?</b></li> </ul>	Yes = GO to <b>C8</b> . No = REPAIR the R/W wire.
<b>C8 CHECK A/C IMC GROUND REFERENCE</b> <ul style="list-style-type: none"> <li>• With key OFF, connect IAA module to BOB; leave BOB connected to IAA module C1945.</li> <li>• With key OFF, measure the resistance between BOB pin 78 and ground (BOB pin 80).</li> <li>• <b>Is the resistance less than 5 ohms?</b></li> </ul>	Yes = GO to <b>C9</b> . No = REPLACE the IAA module. REFER to <a href="#">Section 412-04</a> .
<b>C9 CHECK IAA MODULE</b> <ul style="list-style-type: none"> <li>• With key OFF, reconnect A/C C1902 and C1947.</li> <li>• With key ON, set the mode select knob to the A/C position, the temperature control knob to full cool position, and the blower control knob to HIGH speed position, and monitor IAA module PID C/M__SPD while connecting a jumper wire between BOB pins 40 and 80.</li> <li>• <b>Does the C/M__SPD PID indicate 0 rpm?</b></li> </ul>	Yes = GO to <b>C10</b> . No = REPLACE the IAA module. REFER to <a href="#">Section 412-04</a> .
<b>C10 CHECK A/C COMPRESSOR OPERATION</b> <ul style="list-style-type: none"> <li>• Remove the jumper wire and check the A/C compressor.</li> <li>• <b>Does the A/C compressor operate?</b></li> </ul>	Yes = System OK. CHECK wiring for intermittent connections. No = REPLACE the A/C IMC.

**DIAGNOSIS AND TESTING (Continued)****PINPOINT TEST D: DTC B2518 COMPRESSOR OVERTEMPERATURE FAULT**

TEST STEP	ACTION TO TAKE
<b>D1 CHECK FOR A/C TEMPERATURE SENSOR OUT OF RANGE FAULT</b> <ul style="list-style-type: none"> <li>• Check the interface adapter assembly (IAA) module for continuous diagnostic trouble codes (DTCs).</li> <li>• <b>Does DTC B2606 A/C Temperature Sensor Out of Range occur along with DTC B2518 Compressor Overtemperature Fault?</b></li> </ul>	Yes = GO to <a href="#">Pinpoint Test E</a> . No = GO to <b>D2</b> .
<b>D2 CHECK COMPRESSOR TEMPERATURE</b> <ul style="list-style-type: none"> <li>• With key ON, monitor IAA module PID AC_CTMP.</li> <li>• <b>Is the temperature greater than 77°C (171°F)?</b></li> </ul>	Yes = GO to <b>D3</b> . No = GO to <b>D4</b> .
<b>D3 CHECK COMPRESSOR TEMPERATURE AFTER COOLING</b> <ul style="list-style-type: none"> <li>• Open the hood and allow the underhood compartment to cool for one hour.</li> <li>• With key ON, monitor IAA module PID AC_CTMP.</li> <li>• <b>Is the temperature greater than 77°C (171°F)?</b></li> </ul>	Yes = GO to <b>D5</b> . No = GO to <b>D4</b> .
<b>D4 CHECK FOR COMPRESSOR OVERTEMPERATURE FAULT</b> <ul style="list-style-type: none"> <li>• Clear the continuous DTCs from the IAA module.</li> <li>• Operate the A/C system for five minutes and retrieve continuous DTCs from the IAA module.</li> <li>• <b>Does DTC B2518 Compressor Overtemperature Fault occur?</b></li> </ul>	Yes = GO to <b>D5</b> . No = System OK.
<b>D5 CHECK A/C OVERTEMPERATURE SENSOR</b> <ul style="list-style-type: none"> <li>• With key OFF, disconnect A/C overtemperature sensor C1995 and measure the resistance between the terminals of the A/C overtemperature sensor and compare the reading to the values below:  <b>Actual Temperature (Approximate)</b> <ul style="list-style-type: none"> <li>—0 °C (32°F) = 111,960-136,840 ohms</li> <li>—10 °C (50°F) = 77,040-94,160 ohms</li> <li>—15 °C (59°F) = 63,900-78,100 ohms</li> <li>—20 °C (68°F) = 53,010-64,790 ohms</li> <li>—25 °C (77°F) = 44,010-53,790 ohms</li> <li>—30 °C (86°F) = 36,540-44,660 ohms</li> <li>—35 °C (95°F) = 30,330-37,070 ohms</li> <li>—40 °C (104°F) = 25,110-30,690 ohms</li> <li>—45 °C (113°F) = 20,520-25,080 ohms</li> <li>—50 °C (122°F) = 17,100-20,900 ohms</li> <li>—55 °C (131°F) = 15,300-18,700 ohms</li> <li>—60 °C (140°F) = 11,880-14,520 ohms</li> <li>—65 °C (149°F) = 9,630-11,770 ohms</li> <li>—70 °C (158°F) = 8,010-9,790 ohms</li> <li>—75 °C (167°F) = 6,570-8,030 ohms</li> <li>—80 °C (176°F) = 5,580-6,820 ohms</li> <li>—85 °C (185°F) = 4,680-5,720 ohms</li> <li>—90 °C (194°F) = 3,780-4,620 ohms</li> <li>—95 °C (203°F) = 3,150-3,850 ohms</li> <li>—100 °C (212°F) = 2,610-3,190 ohms</li> </ul> </li> <li>• <b>Is the resistance OK?</b></li> </ul>	Yes = REPLACE the IAA module. REFER to <a href="#">Section 412-04</a> . No = REPLACE the A/C compressor.

**DIAGNOSIS AND TESTING (Continued)****PINPOINT TEST E: DTC B2606 A/C TEMPERATURE SENSOR OUT OF RANGE**

TEST STEP	ACTION TO TAKE
<b>E1 CHECK FOR COMPRESSOR OVERTEMPERATURE FAULT</b> <ul style="list-style-type: none"> <li>Check the interface adapter assembly (IAA) module for continuous diagnostic trouble codes (DTCs).</li> <li><b>Does DTC B2518 Compressor Overtemperature Fault occur along with DTC B2606 A/C Temperature Sensor Out of Range?</b></li> </ul>	Yes = GO to <b>E2</b> . No = GO to <b>E3</b> .
<b>E2 CHECK CIRCUIT 3220 (PK) FOR SHORT TO GROUND</b> <ul style="list-style-type: none"> <li>Connect 104-Pin Breakout Box (BOB) to IAA module C1945; leave IAA module disconnected.</li> <li>With key OFF, disconnect A/C overtemperature sensor C1995 and measure the resistance between BOB pin 47 and ground (BOB pin 80).</li> <li><b>Is the resistance greater than 10,000 ohms?</b></li> </ul>	Yes = GO to <b>E5</b> . No = REPAIR the PK wire.
<b>E3 CHECK COMPRESSOR TEMPERATURE</b> <ul style="list-style-type: none"> <li>With key ON, monitor IAA module PID AC_CTMP.</li> <li><b>Is the temperature equal to 215°C (419°F)?</b></li> </ul>	Yes = GO to <b>E4</b> . No = GO to <b>E5</b> .
<b>E4 CHECK CIRCUITS 3220 (PK) AND 3221 (BR/LB) FOR OPEN(S)</b> <ul style="list-style-type: none"> <li>Connect 104-Pin Breakout Box (BOB) to IAA module C1945; leave IAA module disconnected.</li> <li>With key OFF, disconnect A/C overtemperature sensor C1995 and measure the resistance of the PK wire between A/C overtemperature sensor C1995 and BOB pin 47.</li> <li>With key OFF, measure the resistance of the BR/LB wire between A/C overtemperature sensor C1995 and BOB pin 57.</li> <li><b>Are the resistances less than 5 ohms?</b></li> </ul>	Yes = GO to <b>E5</b> . No = REPAIR the wire(s) in question.
<b>E5 CHECK A/C OVERTEMPERATURE SENSOR</b> <ul style="list-style-type: none"> <li>With key OFF, disconnect A/C overtemperature sensor C1995 and measure the resistance between the terminals of the A/C overtemperature sensor and compare the reading to the values below:  <b>Actual Temperature (Approximate)</b> <ul style="list-style-type: none"> <li>—0 °C (32°F) = 111,960-136,840 ohms</li> <li>—10 °C (50°F) = 77,040-94,160 ohms</li> <li>—15 °C (59°F) = 63,900-78,100 ohms</li> <li>—20 °C (68°F) = 53,010-64,790 ohms</li> <li>—25 °C (77°F) = 44,010-53,790 ohms</li> <li>—30 °C (86°F) = 36,540-44,660 ohms</li> <li>—35 °C (95°F) = 30,330-37,070 ohms</li> <li>—40 °C (104°F) = 25,110-30,690 ohms</li> <li>—45 °C (113°F) = 20,520-25,080 ohms</li> <li>—50 °C (122°F) = 17,100-20,900 ohms</li> <li>—55 °C (131°F) = 15,300-18,700 ohms</li> <li>—60 °C (140°F) = 11,880-14,520 ohms</li> <li>—65 °C (149°F) = 9,630-11,770 ohms</li> <li>—70 °C (158°F) = 8,010-9,790 ohms</li> <li>—75 °C (167°F) = 6,570-8,030 ohms</li> <li>—80 °C (176°F) = 5,580-6,820 ohms</li> <li>—85 °C (185°F) = 4,680-5,720 ohms</li> <li>—90 °C (194°F) = 3,780-4,620 ohms</li> <li>—95 °C (203°F) = 3,150-3,850 ohms</li> <li>—100 °C (212°F) = 2,610-3,190 ohms</li> </ul> </li> <li><b>Is the resistance OK?</b></li> </ul>	Yes = REPLACE the IAA module. REFER to <a href="#">Section 412-04</a> . No = REPLACE the A/C compressor.

**DIAGNOSIS AND TESTING (Continued)****PINPOINT TEST F: A/C COMPRESSOR DOES NOT OPERATE (NO COOLING)**

TEST STEP	ACTION TO TAKE
<b>F1 CHECK A/C LOW PRESSURE SWITCH</b> <ul style="list-style-type: none"> <li>With key OFF, disconnect A/C low pressure switch C1973 and connect a jumper wire between the P wire and PK/LB wire on A/C low pressure switch C1973.</li> <li>With key ON, set the mode select knob to the A/C position, the temperature control knob to full cool position, and the blower control knob to HIGH speed position.</li> <li><b>Does the A/C compressor operate?</b></li> </ul>	Yes = GO to <b>F2</b> .  No = GO to <b>F3</b> .
<b>F2 CHECK A/C SYSTEM PRESSURE</b> <ul style="list-style-type: none"> <li>Connect R-134a Manifold Gauge Set to charge ports and observe the A/C system pressure (with jumper wire still connected to A/C low pressure switch C1973).</li> <li><b>Is the pressure above 345 kPa (50 psi)?</b></li> </ul>	Yes = REPLACE the A/C low pressure switch.  No = CHECK refrigerant system for leaks. REPAIR as necessary. RECHARGE the A/C system.
<b>F3 CHECK A/C LOW PRESSURE SWITCH STATUS</b> <ul style="list-style-type: none"> <li>With key OFF, remove jumper wire and reconnect A/C low pressure switch C1973.</li> <li>With key ON, set the mode select knob to the A/C position and monitor the interface adapter assembly (IAA) module PID AC__LOWP.</li> <li><b>Does the AC__LOWP PID indicate DISABLE?</b></li> </ul>	Yes = GO to <b>F7</b> .  No = GO to <b>F4</b> .
<b>F4 CHECK A/C LOW PRESSURE SWITCH SIGNAL (12-VOLT POWER) TO INTERFACE ADAPTER ASSEMBLY (IAA) MODULE</b> <ul style="list-style-type: none"> <li>Connect the 104-Pin Breakout Box (BOB) to the IAA module and IAA module C1945.</li> <li>With key ON, set the mode select knob to the A/C position and measure the voltage between BOB pin 56 and ground (BOB pin 80).</li> <li><b>Is the voltage greater than 10 volts?</b></li> </ul>	Yes = REPLACE the IAA module. REFER to <a href="#">Section 412-04</a> .  No = GO to <b>F5</b> .
<b>F5 CHECK A/C SWITCHED POWER (12 VOLT) TO A/C LOW PRESSURE SWITCH</b> <ul style="list-style-type: none"> <li>With key OFF, disconnect A/C low pressure switch C1973.</li> <li>With key ON, set the mode select knob to the A/C position and measure the voltage between the P wire on A/C low pressure switch C1973 and ground.</li> <li><b>Is the voltage greater than 10 volts?</b></li> </ul>	Yes = REPAIR the PK/LB wire between A/C low pressure switch C1973 and IAA module C1945.  No = GO to <b>F6</b> .
<b>F6 CHECK CIRCUIT 3232 (P) FOR OPEN</b> <ul style="list-style-type: none"> <li>With key OFF, measure the resistance of the P wire between A/C low pressure switch C1973 and BOB pin 36.</li> <li><b>Is the resistance less than 5 ohms?</b></li> </ul>	Yes = REPLACE the IAA module. REFER to <a href="#">Section 412-04</a> .  No = REPAIR the P wire.
<b>F7 CHECK A/C COMPRESSOR PWM OUTPUT SIGNAL FROM INTERFACE ADAPTER ASSEMBLY (IAA) MODULE</b> <ul style="list-style-type: none"> <li>Connect the 104-Pin Breakout Box (BOB) to the IAA module and IAA module C1945.</li> <li>With key ON, set the mode select knob to the A/C position, the temperature control knob to the full cool position, and measure the frequency between BOB pin 46 and ground (BOB pin 80).</li> <li><b>Is the frequency between 45 and 120 Hz?</b></li> </ul>	Yes = GO to <b>F9</b> .  No = GO to <b>F8</b> .
<b>F8 CHECK CIRCUIT 3026 (R/PK) FOR SHORT TO GROUND</b>	

(Continued)

**DIAGNOSIS AND TESTING (Continued)****PINPOINT TEST F: A/C COMPRESSOR DOES NOT OPERATE (NO COOLING)**

TEST STEP	ACTION TO TAKE
<ul style="list-style-type: none"> <li>• With key OFF, disconnect IAA module from BOB; leave BOB connected to IAA module C1945.</li> <li>• With key OFF, disconnect A/C inverter motor controller (IMC) C1947 and measure the resistance between BOB pin 46 and ground (BOB pin 80).</li> <li>• <b>Is the resistance greater than 10,000 ohms?</b></li> </ul>	Yes = REPLACE the IAA module. REFER to <a href="#">Section 412-04</a> . No = REPAIR the R/PK wire.
<b>F9 CHECK CIRCUIT 3026 (R/PK) FOR OPEN</b> <ul style="list-style-type: none"> <li>• With key OFF, disconnect A/C inverter motor controller (IMC) C1947 and measure the resistance of the R/PK wire between pin 8 on A/C IMC C1947 and BOB pin 46.</li> <li>• <b>Is the resistance less than 5 ohms?</b></li> </ul>	Yes = GO to <b>F10</b> . No = REPAIR the R/PK wire.
<b>F10 CHECK HIGH-VOLTAGE POWER TO A/C IMC</b> <ul style="list-style-type: none"> <li>• Disconnect the 12-volt auxiliary battery negative cable.</li> <li>• Remove the high-voltage power distribution box (HVPDB) cover.</li> </ul> <p><b>⚠ WARNING: The following test steps contain high-voltage procedures. High-voltage insulated safety gloves and face shield must be worn when performing the following steps. Failure to follow this warning may result in severe personal injury or death.</b></p> <ul style="list-style-type: none"> <li>• Disconnect HVPDB A/C IMC high-voltage C1917F.</li> <li>• Reinstall the HVPDB cover.</li> <li>• Reconnect the 12-volt auxiliary battery negative cable.</li> <li>• With key ON, measure the voltage between circuit 3150 (DB wire) and circuit 3151 (W wire) on HVPDB A/C IMC high-voltage C1917.</li> <li>• <b>Is the voltage greater than 300 volts?</b></li> </ul>	Yes = REPLACE the A/C IMC. No = GO to <b>F11</b> .
<b>F11 CHECK HIGH-VOLTAGE FUSE</b> <ul style="list-style-type: none"> <li>• With key OFF, disconnect the 12-volt auxiliary battery negative cable.</li> <li>• Disconnect high-voltage auxiliary load in-line C1935 on the traction battery support tray.</li> <li>• Disconnect all HVPDB high-voltage connectors.</li> <li>• Disconnect power steering assembly high-voltage C1895.</li> <li>• Measure the resistance of the 25A A/C fuse.</li> <li>• <b>Is the resistance greater than 1,000 ohms?</b></li> </ul>	Yes = REPLACE the 25A A/C fuse. GO to <b>F12</b> . No = REPLACE the HVPDB. REFER to <a href="#">Section 414-03A</a> or <a href="#">Section 414-03B</a> .
<b>F12 CHECK A/C IMC FOR SHORT</b> <ul style="list-style-type: none"> <li>• Connect the Capacitor Discharge Tool to the digital volt/ohmmeter (DVOM) and set the DVOM to volts.</li> <li>• Connect the probes of the Capacitor Discharge Tool to circuit 3150 (DB wire) and circuit 3151 (W wire) on HVPDB A/C IMC C1917M and allow the voltage on the DVOM to discharge to 0 volt.</li> <li>• Measure the resistance between circuit 3150 (DB wire) and circuit 3151 (W wire) on HVPDB A/C IMC C1917M.</li> <li>• <b>Is the resistance less than 30 ohms?</b></li> </ul>	Yes = REPLACE the A/C IMC. No = GO to <b>F13</b> .
<b>F13 CHECK HVPDB FOR SHORT</b> <ul style="list-style-type: none"> <li>• Measure the resistance between circuit 3150 (DB wire) and circuit 3151 (W wire) on HVPDB A/C IMC high-voltage C1917F.</li> <li>• <b>Is the resistance greater than 10,000 ohms?</b></li> </ul>	Yes = GO to <b>F14</b> . No = REPLACE the HVPDB. REFER to <a href="#">Section 414-03A</a> or <a href="#">Section 414-03B</a> .
<b>F14 CHECK SYSTEM</b>	

(Continued)

**DIAGNOSIS AND TESTING (Continued)****PINPOINT TEST F: A/C COMPRESSOR DOES NOT OPERATE (NO COOLING)**

TEST STEP	ACTION TO TAKE
<ul style="list-style-type: none"> <li>• With key OFF, reconnect A/C IMC C1947 and HVPDB A/C IMC high-voltage C1917.</li> <li>• With key ON, set the mode select knob to the A/C position, the temperature control knob to full cool position, and the blower control knob to HIGH speed position.</li> <li>• <b>Does the 25A A/C high-voltage fuse fail again?</b></li> </ul>	<p>Yes = REPLACE the A/C IMC. REPLACE the 25A A/C fuse. REFER to <a href="#">Section 414-03A</a> or <a href="#">Section 414-03B</a>.</p> <p>No = System OK.</p>

**REMOVAL AND INSTALLATION****A/C Compressor****Removal**

1. Disconnect the traction battery auxiliary load high-voltage connector. Refer to [Section 100-05](#).
2. Evacuate the A/C system. For additional information, refer to **Section 412-00 of the 2001 Ranger Workshop Manual**.
3. Remove the electric cooling fan.
  - 1 Release the coolant hose from the clips.
  - 2 Remove the bolts.
  - 3 Disconnect the electrical connector.
  - 4 Remove the fan.

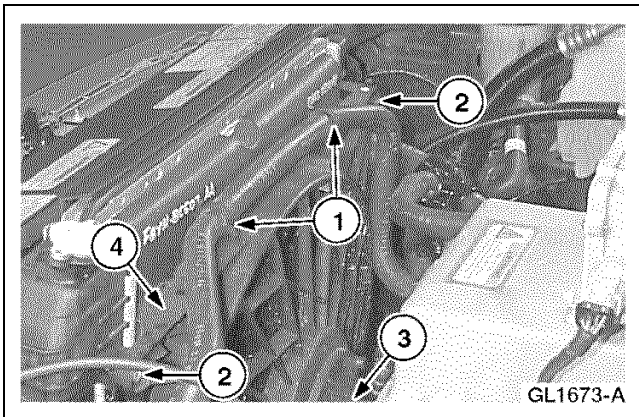

4. Raise and support the vehicle. For additional information, refer to [Section 100-02](#).



## REMOVAL AND INSTALLATION (Continued)

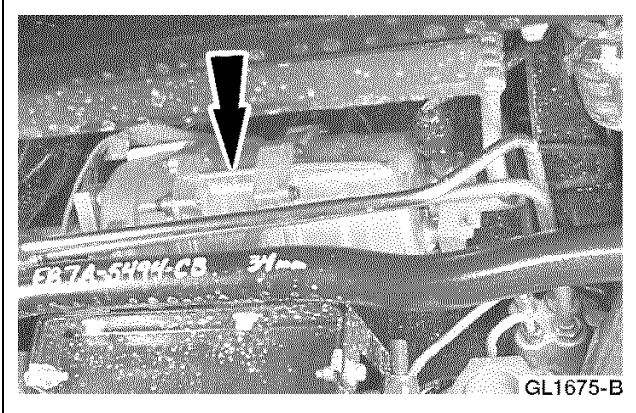

5. **NOTE:** The low-voltage electrical connector is shown, the high-voltage electrical connector is behind the A/C compressor.

Disconnect the low and the high-voltage electrical connectors at the A/C compressor.

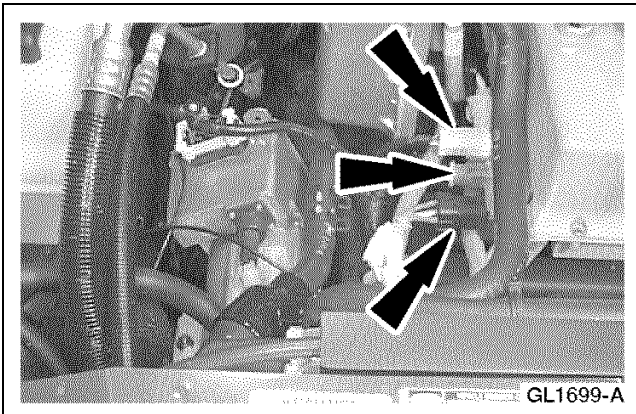

6. Disconnect the traction battery charger electrical connectors.

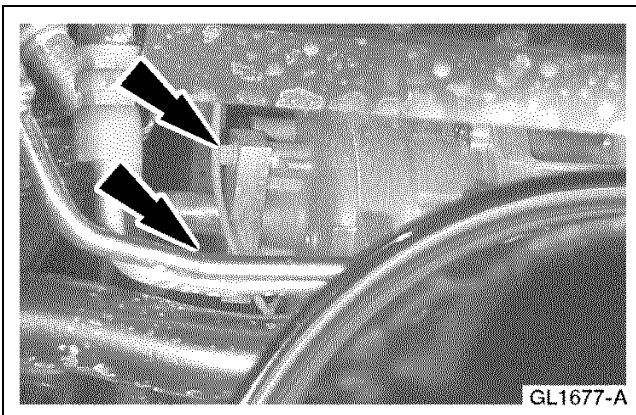

7. Remove the low side A/C line bolts.

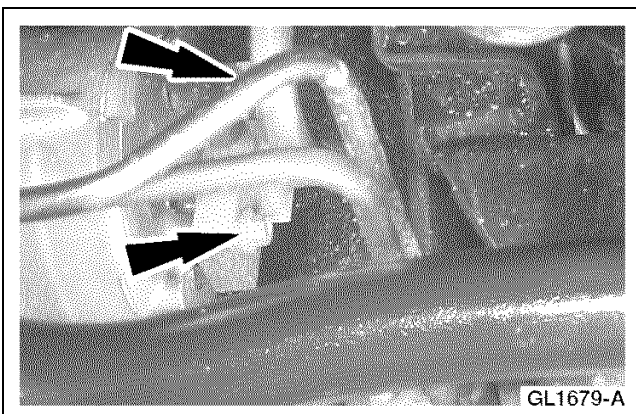

8. Remove the high side A/C line bolts.

## REMOVAL AND INSTALLATION (Continued)

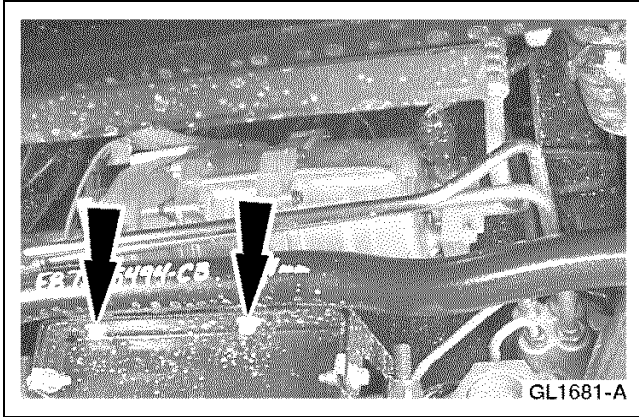

9. **NOTE:** If the isometric bracket for the compressor is excessively deteriorated, replace it during compressor removal and installation.
- Remove the four A/C compressor bolts.

10. Lower the vehicle.

11. Remove the A/C compressor.

- Carefully feed the compressor electrical wire down with the compressor.

### Installation

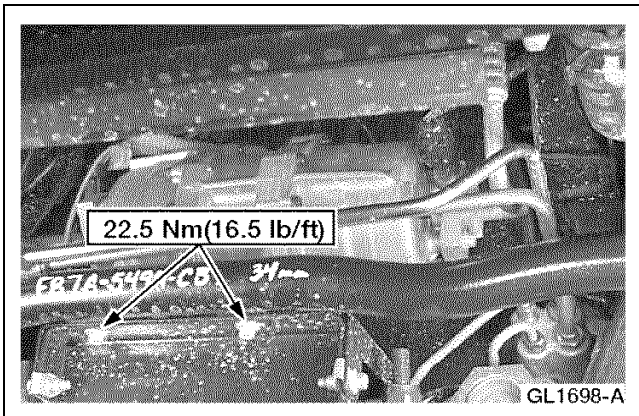

1. **⚠ CAUTION: The compressor uses Polyolester oil meeting Ford specification WSS-M2C31-B. This oil is not compatible with any other A/C oil.**

If the service compressor has no warning tag/label, then it has a full production (system) charge of oil (170 cc) and the following steps must be followed.

- Flush the A/C system to remove all existing oil.
- Replace the accumulator.
- Install the compressor.

2. If the service compressor has a warning tag/label, then it has no oil charge and 30 cc of Polyolester oil meeting Ford specification WSS-M2C31-B must be added to the system after compressor installation.

3. **⚠ CAUTION: Do not add any leak detection dye to the A/C system.**

To install, reverse the removal procedure.

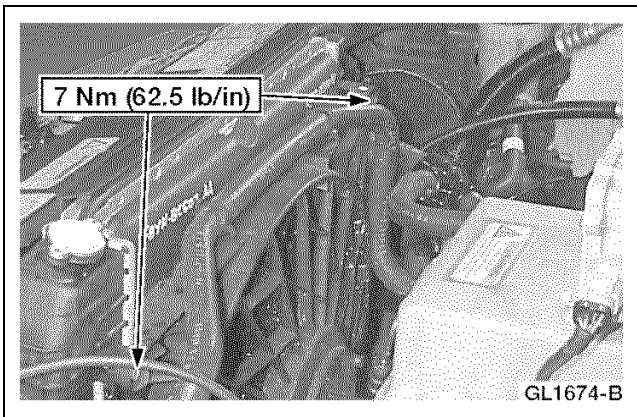
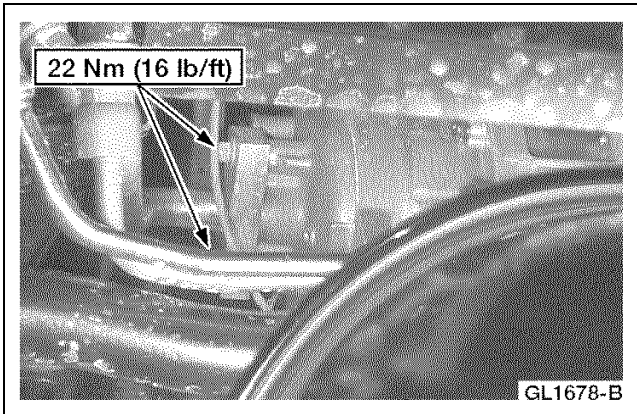
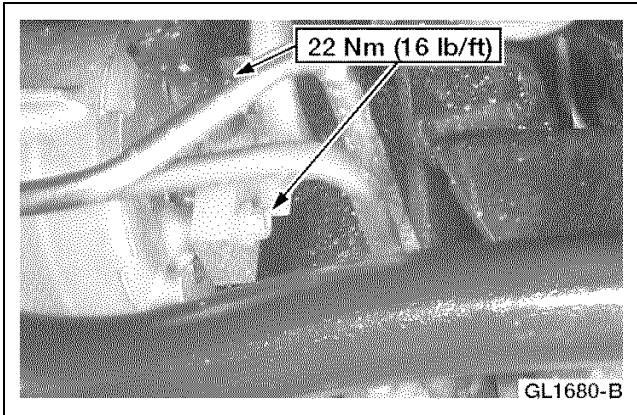
**REMOVAL AND INSTALLATION (Continued)****A/C Inverter Motor Controller****Removal**

1. Disconnect the traction battery auxiliary load high-voltage connector. Refer to [Section 100-05](#).

## REMOVAL AND INSTALLATION (Continued)

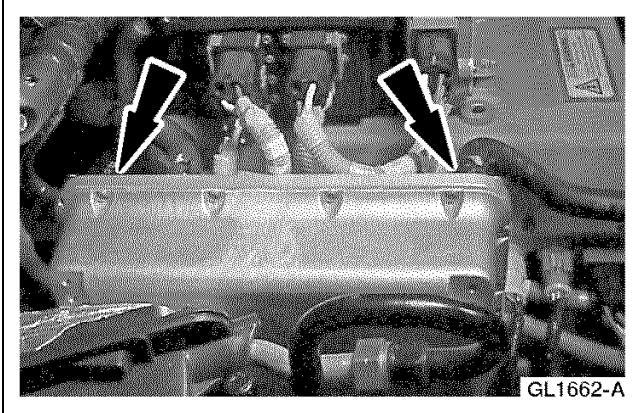

2. Clamp off and disconnect the coolant hoses.

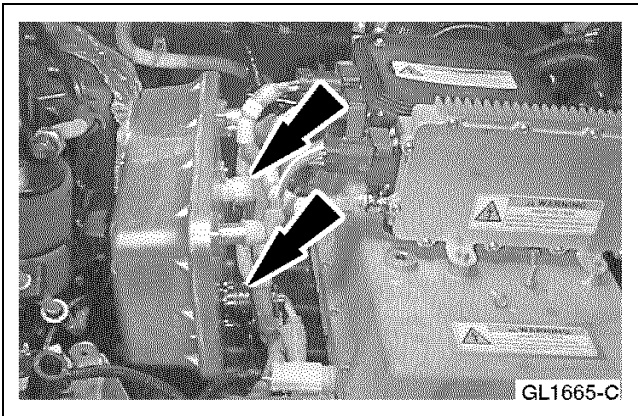

3. Disconnect the two A/C inverter motor controller (IMC) electrical connectors.
  - One on HVPDB —upper rear.
  - One on A/C IMC.

4. Raise and support the vehicle. Refer to [Section 100-02](#).

5. Disconnect the IMC electrical connector on the A/C compressor.

6. Lower the vehicle.

7. Remove the three A/C IMC bolts.
  - One —front, lower.
  - One —rear, lower.
  - One —rear, upper.

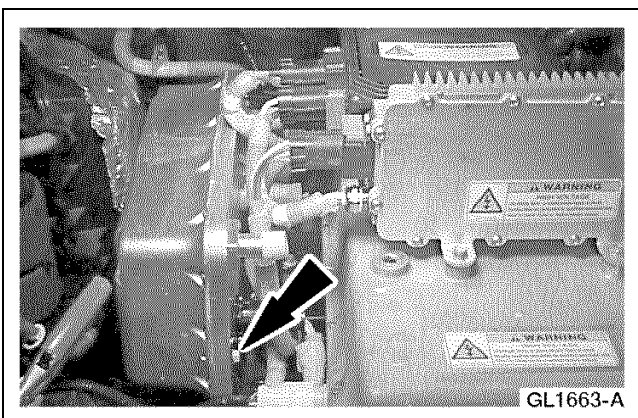

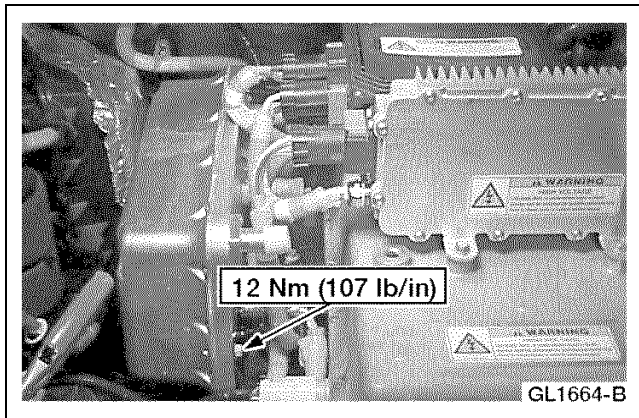
**REMOVAL AND INSTALLATION (Continued)****Installation**

1. To install, reverse the removal procedure.
  - After installation, bleed the cooling system. For additional information, refer to [Section 303-03](#).

---

[Manual Table of Contents](#)

## SECTION 412-04 Control Components

VEHICLE APPLICATION: Ranger EV

CONTENTS	PAGE
<b>SPECIFICATIONS</b> .....	<a href="#">412-04-2</a>
<b>DESCRIPTION AND OPERATION</b>	
Control Components .....	<a href="#">412-04-2</a>
<b>REMOVAL AND INSTALLATION</b>	
Interface Adapter Assembly (IAA) Module .....	<a href="#">412-04-2</a>
Positive Temperature Coefficient (PTC) Switching Module.....	<a href="#">412-04-4</a>
Variable Blower Controller (VBC).....	<a href="#">412-04-5</a>

## SPECIFICATIONS

### Torque Specifications

Description	Nm	Lb/In
Auxiliary battery ground cable nut	6	53
Harness clamp nut	7	62.5
High voltage power distribution box cover screws	2	18

(Continued)

### Torque Specifications

Description	Nm	Lb/In
IAA electrical connector bolt	6	53.5
IAA mounting nuts	9	80
PTC module bolts	12	107
VBC screws	1.5	13

## DESCRIPTION AND OPERATION

### Control Components

**NOTE:** Electric Ranger shown, Postal Ranger EV similar.

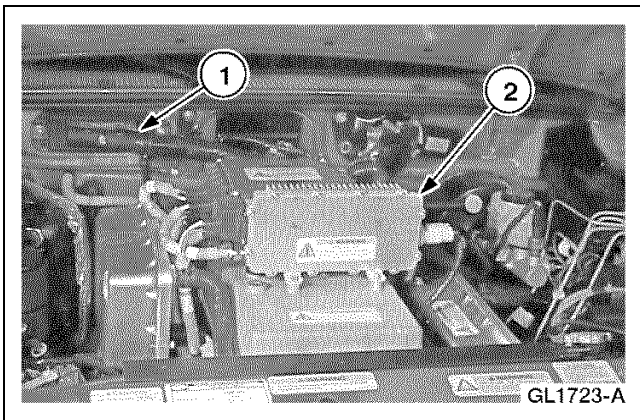

Item	Description
1	Interface Adapter Assembly (IAA)
2	Positive Temperature Coefficient (PTC) Module

The interface adapter assembly (IAA) module is a low voltage multi-function module that manages the following functions:

- instrument cluster functions
- power steering pump operation
- climate control system
- high voltage to low voltage conversion
- vacuum pump operation

The IAA module communicates with the traction inverter module (TIM) and the battery controller module (BCM) to support the instrument cluster operation and to determine when to close the high voltage auxiliary contactor.

The positive temperature coefficient (PTC) switching module provides high voltage to the PTC heater. Driver demands for heat are received by the IAA module, which commands the PTC switching module to operate the PTC heater. The PTC switching module can vary output to operate the PTC heater at either a low or high setting.

## REMOVAL AND INSTALLATION

### Interface Adapter Assembly (IAA) Module

#### Removal

**NOTE:** Electric Ranger shown, Postal Ranger EV similar.

1. Verify that the vehicle is turned off and is not being charged.

## REMOVAL AND INSTALLATION (Continued)

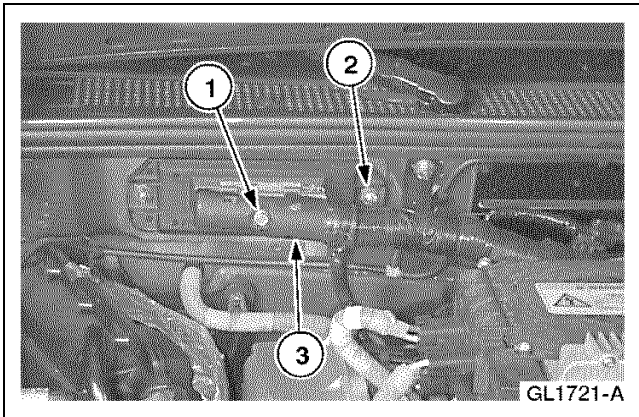

2. Disconnect the auxiliary battery ground cable.
3. Disconnect the interface adapter assembly (IAA) module electrical connector.
  - 1 Loosen the connector bolt.
  - 2 Remove the harness bracket nut.
  - 3 Disconnect the connector.

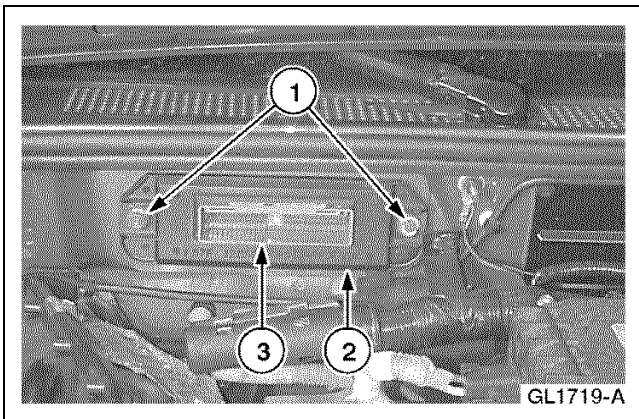

4. Remove the IAA module.
  - 1 Remove the nuts.
  - 2 Remove the mounting plate.
  - 3 Remove the IAA module.

## Installation

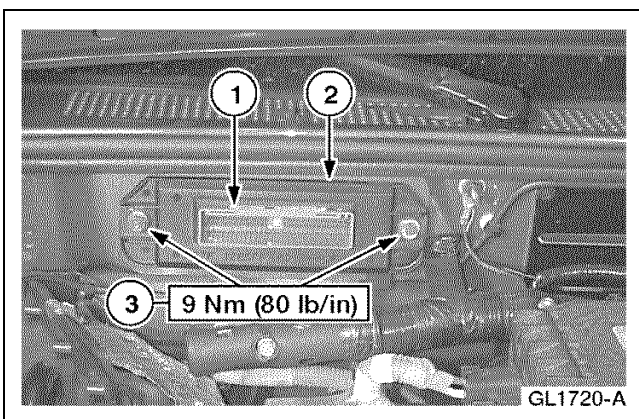

1. Install the IAA module.
  - 1 Install the IAA module.
  - 2 Position the mounting plate.
  - 3 Install the nuts.



## REMOVAL AND INSTALLATION (Continued)

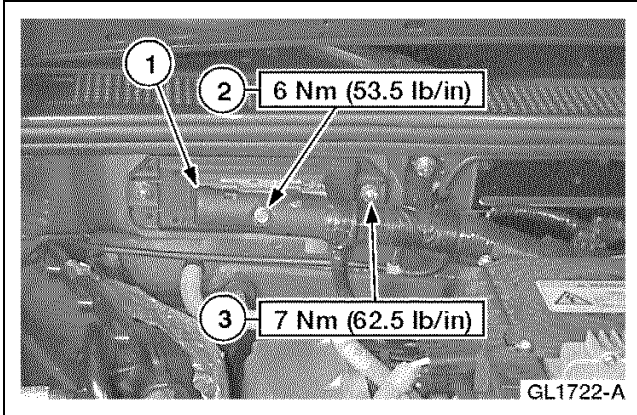

2. Connect the IAA module electrical connector.
  - 1 Connect the electrical connector.
  - 2 Tighten the connector bolt.
  - 3 Install the harness clamp nut.

3. Connect the auxiliary battery ground cable.

## Positive Temperature Coefficient (PTC) Switching Module

### Removal

**NOTE:** Electric Ranger shown, Postal Ranger EV similar.

1. Verify that the vehicle is turned off and is not being charged.
2. Disconnect the auxiliary battery ground cable.
3. Remove the high voltage power distribution box (HVPDB) cover.
  - 1 Remove the screws.
  - 2 Remove the cover.

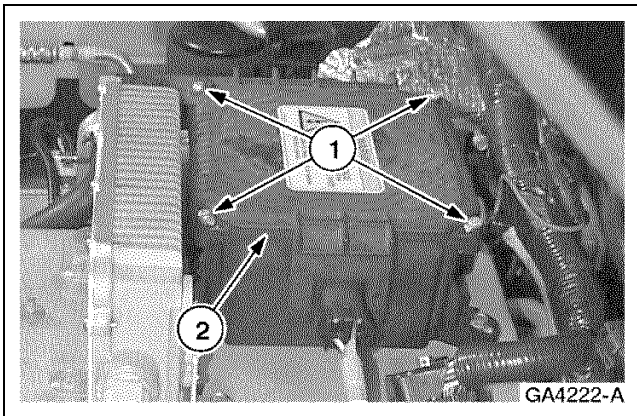

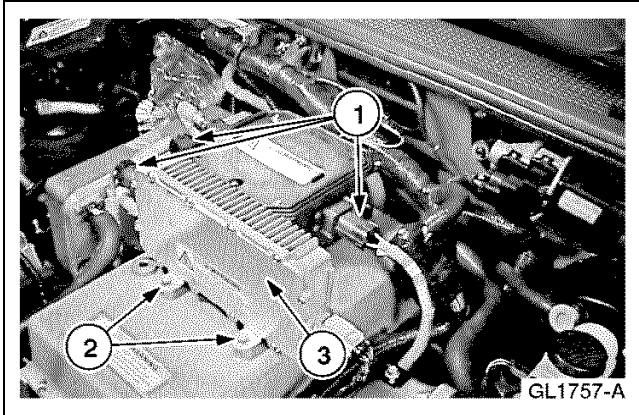
**REMOVAL AND INSTALLATION (Continued)**

4. Remove the positive temperature coefficient (PTC) switching module.
  - 1 Disconnect the electrical connectors.
  - 2 Remove the bolts.
  - 3 Remove the module.

**Installation**

1. To install, reverse the removal procedure.

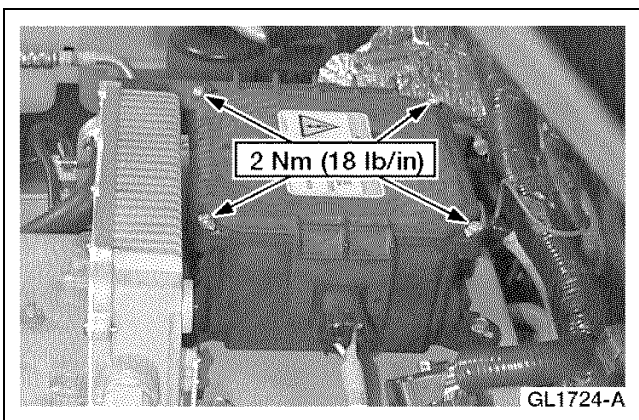
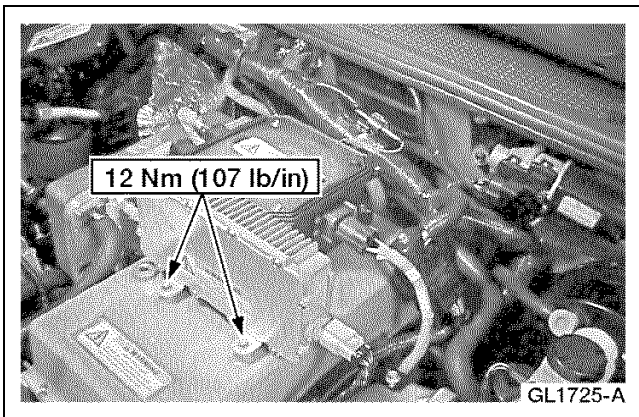
**Variable Blower Controller (VBC)****Removal and Installation**

1. Verify that the vehicle is turned off and is not being charged.

**REMOVAL AND INSTALLATION (Continued)**

2. Disconnect the auxiliary battery ground cable.
3. Disconnect the Variable Blower Controller (VBC) electrical connector.

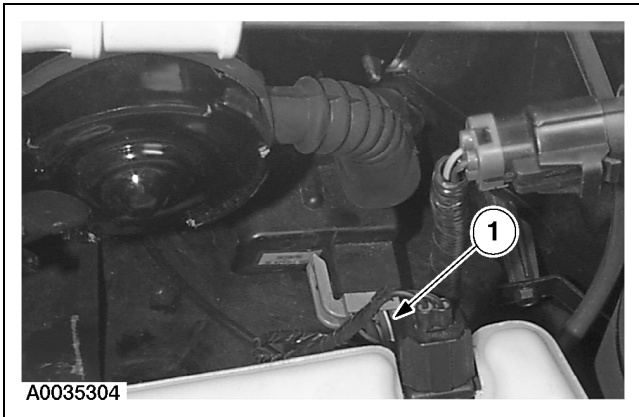

4. Remove the VBC.
  - 1 Remove the mounting screws.

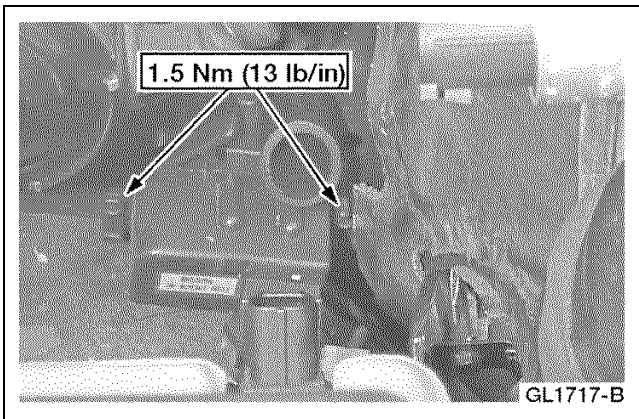

5. To install, reverse the removal procedure.

---

 Manual Table of Contents

## SECTION 413-01 Instrument Cluster

VEHICLE APPLICATION: Ranger EV

CONTENTS	PAGE
<b>DESCRIPTION AND OPERATION</b>	
Gauges and Warning Lamps .....	413-01-2
Indicator Bulbs .....	413-01-6
<b>DIAGNOSIS AND TESTING</b>	
Instrument Cluster .....	413-01-7
Electrical Schematic .....	413-01-7
Inspection and Verification .....	413-01-7
Pinpoint Tests .....	413-01-11
Symptom Chart .....	413-01-8
<b>REMOVAL AND INSTALLATION</b>	
Instrument Cluster —Postal Ranger EV .....	413-01-35

## DESCRIPTION AND OPERATION

### Gauges and Warning Lamps

The instrument cluster for the Electric Ranger contains specific and unique gauges for the vehicle. The cluster is mounted in the same position as the gasoline-powered vehicle, but the clusters are not interchangeable. A list of all the Electric Ranger specific gauges and warning indicators is included in this section.

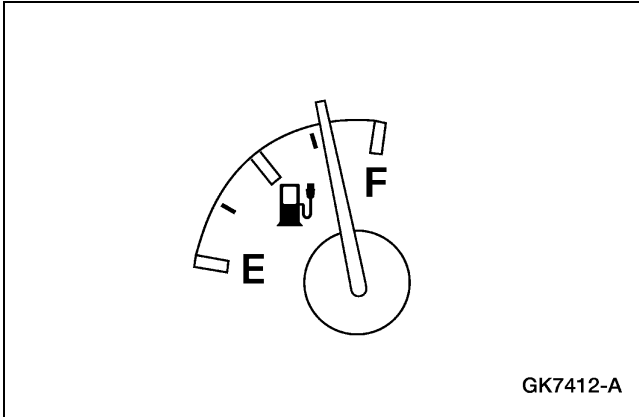

The traction battery state of charge (SOC) gauge is the equivalent of a fuel gauge on a gasoline-powered vehicle. F (full) indicates that the traction battery is completely charged, and E (empty) indicates that the traction battery has been discharged and requires recharging. When the gauge reads E, the traction battery is discharged to the point where further vehicle usage will shorten the traction battery service life. The battery control module (BCM) calculates the SOC and transmits the data to the interface adapter assembly (IAA) module through the standard corporate protocol (SCP) network.

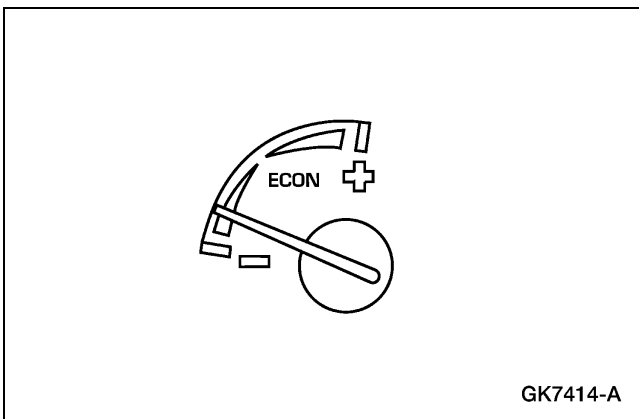

The economy gauge indicates current vehicle energy usage. Rapid acceleration and heavy use of vehicle accessories will cause the gauge to read towards the - (minus) side. Conservative operation will be indicated by a gauge reading towards the + (plus) side of the gauge. Operating the vehicle in the E (Economy) mode will cause the gauge to read toward the + side, as will limiting usage of the vehicle's accessories and avoiding heavy acceleration. The traction inverter module (TIM) computes economy and transmits the information through the SCP to the IAA module.

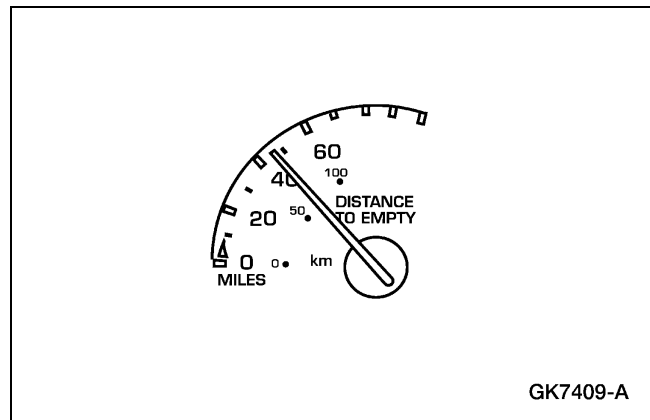

The distance to empty (DTE) gauge displays the approximate distance the vehicle can travel on the remaining traction battery charge. The gauge's reading is based upon remaining traction battery charge, driving conditions, and current vehicle usage. The BCM calculates the DTE and transmits this data to the IAA module for display on the gauge. The gauge will rise and fall as driving conditions change.

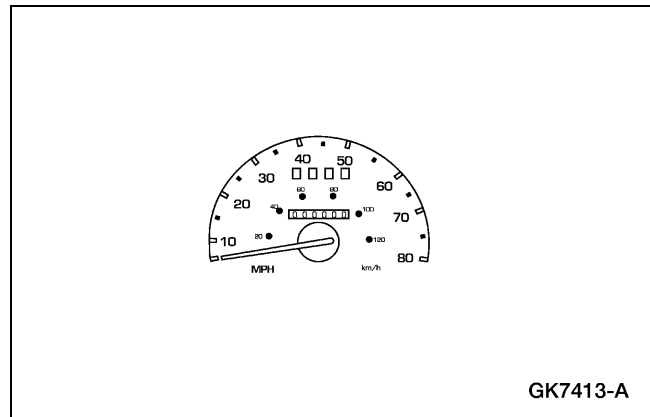

**DESCRIPTION AND OPERATION (Continued)**

The speedometer indicates the vehicle's speed in both miles per hour (mph) and kilometers per hour (km/h). The speedometer is driven by the traction inverter module (TIM), which uses two relative position sensors in the motor to calculate vehicle speed.

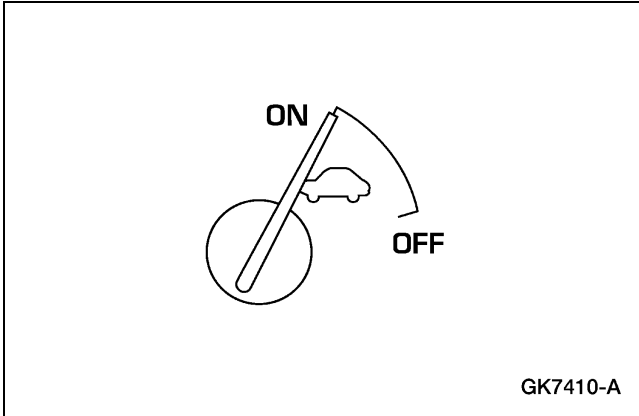

The motor enabled gauge indicates that the vehicle is turned on and is ready to drive. Turning the ignition to the START position and releasing it will turn the vehicle on, and the gauge will move to the ON position. The IAA module operates this gauge based upon SCP data received from the TIM.

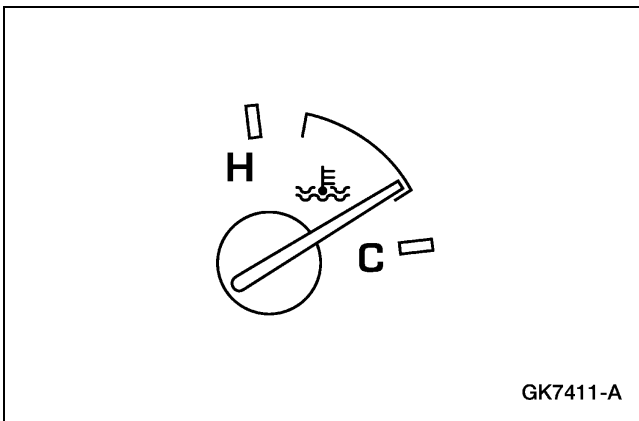

The temperature gauge is controlled by the IAA module. The gauge indicates to the operator the relative temperature of the powertrain, which includes the traction battery, TIM, motor/transaxle, and the coolant. The coolant temperature is determined based upon a signal from the coolant temperature sensor. All other temperature information is received through the SCP network. If the gauge reading is in the normal or hot region, it will display the warmest relative temperature of the TIM, motor/transaxle, traction battery, or the coolant system. If the gauge is in the cold region, the traction battery is cold enough to limit power output.

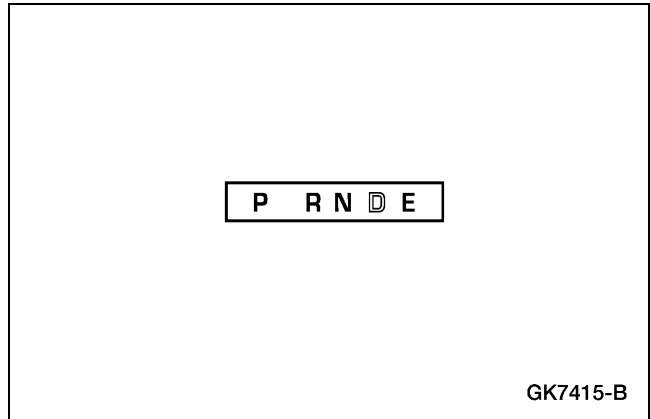

The gear selector indicates in which gear the vehicle is. The positions include P (Park), R (Reverse), N (Neutral), D (Drive), and E (Economy).

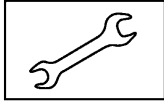
**DESCRIPTION AND OPERATION (Continued)**

GK7399-B

The malfunction indicator lamp (MIL) will illuminate when a diagnostic trouble code (DTC) has been set in either the IAA module, BCM, or the TIM. The IAA module has two special DTCs to indicate that the BCM or TIM requested the MIL to illuminate.



GK7400-A

The brake warning indicator will illuminate if the TIM detects a problem with the regenerative braking system, if there is low fluid level in the master cylinder, or if the parking brake is engaged.

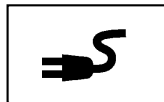

GK7402-A

The charge indicator illuminates when the key is turned to the RUN or START position while the vehicle is connected to the power control station (PCS). If the lamp flashes when the key is in the RUN position, the BCM has detected a vehicle malfunction and the traction battery cannot be charged.

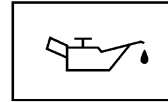

GK7405-A

The low oil pressure indicator is illuminated by the IAA module when the TIM senses that there is a low oil pressure condition in the motor/transaxle.

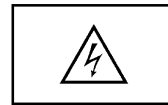

GK7404-A

**DESCRIPTION AND OPERATION (Continued)**

The electrical hazard warning indicator (LED) will illuminate if the BCM detects current leakage, or if one of the high-voltage interlocks in the traction bus or the auxiliary high-voltage bus is open. The electrical hazard warning indicator will also flash and the malfunction indicator lamp (MIL) will illuminate if the BCM detects an improperly closed or welded negative contactor. The LED is the same one used for the theft indicator in the standard 2001 Ranger.

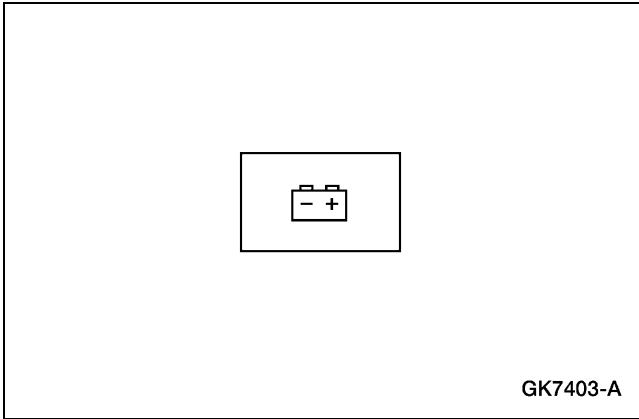

The auxiliary battery indicator indicates an auxiliary battery charging malfunction. The indicator will illuminate when auxiliary battery voltage drops below 11.5 volts or rises above 15.75 volts until the IAA module enters either its over-voltage or under-voltage protection mode.

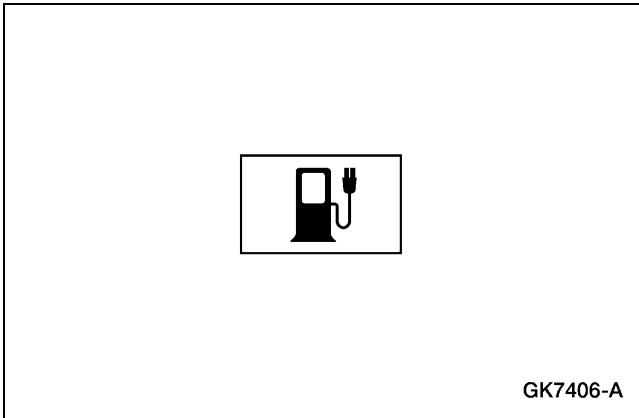

The low state of charge (SOC) indicator indicates that the traction battery has a 10% remaining SOC. Once the vehicle's traction battery reaches 0% SOC, the indicator will flash. The indicator will also illuminate or flash if a fault occurs in the system.

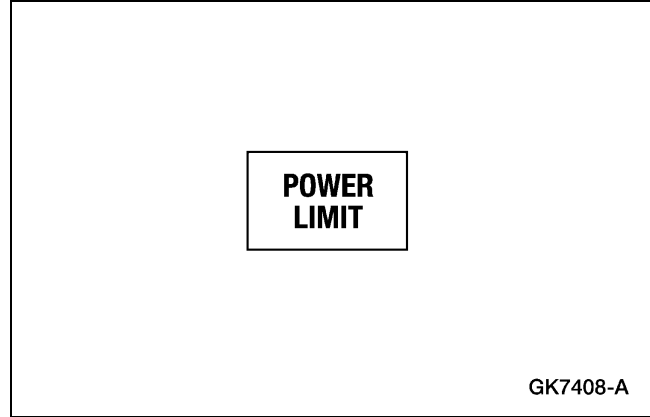

The power limit warning indicator is illuminated by the IAA module based upon data received from the TIM through the SCP network. The indicator indicates that the vehicle's performance has been limited due to a low SOC or a vehicle malfunction. The indicator will begin to flash when the vehicle's performance is severely limited due to an extremely low SOC or a vehicle malfunction. This indicates that the vehicle's performance has been further limited to allow for safe parking of the vehicle before the vehicle becomes unmovable under its own power. Diagnostic trouble codes (DTCs) should be retrieved from the TIM to determine the cause of the indicator's illumination. Possible causes are faults such as high temperature, a failure in the battery or traction system, or a low traction battery SOC.

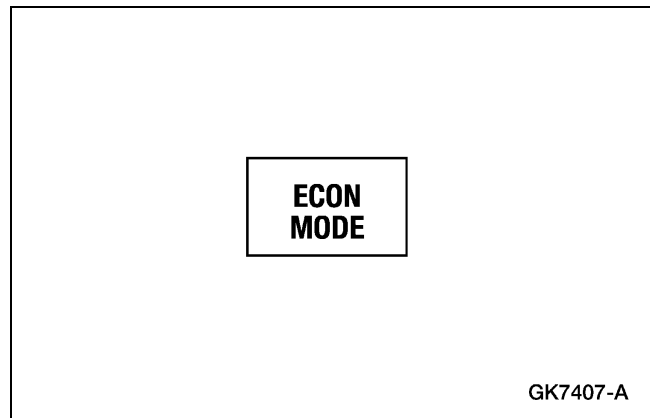



### DESCRIPTION AND OPERATION (Continued)

The economy mode indicator indicates that the gear selector has been switched into the E (Economy) position. Information from the TIM on the state of gear selection is transmitted to the IAA module through the SCP network. When shifted into the E position, the vehicle will operate as in D (Drive), but the top speed will be limited to 105 km/h (65 mph) and the effects of regenerative braking will be increased.

The power reset indicator indicates that the inertia switch has been tripped and all high voltage has been shut off. The vehicle should be inspected for damage that could result in a short circuit condition before the inertia switch is reset and the vehicle is operated. If the vehicle has not sustained any damage, the switch should be reset and the ignition key cycled to clear the resulting emergency power off (EPO) condition. There is no DTC stored in the IAA module for this condition.

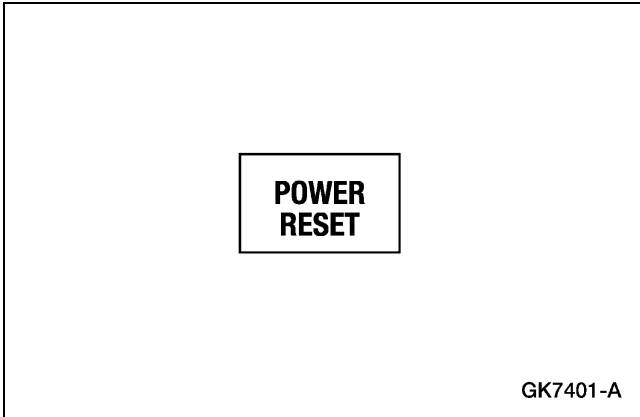

### Indicator Bulbs

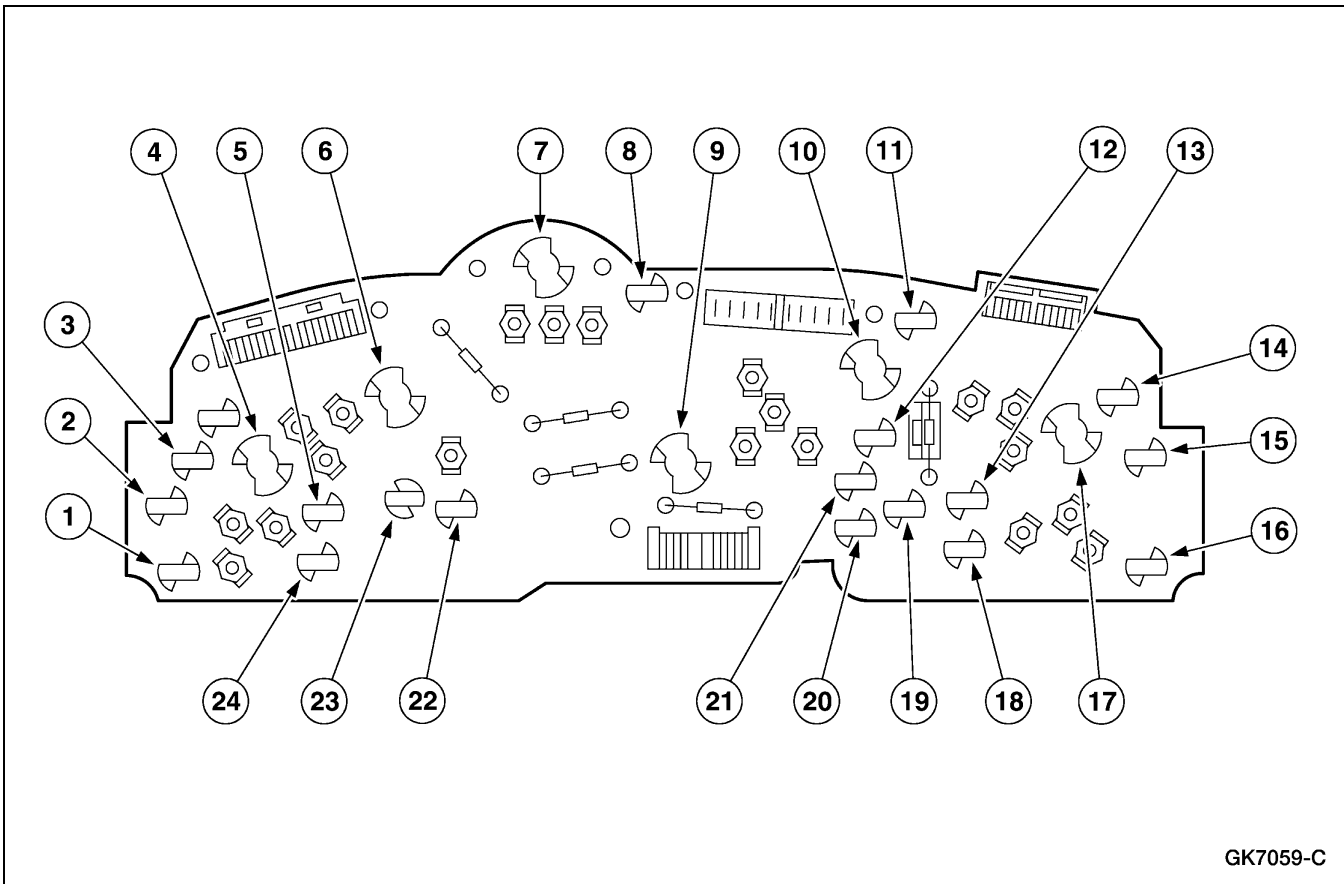

**DESCRIPTION AND OPERATION (Continued)**

Item	Description
1	Low Oil Pressure Indicator
2	Auxiliary Battery Indicator
3	Power Limit Warning Indicator
4	Cluster Illumination
5	Charge Indicator
6	Cluster Illumination
7	Cluster Illumination
8	Power Reset Indicator
9	Cluster Illumination
10	Cluster Illumination
11	Door Ajar Indicator
12	Cluster Illumination

(Continued)

Item	Description
13	ABS Warning Indicator
14	Malfunction Indicator Lamp (MIL)
15	Low State of Charge (SOC) Indicator
16	Seat Belt Indicator
17	Cluster Illumination
18	Hi Beam Indicator
19	Brake Warning Indicator
20	Left Turn Signal Indicator
21	Air Bag Indicator
22	Right Turn Signal Indicator
23	Electrical Hazard Warning Indicator (LED)
24	Economy Mode Indicator

The instrument cluster removal and installation for the Electric Ranger is the same as the standard gasoline Ranger. The bulb replacement also follows the same procedures; there are however, unique indicators. The preceding figure illustrates the name and location of the indicator lamps. Use the standard workshop manual to remove and replace the cluster, and use the preceding figure to identify and replace the bulbs.

**DIAGNOSIS AND TESTING****Instrument Cluster****Diagnostic Trouble Code (DTC) Definition**

The following DTC relates to the instrument cluster:

- DTC B1834 Gauge Drive Current Fault
  - The interface adapter assembly (IAA) module monitors the gauge drive circuits for the traction battery state of charge (SOC) gauge, the temperature gauge, and the economy gauge. The IAA module sets DTC B1834 if it detects an overcurrent condition in any of gauge drive circuits for the gauges identified earlier.

**Electrical Schematic**

Refer to Electrical and Vacuum Troubleshooting Manual, Cell 61, Instrument Cluster for schematic and connector information.

**Inspection and Verification**

Refer to [Section 100-07](#).

**DIAGNOSIS AND TESTING (Continued)****Symptom Chart****Symptom Chart**

<b>Condition</b>	<b>Possible Sources</b>	<b>Action</b>
<ul style="list-style-type: none"> <li>Speedometer, Malfunction Indicator Lamp (MIL), Power Reset Indicator, Charge Indicator, Auxiliary Battery Warning Indicator, Power Limit Warning Indicator, Low Oil Pressure Warning Indicator, Electrical Hazard Warning Indicator, and Door Ajar Indicator Do Not Operate</li> </ul>	<ul style="list-style-type: none"> <li>Fuse 1 (10A) (I/P fuse panel).</li> <li>Circuit 742 (LB wire).</li> </ul>	<ul style="list-style-type: none"> <li>CHECK 10A fuse 1. REPLACE if necessary. If OK, REPAIR circuit 742 (LB wire).</li> </ul>
<ul style="list-style-type: none"> <li>Speedometer, Economy Gauge, Low State of Charge (SOC) Indicator, Brake Warning Indicator, Air Bag Warning Indicator, Seat Belt Indicator, and Anti-lock Brake System (ABS) Warning Indicator Do Not Operate</li> </ul>	<ul style="list-style-type: none"> <li>Fuse 15 (7.5A) (I/P fuse panel).</li> <li>Circuit 584 (Y wire).</li> <li>Instrument cluster.</li> </ul>	<ul style="list-style-type: none"> <li>CHECK fuse 15. REPLACE if necessary. If OK, CHECK power (with key ON) to pin 4 (Y wire) on instrument cluster C216. If no power, REPAIR circuit 584 (Y wire). If OK, REPLACE the instrument cluster.</li> </ul>
<ul style="list-style-type: none"> <li>Speedometer, Economy Gauge, Motor Enabled Gauge, Traction Battery State of Charge (SOC) Gauge, Distance To Empty (DTE) Gauge, and Temperature Gauge Do Not Operate</li> </ul>	<ul style="list-style-type: none"> <li>Circuit 570 (BK/W wire).</li> <li>Instrument cluster.</li> </ul>	<ul style="list-style-type: none"> <li>CHECK circuit 570 (BK/W) for open. REPAIR if necessary. If OK, REPLACE the instrument cluster.</li> </ul>
<ul style="list-style-type: none"> <li>Temperature Gauge Indicates Way Above the H (Hot) Mark, Distance To Empty (DTE) Gauge Indicates Below the Miles Mark, Traction Battery State of Charge (SOC) Gauge Indicates Way Above the F (Full) Mark, and the Motor Enabled Gauge Indicates Way Above the ON Mark</li> </ul>	<ul style="list-style-type: none"> <li>Interface adapter assembly (IAA) module.</li> <li>Circuit.</li> </ul>	<ul style="list-style-type: none"> <li>GO to <a href="#">Pinpoint Test A</a>.</li> </ul>
<ul style="list-style-type: none"> <li>Speedometer Operates, But Odometer Does Not Operate</li> </ul>	<ul style="list-style-type: none"> <li>Speedometer.</li> </ul>	<ul style="list-style-type: none"> <li>REPLACE the instrument cluster.</li> </ul>
<ul style="list-style-type: none"> <li>Speedometer Does Not Operate or Indicates Incorrect Vehicle Speed</li> </ul>	<ul style="list-style-type: none"> <li>Instrument cluster.</li> <li>Traction inverter module (TIM).</li> <li>Circuit(s).</li> </ul>	<ul style="list-style-type: none"> <li>GO to <a href="#">Pinpoint Test B</a>.</li> </ul>
<ul style="list-style-type: none"> <li>DTC B1834 Gauge Drive Current Fault</li> </ul>	<ul style="list-style-type: none"> <li>Circuit(s).</li> <li>Instrument cluster.</li> </ul>	<ul style="list-style-type: none"> <li>CHECK circuits 3406 (DG/LG wire), 3048 (O wire), and 3408 (DB/O wire) for short(s) to ground. REPAIR as necessary. If OK, REPLACE the instrument cluster.</li> </ul>

**DIAGNOSIS AND TESTING (Continued)****Symptom Chart (Continued)**

<b>Condition</b>	<b>Possible Sources</b>	<b>Action</b>
<ul style="list-style-type: none"> <li>• Traction Battery State of Charge (SOC) Gauge Does Not Operate, Indicates Incorrect SOC, or Always Indicates F (Full)</li> </ul>	<ul style="list-style-type: none"> <li>• Instrument cluster.</li> <li>• Interface adapter assembly (IAA) module.</li> <li>• Circuit(s).</li> </ul>	<ul style="list-style-type: none"> <li>• GO to <a href="#">Pinpoint Test C.</a></li> </ul>
<ul style="list-style-type: none"> <li>• Temperature Gauge Does Not Operate Properly or Always Indicates H (Hot)</li> </ul>	<ul style="list-style-type: none"> <li>• Instrument cluster.</li> <li>• Interface adapter assembly (IAA) module.</li> <li>• Circuit(s).</li> </ul>	<ul style="list-style-type: none"> <li>• GO to <a href="#">Pinpoint Test D.</a></li> </ul>
<ul style="list-style-type: none"> <li>• Economy Gauge Does Not Operate Properly or Always Indicates + (Positive)</li> </ul>	<ul style="list-style-type: none"> <li>• Instrument cluster.</li> <li>• Interface adapter assembly (IAA) module.</li> <li>• Circuit(s).</li> </ul>	<ul style="list-style-type: none"> <li>• GO to <a href="#">Pinpoint Test E.</a></li> </ul>
<ul style="list-style-type: none"> <li>• Distance To Empty (DTE) Gauge Does Not Operate or Indicates Incorrect Distance to Empty</li> </ul>	<ul style="list-style-type: none"> <li>• Instrument cluster.</li> <li>• Interface adapter assembly (IAA) module.</li> <li>• Circuit(s).</li> </ul>	<ul style="list-style-type: none"> <li>• GO to <a href="#">Pinpoint Test F.</a></li> </ul>
<ul style="list-style-type: none"> <li>• Motor Enabled Gauge Does Not Operate or Indicates Way Above the ON Mark</li> </ul>	<ul style="list-style-type: none"> <li>• Interface adapter assembly (IAA) module.</li> <li>• Circuit(s).</li> <li>• Instrument cluster.</li> </ul>	<ul style="list-style-type: none"> <li>• GO to <a href="#">Pinpoint Test G.</a></li> </ul>
<ul style="list-style-type: none"> <li>• Malfunction Indicator Lamp (MIL) Does Not Operate or Stays On Continuously</li> </ul>	<ul style="list-style-type: none"> <li>• Interface adapter assembly (IAA) module.</li> <li>• Bulb.</li> <li>• Circuit(s).</li> <li>• Instrument cluster.</li> </ul>	<ul style="list-style-type: none"> <li>• GO to <a href="#">Pinpoint Test H.</a></li> </ul>
<ul style="list-style-type: none"> <li>• Power Reset Indicator Does Not Operate or Stays On Continuously</li> </ul>	<ul style="list-style-type: none"> <li>• Interface adapter assembly (IAA) module.</li> <li>• Bulb.</li> <li>• Circuit(s).</li> <li>• Instrument cluster.</li> </ul>	<ul style="list-style-type: none"> <li>• GO to <a href="#">Pinpoint Test J.</a></li> </ul>
<ul style="list-style-type: none"> <li>• Charging Indicator Does Not Operate or Stays On Continuously</li> </ul>	<ul style="list-style-type: none"> <li>• Interface adapter assembly (IAA) module.</li> <li>• Bulb.</li> <li>• Circuit(s).</li> <li>• Instrument cluster.</li> </ul>	<ul style="list-style-type: none"> <li>• GO to <a href="#">Pinpoint Test K.</a></li> </ul>
<ul style="list-style-type: none"> <li>• Economy Mode Indicator Does Not Operate or Stays On Continuously</li> </ul>	<ul style="list-style-type: none"> <li>• Interface adapter assembly (IAA) module.</li> <li>• Bulb.</li> <li>• Circuit(s).</li> <li>• Instrument cluster.</li> </ul>	<ul style="list-style-type: none"> <li>• GO to <a href="#">Pinpoint Test L.</a></li> </ul>
<ul style="list-style-type: none"> <li>• Auxiliary Battery Indicator Does Not Operate or Stays On Continuously</li> </ul>	<ul style="list-style-type: none"> <li>• Interface adapter assembly (IAA) module.</li> <li>• Bulb.</li> <li>• Circuit(s).</li> <li>• Instrument cluster.</li> </ul>	<ul style="list-style-type: none"> <li>• GO to <a href="#">Pinpoint Test M.</a></li> </ul>
<ul style="list-style-type: none"> <li>• Power Limit Warning Indicator Does Not Operate or Stays On Continuously</li> </ul>	<ul style="list-style-type: none"> <li>• Interface adapter assembly (IAA) module.</li> <li>• Bulb.</li> <li>• Circuit(s).</li> <li>• Instrument cluster.</li> </ul>	<ul style="list-style-type: none"> <li>• GO to <a href="#">Pinpoint Test N.</a></li> </ul>

**DIAGNOSIS AND TESTING (Continued)****Symptom Chart (Continued)**

<b>Condition</b>	<b>Possible Sources</b>	<b>Action</b>
<ul style="list-style-type: none"> <li>Low Oil Pressure Warning Indicator Does Not Operate or Stays On Continuously</li> </ul>	<ul style="list-style-type: none"> <li>Interface adapter assembly (IAA) module.</li> <li>Bulb.</li> <li>Circuit(s).</li> <li>Instrument cluster.</li> </ul>	<ul style="list-style-type: none"> <li>GO to <a href="#">Pinpoint Test P.</a></li> </ul>
<ul style="list-style-type: none"> <li>Electrical Hazard Warning Indicator Does Not Operate or Stays On Continuously</li> </ul>	<ul style="list-style-type: none"> <li>Interface adapter assembly (IAA) module.</li> <li>Bulb.</li> <li>Circuit(s).</li> <li>Instrument cluster.</li> </ul>	<ul style="list-style-type: none"> <li>GO to <a href="#">Pinpoint Test Q.</a></li> </ul>
<ul style="list-style-type: none"> <li>Low State of Charge (SOC) Indicator Does Not Operate or Stays On Continuously</li> </ul>	<ul style="list-style-type: none"> <li>Interface adapter assembly (IAA) module.</li> <li>Bulb.</li> <li>Circuit(s).</li> <li>Instrument cluster.</li> </ul>	<ul style="list-style-type: none"> <li>GO to <a href="#">Pinpoint Test R.</a></li> </ul>
<ul style="list-style-type: none"> <li>Red Brake Warning Indicator Does Not Operate or Stays On Continuously</li> </ul>	<ul style="list-style-type: none"> <li>Interface adapter assembly (IAA) module.</li> <li>Bulb.</li> <li>Circuit(s).</li> <li>Instrument cluster.</li> <li>Brake fluid level switch.</li> <li>Park brake switch.</li> </ul>	<ul style="list-style-type: none"> <li>GO to <a href="#">Pinpoint Test S.</a></li> </ul>
<ul style="list-style-type: none"> <li>Hi Beam Indicator Does Not Operate</li> </ul>	<ul style="list-style-type: none"> <li>Circuit(s).</li> <li>Bulb.</li> <li>Instrument cluster.</li> </ul>	<ul style="list-style-type: none"> <li>GO to <a href="#">Pinpoint Test T.</a></li> </ul>
<ul style="list-style-type: none"> <li>Left Turn Indicator Does Not Operate</li> </ul>	<ul style="list-style-type: none"> <li>Circuit(s).</li> <li>Bulb.</li> <li>Instrument cluster.</li> </ul>	<ul style="list-style-type: none"> <li>GO to <a href="#">Pinpoint Test U.</a></li> </ul>
<ul style="list-style-type: none"> <li>Right Turn Indicator Does Not Operate</li> </ul>	<ul style="list-style-type: none"> <li>Circuit(s).</li> <li>Bulb.</li> <li>Instrument cluster.</li> </ul>	<ul style="list-style-type: none"> <li>GO to <a href="#">Pinpoint Test V.</a></li> </ul>
<ul style="list-style-type: none"> <li>Instrument Cluster Illumination Lamps Do Not Operate</li> </ul>	<ul style="list-style-type: none"> <li>Circuit(s).</li> <li>Bulb.</li> <li>Instrument cluster.</li> </ul>	<ul style="list-style-type: none"> <li>GO to <a href="#">Pinpoint Test W.</a></li> </ul>
<ul style="list-style-type: none"> <li>Anti-Lock Brake System (ABS) Warning Indicator Does Not Operate</li> </ul>	<ul style="list-style-type: none"> <li>Anti-lock brake control module.</li> <li>Bulb.</li> <li>Circuit(s).</li> <li>Instrument cluster.</li> </ul>	<ul style="list-style-type: none"> <li>GO to <a href="#">Pinpoint Test X.</a></li> </ul>
<ul style="list-style-type: none"> <li>Anti-Lock Brake System (ABS) Warning Indicator Stays On Continuously</li> </ul>	<ul style="list-style-type: none"> <li>Anti-lock brake system (ABS).</li> </ul>	<ul style="list-style-type: none"> <li>REFER to <a href="#">Section 206-09.</a></li> </ul>
<ul style="list-style-type: none"> <li>Air Bag Indicator Does Not Operate</li> </ul>	<ul style="list-style-type: none"> <li>Air bag diagnostic monitor.</li> <li>Bulb.</li> <li>Circuit(s).</li> <li>Instrument cluster.</li> </ul>	<ul style="list-style-type: none"> <li>REFER to <b>Section 501-20B of the 2001 Ranger Workshop Manual.</b></li> </ul>
<ul style="list-style-type: none"> <li>Air Bag Indicator Stays On Continuously</li> </ul>	<ul style="list-style-type: none"> <li>Circuit(s).</li> <li>Air bag diagnostic monitor.</li> </ul>	<ul style="list-style-type: none"> <li>REFER to <b>Section 501-20B of the 2001 Ranger Workshop Manual.</b></li> </ul>
<ul style="list-style-type: none"> <li>Door Ajar Indicator Does Not Operate Properly</li> </ul>	<ul style="list-style-type: none"> <li>Generic electronic module (GEM).</li> <li>Bulb.</li> <li>Instrument cluster.</li> <li>Circuit(s).</li> </ul>	<ul style="list-style-type: none"> <li>GO to <a href="#">Pinpoint Test Y.</a></li> </ul>

**DIAGNOSIS AND TESTING (Continued)****Symptom Chart (Continued)**

Condition	Possible Sources	Action
<ul style="list-style-type: none"> <li>Seat Belt Indicator Does Not Operate Properly</li> </ul>	<ul style="list-style-type: none"> <li>Generic electronic module (GEM).</li> <li>Bulb.</li> <li>Instrument cluster.</li> <li>Circuit(s).</li> </ul>	<ul style="list-style-type: none"> <li>GO to <a href="#">Pinpoint Test Z</a>.</li> </ul>

**Pinpoint Tests****Special Tool(s)**

104-Pin Breakout Box (BOB) 418-049 (014-00950) or equivalent
BCM/TIM Breakout Box (BOB) Adapter Cable 418-F212
BCM/TIM Breakout Box (BOB) Overlay 418-F220

**PINPOINT TEST A: TEMPERATURE GAUGE INDICATES WAY ABOVE THE H (HOT) MARK, DISTANCE TO EMPTY (DTE) GAUGE INDICATES BELOW THE MILES MARK, TRACTION BATTERY STATE OF CHARGE (SOC) GAUGE INDICATES WAY ABOVE THE F (FULL) MARK, AND THE MOTOR ENABLED GAUGE INDICATES WAY ABOVE THE ON (MARK)**

TEST STEP	ACTION TO TAKE
<b>A1 CHECK INTERFACE ADAPTER ASSEMBLY (IAA) MODULE</b> <ul style="list-style-type: none"> <li>Connect 104-Pin Breakout Box (BOB) to the IAA module and IAA module C1945.</li> <li>With key ON, measure the voltage between BOB pin 41 and ground (BOB pin 80).</li> <li><b>Is the voltage greater than 10 volts?</b></li> </ul>	Yes = REPAIR circuit 3049 (BK/LG wire). No = REPLACE the IAA module. REFER to <a href="#">Section 412-04</a> .

**PINPOINT TEST B: SPEEDOMETER DOES NOT OPERATE OR INDICATES INCORRECT VEHICLE SPEED**

TEST STEP	ACTION TO TAKE
<b>B1 IDENTIFY SYMPTOM</b> <ul style="list-style-type: none"> <li>Enter the traction inverter module (TIM) active command mode SPEEDOMETER CONTROL and set the active command SPDOMETER to 30%.</li> <li><b>Does the speedometer indicate greater than 0 mph?</b></li> </ul>	Yes = GO to <b>B2</b> . No = GO to <b>B3</b> .
<b>B2 CHECK SPEEDOMETER FOR CORRECT SPEED</b> <ul style="list-style-type: none"> <li>Set the active command SPDOMETER to the following percentages and verify the speedometer operation:  <b>Percentage/Speed</b> <ul style="list-style-type: none"> <li>—10% = 16-21 km/h (10-13 mph)</li> <li>—20% = 29-34 km/h (18-21 mph)</li> <li>—30% = 43-48 km/h (27-30 mph)</li> <li>—40% = 60-64 km/h (37-40 mph)</li> <li>—50% = 72-77 km/h (45-48 mph)</li> <li>—60% = 87-92 km/h (54-57 mph)</li> <li>—70% = 100-105 km/h (62-65 mph)</li> </ul> </li> <li><b>Is the speedometer OK?</b></li> </ul>	Yes = System OK. CHECK wiring for intermittent connections. No = REPLACE the instrument cluster.
<b>B3 CHECK TRACTION INVERTER MODULE (TIM)</b> <ul style="list-style-type: none"> <li>Connect 104-Pin Breakout Box (BOB) to the TIM and TIM C4998, C4999 using the BCM/TIM BOB Adapter Cable and Overlay.</li> </ul>	Yes = GO to <b>B6</b> .

(Continued)

**DIAGNOSIS AND TESTING (Continued)****PINPOINT TEST B: SPEEDOMETER DOES NOT OPERATE OR INDICATES INCORRECT VEHICLE SPEED**

TEST STEP	ACTION TO TAKE
<ul style="list-style-type: none"> <li>Enter the TIM active command mode SPEEDOMETER CONTROL and set the active command SPDOMETER to 30%.</li> <li>Set the multimeter to the frequency setting and measure the frequency between BOB pin A7 and ground (BOB pin A29).</li> <li><b>Is the frequency greater than 70 Hz?</b></li> </ul>	No = GO to <b>B4</b> .
<b>B4 CHECK CIRCUIT 679 (GY/BK) FOR SHORT TO GROUND</b> <ul style="list-style-type: none"> <li>With key OFF, disconnect BOB from TIM; leave BOB connected to TIM C4998, C4999.</li> <li>With key OFF, disconnect instrument cluster C214, power steering assembly C1992, and generic electronic module (GEM) C224.</li> <li>With key OFF, measure the resistance between BOB pin A7 and ground (BOB pin A29).</li> <li><b>Is the resistance greater than 10,000 ohms?</b></li> </ul>	Yes = GO to <b>B5</b> . No = REPAIR the GY/BK wire.
<b>B5 CIRCUIT 679 (GY/BK) FOR SHORT TO POWER</b> <ul style="list-style-type: none"> <li>With key ON, measure the voltage between BOB pin A7 and ground (BOB pin A29).</li> <li><b>Is the voltage greater than 0 volts?</b></li> </ul>	Yes = REPAIR the GY/BK wire. No = REPLACE the TIM. REFER to <a href="#">Section 303-14</a> .
<b>B6 CHECK CIRCUIT 679 (GY/BK) FOR OPEN</b> <ul style="list-style-type: none"> <li>With key OFF, disconnect instrument cluster C214.</li> <li>Enter the TIM active command mode SPEEDOMETER CONTROL and set the active command SPDOMETER to 30%.</li> <li>Set the multimeter to the frequency setting and measure the frequency between pin 14 (GY/BK wire) on instrument cluster C214 and ground.</li> <li><b>Is the frequency greater than 70 Hz?</b></li> </ul>	Yes = GO to <b>B7</b> . No = REPAIR the GY/BK wire between instrument cluster C214 and TIM C4998.
<b>B7 CHECK POWER TO INSTRUMENT CLUSTER</b> <ul style="list-style-type: none"> <li>With key OFF, disconnect instrument cluster C215 and C216.</li> <li>With key ON, measure the voltage between pin 9 (LB wire) on instrument cluster C216 and pin 6 (BK/W wire) on instrument cluster C215.</li> <li><b>Is the voltage greater than 10 volts?</b></li> </ul>	Yes = REPLACE the instrument cluster. No = GO to <b>B8</b> .
<b>B8 CHECK GROUND TO INSTRUMENT CLUSTER</b> <ul style="list-style-type: none"> <li>With key OFF, measure the resistance between pin 6 (BK/W wire) on instrument cluster C215 and ground.</li> <li><b>Is the resistance less than 5 ohms?</b></li> </ul>	Yes = REPAIR circuit 742 (LB wire). No = REPAIR the BK/W wire.

**PINPOINT TEST C: TRACTION BATTERY STATE OF CHARGE (SOC) GAUGE DOES NOT OPERATE, INDICATES THE INCORRECT SOC, OR ALWAYS INDICATES F (FULL)**

TEST STEP	ACTION TO TAKE
<b>C1 IDENTIFY SYMPTOM</b>  <b>NOTE:</b> Do not carry out the following tests steps if interface adapter assembly (IAA) module DTC B1834 Gauge Drive Current Fault occurs. If DTC B1834 occurs, refer to the symptom chart. <ul style="list-style-type: none"> <li>With key ON, identify the symptom.</li> <li><b>Does the traction battery state of charge (SOC) gauge indicate F (full)?</b></li> </ul>	Yes = GO to <b>C6</b> . No = GO to <b>C2</b> .
<b>C2 CHECK TRACTION BATTERY STATE OF CHARGE (SOC) GAUGE</b>	

(Continued)

**DIAGNOSIS AND TESTING (Continued)****PINPOINT TEST C: TRACTION BATTERY STATE OF CHARGE (SOC) GAUGE DOES NOT OPERATE, INDICATES THE INCORRECT SOC, OR ALWAYS INDICATES F (FULL)**

TEST STEP	ACTION TO TAKE
<ul style="list-style-type: none"> <li>Enter the interface adapter assembly (IAA) module active command mode BATTERY STATE OF CHARGE and set the active command BAT SOC to 50%.</li> <li><b>Does the traction battery SOC gauge indicate above the E (empty) mark?</b></li> </ul>	Yes = GO to <b>C3</b> .  No = GO to <b>C4</b> .
<b>C3 CHECK TRACTION BATTERY SOC GAUGE FOR CORRECT SOC</b> <ul style="list-style-type: none"> <li>Set the active command BAT SOC to the following percentages and verify the traction battery SOC gauge operation:  <b>Percentage/SOC</b>            —15% = E (empty)            —30% = 0.25 mark            —50% = .50 mark            —65% = .75 mark            —75% = F (full)</li> <li><b>Is the traction battery SOC gauge OK?</b></li> </ul>	Yes = System OK. CHECK wiring for intermittent connections.  No = REPLACE the instrument cluster.
<b>C4 CHECK INTERFACE ADAPTER ASSEMBLY (IAA) MODULE</b> <ul style="list-style-type: none"> <li>Connect 104-Pin Breakout Box (BOB) to the IAA module and IAA module C1945.</li> <li>With key ON, connect a jumper wire between BOB pins 21 and 75.</li> <li><b>Does the traction battery SOC gauge indicate greater than F (full)?</b></li> </ul>	Yes = REPLACE the IAA module. REFER to <a href="#">Section 412-04</a> .  No = GO to <b>C5</b> .
<b>C5 CHECK CIRCUIT 3048 (O) FOR OPEN</b> <ul style="list-style-type: none"> <li>With key OFF, disconnect instrument cluster C215 and measure the resistance of the O wire between pin 4 on instrument cluster C215 and BOB pin 21.</li> <li><b>Is the resistance less than 5 ohms?</b></li> </ul>	Yes = REPLACE the instrument cluster.  No = REPAIR the O wire.
<b>C6 CHECK POWER TO INSTRUMENT CLUSTER</b> <ul style="list-style-type: none"> <li>With key OFF, disconnect instrument cluster C215.</li> <li>With key ON, measure the voltage between pin 11 (BK/LG wire) and pin 6 (BK/W wire) on instrument cluster C215.</li> <li><b>Is the voltage greater than 10 volts?</b></li> </ul>	Yes = GO to <b>C8</b> .  No = GO to <b>C7</b> .
<b>C7 CHECK GROUND TO INSTRUMENT CLUSTER</b> <ul style="list-style-type: none"> <li>With key OFF, measure the resistance between pin 6 (BK/W wire) on instrument cluster C215 and ground.</li> <li><b>Is the resistance less than 5 ohms?</b></li> </ul>	Yes = REPAIR circuit 3049 (BK/LG wire).  No = REPAIR the BK/W wire.
<b>C8 CHECK CIRCUIT 3048 (O) FOR SHORT TO POWER</b> <ul style="list-style-type: none"> <li>Connect 104-Pin Breakout Box (BOB) to the IAA module C1945; leave IAA module disconnected.</li> <li>With key ON, measure the voltage between BOB pin 21 and ground (BOB pin 80).</li> <li><b>Is the voltage greater than 0 volts?</b></li> </ul>	Yes = REPAIR the O wire.  No = GO to <b>C9</b> .
<b>C9 CHECK INSTRUMENT CLUSTER</b> <ul style="list-style-type: none"> <li>With key OFF, reconnect instrument cluster C215.</li> <li>With key OFF, connect BOB to IAA module; leave BOB connected to IAA module C1945.</li> <li>With key ON, connect a jumper wire between BOB pin 21 and ground (BOB pin 80).</li> <li><b>Does the traction battery SOC gauge indicate E (empty)?</b></li> </ul>	Yes = REPLACE the IAA module. REFER to <a href="#">Section 412-04</a> .  No = REPLACE the instrument cluster.



**DIAGNOSIS AND TESTING (Continued)****PINPOINT TEST D: TEMPERATURE GAUGE DOES NOT OPERATE PROPERLY OR ALWAYS INDICATES H (HOT)**

TEST STEP	ACTION TO TAKE
<p><b>D1 IDENTIFY SYMPTOM</b></p> <p><b>NOTE:</b> Do not carry out the following tests steps if interface adapter assembly (IAA) module DTC B1834 Gauge Drive Current Fault occurs. If DTC B1834 occurs, refer to the symptom chart.</p> <ul style="list-style-type: none"> <li>With key ON, identify the symptom.</li> <li><b>Does the temperature gauge indicate H (hot)?</b></li> </ul>	<p>Yes = GO to <b>D6</b>.</p> <p>No = GO to <b>D2</b>.</p>
<p><b>D2 CHECK TEMPERATURE GAUGE</b></p> <ul style="list-style-type: none"> <li>Enter the interface adapter assembly (IAA) module active command mode TEMPERATURE GAUGE and set the active command TEMP_G to 30%.</li> <li><b>Does the temperature gauge indicate above the C (cold) mark?</b></li> </ul>	<p>Yes = GO to <b>D3</b>.</p> <p>No = GO to <b>D4</b>.</p>
<p><b>D3 CHECK TEMPERATURE GAUGE FOR CORRECT TEMPERATURE REGION INDICATION</b></p> <ul style="list-style-type: none"> <li>Set the active command TEMP_G to the following percentages and verify the temperature gauge operation:  <b>Percentage/Temperature</b></li> </ul> <p>—15% = C (cold)  —35% = Bottom of normal region  —50% = Midscale  —65% = Top of normal region  —75% = H (hot)</p> <ul style="list-style-type: none"> <li><b>Is the temperature gauge OK?</b></li> </ul>	<p>Yes = System OK. CHECK wiring for intermittent connections.</p> <p>No = REPLACE the instrument cluster.</p>
<p><b>D4 CHECK INTERFACE ADAPTER ASSEMBLY (IAA) MODULE</b></p> <ul style="list-style-type: none"> <li>Connect 104-Pin Breakout Box (BOB) to the IAA module and IAA module C1945.</li> <li>With key ON, connect a jumper wire between BOB pins 20 and 75.</li> <li><b>Does the temperature gauge indicate greater than H (hot)?</b></li> </ul>	<p>Yes = REPLACE the IAA module. REFER to <a href="#">Section 412-04</a>.</p> <p>No = GO to <b>D5</b>.</p>
<p><b>D5 CHECK CIRCUIT 3406 (DG/LG) FOR OPEN</b></p> <ul style="list-style-type: none"> <li>With key OFF, disconnect instrument cluster C214 and measure the resistance of the DG/LG wire between pin 11 on instrument cluster C214 and BOB pin 20.</li> <li><b>Is the resistance less than 5 ohms?</b></li> </ul>	<p>Yes = REPLACE the instrument cluster.</p> <p>No = REPAIR the DG/LG wire.</p>
<p><b>D6 CHECK POWER TO INSTRUMENT CLUSTER</b></p> <ul style="list-style-type: none"> <li>With key OFF, disconnect instrument cluster C215.</li> <li>With key ON, measure the voltage between pin 12 (BK/LG wire) on instrument cluster C214 and pin 6 (BK/W wire) on instrument cluster C215.</li> <li><b>Is the voltage greater than 10 volts?</b></li> </ul>	<p>Yes = GO to <b>D8</b>.</p> <p>No = GO to <b>D7</b>.</p>
<p><b>D7 CHECK GROUND TO INSTRUMENT CLUSTER</b></p> <ul style="list-style-type: none"> <li>With key OFF, measure the resistance between pin 6 (BK/W wire) on instrument cluster C215 and ground.</li> <li><b>Is the resistance less than 5 ohms?</b></li> </ul>	<p>Yes = REPAIR circuit 3049 (BK/LG wire).</p> <p>No = REPAIR the BK/W wire.</p>
<p><b>D8 CHECK CIRCUIT 3406 (DG/LG) FOR SHORT TO POWER</b></p> <ul style="list-style-type: none"> <li>Connect 104-Pin Breakout Box (BOB) to the IAA module C1945; leave IAA module disconnected.</li> <li>With key ON, measure the voltage between BOB pin 20 and ground (BOB pin 80).</li> <li><b>Is the voltage greater than 0 volts?</b></li> </ul>	<p>Yes = REPAIR the DG/LG wire.</p> <p>No = GO to <b>D9</b>.</p>

(Continued)

**DIAGNOSIS AND TESTING (Continued)****PINPOINT TEST D: TEMPERATURE GAUGE DOES NOT OPERATE PROPERLY OR ALWAYS INDICATES H (HOT)**

TEST STEP	ACTION TO TAKE
<b>D9 CHECK INSTRUMENT CLUSTER</b> <ul style="list-style-type: none"> <li>With key OFF, reconnect instrument cluster C214, C215.</li> <li>With key OFF, connect BOB to IAA module; leave BOB connected to IAA module C1945.</li> <li>With key ON, connect a jumper wire between BOB pin 20 and ground (BOB pin 80).</li> <li><b>Does the temperature gauge indicate C (cold)?</b></li> </ul>	Yes = REPLACE the IAA module. REFER to <a href="#">Section 412-04</a> . No = REPLACE the instrument cluster.

**PINPOINT TEST E: ECONOMY GAUGE DOES NOT OPERATE PROPERLY OR ALWAYS INDICATES + (POSITIVE)**

TEST STEP	ACTION TO TAKE
<b>E1 IDENTIFY SYMPTOM</b> <p><b>NOTE:</b> Do not carry out the following tests steps if interface adapter assembly (IAA) module DTC B1834 Gauge Drive Current Fault occurs. If DTC B1834 occurs, refer to the symptom chart.</p> <ul style="list-style-type: none"> <li>With key ON, identify the symptom.</li> <li><b>Does the economy gauge indicate + (positive)?</b></li> </ul>	Yes = GO to E6. No = GO to E2.
<b>E2 CHECK ECONOMY GAUGE</b> <ul style="list-style-type: none"> <li>Enter the interface adapter assembly (IAA) module active command mode ECONOMY GAUGE and set the active command ECON_G to 30%.</li> <li><b>Does the economy gauge indicate above the - (negative) mark?</b></li> </ul>	Yes = GO to E3. No = GO to E4.
<b>E3 CHECK ECONOMY GAUGE FOR CORRECT INDICATION</b> <ul style="list-style-type: none"> <li>Set the active command ECON_G to the following percentages and verify the economy gauge operation:  <b>Percentage/Gauge Indication</b> <ul style="list-style-type: none"> <li>—20% = - (Negative) mark</li> <li>—35% = 0.25 position</li> <li>—55% = Midscale position</li> <li>—70% = 0.75 position</li> <li>—80% = + (Positive) mark</li> </ul> </li> <li><b>Is the economy gauge OK?</b></li> </ul>	Yes = System OK. CHECK wiring for intermittent connections. No = REPLACE the instrument cluster.
<b>E4 CHECK INTERFACE ADAPTER ASSEMBLY (IAA) MODULE</b> <ul style="list-style-type: none"> <li>Connect 104-Pin Breakout Box (BOB) to the IAA module and IAA module C1945.</li> <li>With key ON, connect a jumper wire between BOB pins 22 and 75.</li> <li><b>Does the economy gauge indicate greater than + (positive)?</b></li> </ul>	Yes = REPLACE the IAA module. REFER to <a href="#">Section 412-04</a> . No = GO to E5.
<b>E5 CHECK CIRCUIT 3408 (DB/O) FOR OPEN</b> <ul style="list-style-type: none"> <li>With key OFF, disconnect instrument cluster C214 and measure the resistance of the DB/O wire between pin 15 on instrument cluster C214 and BOB pin 22.</li> <li><b>Is the resistance less than 5 ohms?</b></li> </ul>	Yes = REPLACE the instrument cluster. No = REPAIR the DB/O wire.
<b>E6 CHECK POWER TO INSTRUMENT CLUSTER</b> <ul style="list-style-type: none"> <li>With key OFF, disconnect instrument cluster C215 and C216.</li> <li>With key ON, measure the voltage between pin 4 (Y wire) on instrument cluster C216 and pin 6 (BK/W wire) on instrument cluster C215.</li> <li><b>Is the voltage greater than 10 volts?</b></li> </ul>	Yes = GO to E8. No = GO to E7.

(Continued)

**DIAGNOSIS AND TESTING (Continued)****PINPOINT TEST E: ECONOMY GAUGE DOES NOT OPERATE PROPERLY OR ALWAYS INDICATES + (POSITIVE)**

TEST STEP	ACTION TO TAKE
<b>E7 CHECK GROUND TO INSTRUMENT CLUSTER</b> <ul style="list-style-type: none"> <li>With key OFF, measure the resistance between pin 6 (BK/W wire) on instrument cluster C215 and ground.</li> <li><b>Is the resistance less than 5 ohms?</b></li> </ul>	Yes = REPAIR circuit 584 (Y wire). No = REPAIR the BK/W wire.
<b>E8 CHECK IAA MODULE</b> <ul style="list-style-type: none"> <li>With key OFF, disconnect IAA module C1945.</li> <li>With key ON, check the economy gauge.</li> <li><b>Does the economy gauge indicate + (positive)?</b></li> </ul>	Yes = GO to <b>E9</b> . No = REPLACE the IAA module.
<b>E9 CHECK CIRCUIT 3408 (DB/O) FOR SHORT TO POWER</b> <ul style="list-style-type: none"> <li>Connect 104-Pin Breakout Box (BOB) to the IAA module C1945; leave IAA module disconnected.</li> <li>With key ON, measure the voltage between BOB pin 22 and ground (BOB pin 80).</li> <li><b>Is the voltage greater than 0 volts?</b></li> </ul>	Yes = REPAIR the DB/O wire. No = REPLACE the instrument cluster.

**PINPOINT TEST F: DISTANCE TO EMPTY (DTE) GAUGE DOES NOT OPERATE OR INDICATES INCORRECT DISTANCE TO EMPTY**

TEST STEP	ACTION TO TAKE
<b>F1 IDENTIFY SYMPTOM</b> <ul style="list-style-type: none"> <li>Enter the interface adapter assembly (IAA) module active command mode DISTANCE TO EMPTY GAUGE and set the active command DTE__G to 30%.</li> <li><b>Does the distance to empty (DTE) gauge indicate greater than 0 miles to empty?</b></li> </ul>	Yes = GO to <b>F2</b> . No = GO to <b>F3</b> .
<b>F2 CHECK DTE GAUGE FOR CORRECT DTE</b> <ul style="list-style-type: none"> <li>Set the active command DTE__G to the following percentages and verify the DTE gauge operation:  <b>Percentage/DTE</b> <ul style="list-style-type: none"> <li>—12% = 0-3.2 km (0-2 miles)</li> <li>—20% = 13-16 km (8-10 miles)</li> <li>—28% = 27-34 km/h (17-21 miles)</li> <li>—40% = 40-47 km (25-29 miles)</li> <li>—48% = 64-71 km (40-44 miles)</li> <li>—56% = 81-87 km (50-54 miles)</li> <li>—64% = 97-103 km (60-64 miles)</li> </ul> </li> <li><b>Is the DTE gauge OK?</b></li> </ul>	Yes = System OK. CHECK wiring for intermittent connections. No = REPLACE the instrument cluster.
<b>F3 CHECK INTERFACE ADAPTER ASSEMBLY (IAA) MODULE</b> <ul style="list-style-type: none"> <li>Connect 104-Pin Breakout Box (BOB) to the IAA module and IAA module C1945.</li> <li>Enter the IAA module active command mode DISTANCE TO EMPTY GAUGE and set the active command DTE__G to 30%.</li> <li>Set the multimeter to the frequency setting and measure the frequency between BOB pin 98 and ground (BOB pin 80).</li> <li><b>Is the frequency greater than 70 Hz?</b></li> </ul>	Yes = GO to <b>F4</b> . No = REPLACE the IAA module. REFER to <a href="#">Section 412-04</a> .
<b>F4 CHECK CIRCUIT 3047 (Y/W) FOR OPEN</b> <ul style="list-style-type: none"> <li>With key OFF, disconnect instrument cluster C214.</li> </ul>	Yes = GO to <b>F5</b> .

(Continued)

**DIAGNOSIS AND TESTING (Continued)****PINPOINT TEST F: DISTANCE TO EMPTY (DTE) GAUGE DOES NOT OPERATE OR INDICATES INCORRECT DISTANCE TO EMPTY**

TEST STEP	ACTION TO TAKE
<ul style="list-style-type: none"> <li>Enter the active command mode DISTANCE TO EMPTY GAUGE and set the active command DTE__G to 30%.</li> <li>Set the multimeter to the frequency setting and measure the frequency between pin 10 (Y/W wire) on instrument cluster C214 and ground.</li> <li><b>Is the frequency greater than 70 Hz?</b></li> </ul>	No = REPAIR the Y/W wire between instrument cluster C214 and IAA module C1945.
<b>F5 CHECK CIRCUIT 3047 (Y/W) FOR SHORT TO GROUND</b> <ul style="list-style-type: none"> <li>With key OFF, measure the resistance between BOB pin 98 and ground (BOB pin 80).</li> <li><b>Is the resistance greater than 10,000 ohms?</b></li> </ul>	Yes = GO to F6. No = REPAIR the Y/W wire between instrument cluster C214 and IAA module C1945.
<b>F6 CHECK CIRCUIT 3047 (Y/W) FOR SHORT TO POWER</b> <ul style="list-style-type: none"> <li>With key ON, measure the resistance between BOB pin 98 and ground (BOB pin 80).</li> <li><b>Is the voltage greater than 0 volts?</b></li> </ul>	Yes = REPAIR the Y/W wire between instrument cluster C214 and IAA module C1945. No = GO to F7.
<b>F7 CHECK POWER TO INSTRUMENT CLUSTER</b> <ul style="list-style-type: none"> <li>With key OFF, disconnect instrument cluster C215.</li> <li>With key ON, measure the voltage between pin 12 (BK/LG wire) on instrument cluster C214 and pin 6 (BK/W wire) on instrument cluster C215.</li> <li><b>Is the voltage greater than 10 volts?</b></li> </ul>	Yes = REPLACE the instrument cluster. No = GO to F8.
<b>F8 CHECK GROUND TO INSTRUMENT CLUSTER</b> <ul style="list-style-type: none"> <li>With key OFF, measure the resistance between pin 6 (BK/W wire) on instrument cluster C215 and ground.</li> <li><b>Is the resistance less than 5 ohms?</b></li> </ul>	Yes = REPAIR circuit 3049 (BK/LG wire). No = REPAIR the BK/W wire.

**PINPOINT TEST G: MOTOR ENABLED GAUGE DOES NOT OPERATE OR INDICATES WAY ABOVE THE ON MARK**

TEST STEP	ACTION TO TAKE
<b>G1 IDENTIFY SYMPTOM</b> <ul style="list-style-type: none"> <li>Turn the ignition key to the START position and identify the symptom.</li> <li><b>Does the motor enabled gauge indicate OFF?</b></li> </ul>	Yes = GO to G2. No = GO to G8.
<b>G2 CHECK MOTOR ENABLED GAUGE</b> <ul style="list-style-type: none"> <li>Enter the interface adapter assembly (IAA) module active command mode INSTRUMENTATION CONTROL and set the active commands GAUGE PWR to ON and MOTOR ENA to ON.</li> <li><b>Does the motor enabled gauge indicate ON?</b></li> </ul>	Yes = System OK. CHECK wiring for intermittent connections. No = GO to G3.
<b>G3 CHECK GAUGE DRIVE SIGNAL FROM INTERFACE ADAPTER ASSEMBLY (IAA) MODULE</b> <ul style="list-style-type: none"> <li>Connect 104-Pin Breakout Box (BOB) to the IAA module and IAA module C1945.</li> <li>With key ON, measure the voltage between BOB pin 15 and ground (BOB pin 80).</li> <li><b>Is the voltage greater than 10 volts?</b></li> </ul>	Yes = GO to G5. No = GO to G4.
<b>G4 CHECK CIRCUIT 3405 (GY/R) FOR SHORT TO GROUND</b>	

(Continued)

**DIAGNOSIS AND TESTING (Continued)****PINPOINT TEST G: MOTOR ENABLED GAUGE DOES NOT OPERATE OR INDICATES WAY ABOVE THE ON MARK**

TEST STEP	ACTION TO TAKE
<ul style="list-style-type: none"> <li>With key OFF, disconnect the IAA module from the BOB; leave BOB connected to IAA module C1945.</li> <li>With key OFF, measure the resistance between BOB pin 15 and ground (BOB pin 80).</li> <li><b>Is the resistance greater than 10,000 ohms?</b></li> </ul>	Yes = REPLACE the IAA module. REFER to <a href="#">Section 412-04</a> . No = REPAIR the GY/R wire.
<b>G5 CHECK CIRCUIT 3405 (GY/R) FOR OPEN</b> <ul style="list-style-type: none"> <li>With key OFF, disconnect instrument cluster C214 and measure the resistance of the GY/R wire between pin 13 on instrument cluster C214 and BOB pin 15.</li> <li><b>Is the resistance less than 5 ohms?</b></li> </ul>	Yes = GO to <b>G6</b> . No = REPAIR the GY/R wire.
<b>G6 CHECK POWER TO INSTRUMENT CLUSTER</b> <ul style="list-style-type: none"> <li>With key ON, measure the voltage between pin 4 (BK/LG wire) on instrument cluster C214 and pin 6 (BK/W wire) on instrument cluster C215.</li> <li><b>Is the voltage greater than 10 volts?</b></li> </ul>	Yes = REPLACE the instrument cluster. No = GO to <b>G7</b> .
<b>G7 CHECK GROUND TO INSTRUMENT CLUSTER</b> <ul style="list-style-type: none"> <li>With key OFF, measure the resistance between pin 6 (BK/W wire) on instrument cluster C215 and ground.</li> <li><b>Is the resistance less than 5 ohms?</b></li> </ul>	Yes = REPAIR circuit 3049 (BK/LG wire). No = REPAIR the BK/W wire.
<b>G8 CHECK CIRCUIT 3405 (GY/R) FOR SHORT TO POWER</b> <ul style="list-style-type: none"> <li>Connect 104-Pin Breakout Box (BOB) to IAA module C1945; leave IAA module disconnected.</li> <li>With key OFF, disconnect instrument cluster C214.</li> <li>With key ON, measure the voltage between BOB pin 15 and ground (BOB pin 80).</li> <li><b>Is the voltage greater than 0 volts?</b></li> </ul>	Yes = REPAIR the GY/R wire. No = REPLACE the instrument cluster.

**PINPOINT TEST H: MALFUNCTION INDICATOR LAMP (MIL) DOES NOT OPERATE OR STAYS ON CONTINUOUSLY**

TEST STEP	ACTION TO TAKE
<b>H1 IDENTIFY SYMPTOM</b> <p><b>NOTE:</b> If the malfunction indicator lamp (MIL) illuminates continuously, retrieve diagnostic trouble codes (DTCs) before carrying out the following test steps. If DTCs exist, refer to the appropriate DTC Index in Section 100-07. If no DTCs exist and the vehicle exhibits abnormal symptoms, refer to the Powertrain Diagnostic Routines Index in Section 100-09.</p> <ul style="list-style-type: none"> <li>With key ON, identify the symptom.</li> <li><b>Does the MIL stay on continuously?</b></li> </ul>	Yes = GO to <b>H8</b> . No = GO to <b>H2</b> .
<b>H2 CHECK OPERATION OF MALFUNCTION INDICATOR LAMP (MIL)</b> <ul style="list-style-type: none"> <li>Enter the interface adapter assembly (IAA) module active command mode INDICATOR LAMP CONTROL III and set the active command MIL to ON.</li> <li><b>Does the MIL illuminate?</b></li> </ul>	Yes = System OK. CHECK wiring for intermittent connections. No = GO to <b>H3</b> .
<b>H3 CHECK MIL CONTROL CIRCUIT</b> <ul style="list-style-type: none"> <li>Connect 104-Pin Breakout Box (BOB) to interface adapter assembly (IAA) module C1945; leave IAA module disconnected.</li> <li>With key OFF, connect a jumper wire between BOB pin 31 and ground (BOB pin 80).</li> <li><b>Does the MIL illuminate?</b></li> </ul>	Yes = REPLACE the IAA module. REFER to <a href="#">Section 412-04</a> . No = GO to <b>H4</b> .

(Continued)

**DIAGNOSIS AND TESTING (Continued)****PINPOINT TEST H: MALFUNCTION INDICATOR LAMP (MIL) DOES NOT OPERATE OR STAYS ON CONTINUOUSLY**

TEST STEP	ACTION TO TAKE
<b>H4 CHECK MIL BULB</b> <ul style="list-style-type: none"> <li>With key OFF, remove and check the MIL bulb.</li> <li><b>Is the bulb OK?</b></li> </ul>	Yes = GO to <b>H5</b> . No = REPLACE the bulb.
<b>H5 CHECK CIRCUIT 3045 (T) FOR OPEN</b> <ul style="list-style-type: none"> <li>With key OFF, disconnect instrument cluster C215 and measure the resistance of the T wire between pin 8 on instrument cluster C215 and BOB pin 31.</li> <li><b>Is the resistance less than 5 ohms?</b></li> </ul>	Yes = GO to <b>H6</b> . No = REPAIR the T wire.
<b>H6 CHECK CIRCUIT 3045 (T) FOR SHORT TO POWER</b> <ul style="list-style-type: none"> <li>With key ON, measure the voltage between BOB pin 31 and ground (BOB pin 80).</li> <li><b>Is the voltage greater than 0 volts?</b></li> </ul>	Yes = REPAIR the T wire. No = GO to <b>H7</b> .
<b>H7 CHECK POWER TO INSTRUMENT CLUSTER</b> <ul style="list-style-type: none"> <li>With key OFF, measure the voltage between pin 10 (LB wire) on instrument cluster C215 and ground.</li> <li><b>Is the voltage greater than 10 volts?</b></li> </ul>	Yes = REPLACE the instrument cluster. No = REPAIR circuit 742 (LB wire).
<b>H8 CHECK INSTRUMENT CLUSTER</b> <p><b>NOTE:</b> Carry out the following test steps only if the MIL illuminates continuously with the ignition key in the OFF position and the vehicle not connected to a power control station (PCS).</p> <ul style="list-style-type: none"> <li>Connect 104-Pin Breakout Box (BOB) to the IAA module and IAA module C1945.</li> <li>With key OFF, disconnect instrument cluster C215 and measure the resistance between BOB pin 31 and ground (BOB pin 80).</li> <li><b>Is the resistance greater than 10,000 ohms?</b></li> </ul>	Yes = REPLACE the instrument cluster. No = GO to <b>H9</b> .
<b>H9 CHECK CIRCUIT 3045 (T) FOR SHORT TO GROUND</b> <ul style="list-style-type: none"> <li>With key OFF, disconnect the IAA module from the BOB; leave BOB connected to IAA module C1945.</li> <li>With key OFF, measure the resistance between BOB pin 31 and ground (BOB pin 80).</li> <li><b>Is the resistance greater than 10,000 ohms?</b></li> </ul>	Yes = REPLACE the IAA module. REFER to <a href="#">Section 412-04</a> . No = REPAIR the T wire.

**PINPOINT TEST J: POWER RESET INDICATOR DOES NOT OPERATE OR STAYS ON CONTINUOUSLY**

TEST STEP	ACTION TO TAKE
<b>J1 IDENTIFY SYMPTOM</b> <p><b>NOTE:</b> If the power reset indicator illuminates and the vehicle will not start, refer to Emergency Power Off (EPO)/Interlock System in <a href="#">Section 414-03A</a> or <a href="#">Section 414-03B</a>.</p> <ul style="list-style-type: none"> <li>With key ON, identify the symptom.</li> <li><b>Does the power reset indicator stay on continuously?</b></li> </ul>	Yes = GO to <b>J8</b> . No = GO to <b>J2</b> .
<b>J2 CHECK OPERATION OF POWER RESET INDICATOR</b> <ul style="list-style-type: none"> <li>Enter the interface adapter assembly (IAA) module active command mode INDICATOR LAMP CONTROL III and set the active command ENG RESET to ON.</li> <li><b>Does the power reset indicator illuminate?</b></li> </ul>	Yes = System OK. CHECK wiring for intermittent connections. No = GO to <b>J3</b> .
<b>J3 CHECK POWER RESET INDICATOR CONTROL CIRCUIT</b> <ul style="list-style-type: none"> <li>Connect 104-Pin Breakout Box (BOB) to IAA module C1945; leave IAA module disconnected.</li> </ul>	Yes = REPLACE the IAA module. REFER to <a href="#">Section 412-04</a> .

(Continued)

**DIAGNOSIS AND TESTING (Continued)****PINPOINT TEST J: POWER RESET INDICATOR DOES NOT OPERATE OR STAYS ON CONTINUOUSLY**

TEST STEP	ACTION TO TAKE
<ul style="list-style-type: none"> <li>With key OFF, connect a jumper wire between BOB pin 9 and ground (BOB pin 80).</li> <li><b>Does the power reset indicator illuminate?</b></li> </ul>	No = GO to <b>J4</b> .
<b>J4 CHECK POWER RESET INDICATOR BULB</b> <ul style="list-style-type: none"> <li>With key OFF, remove and check the power reset indicator bulb.</li> <li><b>Is the bulb OK?</b></li> </ul>	Yes = GO to <b>J5</b> . No = REPLACE the bulb.
<b>J5 CHECK CIRCUIT 3402 (W/BK) FOR OPEN</b> <ul style="list-style-type: none"> <li>With key OFF, disconnect instrument cluster C215 and measure the resistance of the W/BK wire between pin 2 on instrument cluster C215 and BOB pin 9.</li> <li><b>Is the resistance less than 5 ohms?</b></li> </ul>	Yes = GO to <b>J6</b> . No = REPAIR the W/BK wire.
<b>J6 CHECK CIRCUIT 3402 (W/BK) FOR SHORT TO POWER</b> <ul style="list-style-type: none"> <li>With key ON, measure the voltage between BOB pin 9 and ground (BOB pin 80).</li> <li><b>Is the voltage greater than 0 volts?</b></li> </ul>	Yes = REPAIR the W/BK wire. No = GO to <b>J7</b> .
<b>J7 CHECK POWER TO INSTRUMENT CLUSTER</b> <ul style="list-style-type: none"> <li>With key OFF, measure the voltage between pin 1 (LB wire), pin 12 (LB wire) on instrument cluster C215 and ground.</li> <li><b>Is the voltage greater than 10 volts?</b></li> </ul>	Yes = REPLACE the instrument cluster. No = REPAIR the LB wire(s) in question.
<b>J8 CHECK INSTRUMENT CLUSTER</b> <ul style="list-style-type: none"> <li>Connect 104-Pin Breakout Box (BOB) to the IAA module and IAA module C1945.</li> <li>With key OFF, disconnect instrument cluster C215 and measure the resistance between BOB pin 9 and ground (BOB pin 80).</li> <li><b>Is the resistance greater than 10,000 ohms?</b></li> </ul>	Yes = REPLACE the instrument cluster. No = GO to <b>J9</b> .
<b>J9 CHECK CIRCUIT 3402 (W/BK) FOR SHORT TO GROUND</b> <ul style="list-style-type: none"> <li>With key OFF, disconnect the IAA module from the BOB; leave BOB connected to IAA module C1945.</li> <li>With key OFF, measure the resistance between BOB pin 9 and ground (BOB pin 80).</li> <li><b>Is the resistance greater than 10,000 ohms?</b></li> </ul>	Yes = REPLACE the IAA module. REFER to <a href="#">Section 412-04</a> . No = REPAIR the W/BK wire.

**PINPOINT TEST K: CHARGE INDICATOR DOES NOT OPERATE OR STAYS ON CONTINUOUSLY**

TEST STEP	ACTION TO TAKE
<b>K1 IDENTIFY SYMPTOM</b> <p><b>NOTE:</b> Verify the vehicle is not connected to a power control station (PCS) before carrying out the following test steps.</p> <ul style="list-style-type: none"> <li>With key ON, identify the symptom.</li> <li><b>Does the charge indicator stay on continuously?</b></li> </ul>	Yes = GO to <b>K8</b> . No = GO to <b>K2</b> .
<b>K2 CHECK OPERATION OF CHARGE INDICATOR</b> <ul style="list-style-type: none"> <li>Enter the interface adapter assembly (IAA) module active command mode INDICATOR LAMP CONTROL III and set the active command CHARGE to ON.</li> <li><b>Does the charge indicator illuminate?</b></li> </ul>	Yes = System OK. CHECK wiring for intermittent connections. No = GO to <b>K3</b> .
<b>K3 CHECK CHARGE INDICATOR CONTROL CIRCUIT</b> <ul style="list-style-type: none"> <li>Connect 104-Pin Breakout Box (BOB) to interface adapter assembly (IAA) module C1945; leave IAA module disconnected.</li> </ul>	Yes = REPLACE the IAA module. REFER to <a href="#">Section 412-04</a> .

(Continued)

**DIAGNOSIS AND TESTING (Continued)****PINPOINT TEST K: CHARGE INDICATOR DOES NOT OPERATE OR STAYS ON CONTINUOUSLY**

<b>TEST STEP</b>	<b>ACTION TO TAKE</b>
<ul style="list-style-type: none"> <li>With key OFF, connect a jumper wire between BOB pin 10 and ground (BOB pin 80).</li> <li><b>Does the charge indicator illuminate?</b></li> </ul>	No = GO to <b>K4</b> .
<b>K4 CHECK CHARGE INDICATOR BULB</b> <ul style="list-style-type: none"> <li>With key OFF, remove and check the charge indicator bulb.</li> <li><b>Is the bulb OK?</b></li> </ul>	Yes = GO to <b>K5</b> . No = REPLACE the bulb.
<b>K5 CHECK CIRCUIT 3041 (BK) FOR OPEN</b> <ul style="list-style-type: none"> <li>With key OFF, disconnect instrument cluster C214 and measure the resistance of the BK wire between pin 7 on instrument cluster C214 and BOB pin 10.</li> <li><b>Is the resistance less than 5 ohms?</b></li> </ul>	Yes = GO to <b>K6</b> . No = REPAIR the BK wire.
<b>K6 CHECK CIRCUIT 3041 (BK) FOR SHORT TO POWER</b> <ul style="list-style-type: none"> <li>With key ON, measure the voltage between BOB pin 9 and ground (BOB pin 80).</li> <li><b>Is the voltage greater than 0 volts?</b></li> </ul>	Yes = REPAIR the BK wire. No = GO to <b>K7</b> .
<b>K7 CHECK POWER TO INSTRUMENT CLUSTER</b> <ul style="list-style-type: none"> <li>With key OFF, measure the voltage between pin 1 (LB wire), pin 12 (LB wire) on instrument cluster C215 and ground.</li> <li><b>Is the voltage greater than 10 volts?</b></li> </ul>	Yes = REPLACE the instrument cluster. No = REPAIR the LB wire(s) in question.
<b>K8 CHECK INSTRUMENT CLUSTER</b> <ul style="list-style-type: none"> <li>Connect 104-Pin Breakout Box (BOB) to the IAA module and IAA module C1945.</li> <li>With key OFF, disconnect instrument cluster C214 and measure the resistance between BOB pin 10 and ground (BOB pin 80).</li> <li><b>Is the resistance greater than 10,000 ohms?</b></li> </ul>	Yes = REPLACE the instrument cluster. No = GO to <b>K9</b> .
<b>K9 CHECK CIRCUIT 3041 (BK) FOR SHORT TO GROUND</b> <ul style="list-style-type: none"> <li>With key OFF, disconnect the IAA module from the BOB; leave BOB connected to IAA module C1945.</li> <li>With key OFF, measure the resistance between BOB pin 10 and ground (BOB pin 80).</li> <li><b>Is the resistance greater than 10,000 ohms?</b></li> </ul>	Yes = REPLACE the IAA module. REFER to <a href="#">Section 412-04</a> . No = REPAIR the BK wire.

**PINPOINT TEST L: ECONOMY MODE INDICATOR DOES NOT OPERATE OR STAYS ON CONTINUOUSLY**

<b>TEST STEP</b>	<b>ACTION TO TAKE</b>
<b>L1 IDENTIFY SYMPTOM</b> <ul style="list-style-type: none"> <li>With key ON, identify the symptom.</li> <li><b>Does the economy mode indicator stay on continuously?</b></li> </ul>	Yes = GO to <b>L9</b> . No = GO to <b>L2</b> .
<b>L2 CHECK OPERATION OF ECONOMY MODE INDICATOR</b> <ul style="list-style-type: none"> <li>Enter the interface adapter assembly (IAA) module active command mode INDICATOR LAMP CONTROL and set the active command ECON MODE to ON.</li> <li><b>Does the economy mode indicator illuminate?</b></li> </ul>	Yes = System OK. CHECK wiring for intermittent connections. No = GO to <b>L3</b> .
<b>L3 CHECK ECONOMY MODE INDICATOR CONTROL CIRCUIT</b> <ul style="list-style-type: none"> <li>Connect 104-Pin Breakout Box (BOB) to interface adapter assembly (IAA) module C1945; leave IAA module disconnected.</li> <li>With key OFF, connect a jumper wire between BOB pin 17 and ground (BOB pin 80).</li> <li><b>Does the economy mode indicator illuminate?</b></li> </ul>	Yes = REPLACE the IAA module. REFER to <a href="#">Section 412-04</a> . No = GO to <b>L4</b> .
<b>L4 CHECK ECONOMY MODE INDICATOR BULB</b>	

(Continued)



**DIAGNOSIS AND TESTING (Continued)****PINPOINT TEST L: ECONOMY MODE INDICATOR DOES NOT OPERATE OR STAYS ON CONTINUOUSLY**

TEST STEP	ACTION TO TAKE
<ul style="list-style-type: none"> <li>With key OFF, remove and check the economy mode indicator bulb.</li> <li><b>Is the bulb OK?</b></li> </ul>	Yes = GO to <b>L5</b> . No = REPLACE the bulb.
<b>L5 CHECK CIRCUIT 3044 (LB) FOR OPEN</b> <ul style="list-style-type: none"> <li>With key OFF, disconnect instrument cluster C214 and measure the resistance of the LB wire between pin 5 on instrument cluster C214 and BOB pin 17.</li> <li><b>Is the resistance less than 5 ohms?</b></li> </ul>	Yes = GO to <b>L6</b> . No = REPAIR the LB wire.
<b>L6 CHECK CIRCUIT 3044 (LB) FOR SHORT TO POWER</b> <ul style="list-style-type: none"> <li>With key ON, measure the voltage between BOB pin 17 and ground (BOB pin 80).</li> <li><b>Is the voltage greater than 0 volts?</b></li> </ul>	Yes = REPAIR the LB wire. No = GO to <b>L7</b> .
<b>L7 CHECK POWER TO INSTRUMENT CLUSTER</b> <ul style="list-style-type: none"> <li>With key OFF, disconnect instrument cluster C215.</li> <li>With key ON, set the main light switch to the OFF position and measure the voltage between pin 5 (O/BK wire) on instrument cluster C215 and ground.</li> <li><b>Is the voltage greater than 10 volts?</b></li> </ul>	Yes = REPLACE the instrument cluster. No = GO to <b>L8</b> .
<b>L8 CHECK POWER TO MAIN LIGHT SWITCH</b> <ul style="list-style-type: none"> <li>With key OFF, disconnect main light switch C205.</li> <li>With key ON, measure the voltage between pin 4 (Y wire) on main light switch C205 and ground.</li> <li><b>Is the voltage greater than 10 volts?</b></li> </ul>	Yes = REPLACE the main light switch. No = REPAIR the Y wire.
<b>L9 CHECK INSTRUMENT CLUSTER</b> <ul style="list-style-type: none"> <li>Connect 104-Pin Breakout Box (BOB) to the IAA module and IAA module C1945.</li> <li>With key OFF, disconnect instrument cluster C214 and measure the resistance between BOB pin 17 and ground (BOB pin 80).</li> <li><b>Is the resistance greater than 10,000 ohms?</b></li> </ul>	Yes = REPLACE the instrument cluster. No = GO to <b>L10</b> .
<b>L10 CHECK CIRCUIT 3044 (LB) FOR SHORT TO GROUND</b> <ul style="list-style-type: none"> <li>With key OFF, disconnect the IAA module from the BOB; leave BOB connected to IAA module C1945.</li> <li>With key OFF, measure the resistance between BOB pin 17 and ground (BOB pin 80).</li> <li><b>Is the resistance greater than 10,000 ohms?</b></li> </ul>	Yes = REPLACE the IAA module. REFER to <a href="#">Section 412-04</a> . No = REPAIR the LB wire.

**PINPOINT TEST M: AUXILIARY BATTERY INDICATOR DOES NOT OPERATE OR STAYS ON CONTINUOUSLY**

TEST STEP	ACTION TO TAKE
<b>M1 IDENTIFY SYMPTOM</b> <p><b>NOTE:</b> If the auxiliary battery indicator illuminates continuously, retrieve diagnostic trouble codes (DTCs) before carrying out the following test steps. If DTCs exist, refer to the appropriate DTC Index in Section 100-07.</p> <ul style="list-style-type: none"> <li>With key ON, identify the symptom.</li> <li><b>Does the auxiliary battery indicator stay on continuously?</b></li> </ul>	Yes = GO to <b>M8</b> . No = GO to <b>M2</b> .
<b>M2 CHECK OPERATION OF AUXILIARY BATTERY INDICATOR</b> <ul style="list-style-type: none"> <li>Enter the interface adapter assembly (IAA) module active command mode INDICATOR LAMP CONTROL III and set the active command BATTERY to ON.</li> </ul>	Yes = System OK. CHECK wiring for intermittent connections.

(Continued)

**DIAGNOSIS AND TESTING (Continued)****PINPOINT TEST M: AUXILIARY BATTERY INDICATOR DOES NOT OPERATE OR STAYS ON CONTINUOUSLY**

TEST STEP	ACTION TO TAKE
<ul style="list-style-type: none"> <li>• Does the auxiliary battery indicator illuminate?</li> </ul>	No = GO to <b>M3</b> .
<b>M3 CHECK AUXILIARY BATTERY INDICATOR CONTROL CIRCUIT</b> <ul style="list-style-type: none"> <li>• Connect 104-Pin Breakout Box (BOB) to IAA module C1945; leave IAA module disconnected.</li> <li>• With key OFF, connect a jumper wire between BOB pin 32 and ground (BOB pin 80).</li> <li>• Does the auxiliary battery indicator illuminate?</li> </ul>	Yes = REPLACE the IAA module. REFER to <a href="#">Section 412-04</a> . No = GO to <b>M4</b> .
<b>M4 CHECK AUXILIARY BATTERY INDICATOR BULB</b> <ul style="list-style-type: none"> <li>• With key OFF, remove and check the auxiliary battery indicator bulb.</li> <li>• Is the bulb OK?</li> </ul>	Yes = GO to <b>M5</b> . No = REPLACE the bulb.
<b>M5 CHECK CIRCUIT 3046 (Y) FOR OPEN</b> <ul style="list-style-type: none"> <li>• With key OFF, disconnect instrument cluster C214 and measure the resistance of the Y wire between pin 1 on instrument cluster C214 and BOB pin 32.</li> <li>• Is the resistance less than 5 ohms?</li> </ul>	Yes = GO to <b>M6</b> . No = REPAIR the Y wire.
<b>M6 CHECK CIRCUIT 3046 (Y) FOR SHORT TO POWER</b> <ul style="list-style-type: none"> <li>• With key ON, measure the voltage between BOB pin 32 and ground (BOB pin 80).</li> <li>• Is the voltage greater than 0 volts?</li> </ul>	Yes = REPAIR the Y wire. No = GO to <b>M7</b> .
<b>M7 CHECK POWER TO INSTRUMENT CLUSTER</b> <ul style="list-style-type: none"> <li>• With key OFF, measure the voltage between pin 1 (LB wire), pin 12 (LB wire) on instrument cluster C215 and ground.</li> <li>• Is the voltage greater than 10 volts?</li> </ul>	Yes = REPLACE the instrument cluster. No = REPAIR the LB wire(s) in question.
<b>M8 CHECK DC/DC CONVERTER OPERATION</b> <p><b>NOTE:</b> Before proceeding, verify the power control station (PCS) is not plugged into the vehicle and all accessories (radio, A/C, heater, etc.) are turned off.</p> <ul style="list-style-type: none"> <li>• With key OFF, monitor the IAA module PID VBATIAA.</li> <li>• While monitoring the IAA module PID VBATIAA, turn the ignition key to the ON position.</li> <li>• Does the VBATIAA PID increase to approximately 13.7 volts?</li> </ul>	Yes = GO to <b>M9</b> . No = REFER to symptom chart in <a href="#">Section 414-02</a> .
<b>M9 CHECK INSTRUMENT CLUSTER</b> <ul style="list-style-type: none"> <li>• Connect 104-Pin Breakout Box (BOB) to the IAA module and IAA module C1945.</li> <li>• With key OFF, disconnect instrument cluster C214 and measure the resistance between BOB pin 32 and ground (BOB pin 80).</li> <li>• Is the resistance greater than 10,000 ohms?</li> </ul>	Yes = REPLACE the instrument cluster. No = GO to <b>M10</b> .
<b>M10 CHECK CIRCUIT 3046 (Y) FOR SHORT TO GROUND</b> <ul style="list-style-type: none"> <li>• With key OFF, disconnect the IAA module from the BOB; leave BOB connected to IAA module C1945.</li> <li>• With key OFF, measure the resistance between BOB pin 32 and ground (BOB pin 80).</li> <li>• Is the resistance greater than 10,000 ohms?</li> </ul>	Yes = REPLACE the IAA module. REFER to <a href="#">Section 412-04</a> . No = REPAIR the Y wire.

**DIAGNOSIS AND TESTING (Continued)****PINPOINT TEST N: POWER LIMIT WARNING INDICATOR DOES NOT OPERATE OR STAYS ON CONTINUOUSLY**

TEST STEP	ACTION TO TAKE
<p><b>N1 IDENTIFY SYMPTOM</b></p> <p><b>NOTE:</b> Verify no diagnostic trouble codes (DTCs) exist and the traction battery is charged to full state of charge (SOC) before carrying out the following test steps.</p> <ul style="list-style-type: none"> <li>With key ON, identify the symptom.</li> <li><b>Does the power limit warning indicator stay on continuously?</b></li> </ul>	<p>Yes = GO to <b>N8</b>.</p> <p>No = GO to <b>N2</b>.</p>
<p><b>N2 CHECK OPERATION OF POWER LIMIT WARNING INDICATOR</b></p> <ul style="list-style-type: none"> <li>Enter the interface adapter assembly (IAA) module active command mode INDICATOR LAMP CONTROL III and set the active command PWR LIMIT to ON.</li> <li><b>Does the power limit warning indicator illuminate?</b></li> </ul>	<p>Yes = System OK. CHECK wiring for intermittent connections.</p> <p>No = GO to <b>N3</b>.</p>
<p><b>N3 CHECK POWER LIMIT WARNING INDICATOR CONTROL CIRCUIT</b></p> <ul style="list-style-type: none"> <li>Connect 104-Pin Breakout Box (BOB) to IAA module C1945; leave IAA module disconnected.</li> <li>With key OFF, connect a jumper wire between BOB pin 8 and ground (BOB pin 80).</li> <li><b>Does the power limit warning indicator illuminate?</b></li> </ul>	<p>Yes = REPLACE the IAA module. REFER to <a href="#">Section 412-04</a>.</p> <p>No = GO to <b>N4</b>.</p>
<p><b>N4 CHECK POWER LIMIT WARNING INDICATOR BULB</b></p> <ul style="list-style-type: none"> <li>With key OFF, remove and check the power limit warning indicator bulb.</li> <li><b>Is the bulb OK?</b></li> </ul>	<p>Yes = GO to <b>N5</b>.</p> <p>No = REPLACE the bulb.</p>
<p><b>N5 CHECK CIRCUIT 3400 (BR/LB) FOR OPEN</b></p> <ul style="list-style-type: none"> <li>With key OFF, disconnect instrument cluster C214 and measure the resistance of the BR/LB wire between pin 3 on instrument cluster C214 and BOB pin 8.</li> <li><b>Is the resistance less than 5 ohms?</b></li> </ul>	<p>Yes = GO to <b>N6</b>.</p> <p>No = REPAIR the BR/LB wire.</p>
<p><b>N6 CHECK CIRCUIT 3400 (BR/LB) FOR SHORT TO POWER</b></p> <ul style="list-style-type: none"> <li>With key ON, measure the voltage between BOB pin 8 and ground (BOB pin 80).</li> <li><b>Is the voltage greater than 0 volts?</b></li> </ul>	<p>Yes = REPAIR the BR/LB wire.</p> <p>No = GO to <b>N7</b>.</p>
<p><b>N7 CHECK POWER TO INSTRUMENT CLUSTER</b></p> <ul style="list-style-type: none"> <li>With key OFF, measure the voltage between pin 1 (LB wire), pin 12 (LB wire) on instrument cluster C215 and ground.</li> <li><b>Is the voltage greater than 10 volts?</b></li> </ul>	<p>Yes = REPLACE the instrument cluster.</p> <p>No = REPAIR the LB wire(s) in question.</p>
<p><b>N8 CHECK INSTRUMENT CLUSTER</b></p> <ul style="list-style-type: none"> <li>Connect 104-Pin Breakout Box (BOB) to the IAA module and IAA module C1945.</li> <li>With key OFF, disconnect instrument cluster C214 and measure the resistance between BOB pin 8 and ground (BOB pin 80).</li> <li><b>Is the resistance greater than 10,000 ohms?</b></li> </ul>	<p>Yes = REPLACE the instrument cluster.</p> <p>No = GO to <b>N9</b>.</p>
<p><b>N9 CHECK CIRCUIT 3400 (BR/LB) FOR SHORT TO GROUND</b></p> <ul style="list-style-type: none"> <li>With key OFF, disconnect the IAA module from the BOB; leave BOB connected to IAA module C1945.</li> <li>With key OFF, measure the resistance between BOB pin 8 and ground (BOB pin 80).</li> <li><b>Is the resistance greater than 10,000 ohms?</b></li> </ul>	<p>Yes = REPLACE the IAA module. REFER to <a href="#">Section 412-04</a>.</p> <p>No = REPAIR the BR/LB wire.</p>

**DIAGNOSIS AND TESTING (Continued)****PINPOINT TEST P: LOW OIL PRESSURE INDICATOR DOES NOT OPERATE OR STAYS ON CONTINUOUSLY**

TEST STEP	ACTION TO TAKE
<p><b>P1 IDENTIFY SYMPTOM</b></p> <p><b>NOTE:</b> Verify no diagnostic trouble codes (DTCs) exist and there is no low oil pressure condition within the motor/transaxle before carrying out the following test steps.</p> <ul style="list-style-type: none"> <li>With key ON, identify the symptom.</li> <li><b>Does the low oil pressure indicator stay on continuously?</b></li> </ul>	<p>Yes = GO to <b>P8</b>.</p> <p>No = GO to <b>P2</b>.</p>
<p><b>P2 CHECK OPERATION OF LOW OIL PRESSURE INDICATOR</b></p> <ul style="list-style-type: none"> <li>Enter the interface adapter assembly (IAA) module active command mode INDICATOR LAMP CONTROL III and set the active command LOW LUBE to ON.</li> <li><b>Does the low oil pressure indicator illuminate?</b></li> </ul>	<p>Yes = System OK. CHECK wiring for intermittent connections.</p> <p>No = GO to <b>P3</b>.</p>
<p><b>P3 CHECK LOW OIL PRESSURE INDICATOR CONTROL CIRCUIT</b></p> <ul style="list-style-type: none"> <li>Connect 104-Pin Breakout Box (BOB) to IAA module C1945; leave IAA module disconnected.</li> <li>With key OFF, connect a jumper wire between BOB pin 12 and ground (BOB pin 80).</li> <li><b>Does the low oil pressure indicator illuminate?</b></li> </ul>	<p>Yes = REPLACE the IAA module. REFER to <a href="#">Section 412-04</a>.</p> <p>No = GO to <b>P4</b>.</p>
<p><b>P4 CHECK LOW OIL PRESSURE INDICATOR BULB</b></p> <ul style="list-style-type: none"> <li>With key OFF, remove and check the low oil pressure indicator bulb.</li> <li><b>Is the bulb OK?</b></li> </ul>	<p>Yes = GO to <b>P5</b>.</p> <p>No = REPLACE the bulb.</p>
<p><b>P5 CHECK CIRCUIT 3043 (W/PK) FOR OPEN</b></p> <ul style="list-style-type: none"> <li>With key OFF, disconnect instrument cluster C214 and measure the resistance of the W/PK wire between pin 2 on instrument cluster C214 and BOB pin 12.</li> <li><b>Is the resistance less than 5 ohms?</b></li> </ul>	<p>Yes = GO to <b>P6</b>.</p> <p>No = REPAIR the W/PK wire.</p>
<p><b>P6 CHECK CIRCUIT 3043 (W/PK) FOR SHORT TO POWER</b></p> <ul style="list-style-type: none"> <li>With key ON, measure the voltage between BOB pin 12 and ground (BOB pin 80).</li> <li><b>Is the voltage greater than 0 volts?</b></li> </ul>	<p>Yes = REPAIR the W/PK wire.</p> <p>No = GO to <b>P7</b>.</p>
<p><b>P7 CHECK POWER TO INSTRUMENT CLUSTER</b></p> <ul style="list-style-type: none"> <li>With key OFF, measure the voltage between pin 1 (LB wire), pin 12 (LB wire) on instrument cluster C215 and ground.</li> <li><b>Is the voltage greater than 10 volts?</b></li> </ul>	<p>Yes = REPLACE the instrument cluster.</p> <p>No = REPAIR the LB wire(s) in question.</p>
<p><b>P8 CHECK INSTRUMENT CLUSTER</b></p> <ul style="list-style-type: none"> <li>Connect 104-Pin Breakout Box (BOB) to the IAA module and IAA module C1945.</li> <li>With key OFF, disconnect instrument cluster C214 and measure the resistance between BOB pin 12 and ground (BOB pin 80).</li> <li><b>Is the resistance greater than 10,000 ohms?</b></li> </ul>	<p>Yes = REPLACE the instrument cluster.</p> <p>No = GO to <b>P9</b>.</p>
<p><b>P9 CHECK CIRCUIT 3043 (W/PK) FOR SHORT TO GROUND</b></p> <ul style="list-style-type: none"> <li>With key OFF, disconnect the IAA module from the BOB; leave BOB connected to IAA module C1945.</li> <li>With key OFF, measure the resistance between BOB pin 12 and ground (BOB pin 80).</li> <li><b>Is the resistance greater than 10,000 ohms?</b></li> </ul>	<p>Yes = REPLACE the IAA module. REFER to <a href="#">Section 412-04</a>.</p> <p>No = REPAIR the W/PK wire.</p>

**DIAGNOSIS AND TESTING (Continued)****PINPOINT TEST Q: ELECTRICAL HAZARD WARNING INDICATOR DOES NOT OPERATE OR STAYS ON CONTINUOUSLY**

TEST STEP	ACTION TO TAKE
<p><b>Q1 IDENTIFY SYMPTOM</b></p> <p><b>NOTE:</b> Verify no diagnostic trouble codes (DTCs) exist and the vehicle is capable of charging before carrying out the following test steps.</p> <ul style="list-style-type: none"> <li>• With key ON, identify the symptom.</li> <li>• <b>Does the electrical hazard warning indicator stay on continuously?</b></li> </ul>	<p>Yes = GO to <b>Q8</b>.</p> <p>No = GO to <b>Q2</b>.</p>
<p><b>Q2 CHECK OPERATION OF ELECTRICAL HAZARD WARNING INDICATOR</b></p> <ul style="list-style-type: none"> <li>• Enter the interface adapter assembly (IAA) module active command mode INDICATOR LAMP CONTROL III and set the active command HAZARD to ON.</li> <li>• <b>Does the electrical hazard warning indicator illuminate?</b></li> </ul>	<p>Yes = System OK. CHECK wiring for intermittent connections.</p> <p>No = GO to <b>Q3</b>.</p>
<p><b>Q3 CHECK ELECTRICAL HAZARD WARNING INDICATOR CONTROL CIRCUIT</b></p> <ul style="list-style-type: none"> <li>• Connect 104-Pin Breakout Box (BOB) to IAA module C1945; leave IAA module disconnected.</li> <li>• With key OFF, connect a jumper wire between BOB pin 13 and ground (BOB pin 80).</li> <li>• <b>Does the electrical hazard warning indicator illuminate?</b></li> </ul>	<p>Yes = REPLACE the IAA module. REFER to <a href="#">Section 412-04</a>.</p> <p>No = GO to <b>Q4</b>.</p>
<p><b>Q4 CHECK ELECTRICAL HAZARD WARNING INDICATOR LED</b></p> <ul style="list-style-type: none"> <li>• With key OFF, remove and check the electrical hazard warning indicator LED.</li> <li>• <b>Is the LED OK?</b></li> </ul>	<p>Yes = GO to <b>Q5</b>.</p> <p>No = REPLACE the bulb.</p>
<p><b>Q5 CHECK CIRCUIT 3407 (R/W) FOR OPEN</b></p> <ul style="list-style-type: none"> <li>• With key OFF, disconnect instrument cluster C214 and measure the resistance of the R/W wire between pin 9 on instrument cluster C214 and BOB pin 13.</li> <li>• <b>Is the resistance less than 5 ohms?</b></li> </ul>	<p>Yes = GO to <b>Q6</b>.</p> <p>No = REPAIR the R/W wire.</p>
<p><b>Q6 CHECK CIRCUIT 3407 (R/W) FOR SHORT TO POWER</b></p> <ul style="list-style-type: none"> <li>• With key ON, measure the voltage between BOB pin 13 and ground (BOB pin 80).</li> <li>• <b>Is the voltage greater than 0 volts?</b></li> </ul>	<p>Yes = REPAIR the R/W wire.</p> <p>No = GO to <b>Q7</b>.</p>
<p><b>Q7 CHECK POWER TO INSTRUMENT CLUSTER</b></p> <ul style="list-style-type: none"> <li>• With key OFF, measure the voltage between pin 1 (LB wire), pin 12 (LB wire) on instrument cluster C215 and ground.</li> <li>• <b>Is the voltage greater than 10 volts?</b></li> </ul>	<p>Yes = REPLACE the instrument cluster.</p> <p>No = REPAIR the LB wire(s) in question.</p>
<p><b>Q8 CHECK INSTRUMENT CLUSTER</b></p> <ul style="list-style-type: none"> <li>• Connect 104-Pin Breakout Box (BOB) to the IAA module and IAA module C1945.</li> <li>• With key OFF, disconnect instrument cluster C214 and measure the resistance between BOB pin 13 and ground (BOB pin 80).</li> <li>• <b>Is the resistance greater than 10,000 ohms?</b></li> </ul>	<p>Yes = REPLACE the instrument cluster.</p> <p>No = GO to <b>Q9</b>.</p>
<p><b>Q9 CHECK CIRCUIT 3407 (R/W) FOR SHORT TO GROUND</b></p> <ul style="list-style-type: none"> <li>• With key OFF, disconnect the IAA module from the BOB; leave BOB connected to IAA module C1945.</li> <li>• With key OFF, measure the resistance between BOB pin 13 and ground (BOB pin 80).</li> <li>• <b>Is the resistance greater than 10,000 ohms?</b></li> </ul>	<p>Yes = REPLACE the IAA module. REFER to <a href="#">Section 412-04</a>.</p> <p>No = REPAIR the R/W wire.</p>

**DIAGNOSIS AND TESTING (Continued)****PINPOINT TEST R: LOW STATE OF CHARGE (SOC) INDICATOR DOES NOT OPERATE OR STAYS ON CONTINUOUSLY**

TEST STEP	ACTION TO TAKE
<p><b>R1 IDENTIFY SYMPTOM</b></p> <p><b>NOTE:</b> Verify no diagnostic trouble codes (DTCs) exist and the traction battery is charged to full state of charge (SOC) before carrying out the following test steps.</p> <ul style="list-style-type: none"> <li>With key ON, identify the symptom.</li> <li><b>Does the low SOC indicator stay on continuously?</b></li> </ul>	<p>Yes = GO to <b>R8</b>.</p> <p>No = GO to <b>R2</b>.</p>
<p><b>R2 CHECK OPERATION OF LOW SOC INDICATOR</b></p> <ul style="list-style-type: none"> <li>Enter the interface adapter assembly (IAA) module active command mode INDICATOR LAMP CONTROL II and set the active command FUEL LOW to ON.</li> <li><b>Does the low SOC indicator illuminate?</b></li> </ul>	<p>Yes = System OK. CHECK wiring for intermittent connections.</p> <p>No = GO to <b>R3</b>.</p>
<p><b>R3 CHECK LOW SOC INDICATOR CONTROL CIRCUIT</b></p> <ul style="list-style-type: none"> <li>Connect 104-Pin Breakout Box (BOB) to IAA module C1945; leave IAA module disconnected.</li> <li>With key OFF, connect a jumper wire between BOB pin 11 and ground (BOB pin 80).</li> <li><b>Does the low SOC indicator illuminate?</b></li> </ul>	<p>Yes = REPLACE the IAA module. REFER to <a href="#">Section 412-04</a>.</p> <p>No = GO to <b>R4</b>.</p>
<p><b>R4 CHECK LOW SOC INDICATOR BULB</b></p> <ul style="list-style-type: none"> <li>With key OFF, remove and check the low SOC indicator bulb.</li> <li><b>Is the bulb OK?</b></li> </ul>	<p>Yes = GO to <b>R5</b>.</p> <p>No = REPLACE the bulb.</p>
<p><b>R5 CHECK CIRCUIT 3042 (PK/LG) FOR OPEN</b></p> <ul style="list-style-type: none"> <li>With key OFF, disconnect instrument cluster C215 and measure the resistance of the PK/LG wire between pin 7 on instrument cluster C215 and BOB pin 11.</li> <li><b>Is the resistance less than 5 ohms?</b></li> </ul>	<p>Yes = GO to <b>R6</b>.</p> <p>No = REPAIR the PK/LG wire.</p>
<p><b>R6 CHECK CIRCUIT 3042 (PK/LG) FOR SHORT TO POWER</b></p> <ul style="list-style-type: none"> <li>With key ON, measure the voltage between BOB pin 11 and ground (BOB pin 80).</li> <li><b>Is the voltage greater than 0 volts?</b></li> </ul>	<p>Yes = REPAIR the PK/LG wire.</p> <p>No = GO to <b>R7</b>.</p>
<p><b>R7 CHECK POWER TO INSTRUMENT CLUSTER</b></p> <ul style="list-style-type: none"> <li>With key OFF, disconnect instrument cluster C216.</li> <li>With key ON, measure the voltage between pin 4 (Y wire) on instrument cluster C216 and ground.</li> <li><b>Is the voltage greater than 10 volts?</b></li> </ul>	<p>Yes = REPLACE the instrument cluster.</p> <p>No = REPAIR the Y wire.</p>
<p><b>R8 CHECK INSTRUMENT CLUSTER</b></p> <ul style="list-style-type: none"> <li>Connect 104-Pin Breakout Box (BOB) to the IAA module and IAA module C1945.</li> <li>With key OFF, disconnect instrument cluster C215 and measure the resistance between BOB pin 11 and ground (BOB pin 80).</li> <li><b>Is the resistance greater than 10,000 ohms?</b></li> </ul>	<p>Yes = REPLACE the instrument cluster.</p> <p>No = GO to <b>R9</b>.</p>
<p><b>R9 CHECK CIRCUIT 3042 (PK/LG) FOR SHORT TO GROUND</b></p> <ul style="list-style-type: none"> <li>With key OFF, disconnect the IAA module from the BOB; leave BOB connected to IAA module C1945.</li> <li>With key OFF, measure the resistance between BOB pin 11 and ground (BOB pin 80).</li> <li><b>Is the resistance greater than 10,000 ohms?</b></li> </ul>	<p>Yes = REPLACE the IAA module. REFER to <a href="#">Section 412-04</a>.</p> <p>No = REPAIR the PK/LG wire.</p>

**DIAGNOSIS AND TESTING (Continued)****PINPOINT TEST S: RED BRAKE WARNING INDICATOR DOES NOT OPERATE OR STAYS ON CONTINUOUSLY**

TEST STEP	ACTION TO TAKE
<p><b>S1 IDENTIFY SYMPTOM</b></p> <p><b>NOTE:</b> Verify no diagnostic trouble codes (DTCs) exist and there are no hydraulic leaks in the brake system before carrying out the following test steps.</p> <ul style="list-style-type: none"> <li>With key ON, identify the symptom.</li> <li><b>Does the red brake warning indicator stay on continuously?</b></li> </ul>	<p>Yes = GO to <b>S13</b>.</p> <p>No = GO to <b>S2</b>.</p>
<p><b>S2 CHECK OPERATION OF RED BRAKE WARNING INDICATOR</b></p> <ul style="list-style-type: none"> <li>Enter the interface adapter assembly (IAA) module active command mode INDICATOR LAMP CONTROL and set the active command BRK LMP to ON.</li> <li><b>Does the red brake warning indicator illuminate?</b></li> </ul>	<p>Yes = GO to <b>S10</b>.</p> <p>No = GO to <b>S3</b>.</p>
<p><b>S3 CHECK RED BRAKE WARNING INDICATOR CONTROL CIRCUIT</b></p> <ul style="list-style-type: none"> <li>Connect 104-Pin Breakout Box (BOB) to IAA module C1945; leave IAA module disconnected.</li> <li>With key OFF, connect a jumper wire between BOB pin 39 and ground (BOB pin 80).</li> <li><b>Does the red brake warning indicator illuminate?</b></li> </ul>	<p>Yes = REPLACE the IAA module. REFER to <a href="#">Section 412-04</a>.</p> <p>No = GO to <b>S4</b>.</p>
<p><b>S4 CHECK RED BRAKE WARNING INDICATOR BULB</b></p> <ul style="list-style-type: none"> <li>With key OFF, remove and check the red brake warning indicator bulb.</li> <li><b>Is the bulb OK?</b></li> </ul>	<p>Yes = GO to <b>S5</b>.</p> <p>No = REPLACE the bulb.</p>
<p><b>S5 CHECK RED BRAKE WARNING INDICATOR CONTROL CIRCUIT FOR OPEN</b></p> <ul style="list-style-type: none"> <li>With key OFF, disconnect instrument cluster C216 and measure the resistance between pin 7 (P/W wire) on instrument cluster C216 and BOB pin 39.</li> <li><b>Is the resistance less than 5 ohms?</b></li> </ul>	<p>Yes = GO to <b>S8</b>.</p> <p>No = GO to <b>S6</b>.</p>
<p><b>S6 CHECK CIRCUIT 512 (T/LG) FOR OPEN</b></p> <ul style="list-style-type: none"> <li>With key OFF, disconnect brake fluid level switch C137 and measure the resistance of the T/LG wire between brake fluid level switch C137 and BOB pin 39.</li> <li><b>Is the resistance less than 5 ohms?</b></li> </ul>	<p>Yes = GO to <b>S7</b>.</p> <p>No = REPAIR the T/LG wire.</p>
<p><b>S7 CHECK CONTINUITY OF BRAKE FLUID LEVEL SWITCH</b></p> <ul style="list-style-type: none"> <li>With key OFF, measure the resistance between the T/LG wire terminal and P/W wire terminal on the brake fluid level switch.</li> <li><b>Is the resistance less than 5 ohms?</b></li> </ul>	<p>Yes = REPAIR the P/W wire between instrument cluster C216 and brake fluid level switch C137.</p> <p>No = REPLACE the brake fluid level switch.</p>
<p><b>S8 CHECK CONTROL CIRCUIT FOR SHORT TO POWER</b></p> <ul style="list-style-type: none"> <li>With key ON, measure the voltage between BOB pin 39 and ground (BOB pin 80).</li> <li><b>Is the voltage greater than 0 volts?</b></li> </ul>	<p>Yes = REPAIR the T/LG, P/W, or LG/R wire.</p> <p>No = GO to <b>S9</b>.</p>
<p><b>S9 CHECK POWER TO INSTRUMENT CLUSTER</b></p> <ul style="list-style-type: none"> <li>With key ON, measure the voltage between pin 4 (Y wire) on instrument cluster C216 and ground.</li> <li><b>Is the voltage greater than 10 volts?</b></li> </ul>	<p>Yes = REPLACE the instrument cluster.</p> <p>No = REPAIR the Y wire.</p>
<p><b>S10 CHECK OPERATION OF BRAKE WARNING INDICATOR WITH PARK BRAKE DEPRESSED</b></p>	

(Continued)

**DIAGNOSIS AND TESTING (Continued)****PINPOINT TEST S: RED BRAKE WARNING INDICATOR DOES NOT OPERATE OR STAYS ON CONTINUOUSLY**

TEST STEP	ACTION TO TAKE
<ul style="list-style-type: none"> <li>With key ON, depress the park brake pedal.</li> <li><b>Does the red brake warning indicator illuminate?</b></li> </ul>	Yes = GO to <b>S12</b> . No = GO to <b>S11</b> .
<b>S11 CHECK PARK BRAKE SWITCH</b> <ul style="list-style-type: none"> <li>With key OFF, disconnect park brake switch C202.</li> <li>With key ON, connect a jumper wire between the LG/R wire on park brake switch C202 and ground.</li> <li><b>Does the red brake warning indicator illuminate?</b></li> </ul>	Yes = REPLACE the park brake switch. No = REPAIR the LG/R wire.
<b>S12 CHECK GROUND TO BRAKE FLUID LEVEL SWITCH</b> <ul style="list-style-type: none"> <li>With key OFF, measure the resistance between the BK wire on brake fluid level switch C202 and ground.</li> <li><b>Is the resistance less than 5 ohms?</b></li> </ul>	Yes = System OK. CHECK wiring for intermittent connections. No = REPAIR the BK wire.
<b>S13 CHECK INSTRUMENT CLUSTER</b> <ul style="list-style-type: none"> <li>Connect 104-Pin Breakout Box (BOB) to the IAA module and IAA module C1945.</li> <li>With key OFF, disconnect instrument cluster C216 and measure the resistance between BOB pin 39 and ground (BOB pin 80).</li> <li><b>Is the resistance greater than 10,000 ohms?</b></li> </ul>	Yes = REPLACE the instrument cluster. No = GO to <b>S14</b> .
<b>S14 CHECK CIRCUIT 512 (T/LG) FOR SHORT TO GROUND</b> <ul style="list-style-type: none"> <li>With key OFF, disconnect the IAA module from the BOB; leave BOB connected to IAA module C1945.</li> <li>With key OFF, disconnect brake fluid level switch C137 and measure the resistance between BOB pin 39 and ground (BOB pin 80).</li> <li><b>Is the resistance greater than 10,000 ohms?</b></li> </ul>	Yes = GO to <b>S15</b> . No = REPAIR the T/LG wire.
<b>S15 CHECK BRAKE FLUID LEVEL SWITCH</b> <ul style="list-style-type: none"> <li>With key OFF, measure the resistance between the P/W wire terminal and BK wire terminal on the brake fluid level switch C137.</li> <li><b>Is the resistance greater than 10,000 ohms?</b></li> </ul>	Yes = GO to <b>S16</b> . No = REPLACE the brake fluid level switch.
<b>S16 CHECK PARK BRAKE SWITCH</b> <p><b>NOTE:</b> Verify the park brake pedal is not depressed before carrying out this test step.</p> <ul style="list-style-type: none"> <li>With key OFF, disconnect park brake switch C202 and measure the resistance between the LG/R wire terminal on park brake switch C202 and ground.</li> <li><b>Is the resistance greater than 10,000 ohms?</b></li> </ul>	Yes = GO to <b>S17</b> . No = REPLACE the park brake switch.
<b>S17 CHECK CIRCUIT 162 (LG/R) FOR SHORT TO GROUND</b> <ul style="list-style-type: none"> <li>With key OFF, disconnect park brake switch C202 and daytime running lamps (DRL) module C150 (if equipped), and measure the resistance between the LG/R wire on brake fluid level switch C137 and ground.</li> <li><b>Is the resistance greater than 10,000 ohms?</b></li> </ul>	Yes = REPLACE the IAA module. REFER to <a href="#">Section 412-04</a> . No = REPAIR the LG/R wire.

**PINPOINT TEST T: HI BEAM INDICATOR DOES NOT OPERATE**

TEST STEP	ACTION TO TAKE
<b>T1 CHECK POWER TO INSTRUMENT CLUSTER</b> <ul style="list-style-type: none"> <li>With key OFF, disconnect instrument cluster C216.</li> </ul>	Yes = GO to <b>T2</b> .

(Continued)



**DIAGNOSIS AND TESTING (Continued)****PINPOINT TEST T: HI BEAM INDICATOR DOES NOT OPERATE**

TEST STEP	ACTION TO TAKE
<ul style="list-style-type: none"> <li>Turn the headlamp switch to the ON position, set the multi-function switch to the high beam position and measure the voltage between pin 1 (LG/BK wire) on instrument cluster C216 and ground.</li> <li><b>Is the voltage greater than 10 volts?</b></li> </ul>	No = REPAIR the LG/BK wire.
<b>T2 CHECK GROUND TO INSTRUMENT CLUSTER</b> <ul style="list-style-type: none"> <li>With key OFF, measure the resistance between pin 2 (BK wire) on instrument cluster C216 and ground.</li> <li><b>Is the resistance less than 5 ohms?</b></li> </ul>	Yes = GO to T3. No = REPAIR the BK wire.
<b>T3 CHECK HI BEAM INDICATOR BULB</b> <ul style="list-style-type: none"> <li>With key OFF, remove and check the hi beam indicator bulb.</li> <li><b>Is the bulb OK?</b></li> </ul>	Yes = REPLACE the instrument cluster. No = REPLACE the bulb.

**PINPOINT TEST U: LEFT TURN INDICATOR DOES NOT OPERATE**

TEST STEP	ACTION TO TAKE
<b>U1 CHECK POWER TO INSTRUMENT CLUSTER</b> <ul style="list-style-type: none"> <li>With key OFF, disconnect instrument cluster C216.</li> <li>With key ON, set the multi-function switch to the left turn position and measure the voltage between pin 5 (LG/W wire) on instrument cluster C216 and ground.</li> <li><b>Does the voltage vary from 0 to greater than 10 volts?</b></li> </ul>	Yes = GO to U2. No = REPAIR the LG/W wire.
<b>U2 CHECK GROUND TO INSTRUMENT CLUSTER</b> <ul style="list-style-type: none"> <li>With key OFF, measure the resistance between pin 2 (BK wire) on instrument cluster C216 and ground.</li> <li><b>Is the resistance less than 5 ohms?</b></li> </ul>	Yes = GO to U3. No = REPAIR the BK wire.
<b>U3 CHECK LEFT TURN INDICATOR BULB</b> <ul style="list-style-type: none"> <li>With key OFF, remove and check the left turn indicator bulb.</li> <li><b>Is the bulb OK?</b></li> </ul>	Yes = REPLACE the instrument cluster. No = REPLACE the bulb.

**PINPOINT TEST V: RIGHT TURN INDICATOR DOES NOT OPERATE**

TEST STEP	ACTION TO TAKE
<b>V1 CHECK POWER TO INSTRUMENT CLUSTER</b> <ul style="list-style-type: none"> <li>With key OFF, disconnect instrument cluster C214.</li> <li>With key ON, set the multi-function switch to the right turn position and measure the voltage between pin 8 (W/LB wire) on instrument cluster C214 and ground.</li> <li><b>Does the voltage vary from 0 to greater than 10 volts?</b></li> </ul>	Yes = GO to V2. No = REPAIR the W/LB wire.
<b>V2 CHECK GROUND TO INSTRUMENT CLUSTER</b> <ul style="list-style-type: none"> <li>With key OFF, disconnect instrument cluster C216 and measure the resistance between pin 2 (BK wire) on instrument cluster C216 and ground.</li> <li><b>Is the resistance less than 5 ohms?</b></li> </ul>	Yes = GO to V3. No = REPAIR the BK wire.
<b>V3 CHECK RIGHT TURN INDICATOR BULB</b> <ul style="list-style-type: none"> <li>With key OFF, remove and check the right turn indicator bulb.</li> <li><b>Is the bulb OK?</b></li> </ul>	Yes = REPLACE the instrument cluster. No = REPLACE the bulb.

**DIAGNOSIS AND TESTING (Continued)****PINPOINT TEST W: INSTRUMENT CLUSTER ILLUMINATION LAMPS DO NOT OPERATE**

TEST STEP	ACTION TO TAKE
<b>W1 CHECK CIRCUIT 19 (LB/R) FOR OPEN(S)</b> <ul style="list-style-type: none"> <li>With key OFF, disconnect instrument illumination dimming module C204 and instrument cluster C214 and C215.</li> <li>With key OFF, measure the resistance of the LB/R wire between pin 4 on instrument illumination dimming module C204 and pin 6 on instrument cluster C214.</li> <li>With key OFF, measure the resistance of the LB/R wire between pin 4 on instrument illumination dimming module C204 and pin 3 on instrument cluster C215.</li> <li><b>Are the resistances less than 5 ohms?</b></li> </ul>	Yes = GO to <b>W2</b> . No = REPAIR the LB/R wire(s) in question.
<b>W2 CHECK GROUND TO INSTRUMENT CLUSTER</b> <ul style="list-style-type: none"> <li>With key OFF, measure the resistance between pin 16 (BK wire) on instrument cluster C214 and ground.</li> <li><b>Is the resistance less than 5 ohms?</b></li> </ul>	Yes = GO to <b>W3</b> . No = REPAIR the BK wire.
<b>W3 CHECK INSTRUMENT CLUSTER ILLUMINATION BULB(S)</b> <ul style="list-style-type: none"> <li>With key OFF, remove and check the instrument cluster illumination bulb(s) in question.</li> <li><b>Are the bulbs OK?</b></li> </ul>	Yes = REPLACE the instrument cluster. No = REPLACE the bulb(s) in question.

**PINPOINT TEST X: ANTI-LOCK BRAKE SYSTEM (ABS) WARNING INDICATOR DOES NOT OPERATE**

TEST STEP	ACTION TO TAKE
<b>X1 VERIFY ANTI-LOCK BRAKE SYSTEM (ABS) WARNING INDICATOR OPERATION</b> <ul style="list-style-type: none"> <li>With key ON, check the anti-lock brake system (ABS) warning indicator.</li> <li><b>Does the ABS warning indicator prove out?</b></li> </ul>	Yes = System OK. CHECK wiring for intermittent connections. No = GO to <b>X2</b> .
<b>X2 CHECK ABS WARNING INDICATOR CONTROL CIRCUIT</b> <ul style="list-style-type: none"> <li>With key OFF, disconnect anti-lock brake control module C154.</li> <li>With key ON, connect a jumper wire between pin 16 (DG wire) on anti-lock brake control module C154 and ground.</li> <li><b>Does the ABS warning indicator illuminate?</b></li> </ul>	Yes = REPLACE the anti-lock brake control module. REFER to <a href="#">Section 206-09</a> . No = GO to <b>X3</b> .
<b>X3 CHECK ABS WARNING INDICATOR BULB</b> <ul style="list-style-type: none"> <li>With key OFF, remove and check the ABS warning indicator bulb.</li> <li><b>Is the bulb OK?</b></li> </ul>	Yes = GO to <b>X4</b> . No = REPLACE the bulb.
<b>X4 CHECK CIRCUIT 603 (DG) FOR OPEN</b> <ul style="list-style-type: none"> <li>With key OFF, disconnect instrument cluster C216 and measure the resistance of the DG wire between pin 6 on instrument cluster C216 and pin 16 on anti-lock brake control module C154.</li> <li><b>Is the resistance less than 5 ohms?</b></li> </ul>	Yes = GO to <b>X5</b> . No = REPAIR the DG wire.
<b>X5 CHECK CIRCUIT 603 (DG) FOR SHORT TO POWER</b> <ul style="list-style-type: none"> <li>With key ON, measure the voltage between pin 16 (DG wire) and ground.</li> <li><b>Is the voltage greater than 0 volts?</b></li> </ul>	Yes = REPAIR the DG wire. No = GO to <b>X6</b> .
<b>X6 CHECK POWER TO INSTRUMENT CLUSTER</b> <ul style="list-style-type: none"> <li>With key ON, measure the voltage between pin 4 (Y wire) on instrument cluster C216 and ground.</li> <li><b>Is the voltage greater than 10 volts?</b></li> </ul>	Yes = REPLACE the instrument cluster. No = REPAIR the Y wire.



**DIAGNOSIS AND TESTING (Continued)****PINPOINT TEST Y: DOOR AJAR INDICATOR DOES NOT OPERATE PROPERLY**

TEST STEP	ACTION TO TAKE
<ul style="list-style-type: none"> <li>With key ON, measure the voltage between pin 1 (LB wire), pin 12 (LB wire) on instrument cluster C215 and ground.</li> <li><b>Is the voltage greater than 10 volts?</b></li> </ul>	Yes = GO to <b>Y6</b> . No = REPAIR the LB wire(s) in question.
<b>Y6 CHECK CIRCUIT 627 (BK/O) FOR OPEN</b> <ul style="list-style-type: none"> <li>With key OFF, disconnect GEM C221 and measure the resistance of the BK/O wire between pin 9 on instrument cluster C215 and pin 9 on GEM C221.</li> <li><b>Is the resistance less than 5 ohms?</b></li> </ul>	Yes = GO to <b>Y7</b> . No = REPAIR the BK/O wire.
<b>Y7 CHECK CIRCUIT 627 (BK/O) FOR SHORT TO GROUND</b> <ul style="list-style-type: none"> <li>With key OFF, measure the resistance between pin 9 (BK/O wire) on instrument cluster C215 and ground.</li> <li><b>Is the resistance greater than 10,000 ohms?</b></li> </ul>	Yes = REPLACE the GEM. REFER to <b>Section 419-10 of the 2001 Ranger Workshop Manual</b> . CLEAR the DTCs. No = REPAIR the BK/O wire.
<b>Y8 CHECK DOOR AJAR INDICATOR CONTROL CIRCUIT FOR SHORT TO POWER</b> <ul style="list-style-type: none"> <li>With key OFF, disconnect instrument cluster C215.</li> <li>With key ON, measure the voltage between pin 9 (BK/O wire) on instrument cluster C215 and ground.</li> <li><b>Is the voltage greater than 0 volts?</b></li> </ul>	Yes = GO to <b>Y9</b> . No = REPLACE the instrument cluster.
<b>Y9 CHECK CIRCUIT 627 (BK/O) FOR SHORT TO POWER</b> <ul style="list-style-type: none"> <li>With key OFF, disconnect GEM C221.</li> <li>With key ON, measure the voltage between pin 9 (BK/O wire) on instrument cluster C215 and ground.</li> <li><b>Is the voltage greater than 0 volts?</b></li> </ul>	Yes = REPAIR the BK/O wire. No = REPLACE the GEM; REFER to <b>Section 419-10 of the 2001 Ranger Workshop Manual</b> .

**PINPOINT TEST Z: SEAT BELT INDICATOR DOES NOT OPERATE PROPERLY**

TEST STEP	ACTION TO TAKE
<b>Z1 CHECK IGNITION SWITCH STATES</b> <ul style="list-style-type: none"> <li>Use New Generation STAR (NGS) Tester to monitor the PID IGN_GEM while turning the ignition switch through the START, RUN, OFF, and ACC positions.</li> <li><b>Do the PID values agree with the ignition switch position?</b></li> </ul>	Yes = GO to <b>Z2</b> . No = REFER to <b>Section 417-02 of the 2001 Ranger Workshop Manual</b> .
<b>Z2 RETRIEVE DIAGNOSTIC TROUBLE CODES (DTCs)</b> <ul style="list-style-type: none"> <li>Retrieve and document continuous DTCs, clear continuous DTCs, and carry out on-demand self-test.</li> <li><b>Are any DTCs recorded?</b></li> </ul>	Yes = If DTC B1426, GO to <b>Z9</b> . If DTC B1428, GO to <b>Z3</b> . If DTCs B1430 and B1462, REFER to <b>Section 413-09 of the 2001 Workshop Manual</b> . If DTC B1342, REPLACE the GEM; REFER to <b>Section 419-10 of the 2001 Ranger Workshop Manual</b> . CLEAR the DTCs. No = GO to <b>Z3</b> .
<b>Z3 VERIFY SEAT BELT WARNING CHIME OPERATION</b>	

(Continued)

**DIAGNOSIS AND TESTING (Continued)****PINPOINT TEST Z: SEAT BELT INDICATOR DOES NOT OPERATE PROPERLY**

TEST STEP	ACTION TO TAKE
<ul style="list-style-type: none"> <li>• With key ON, verify the seat belt warning chime operation.</li> <li>• <b>Does the seat belt warning chime operate?</b></li> </ul>	Yes = GO to <b>Z4</b> . No = REFER to <b>Section 413-09 of the 2001 Ranger Workshop Manual</b> .
<b>Z4 CHECK PID SBLTLMP WHILE TOGGLING ACTIVE COMMAND SBLT LAMP</b> <ul style="list-style-type: none"> <li>• Monitor the PID SBLTLMP.</li> <li>• Toggle the active command SBLT LAMP ON and OFF.</li> <li>• <b>Does the PID SBLTLMP agree with the active command mode?</b></li> </ul>	Yes = REPLACE the GEM; REFER to <b>Section 419-10 of the 2001 Ranger Workshop Manual</b> . CLEAR the DTCs. No = If the PID SBLTLMP reads OFF O-G, GO to <b>Z5</b> . If the PID SBLTLMP reads ON -B-, GO to <b>Z9</b> .
<b>Z5 CHECK INSTRUMENT CLUSTER</b> <ul style="list-style-type: none"> <li>• With key OFF, disconnect instrument cluster C216.</li> <li>• With key OFF, measure the resistance between instrument cluster printed circuit C216 terminal 4 and terminal 10.</li> <li>• <b>Is the resistance less than 5 ohms?</b></li> </ul>	Yes = GO to <b>Z6</b> . No = CHECK the seat belt indicator bulb. REPLACE if necessary. If the bulb is OK, REPLACE the instrument cluster.
<b>Z6 CHECK POWER TO INSTRUMENT CLUSTER</b> <ul style="list-style-type: none"> <li>• With key ON, measure the voltage between pin 4 (Y wire) on instrument cluster C216 and ground.</li> <li>• <b>Is the voltage greater than 10 volts?</b></li> </ul>	Yes = GO to <b>Z7</b> . No = REPAIR the Y wire.
<b>Z7 CHECK CIRCUIT 871 (Y) FOR OPEN</b> <ul style="list-style-type: none"> <li>• With key OFF, disconnect GEM C221 and measure the resistance of the Y wire between pin 10 on instrument cluster C216 and pin 12 on GEM C221.</li> <li>• <b>Is the resistance less than 5 ohms?</b></li> </ul>	Yes = GO to <b>Z8</b> . No = REPAIR the Y wire.
<b>Z8 CHECK CIRCUIT 871 (Y) FOR SHORT TO GROUND</b> <ul style="list-style-type: none"> <li>• With key OFF, measure the resistance between pin 10 (Y wire) on instrument cluster C216 and ground.</li> <li>• <b>Is the resistance greater than 10,000 ohms?</b></li> </ul>	Yes = REPLACE the GEM. REFER to <b>Section 419-10 of the 2001 Ranger Workshop Manual</b> . CLEAR the DTCs. No = REPAIR the Y wire.
<b>Z9 CHECK SEAT BELT INDICATOR CONTROL CIRCUIT FOR SHORT TO POWER</b> <ul style="list-style-type: none"> <li>• With key OFF, disconnect instrument cluster C216.</li> <li>• With key ON, measure the voltage between pin 10 (Y wire) on instrument cluster C216 and ground.</li> <li>• <b>Is the voltage greater than 0 volts?</b></li> </ul>	Yes = GO to <b>Z10</b> . No = REPLACE the instrument cluster.
<b>Z10 CHECK CIRCUIT 871 (Y) FOR SHORT TO POWER</b> <ul style="list-style-type: none"> <li>• With key OFF, disconnect GEM C221.</li> <li>• With key ON, measure the voltage between pin 10 (Y wire) on instrument cluster C216 and ground.</li> <li>• <b>Is the voltage greater than 0 volts?</b></li> </ul>	Yes = REPAIR the Y wire. No = REPLACE the GEM; REFER to <b>Section 419-10 of the 2001 Ranger Workshop Manual</b> .

## REMOVAL AND INSTALLATION

### Instrument Cluster —Postal Ranger EV

#### Removal and Installation

1. Disconnect the auxiliary battery ground cable.
2. Remove the eight instrument panel screws.

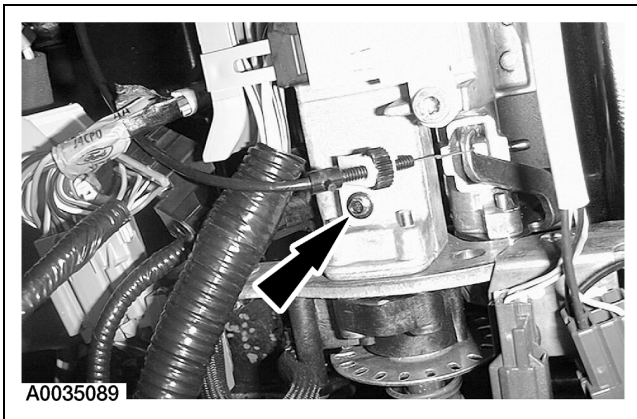
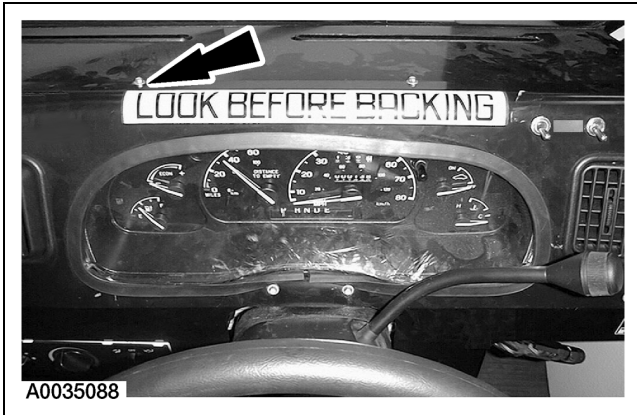

3. Remove the bolt, disconnect the gear indicator cable and position aside.

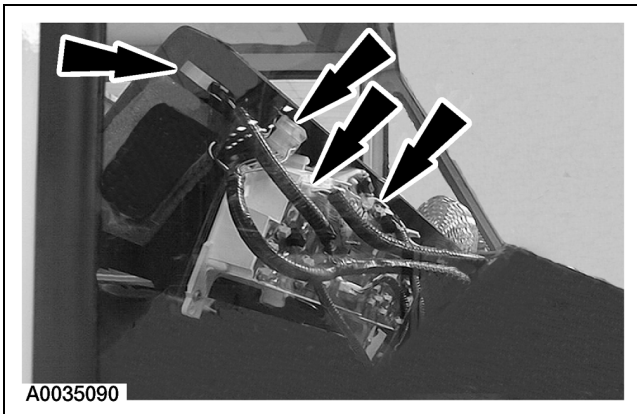

4. **NOTE:** Only four connectors are shown. Disconnect all of the electrical connectors and remove the instrument cluster.

## REMOVAL AND INSTALLATION (Continued)

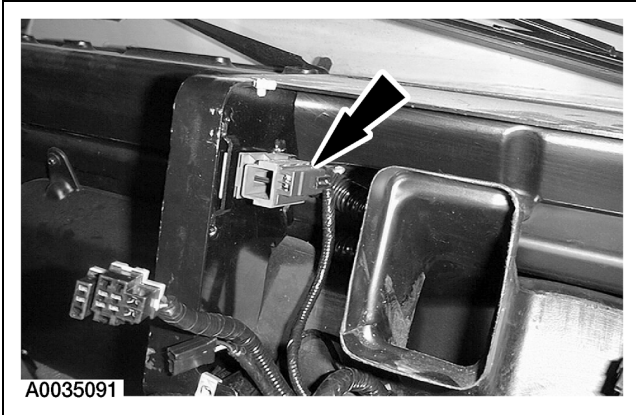

5. Disconnect the electrical connector.

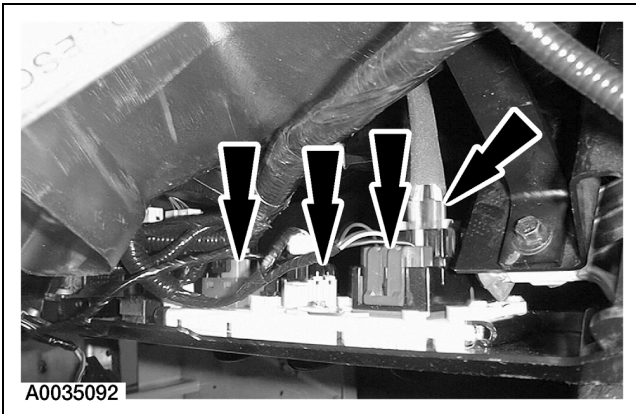

6. Disconnect the heater control electrical and vacuum connectors.

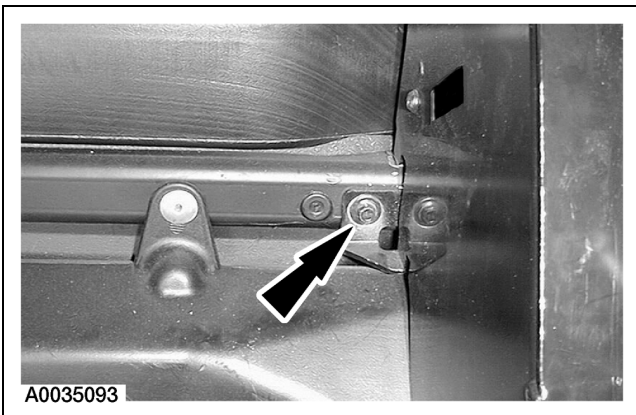

7. Remove the bolt.

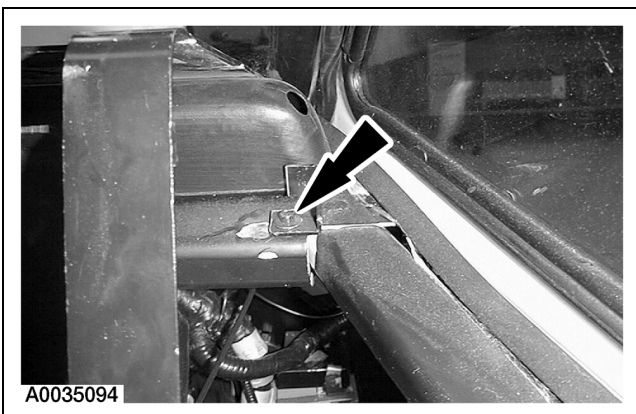

8. **NOTE:** The foam seal around the RH register vent may come off with the instrument panel. If this happens, install a new foam seal.  
Remove the bolt and the instrument panel assembly.

---

**REMOVAL AND INSTALLATION (Continued)**

9. To install, reverse the removal procedure.
  - Make sure the register vents move properly side to side after installation.



---

 Manual Table of Contents

## SECTION 414-02 Auxiliary Battery Charging

VEHICLE APPLICATION: Ranger EV

CONTENTS	PAGE
<b>SPECIFICATIONS</b> .....	414-02-2
<b>DESCRIPTION AND OPERATION</b>	
Auxiliary Battery Charging .....	414-02-2
<b>DIAGNOSIS AND TESTING</b>	
Auxiliary Battery Charging .....	414-02-2
Electrical Schematic .....	414-02-3
Inspection and Verification .....	414-02-3
Pinpoint Tests .....	414-02-4
Symptom Chart .....	414-02-3
<b>GENERAL PROCEDURES</b>	
Auxiliary Battery Capacity Test .....	414-02-8
Auxiliary Battery Charging .....	414-02-8
<b>REMOVAL AND INSTALLATION</b>	
DC/DC Converter .....	414-02-9

## SPECIFICATIONS

### Torque Specifications

Description	Nm	Lb-In
Cable Nuts	12	107
Direct Current to Direct Current (DC/DC) Hold-Down Bolts	9	80.5

(Continued)

### Torque Specifications

Description	Nm	Lb-In
Ground Strap Nut	12	107
High Voltage Power Distribution Box (HVPDB) Screws	2	18

## DESCRIPTION AND OPERATION

### Auxiliary Battery Charging

The charging of the auxiliary battery is done by the direct current to direct current (DC/DC) converter, which operates as an electrical alternator. The converter is located under the hood on the driver side of the traction battery charger. The auxiliary battery temperature sensor is located next to the auxiliary battery to monitor the battery temperature. Activation of the DC/DC converter is controlled by the interface adapter assembly (IAA) module, which operates the DC/DC converter whenever the key is in the ON position or when the vehicle is connected to the power control station (PCS).

The DC/DC converter is capable of supplying up to 100 amps of current for operation of the vehicle's 12-volt systems. Voltage from the traction battery is stepped down to the 12 volts required for low-voltage system operation, such as the blower motor, radio, and wipers. Heavy current demands cause the DC/DC converter to produce heat, which is removed by the coolant that is circulated through the DC/DC converter.

## DIAGNOSIS AND TESTING

### Auxiliary Battery Charging

#### Diagnostic Trouble Code (DTC) Definition

The following DTCs relate to the Auxiliary Battery Charging System:

- DTC B1317 Battery Voltage - High
  - The interface adapter assembly (IAA) module monitors the auxiliary battery voltage at pins 75, 76 (hot at all times). If the auxiliary battery voltage increases above 16.5 volts, the IAA module generates DTC B1317, disables the direct current to direct current (DC/DC) converter, and enters a self-protecting state similar to sleep mode. The IAA module will reenables the DC/DC converter when the auxiliary battery voltage decreases below 16.25 volts.

**DIAGNOSIS AND TESTING (Continued)**

- DTC B1318 Battery Voltage - Low

— The interface adapter assembly (IAA) module monitors the auxiliary battery voltage at pins 75, 76 (hot at all times). If the auxiliary battery voltage decreases below 10 volts, the IAA module generates DTC B1318 and enters a limited operating mode where it will attempt to close the auxiliary contactor relay and reenables the direct current to direct current (DC/DC) converter. If the auxiliary contactor relay is already closed and the DC/DC converter is already enabled, they will remain so. As the auxiliary voltage continues to decrease, the IAA module will continue to try to run the DC/DC converter as long as possible. The vacuum system will remain active until the auxiliary battery voltage drops below 9 volts. The IAA module will shut down below 9 volts.

- DTC C1775 DC/DC Converter Failure

— The interface adapter assembly (IAA) module monitors the auxiliary battery voltage at pins 75, 76 (hot at all times). If the IAA module senses the auxiliary battery voltage is too high for more than 250 milliseconds, it will begin to isolate the reason for the increase. This strategy may include up to five attempts to enable the direct current to direct current (DC/DC) converter at 30-second intervals. The IAA module may also open the auxiliary contactor relay. If the IAA module suspects the DC/DC converter is supporting the auxiliary battery voltage too high (more than 16.5 volts) when commanded off, DTC C1775 is generated. The IAA module also generates DTC C1775 when the auxiliary battery voltage decreases below 11.5 volts and the DC/DC converter is not indicating an overcurrent (current limit) condition.

**Electrical Schematic**

Refer to **Electrical and Vacuum Troubleshooting Manual, Cell 12, Auxiliary Battery Charging System and Cell 13, Power Distribution (High Voltage)** for schematic and connector information.

**Inspection and Verification**

Refer to [Section 100-07](#).

**Symptom Chart****Symptom Chart**

Condition	Possible Sources	Action
<ul style="list-style-type: none"> <li>• DTC B1317 Battery Voltage - High</li> </ul>	<ul style="list-style-type: none"> <li>• Circuit(s).</li> <li>• Auxiliary battery temperature sensor.</li> <li>• Direct current to direct current (DC/DC) converter.</li> </ul>	<ul style="list-style-type: none"> <li>• GO to Pinpoint Test A.</li> </ul>
<ul style="list-style-type: none"> <li>• DTC B1318 Battery Voltage - Low</li> </ul>	<ul style="list-style-type: none"> <li>• Circuit(s).</li> <li>• Auxiliary battery temperature sensor.</li> <li>• Direct current to direct current (DC/DC) converter.</li> </ul>	<ul style="list-style-type: none"> <li>• GO to Pinpoint Test B.</li> </ul>

**DIAGNOSIS AND TESTING (Continued)****Symptom Chart (Continued)**

Condition	Possible Sources	Action
<ul style="list-style-type: none"> <li>DTC C1775 DC/DC Converter Failure</li> </ul>	<ul style="list-style-type: none"> <li>Circuit(s).</li> <li>MEGA fuse.</li> <li>Auxiliary battery cables.</li> <li>Direct current to direct current (DC/DC) converter.</li> <li>Interface adapter assembly (IAA) module.</li> <li>High voltage power distribution box (HVPDB).</li> <li>High-voltage DC/DC fuse.</li> </ul>	<ul style="list-style-type: none"> <li>GO to Pinpoint Test C.</li> </ul>
<ul style="list-style-type: none"> <li>Auxiliary Battery Warning Indicator Illuminated (Auxiliary Battery Temperature Sensor Failure)</li> </ul>	<ul style="list-style-type: none"> <li>Circuit(s).</li> <li>Direct current to direct current (DC/DC) converter.</li> <li>Auxiliary battery temperature sensor.</li> </ul>	<ul style="list-style-type: none"> <li>GO to Pinpoint Test D.</li> </ul>

**Pinpoint Tests****Special Tool(s)**

104-Pin Breakout Box (BOB) 418-049 (014-00950) or equivalent
High Voltage Insulated Safety Gloves 100-F036 or equivalent
Face Shield 100-F035 or equivalent

**PINPOINT TEST A: DTC B1317 BATTERY VOLTAGE - HIGH**

TEST STEP	ACTION TO TAKE
<b>A1 CHECK FOR DC/DC CONVERTER FAILURE DIAGNOSTIC TROUBLE CODE (DTC)</b> <ul style="list-style-type: none"> <li>Carry out on-demand self-test for the interface adapter assembly (IAA) module and check for DTC C1775 DC/DC Converter Failure.</li> <li><b>Did DTC C1775 DC/DC Converter Failure occur?</b></li> </ul>	Yes = GO to Pinpoint Test C. No = GO to <b>A2</b> .
<b>A2 CHECK AUXILIARY BATTERY VOLTAGE</b> <ul style="list-style-type: none"> <li>With key ON, monitor the IAA module PID VBATIAA.</li> <li><b>Is the voltage greater than 14 volts?</b></li> </ul>	Yes = GO to Pinpoint Test D. No = System OK. CHECK wiring for intermittent connections.

**PINPOINT TEST B: DTC C1318 BATTERY VOLTAGE - LOW**

TEST STEP	ACTION TO TAKE
<b>B1 CHECK FOR OTHER INTERFACE ADAPTER ASSEMBLY (IAA) MODULE DIAGNOSTIC TROUBLE CODES (DTCs)</b> <ul style="list-style-type: none"> <li>Carry out on-demand self-test for the IAA module and check for IAA module DTCs.</li> <li><b>Did other IAA module DTCs occur?</b></li> </ul>	Yes = REFER to IAA Module Diagnostic Trouble Code (DTC) Index in <a href="#">Section 100-07</a> . No = GO to <b>B2</b> .
<b>B2 CHECK AUXILIARY BATTERY VOLTAGE</b> <ul style="list-style-type: none"> <li>With key ON, monitor the IAA module PID VBATIAA.</li> <li><b>Is the voltage less than 13.4 volts?</b></li> </ul>	Yes = GO to Pinpoint Test D. No = System OK. CHECK wiring for intermittent connections.

**DIAGNOSIS AND TESTING (Continued)****PINPOINT TEST C: DTC C1775 DC/DC CONVERTER FAILURE**

TEST STEP	ACTION TO TAKE
<p><b>C1 CHECK DC/DC CONVERTER OPERATION</b></p> <p><b>NOTE:</b> Before proceeding, verify the power control station (PCS) is not plugged into the vehicle and all accessories (radio, A/C, heater, etc.) are turned off. If the New Generation STAR (NGS) Tester indicates UNABLE TO PERFORM TEST/FUNCTION and MODULE NOT RESPONDING for the interface adapter assembly (IAA) module when attempting to monitor the IAA module PID VBATIAA, measure the voltage of the auxiliary battery. If the voltage is less than 11 volts, recharge the auxiliary battery. Refer to General Procedures in this section.</p> <ul style="list-style-type: none"> <li>• With key OFF, monitor the IAA module PID VBATIAA.</li> <li>• While monitoring the IAA module PID VBATIAA, turn the ignition key to the ON position.</li> <li>• <b>Does the VBATIAA PID increase from approximately 12.5 volts to approximately 13.7 volts?</b></li> </ul>	<p>Yes = System OK. CHECK wiring for intermittent connections.</p> <p>No = GO to C2.</p>
<p><b>C2 CHECK DC/DC CONVERTER OPERATION USING NGS ACTIVE COMMAND</b></p> <ul style="list-style-type: none"> <li>• Enter the IAA module active command mode AUXILIARY SYSTEM CONTROL, monitor the IAA module PID VBATIAA, and set the active command SUPPT SLI to YES.</li> <li>• <b>Is the voltage indicated by the VBATIAA PID between 13.4 and 13.8 volts?</b></li> </ul>	<p>Yes = System OK. CHECK wiring for intermittent connections.</p> <p>No = GO to C3.</p>
<p><b>C3 CHECK AUXILIARY CONTACTOR RELAY STATUS</b></p> <ul style="list-style-type: none"> <li>• With key ON, monitor the IAA module PID AUX__HVC.</li> <li>• <b>Does the AUX__HVC PID indicate CLOSED?</b></li> </ul>	<p>Yes = GO to C4.</p> <p>No = CARRY OUT pinpoint test for IAA DTC C1862 Contactor Circuit Failure. REFER to Auxiliary Contactor Relay Control in <a href="#">Section 414-03A</a> or <a href="#">Section 414-03B</a>.</p>
<p><b>C4 CHECK MEGA FUSE</b></p> <ul style="list-style-type: none"> <li>• With key OFF, measure the resistance of the 175A MEGA fuse attached to the electric vehicle power distribution box (EVPDB).</li> <li>• <b>Is the resistance less than 5 ohms?</b></li> </ul>	<p>Yes = GO to C6.</p> <p>No = REPLACE the MEGA fuse. GO to C5.</p>
<p><b>C5 CHECK POSITIVE BATTERY CABLES FOR SHORT(S) TO GROUND</b></p> <ul style="list-style-type: none"> <li>• With key OFF, disconnect the cables from the auxiliary battery, and measure the resistance between the positive and negative auxiliary battery cables.</li> <li>• With key OFF, disconnect the positive battery cable from the DC/DC converter and measure the resistance between the positive cable on the MEGA fuse stud and the negative auxiliary battery post.</li> <li>• <b>Are the resistances greater than 10,000 ohms?</b></li> </ul>	<p>Yes = REPLACE the DC/DC converter.</p> <p>No = REPLACE the positive cable(s) in question.</p>
<p><b>C6 CHECK IAA MODULE DC/DC CONVERTER ENABLE SIGNAL</b></p> <ul style="list-style-type: none"> <li>• Connect 104-Pin Breakout Box (BOB) to the IAA module and IAA module C1945.</li> <li>• With key ON, measure the voltage between BOB pin 100 and ground (BOB pin 80).</li> <li>• <b>Is the voltage greater than 10 volts?</b></li> </ul>	<p>Yes = GO to C7.</p> <p>No = GO to C8.</p>
<p><b>C7 CHECK CIRCUIT 3259 (Y/BK) FOR SHORT TO POWER</b></p> <ul style="list-style-type: none"> <li>• With key OFF, disconnect the IAA module from the BOB; leave the BOB connected to IAA module C1945.</li> </ul>	<p>Yes = REPAIR the Y/BK wire.</p>

(Continued)



**DIAGNOSIS AND TESTING (Continued)****PINPOINT TEST C: DTC C1775 DC/DC CONVERTER FAILURE**

TEST STEP	ACTION TO TAKE
<ul style="list-style-type: none"> <li>Measure the resistance between circuit 3117 (DB wire) and circuit 3118 (W wire) on HVPDB DC/DC converter C1914F.</li> <li><b>Is the resistance greater than 10,000 ohms?</b></li> </ul>	Yes = GO to <b>C14</b> . No = REPLACE the HVPDB. REFER to <a href="#">Section 414-03A</a> or <a href="#">Section 414-03B</a> .
<b>C14 CHECK SYSTEM</b> <ul style="list-style-type: none"> <li>With key OFF, reconnect all component connectors that were disconnected.</li> <li>Reconnect the 12-volt auxiliary battery negative cable.</li> <li>Key ON.</li> <li><b>Does the 10A DC/DC high-voltage fuse fail again?</b></li> </ul>	Yes = REPLACE the DC/DC converter. REPLACE the 10A DC/DC fuse. REFER to <a href="#">Section 414-03A</a> or <a href="#">Section 414-03B</a> . No = System OK.

**PINPOINT TEST D: AUXILIARY BATTERY WARNING INDICATOR ILLUMINATED (AUXILIARY BATTERY TEMPERATURE SENSOR FAILURE)**

TEST STEP	ACTION TO TAKE
<b>D1 CHECK DC/DC CONVERTER OPERATION</b> <b>NOTE:</b> Before proceeding, verify the power control station (PCS) is not plugged into the vehicle and all accessories (radio, A/C, heater, etc.) are turned off. <ul style="list-style-type: none"> <li>With key OFF, monitor the IAA module PID VBATIAA.</li> <li>While monitoring the IAA module PID VBATIAA, turn the ignition key to the ON position.</li> <li><b>Does the VBATIAA PID increase to approximately 13.7 volts?</b></li> </ul>	Yes = System OK. CARRY OUT instrument cluster diagnosis. REFER to <a href="#">Section 413-01</a> . No = GO to <b>D2</b> .
<b>D2 CHECK DC/DC CONVERTER</b> <ul style="list-style-type: none"> <li>With key OFF, disconnect auxiliary battery temperature sensor C1953.</li> <li>With key ON, monitor IAA module PID VBATIAA. Voltage should be between 12.8 and 13.0 volts.</li> <li>Connect a jumper wire between the DG/P wire and Y/R wire on auxiliary battery temperature sensor C1953. Voltage should be between 14.6 and 15.1 volts.</li> <li><b>Does the voltage increase as indicated when auxiliary battery temperature sensor C1953 is jumpered?</b></li> </ul>	Yes = GO to <b>D6</b> . No = GO to <b>D3</b> .
<b>D3 CHECK CIRCUITS 3223 (Y/R) AND 3224 (DG/P) FOR OPEN(S)</b> <ul style="list-style-type: none"> <li>With key OFF, disconnect DC/DC converter C1943 and measure the resistance of the Y/R wire between auxiliary temperature sensor C1953 and pin 1 on DC/DC converter C1943.</li> <li>With key OFF, measure the resistance of the DG/P wire between auxiliary battery temperature sensor and pin 2 on DC/DC converter C1943.</li> <li><b>Are the resistances less than 5 ohms?</b></li> </ul>	Yes = GO to <b>D4</b> . No = REPAIR the wire(s) in question.
<b>D4 CHECK CIRCUITS 3223 (Y/R) AND 3224 (DG/P) FOR SHORT(S) TO GROUND</b> <ul style="list-style-type: none"> <li>With key OFF, measure the resistance between Y/R wire, DG/P wire on auxiliary temperature sensor C1953 and ground.</li> <li><b>Are the resistances greater than 10,000 ohms?</b></li> </ul>	Yes = GO to <b>D5</b> . No = REPAIR the wire(s) in question.
<b>D5 CHECK CIRCUITS 3223 (Y/R) AND 3224 (DG/P) FOR SHORT(S) TO POWER</b>	

(Continued)

**DIAGNOSIS AND TESTING (Continued)****PINPOINT TEST D: AUXILIARY BATTERY WARNING INDICATOR ILLUMINATED (AUXILIARY BATTERY TEMPERATURE SENSOR FAILURE)**

TEST STEP	ACTION TO TAKE
<ul style="list-style-type: none"> <li>With key ON, measure the voltage between Y/R wire, DG/P wire on auxiliary temperature sensor C1953 and ground.</li> <li><b>Are any of the voltages greater than 0 volts?</b></li> </ul>	Yes = REPAIR the wire(s) in question. No = REPLACE the DC/DC converter.
<b>D6 CHECK AUXILIARY BATTERY TEMPERATURE SENSOR</b> <ul style="list-style-type: none"> <li>With key OFF, reconnect auxiliary battery temperature sensor C1953.</li> <li>With key ON, monitor IAA module PIDs EXT__UT2 and VBATIAA and compare the readings to the values below:  <b>Temperature</b> <ul style="list-style-type: none"> <li>—0 °C (32°F) = 14.1-14.7 volts</li> <li>—5 °C (41°F) = 14.0-14.6 volts</li> <li>—10 °C (50°F) = 13.9-14.5 volts</li> <li>—15 °C (59°F) = 13.8-14.4 volts</li> <li>—20 °C (68°F) = 13.7-14.3 volts</li> <li>—25 °C (77°F) = 13.6-14.3 volts</li> <li>—30 °C (86°F) = 13.5-14.2 volts</li> <li>—35 °C (95°F) = 13.4-14.2 volts</li> <li>—40 °C (104°F) = 13.3-14.1 volts</li> <li>—45 °C (113°F) = 13.3-14.0 volts</li> <li>—50 °C (122°F) = 13.3-13.9 volts</li> <li>—55 °C (131°F) = 13.3-13.8 volts</li> <li>—60 °C (140°F) = 13.3-13.8 volts</li> </ul> </li> <li><b>Is the voltage OK?</b></li> </ul>	Yes = System OK. CHECK wiring for intermittent connections. No = REPLACE the auxiliary battery temperature sensor.

**GENERAL PROCEDURES****Auxiliary Battery Charging**

- For additional information, refer to **2001 Ranger Workshop Manual Section 414-00**.

**Auxiliary Battery Capacity Test**

- For additional information, refer to **2001 Ranger Workshop Manual Section 414-00**.



## REMOVAL AND INSTALLATION

### DC/DC Converter

#### Removal

1. Disconnect the traction battery high-voltage 2-pin connector. Refer to [Section 100-05](#).

2.  **WARNING: Do not remove the radiator pressure relief cap if the coolant is hot or if the pump is running.**

Turn the radiator pressure relief cap to the first stop to relieve any remaining pressure.

3. Remove the high voltage power distribution Box (HVPDB) cover.
  - 1 Remove the screws.
  - 2 Remove the cover.

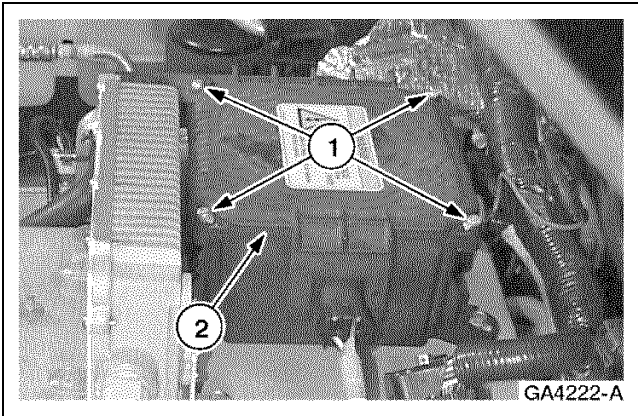

4. Disconnect the direct current to direct current (DC/DC) converter electrical connectors.
  - 1 Remove the ground strap nut.
  - 2 Disconnect the cable connector.
  - 3 Disconnect the electrical connector.
    - Unclip the harness.

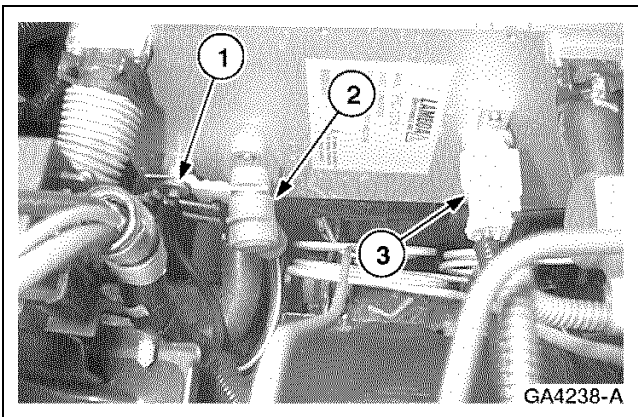

## REMOVAL AND INSTALLATION (Continued)

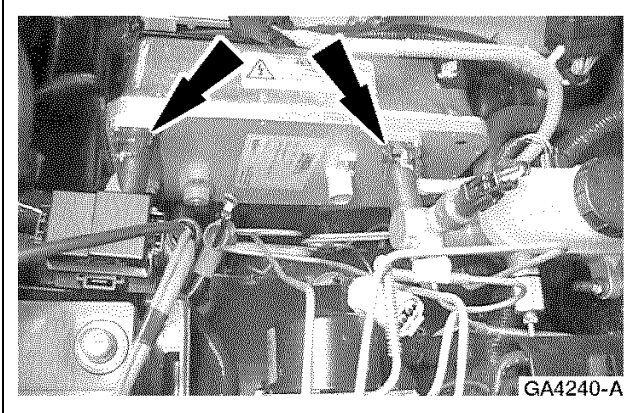

5. Clamp off and disconnect the coolant lines at the DC/DC converter.

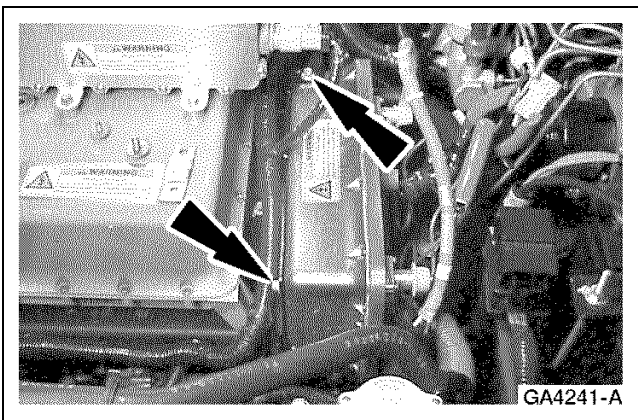

6. Remove the hold-down bolts and remove the converter.

### Installation

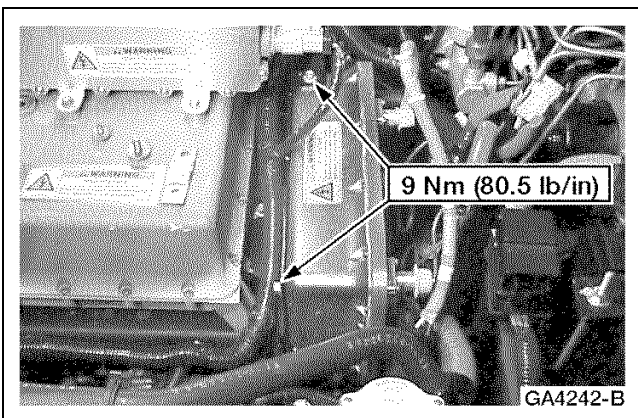

1. **NOTE:** There are two locating tabs on the lower back side of the DC/DC converter. These tabs locate and hold the converter in the card table.

Position the DC/DC converter in the card table and install the bolts.

## REMOVAL AND INSTALLATION (Continued)

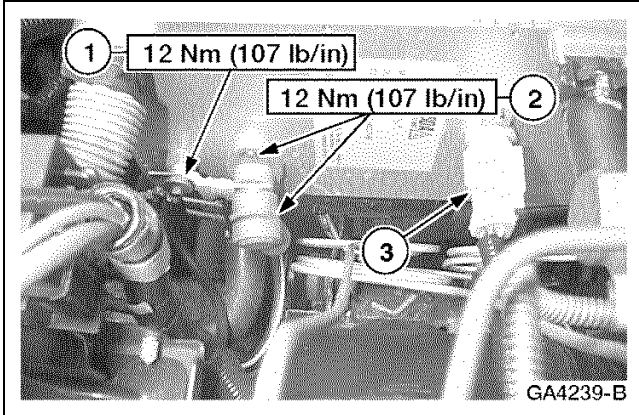

2. Connect the DC/DC converter electrical connectors.
  - 1 Position the electrical cross bar and install the ground strap nut.
  - 2 Position the cable and install the nuts.
  - 3 Connect the electrical connector.

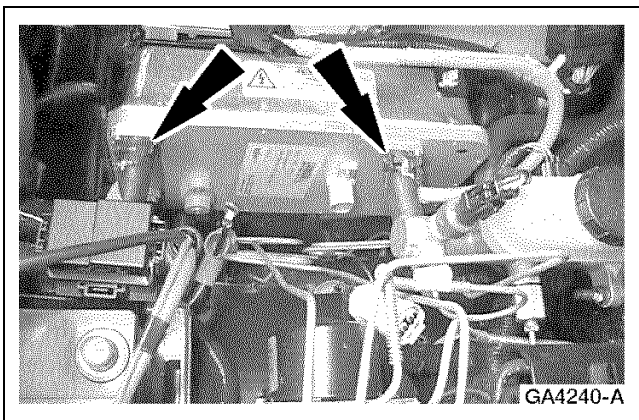

3. Connect the DC/DC converter coolant lines.

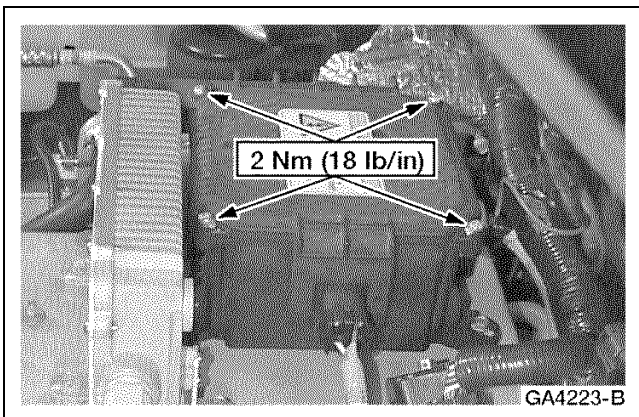

4. Install the HVPDB cover.
  - Install the screws.

5. Connect the traction battery high-voltage 2-pin connector. Refer to [Section 100-05](#).
6. Bleed the cooling system. Refer to [Section 303-03](#).

---

 Manual Table of Contents

## SECTION 414-03A High Voltage/Traction Battery

VEHICLE APPLICATION: Ranger EV

CONTENTS	PAGE
<b>SPECIFICATIONS</b> .....	414-03A-3
<b>DESCRIPTION AND OPERATION</b>	
High Voltage/Traction Battery .....	414-03A-3
<b>DIAGNOSIS AND TESTING</b>	
Auxiliary Contactor Relay Control .....	414-03A-5
Electrical Schematic .....	414-03A-5
Inspection and Verification .....	414-03A-5
Pinpoint Tests .....	414-03A-5
Symptom Chart .....	414-03A-5
Contactor Box Current Sensors .....	414-03A-22
Electrical Schematic .....	414-03A-22
Inspection and Verification .....	414-03A-22
Pinpoint Tests .....	414-03A-23
Symptom Chart .....	414-03A-23
Current Leakage Detection .....	414-03A-26
Electrical Schematic .....	414-03A-26
Inspection and Verification .....	414-03A-26
Pinpoint Tests .....	414-03A-27
Symptom Chart .....	414-03A-27
Emergency Power Off (EPO)/Interlock System .....	414-03A-18
Electrical Schematic .....	414-03A-18
Inspection and Verification .....	414-03A-18
Pinpoint Tests .....	414-03A-19
Symptom Chart .....	414-03A-19
Main/Precharge Contactor Relay Control .....	414-03A-10
Electrical Schematic .....	414-03A-10
Inspection and Verification .....	414-03A-10
Pinpoint Tests .....	414-03A-11
Symptom Chart .....	414-03A-11
Multiple Auxiliary Load Failure Diagnosis .....	414-03A-79
Electrical Schematic .....	414-03A-79
Inspection and Verification .....	414-03A-79
Pinpoint Tests .....	414-03A-80
Symptom Chart .....	414-03A-80
Negative Contactor Relay Control .....	414-03A-16
Electrical Schematic .....	414-03A-16
Inspection and Verification .....	414-03A-16
Pinpoint Tests .....	414-03A-16
Symptom Chart .....	414-03A-16
Regenerative Braking .....	414-03A-40
Electrical Schematic .....	414-03A-40
Inspection and Verification .....	414-03A-40
Pinpoint Tests .....	414-03A-41
Symptom Chart .....	414-03A-41
Traction Battery Charging/Heating System .....	414-03A-43
Electrical Schematic .....	414-03A-45
Inspection and Verification .....	414-03A-45

<b>CONTENTS</b>	<b>PAGE</b>
Pinpoint Tests.....	414-03A-46
Symptom Chart.....	414-03A-45
Traction Battery Cooling/Ventilation System.....	414-03A-65
Electrical Schematic.....	414-03A-65
Inspection and Verification.....	414-03A-65
Pinpoint Tests.....	414-03A-65
Symptom Chart.....	414-03A-65
Traction Battery System.....	414-03A-68
Battery Module Diagnostic Test.....	414-03A-68
Electrical Schematic.....	414-03A-70
Inspection and Verification.....	414-03A-70
Pinpoint Tests.....	414-03A-71
Symptom Chart.....	414-03A-70
<b>GENERAL PROCEDURES</b>	
Battery Tray Seal.....	414-03A-97
Module Charging.....	414-03A-81
Traction Battery Module Replacement.....	414-03A-82
Traction Battery Tray Repair.....	414-03A-93
<b>REMOVAL AND INSTALLATION</b>	
Battery Control Module (BCM).....	414-03A-98
Charge Inlet.....	414-03A-101
Contactors Box.....	414-03A-103
Contactors Box Fuses.....	414-03A-107
HVPDB Fuses.....	414-03A-109
High Voltage Power Distribution Box (HVPDB).....	414-03A-111
High Voltage Wiring.....	414-03A-117
High Voltage Wiring —Sensory Lead Harness (10B694).....	414-03A-112
Traction Battery.....	414-03A-120
Traction Battery Charger.....	414-03A-125
Traction Battery Cooling/Ventilation Fan.....	414-03A-128
Traction Battery Heating Elements (U/L) —Lower.....	414-03A-130
Traction Battery Heating Elements (U/L) —Upper.....	414-03A-130
Traction Battery High Voltage Fuse (250A).....	414-03A-131
Traction Battery Module —Modules 1-7.....	414-03A-133
Traction Battery Module —Modules 12-15, 28-31.....	414-03A-138
Traction Battery Module —Modules 16, 25-27.....	414-03A-139
Traction Battery Module —Modules 17-18.....	414-03A-134
Traction Battery Module —Modules 19-21.....	414-03A-134
Traction Battery Module —Modules 22-24.....	414-03A-140
Traction Battery Module —Modules 34-39.....	414-03A-136
Traction Battery Module —Modules 8-11.....	414-03A-135
Traction Battery Temperature Sensor —Modules 22-24.....	414-03A-142
<b>DISASSEMBLY AND ASSEMBLY</b>	
Traction Battery Temperature Sensor.....	414-03A-144

## SPECIFICATIONS

### Torque Specifications

Description	Nm	Lb-Ft	Lb-In
A/C Inverter Motor Control Bolts	12	—	107
Battery Control Module Multi-Pin Connector Bolts	3	—	27
Blower Motor Relay Screw	3	—	27
Blower Bracket to Cross Bar Bolts	10	—	89
Charger Inlet Bracket Bolts	7	—	62.5
Contactors Box Screws	2	—	18
Cross Bar to Battery Tray Nuts	5	—	44.5
Crossbar to Traction Battery Fan Nuts and Bolts	10	—	89
Grille Screws	1.5	—	13.5
Ground Strap Bolt	12	—	107
Harness Bracket Bolt	5.4	—	48
High-Voltage Fuse Bolts	12	—	107
High-Voltage Fuse Bracket Nut	5	—	44.5
High-Voltage Harness Bracket Bolt	5.5	—	49
High-Voltage Jumper to Battery Module Nuts	12	—	107

(Continued)

### Torque Specifications

Description	Nm	Lb-Ft	Lb-In
High-Voltage Power Distribution Box Bolts	12	—	107
High-Voltage Power Distribution Box Cover Screws	2	—	18
High-Voltage Power Distribution Box Fuse Safety Cover Screws	2	—	18
Traction Battery Charger Bolts	22	16	—
Traction Battery Cooling Fan Screws	4	—	35.5
Traction Battery Cover Bolts	17	12.5	—
Traction Battery Mounting Bolts	126	92.5	—
Two-Pin High-Voltage Connector Nuts	5	—	44.5
76-Pin Connector Bolt	4.8	—	43

### General Specifications

Item	Specification
Loctite 242 (Threadlock and Sealer) EOAZ-19554-AA	WSK-M2G351A5 (Type II)
Nyogel 760G	WSB-M1C239-A
Thermal Grease (Dow Corning® 340)	ESF-M99G123-A

## DESCRIPTION AND OPERATION

### High Voltage/Traction Battery

The traction battery is the primary source of power for the Ranger EV. It is located between the frame rails and underneath the vehicle. The supporting tray contains all of the traction battery components. The tray is made of a strong, non-conductive composite material and has brackets molded into it at various locations. The traction battery, when fully loaded with all necessary components, weighs 884.5 kg (1,950 lb).

---

**DESCRIPTION AND OPERATION (Continued)**

The traction battery contains 39 lead acid battery modules, a battery controller module (BCM), a contactor box, a cooling system, a heating system, and all necessary wiring. The 39 battery modules are wired together in series in order to achieve the necessary 312 volts (nominal) of direct current (DC) required for vehicle operation. The battery modules are stacked in the tray and are separated into an upper and lower level. The BCM is located in the upper front end of the pack. The contactor box is in the upper rear end of the pack. Both the BCM and the contactor box are held in place using strips of Velcro™. The cooling system uses a two-speed blower that is located in the center of the traction battery pack. The fan circulates air through the battery pack during charging in order to control traction battery temperature.

The traction battery heating system is used in cold weather locations. The lower level of battery modules is heated by a large heating element that lays across the bottom of the supporting tray. The upper levels have individual heating elements attached to each module. The heating elements are controlled by the BCM. The BCM will operate the heater elements when the vehicle is connected to a charging station and the temperature is below 15°C (59°F). The BCM will turn the heating system off when the temperature rises above 25°C (77°F).

The traction battery uses a combination of high and low-voltage wiring. The high-voltage wiring is identified by its orange color or orange wrapping. The high-voltage circuit is protected by a 500 volt, 250 amp fuse. The low-voltage harness serves as an interface with the rest of the vehicle. This harness connects the vehicle through a 76-pin connector, located on the LH front of the traction battery.

**Contactor Box**

The contactor box contains relays that switch the high-voltage power on and off. The relays shut off high-voltage when the ignition key is in the OFF position or when the inertia switch has been tripped. The contactor box also contains the pre-charge circuits, battery pack current sensing circuitry, and fuses to protect the charging, battery heater, and high-voltage auxiliary circuits.

**Battery Controller Module (BCM)**

The BCM is a combination low and high-voltage module that controls all traction battery system operations. The BCM monitors the temperature and state of charge for the 39 battery modules, controls traction battery charging, cooling, and heating. The module also calculates the maximum source and sink currents to ensure safe and reliable pack performance.

**High Voltage Power Distribution Box (HVPDB)**

The HVPDB is located on top of the traction battery charger in the underhood compartment. The HVPDB distributes high-voltage to the DC/DC converter, heating system, air conditioning system, power steering system, and the battery charger. The box contains fuses to protect the circuits to which the high-voltage is supplied. The box uses a protective cover that is part of the interlock circuit. When the cover is removed, a limit switch will open the relays in the contactor box to interrupt high-voltage to the vehicle.

**Emergency Power Off (EPO) / Interlock System**

The Electric Ranger is equipped with a power off system that operates in a manner similar to that of a gasoline powered vehicle. When the inertia switch is triggered, the EPO is activated and the contactor box will disable all vehicle power. The power reset light will illuminate to indicate that this situation exists. The inertia switch must be reset before the contactor box will re-activate the vehicle power.

**Leakage Detection**

The battery controller module (BCM) monitors current leakage between traction battery positive and negative terminals and the vehicle chassis. If the detected leakage is below 50k ohms, the BCM will request the interface adapter assembly (IAA) to illuminate the electrical hazard warning light. The BCM monitors the leakage rate once every 20 seconds to ensure safety against electrical hazards and to ensure that it is safe to charge the vehicle.

## DIAGNOSIS AND TESTING

### Auxiliary Contactor Relay Control

#### Diagnostic Trouble Code (DTC) Definition

The following DTC relates to the control of the auxiliary contactor relay:

- DTC C1862 Contactor Circuit Failure
  - The interface adapter assembly (IAA) module controls the auxiliary contactor to provide high-voltage power to the high-voltage auxiliary loads. The IAA module closes the auxiliary contactor when the ignition key is turned to the ON position and monitors its status through a feedback line from the contactor box. The IAA module sets DTC C1862 if it detects the auxiliary contactor open when it should be closed and closed when it should be open.

#### Symptom Chart

##### Symptom Chart

Condition	Possible Sources	Action
<ul style="list-style-type: none"> <li>• DTC C1862 Contactor Circuit Failure</li> </ul>	<ul style="list-style-type: none"> <li>• Circuit(s).</li> <li>• Interface adapter assembly (IAA) module.</li> <li>• High-voltage power distribution box (HVPDB).</li> <li>• Contactor box.</li> <li>• Contactor box high-voltage fuse.</li> </ul>	<ul style="list-style-type: none"> <li>• GO to Pinpoint Test A.</li> </ul>

#### Pinpoint Tests

##### Special Tool(s)

104-Pin Breakout Box (BOB) 418-049 (014-00950) or equivalent
Traction Battery High-Voltage Service Cord 418-F218
Traction Battery Low-Voltage Service Cord 418-F219

(Continued)

#### Electrical Schematic

Refer to Electrical and Vacuum Troubleshooting Manual, Cell 21, Contactor Box Relay Control for schematic and connector information.

#### Inspection and Verification

Refer to [Section 100-07](#).

#### Special Tool(s)

Traction Battery High-Voltage Lockout and Diagnostic Tool 418-F207
High-Voltage Insulated Safety Gloves 100-F036 or equivalent
Face Shield 100-F035 or equivalent



**DIAGNOSIS AND TESTING (Continued)****PINPOINT TEST A: DTC C1862 CONTACTOR CIRCUIT FAILURE**

<b>TEST STEP</b>	<b>ACTION TO TAKE</b>
<p><b>A1 CHECK FOR INTERFACE ADAPTER ASSEMBLY (IAA) MODULE, TRACTION INVERTER MODULE (TIM), AND BATTERY CONTROL MODULE (BCM) DIAGNOSTIC TROUBLE CODES (DTCs)</b></p> <p><b>NOTE:</b> Do not go to test step A2 unless there is a multiple auxiliary load failure and DTC C1862 occurs after the IAA module on-demand self-test is performed.</p> <ul style="list-style-type: none"> <li>Retrieve continuous DTCs from the TIM and perform on-demand self-test for the IAA module and BCM.</li> <li><b>Do IAA module DTCs C1862 Contactor Circuit Failure and U2015 Signal Link Fault (Non SCP), TIM DTC B1676 Battery Pack Voltage Out of Range, and BCM DTC C1837 Battery Heater Circuit Failure all occur?</b></li> </ul>	<p>Yes = REFER to Pinpoint Test A in Main/Precharge Contactor Relay Control in this section.</p> <p>No = GO to A2.</p> <p>If other BCM DTCs occur, REFER to the BCM DTC Index in Section 100-07.</p>
<p><b>A2 CHECK HIGH-VOLTAGE AUXILIARY BUS STATUS</b></p> <ul style="list-style-type: none"> <li>With key ON, monitor IAA module PID AUXHVB.</li> <li><b>Does the AUXHVB PID indicate AVAILA?</b></li> </ul>	<p>Yes = GO to A3.</p> <p>No = If AUXHVB PID indicates UNAVAI, RETRIEVE DTCs from the battery control module (BCM). REFER to Section 100-07. If AUXHVB PID indicates EPO or INERSW, REFER to Emergency Power Off (EPO)/Interlock System in this section.</p>
<p><b>A3 CHECK AUXILIARY CONTACTOR RELAY STATUS</b></p> <ul style="list-style-type: none"> <li>With key ON, monitor IAA module PID AUX__HVC.</li> <li><b>Does the AUX__HVC PID indicate CLOSED?</b></li> </ul>	<p>Yes = System OK. CHECK wiring for intermittent connections.</p> <p>No = If AUX__HVC PID indicates OPEN, GO to A4. If AUX__HVC PID indicates OFAULT, GO to A6.</p>
<p><b>A4 CHECK CHARGER CORD STATUS</b></p> <p><b>NOTE:</b> Verify the power control station (PCS) charger cord is not plugged into the charger inlet before performing this test step.</p> <ul style="list-style-type: none"> <li>With key OFF, monitor BCM PID CHGCORD.</li> <li><b>Does the CHGCORD PID indicate OUT?</b></li> </ul>	<p>Yes = GO to A5.</p> <p>No = RETRIEVE DTCs from the BCM. REFER to Section 100-07.</p>
<p><b>A5 VERIFY AVAILABILITY OF AUXILIARY HIGH-VOLTAGE BUS</b></p> <ul style="list-style-type: none"> <li>With key ON, monitor IAA module PID AUXHVB.</li> <li><b>Does the AUXHVB PID indicate AVAILA?</b></li> </ul>	<p>Yes = REPLACE the IAA module. REFER to Section 412-04.</p> <p>No = RETRIEVE DTCs from the BCM. REFER to Section 100-07.</p>
<p><b>A6 CHECK AUXILIARY CONTACTOR RELAY FAULT STATUS</b></p>	

(Continued)

**DIAGNOSIS AND TESTING (Continued)****PINPOINT TEST A: DTC C1862 CONTACTOR CIRCUIT FAILURE**

<b>TEST STEP</b>	<b>ACTION TO TAKE</b>
<ul style="list-style-type: none"> <li>• Enter IAA module active command mode AUXILIARY SYSTEM CONTROL, monitor IAA module PID AUX__HVC, and set the active command AUX CONT to CLOSE.</li> <li>• After the CLOSE signal is complete, set the active command AUX CONT to OPEN.</li> <li>• <b>Does the AUX__HVC PID indicate CLOSED?</b></li> </ul>	<p>Yes = System OK. CHECK wiring for intermittent connections.</p> <p>No = If AUX__HVC PID indicates CFAULT, GO to A7. If AUX__HVC PID indicates OFAULT, GO to A14.</p>
<p><b>A7 CHECK AUXILIARY CONTACTOR RELAY CONTROL SIGNAL (CLOSE FAULT)</b></p> <ul style="list-style-type: none"> <li>• Connect 104-Pin Breakout Box (BOB) to IAA module and IAA module C1945.</li> <li>• Enter IAA module active command mode AUXILIARY SYSTEM CONTROL, set the active command AUX CONT to OPEN, and measure the voltage between BOB pin 42 and ground (BOB pin 80).</li> <li>• <b>Is the voltage less than 1 volt?</b></li> </ul>	<p>Yes = GO to A10.</p> <p>No = GO to A8.</p>
<p><b>A8 CHECK CIRCUIT 3998 (GY) FOR SHORT TO POWER</b></p> <ul style="list-style-type: none"> <li>• Disconnect BOB from IAA module; leave BOB connected to IAA module C1945.</li> <li>• With key ON, measure the voltage between BOB pin 42 and ground (BOB pin 80).</li> <li>• <b>Is the voltage greater than 0 volts?</b></li> </ul>	<p>Yes = GO to A9.</p> <p>No = REPLACE the IAA module. REFER to Section 412-04.</p>
<p><b>A9 CHECK CIRCUIT 3998 (GY) BETWEEN IAA MODULE AND TRACTION BATTERY SUPPORT TRAY FOR SHORT TO POWER</b></p> <ul style="list-style-type: none"> <li>• With key OFF, disconnect traction battery support tray in-line C1939.</li> <li>• With key ON, measure the voltage between BOB pin 42 and ground (BOB pin 80).</li> <li>• <b>Is the voltage greater than 0 volts?</b></li> </ul>	<p>Yes = REPAIR the GY wire between the IAA module and in-line C1939M.</p> <p>No = REMOVE the traction battery and REPAIR the GY wire between the contactor box and in-line C1939F.</p>
<p><b>A10 CHECK AUXILIARY CONTACTOR RELAY STATUS SIGNAL (CLOSE FAULT)</b></p> <ul style="list-style-type: none"> <li>• Enter IAA module active command mode AUXILIARY SYSTEM CONTROL, set the active command AUX CONT to OPEN, and measure the voltage between BOB pin 26 and ground (BOB pin 80).</li> <li>• <b>Is the voltage greater than 10 volts?</b></li> </ul>	<p>Yes = GO to A11.</p> <p>No = GO to A13.</p>
<p><b>A11 CHECK CIRCUIT 3999 (DB/LG) BETWEEN IAA MODULE AND TRACTION BATTERY SUPPORT TRAY FOR SHORT TO POWER</b></p> <ul style="list-style-type: none"> <li>• Disconnect BOB from IAA module; leave BOB connected to IAA module C1945.</li> <li>• With key OFF, disconnect traction battery support tray in-line C1939.</li> <li>• With key ON, measure the voltage between BOB pin 26 and ground (BOB pin 80).</li> <li>• <b>Is the voltage greater than 0 volts?</b></li> </ul>	<p>Yes = REPAIR the DB/LG wire between the IAA module and in-line C1939M.</p> <p>No = GO to A12.</p>
<p><b>A12 CHECK CIRCUIT 3999 (DB/LG) BETWEEN CONTACTOR BOX AND TRACTION BATTERY SUPPORT TRAY FOR SHORT TO POWER</b></p> <ul style="list-style-type: none"> <li>• Disconnect BOB from IAA module C1945.</li> </ul>	<p>Yes = REPAIR the DB/LG wire between the contactor box and in-line C1939F.</p>

(Continued)

**DIAGNOSIS AND TESTING (Continued)****PINPOINT TEST A: DTC C1862 CONTACTOR CIRCUIT FAILURE**

TEST STEP	ACTION TO TAKE
<ul style="list-style-type: none"> <li>• Remove the traction battery and connect Traction Battery High-Voltage Lockout and Diagnostic Tool to traction battery high-voltage two-pin C3994M.</li> </ul> <p><b>⚠ WARNING: The traction battery contains high-voltage components and wiring. High-voltage insulated safety gloves and face shield must be worn when performing the following steps. Failure to follow this warning may result in severe personal injury or death.</b></p> <ul style="list-style-type: none"> <li>• Connect Traction Battery High-Voltage Service Cord to traction battery support tray in-line C1935F and in-line C1935M.</li> <li>• Connect BOB to traction battery support tray in-line C1939F using Traction Battery Low-Voltage Service Cord; do not connect Traction Battery Low-Voltage Service Cord to in-line C1939M.</li> <li>• With key OFF, disconnect contactor box C1982.</li> <li>• With key ON, measure the voltage between BOB pin 17 and ground (BOB pin 65).</li> <li>• <b>Is the voltage greater than 0 volts?</b></li> </ul>	No = REPLACE the contactor box.
<b>A13 CHECK AUXILIARY CONTACTOR RELAY FEEDBACK STATUS</b> <ul style="list-style-type: none"> <li>• With key ON, monitor IAA module AUXCN_I.</li> <li>• <b>Does the AUXCN_I PID indicate ENABLED?</b></li> </ul>	Yes = REPLACE the IAA module. REFER to Section 412-04. No = System OK. CHECK wiring for intermittent connections.
<b>A14 CHECK AUXILIARY CONTACTOR RELAY STATUS SIGNAL (OPEN FAULT)</b> <ul style="list-style-type: none"> <li>• Connect 104-Pin Breakout Box (BOB) to IAA module and IAA module C1945.</li> <li>• Enter IAA module active command mode AUXILIARY SYSTEM CONTROL, set the active command AUX CONT to CLOSE, and measure the voltage between BOB pin 26 and ground (BOB pin 80).</li> <li>• <b>Is the voltage greater than 10 volts?</b></li> </ul>	Yes = System OK. CHECK wiring for intermittent connections. No = GO to A15.
<b>A15 CHECK AUXILIARY CONTACTOR RELAY CONTROL SIGNAL (OPEN FAULT)</b> <ul style="list-style-type: none"> <li>• Enter IAA module active command mode AUXILIARY SYSTEM CONTROL, set the active command AUX CONT to CLOSE, and measure the voltage between BOB pin 42 and ground (BOB pin 80).</li> <li>• <b>Is the voltage greater than 10 volts?</b></li> </ul>	Yes = GO to A18. No = GO to A16.
<b>A16 CHECK CIRCUIT 3998 (GY) FOR SHORT TO GROUND</b> <ul style="list-style-type: none"> <li>• Disconnect BOB from IAA module; leave BOB connected to IAA module C1945.</li> <li>• With key OFF, measure the resistance between BOB pin 42 and ground (BOB pin 80).</li> <li>• <b>Is the resistance greater than 10,000 ohms?</b></li> </ul>	Yes = REPLACE the IAA module. REFER to Section 412-04. No = GO to A17.
<b>A17 CHECK CIRCUIT 3998 (GY) BETWEEN IAA MODULE AND TRACTION BATTERY SUPPORT TRAY FOR SHORT TO GROUND</b> <ul style="list-style-type: none"> <li>• With key OFF, disconnect traction battery support tray in-line C1939.</li> <li>• With key OFF, measure the resistance between BOB pin 42 and ground (BOB pin 80).</li> <li>• <b>Is the resistance greater than 10,000 ohms?</b></li> </ul>	Yes = REMOVE the traction battery and REPAIR the GY wire between the contactor box and in-line C1939F. No = REPAIR the GY wire between the IAA module and in-line C1939M.

(Continued)

**DIAGNOSIS AND TESTING (Continued)****PINPOINT TEST A: DTC C1862 CONTACTOR CIRCUIT FAILURE**

TEST STEP	ACTION TO TAKE
<p><b>A18 CHECK CIRCUITS 3998 (GY) AND 3999 (DB/LG) BETWEEN IAA MODULE AND TRACTION BATTERY SUPPORT TRAY FOR OPEN(S)</b></p> <ul style="list-style-type: none"> <li>• With key OFF, disconnect traction battery support tray in-line C1939 and measure the resistance of the GY wire between pin 16 on in-line C1939M and BOB pin 42.</li> <li>• With key OFF, measure the resistance of the DB/LG wire between pin 17 on in-line C1939M and BOB pin 26.</li> <li>• <b>Are the resistances less than 5 ohms?</b></li> </ul>	<p>Yes = GO to <b>A19</b>.</p> <p>No = REPAIR the wire(s) in question.</p>
<p><b>A19 CHECK CIRCUIT 3999 (DB/LG) BETWEEN IAA MODULE AND TRACTION BATTERY SUPPORT TRAY FOR SHORT TO GROUND</b></p> <ul style="list-style-type: none"> <li>• Disconnect BOB from IAA module; leave BOB connected to IAA module C1945.</li> <li>• With key OFF, measure the resistance between BOB pin 26 and ground (BOB pin 80).</li> <li>• <b>Is the resistance greater than 10,000 ohms?</b></li> </ul>	<p>Yes = GO to <b>A20</b>.</p> <p>No = REPAIR the DB/LG wire.</p>
<p><b>A20 CHECK CIRCUITS 3998 (GY) AND 3999 (DB/LG) BETWEEN CONTACTOR BOX AND TRACTION BATTERY SUPPORT TRAY FOR OPEN(S)</b></p> <ul style="list-style-type: none"> <li>• Disconnect BOB from IAA module C1945; do not reconnect IAA module C1945.</li> <li>• Remove the traction battery.</li> </ul> <p> <b>WARNING: The traction battery contains high-voltage components and wiring. High-voltage insulated safety gloves and face shield must be worn when performing the following steps. Failure to follow this warning may result in severe personal injury or death.</b></p> <ul style="list-style-type: none"> <li>• Connect BOB to traction battery support tray in-line C1939F using Traction Battery Low-Voltage Service Cord; do not connect Traction Battery Low-Voltage Service Cord to in-line C1939M.</li> <li>• With key OFF, disconnect contactor box C1982 and measure the resistance of the GY wire between pin 19 on contactor box C1982 and BOB pin 16.</li> <li>• With key OFF, measure the resistance of the DB/LG wire between pin 1 on contactor box C1982 and BOB pin 17.</li> <li>• <b>Are the resistances less than 5 ohms?</b></li> </ul>	<p>Yes = GO to <b>A21</b>.</p> <p>No = REPAIR the wire(s) in question.</p>
<p><b>A21 CHECK CIRCUIT 3999 (DB/LG) BETWEEN CONTACTOR BOX AND TRACTION BATTERY SUPPORT TRAY FOR SHORT TO GROUND</b></p> <ul style="list-style-type: none"> <li>• With key OFF, measure the resistance between BOB pin 17 and ground (BOB pin 65).</li> <li>• <b>Is the resistance greater than 10,000 ohms?</b></li> </ul>	<p>Yes = GO to <b>A22</b>.</p> <p>No = REPAIR the DB/LG wire.</p>
<p><b>A22 CHECK HIGH-VOLTAGE AUXILIARY POSITIVE BUS FOR OPEN</b></p> <ul style="list-style-type: none"> <li>• Disconnect power steering assembly high-voltage C1895.</li> <li>• Measure the resistance between circuit 3140 (BK wire) on power steering assembly C1895 and circuit 3132 (Y wire) on high-voltage auxiliary load in-line C1935M.</li> <li>• <b>Is the resistance less than 5 ohms?</b></li> </ul>	<p>Yes = GO to <b>A23</b>.</p> <p>No = REPLACE the HVPDB.</p>

(Continued)

**DIAGNOSIS AND TESTING (Continued)****PINPOINT TEST A: DTC C1862 CONTACTOR CIRCUIT FAILURE**

TEST STEP	ACTION TO TAKE
<b>A23 CHECK CONTACTOR BOX HIGH-VOLTAGE FUSE</b> <ul style="list-style-type: none"> <li>• Remove the 40A AUX fuse from the contactor box. Refer to Contactor Box Fuses Removal and Installation procedure in this section.</li> <li>• Measure the resistance of the 40A AUX fuse.</li> <li>• <b>Is the resistance greater than 1,000 ohms?</b></li> </ul>	Yes = REPLACE the 40A AUX fuse. No = REPLACE the contactor box.

**Main/Precharge Contactor Relay Control****Diagnostic Trouble Code (DTC) Definitions**

The following DTCs relate to the contactor box relays that are controlled by the traction inverter module (TIM):

- DTC B1676 Battery Pack Voltage Out of Range
  - The TIM monitors the traction battery voltage at its high-voltage input terminals. The TIM receives high-voltage power when the contactor box main contactor closes. The TIM closes the main contactor after the precharge sequence is complete and the ignition key is turned to the START position with the gear selector in the P (Park) or N (Neutral) position. The TIM sets DTC B1676 when it detects the traction battery voltage is less than 50 volts or greater than 385 volts after the contactor box main contactor has been commanded closed. If this occurs the TIM will shut down, preventing the motor from being enabled and the malfunction indicator lamp (MIL) will illuminate.

- DTC C1862 Contactor Circuit Failure

- The TIM controls two contactor box relays, the precharge and main contactor relays. There are capacitors at the high-voltage input to the TIM that are charged at a slow rate to a high-voltage level when the precharge contactor relay is closed. This prevents arcing and damage to the main contactor relay if the main contactor relay closes without precharge. The TIM closes the precharge contactor relay when the ignition key is turned to the ON position. The TIM sets DTC C1862 if the precharge sequence fails. If this occurs, the TIM will shut down preventing the motor from being enabled and the MIL will illuminate. The TIM also performs a test to determine if the main and/or precharge contactor relays are welded. The TIM sets DTC C1862 if welded contactor relay(s) have been detected. If this occurs, the TIM will allow the motor to be enabled and the MIL will illuminate. The TIM will also send a SCP message (main contactor relay welded/stuck closed) to the Battery Control Module (BCM) so the BCM will not allow charging.

**Electrical Schematic**

Refer to Electrical and Vacuum Troubleshooting Manual, Cell 21, Contactor Box Relay Control for schematic and connector information.

**Inspection and Verification**

Refer to [Section 100-07](#).

**DIAGNOSIS AND TESTING (Continued)**

**Symptom Chart**

**Symptom Chart**

Condition	Possible Sources	Action
<ul style="list-style-type: none"> <li>DTC B1676 Battery Pack Voltage Out of Range</li> </ul>	<ul style="list-style-type: none"> <li>Contactor box.</li> <li>Circuit(s).</li> <li>Traction inverter module (TIM).</li> <li>Low voltage TIM fuses:                             <ul style="list-style-type: none"> <li>— 9 (10A)</li> <li>— 11 (7.5A)</li> <li>— 24 (7.5A)</li> </ul> </li> <li>Traction battery high-voltage fuse.</li> </ul>	<ul style="list-style-type: none"> <li>GO to Pinpoint Test A.</li> </ul>
<ul style="list-style-type: none"> <li>DTC C1862 Contactor Circuit Failure</li> </ul>	<ul style="list-style-type: none"> <li>Circuit(s).</li> <li>Traction inverter module (TIM).</li> <li>Contactor box.</li> </ul>	<ul style="list-style-type: none"> <li>GO to Pinpoint Test B.</li> </ul>

**Pinpoint Tests**

**Special Tool(s)**

**Special Tool(s)**

104-Pin Breakout Box (BOB) 418-049 (014-00950) or equivalent
BCM/TIM Breakout Box (BOB) Adapter Cable 418-F212
BCM/TIM Breakout Box (BOB) Overlay 418-F220

(Continued)

Traction Battery Low-Voltage Service Cord 418-F219
Traction Battery High-Voltage Lockout and Diagnostic Tool 418-F207
High-Voltage Insulated Safety Gloves 100-F036 or equivalent
Face Shield 100-F035 or equivalent

**PINPOINT TEST A: DTC B1676 BATTERY PACK VOLTAGE OUT OF RANGE**

TEST STEP	ACTION TO TAKE
<p><b>A1 CHECK FOR INTERFACE ADAPTER ASSEMBLY (IAA) MODULE AND BATTERY CONTROL MODULE (BCM) DIAGNOSTIC TROUBLE CODES (DTCs)</b></p> <p><b>NOTE:</b> Make sure low voltage TIM fuse(s) #9 (10A), #11 (7.5A), and #24 (7.5A) are good before performing test A1. If fuse(s) are OK, proceed with A1, if not, install new fuse(s) and perform test A1.</p> <p><b>NOTE:</b> Using High-Voltage Insulated Safety Gloves and Face Shield, disconnect and check the traction battery high-voltage two-pin C3994 for damage before performing the following test steps. Repair as necessary. If OK, reconnect and verify the connection is secure.</p> <ul style="list-style-type: none"> <li>Perform the on-demand self-test for the IAA module and BCM.</li> <li>Do IAA module DTCs C1862 Contactor Circuit Failure and U2015 Signal Link Fault (Non SCP), and BCM DTC C1837 Battery Heater Circuit Failure occur?</li> </ul>	<p>Yes = GO to A2.</p> <p>No = GO to A4.</p> <p>If other BCM DTCs occur, REFER to the BCM DTC Index in Section 100-07.</p>
<p><b>A2 CHECK GROUND TO CONTACTOR BOX</b></p>	

(Continued)

**DIAGNOSIS AND TESTING (Continued)****PINPOINT TEST A: DTC B1676 BATTERY PACK VOLTAGE OUT OF RANGE**

TEST STEP	ACTION TO TAKE
<ul style="list-style-type: none"> <li>With key OFF, disconnect traction battery support tray in-line C1939 and connect 104-Pin Breakout Box (BOB) to traction battery support tray in-line C1939M using Traction Battery Low-Voltage Service Cord; do not connect Traction Battery Low-Voltage Service Cord to in-line C1939F.</li> <li>With key OFF, measure the resistance between BOB pin 65 and ground.</li> <li><b>Is the resistance less than 5 ohms?</b></li> </ul>	Yes = GO to <b>A3</b> .  No = REPAIR the BK wire.
<b>A3 CHECK CIRCUIT 57 (BK) FOR OPEN</b> <ul style="list-style-type: none"> <li>Disconnect the BOB from in-line C1939M and remove the traction battery.</li> </ul> <p><b>⚠ WARNING: The traction battery contains high-voltage components and wiring. High-voltage insulated safety gloves and face shield must be worn when performing the following steps. Failure to follow this warning may result in severe personal injury or death.</b></p> <ul style="list-style-type: none"> <li>Connect BOB to traction battery support tray in-line C1939F using Traction Battery Low-Voltage Service Cord.</li> <li>With key OFF, disconnect contactor box C1982 and measure the resistance between pin 8 (BK wire) on contactor box C1982 and BOB pin 65.</li> <li><b>Is the resistance less than 5 ohms?</b></li> </ul>	Yes = REPLACE the contactor box.  No = REPAIR the BK wire.
<b>A4 CHECK STATUS OF HIGH-VOLTAGE POWER TO TIM</b> <ul style="list-style-type: none"> <li>With key ON, monitor TIM PID BAT__PV.</li> </ul> <ul style="list-style-type: none"> <li>Turn the ignition key to the START position.</li> <li><b>Does the BAT__PV PID indicate between 50 and 385 volts?</b></li> </ul>	Yes = System OK. CHECK wiring for intermittent connections.  No = If less than 50 volts, GO to <b>A5</b> .  If greater than 385 volts, GO to <b>A12</b> .
<b>A5 CHECK MAIN CONTACTOR RELAY</b> <p><b>NOTE:</b> The active command PRECHG IN must be sent before sending the active command POS MAIN. If not, New Generation STAR (NGS) Tester will indicate UNABLE TO PERFORM TEST/FUNCTION.</p> <ul style="list-style-type: none"> <li>Enter the TIM active command mode CONTACTOR OUTPUT CONTROL, monitor the TIM PID BAT__PV, and set the active commands PRECHG IN and POS MAIN to CLOSE.</li> <li>Set the active command PRECHG IN to OPEN.</li> <li><b>Does the BAT__PV PID indicate less than 50 volts?</b></li> </ul>	Yes = GO to <b>A6</b> .  No = GO to <b>A12</b> .
<b>A6 CHECK TIM MAIN CONTACTOR CONTROL SIGNAL TO CONTACTOR BOX AT TRACTION BATTERY SUPPORT TRAY</b> <ul style="list-style-type: none"> <li>With key OFF, disconnect traction battery support tray in-line C1939 and connect 104-Pin Breakout Box (BOB) to traction battery support tray in-line C1939F and in-line C1939M using Traction Battery Low-Voltage Service Cord.</li> <li>Turn the ignition key to the START position and measure the voltage between BOB pin 23 and ground (BOB pin 65).</li> <li><b>Is the voltage greater than 10 volts?</b></li> </ul>	Yes = GO to <b>A9</b> .  No = GO to <b>A7</b> .
<b>A7 CHECK CIRCUIT 3986 (DG) BETWEEN TIM AND TRACTION BATTERY SUPPORT TRAY FOR OPEN</b> <ul style="list-style-type: none"> <li>With key OFF, disconnect TIM C4998 and measure the resistance of the DG wire between pin 8 on TIM C4998 and BOB pin 23.</li> <li><b>Is the resistance less than 5 ohms?</b></li> </ul>	Yes = GO to <b>A8</b> .  No = REPAIR the DG wire.

(Continued)

**DIAGNOSIS AND TESTING (Continued)****PINPOINT TEST A: DTC B1676 BATTERY PACK VOLTAGE OUT OF RANGE**

<b>TEST STEP</b>	<b>ACTION TO TAKE</b>
<b>A8 CHECK CIRCUIT 3986 (DG) BETWEEN TIM AND TRACTION BATTERY SUPPORT TRAY FOR SHORT TO GROUND</b> <ul style="list-style-type: none"> <li>With key OFF, measure the resistance between BOB pin 23 and ground (BOB pin 65).</li> <li><b>Is the resistance greater than 10,000 ohms?</b></li> </ul>	Yes = REPLACE the TIM. REFER to Section 303-14. No = REPAIR the DG wire.
<b>A9 CHECK CIRCUIT 3986 (DG) BETWEEN CONTACTOR BOX AND TRACTION BATTERY SUPPORT TRAY FOR OPEN</b> <ul style="list-style-type: none"> <li>With key OFF, disconnect the BOB from traction battery support tray in-line C1939F and in-line C1939M and remove the traction battery.</li> </ul> <p><b>⚠ WARNING: The traction battery contains high-voltage components and wiring. High-voltage insulated safety gloves and face shield must be worn when performing the following steps. Failure to follow this warning may result in severe personal injury or death.</b></p> <ul style="list-style-type: none"> <li>Reconnect BOB to traction battery support tray in-line C1939F using Traction Battery Low-Voltage Service Cord; do not connect Traction Battery Low-Voltage Service Cord to in-line C1939M.</li> <li>With key OFF, disconnect contactor box C1982 and measure the resistance of the DG wire between pin 11 on contactor box C1982 and BOB pin 23.</li> <li><b>Is the resistance less than 5 ohms?</b></li> </ul>	Yes = GO to <b>A10</b> . No = REPAIR the DG wire.
<b>A10 CHECK CIRCUIT 3986 (DG) BETWEEN CONTACTOR BOX AND TRACTION BATTERY SUPPORT TRAY FOR SHORT TO GROUND</b> <ul style="list-style-type: none"> <li>With key OFF, measure the resistance between BOB pin 23 and ground (BOB pin 65).</li> <li><b>Is the resistance greater than 10,000 ohms?</b></li> </ul>	Yes = GO to <b>A11</b> . No = REPAIR the DG wire.
<b>A11 CHECK TRACTION BATTERY HIGH-VOLTAGE FUSE</b> <ul style="list-style-type: none"> <li>Measure the resistance between the terminals of the 250A traction battery high-voltage fuse.</li> <li><b>Is the resistance less than 5 ohms?</b></li> </ul>	Yes = REPLACE the contactor box. No = REPLACE the fuse.
<b>A12 CHECK TRACTION BATTERY VOLTAGE</b> <ul style="list-style-type: none"> <li>With key ON, monitor BCM PID BAT__PV and TIM PID BAT__PV.</li> <li>Turn the ignition key to the START position.</li> <li><b>Is there more than a 30-volt difference between the BAT__PV PIDs?</b></li> </ul>	Yes = REPLACE the TIM. REFER to Section 303-14. No = System OK. CHECK wiring for intermittent connections.

**PINPOINT TEST B: DTC C1862 CONTACTOR CIRCUIT FAILURE**

<b>TEST STEP</b>	<b>ACTION TO TAKE</b>
<b>B1 CHECK FOR INTERFACE ADAPTER ASSEMBLY (IAA) MODULE AND BATTERY CONTROL MODULE (BCM) DIAGNOSTIC TROUBLE CODES (DTCs)</b> <p><b>NOTE:</b> Using High-Voltage Insulated Safety Gloves and Face Shield, disconnect and check the traction battery high-voltage two-pin C3994 for damage before performing the following test steps. Repair as necessary. If OK, reconnect and verify the connection is secure.</p> <ul style="list-style-type: none"> <li>Perform the on-demand self-test for the IAA module and BCM.</li> <li><b>Do IAA module DTCs C1862 Contactor Circuit Failure and U2015 Signal Link Fault (Non SCP), and BCM DTC C1837 Battery Heater Circuit Failure occur?</b></li> </ul>	Yes = GO to Pinpoint Test A. No = GO to <b>B2</b> .

(Continued)



**DIAGNOSIS AND TESTING (Continued)****PINPOINT TEST B: DTC C1862 CONTACTOR CIRCUIT FAILURE**

TEST STEP	ACTION TO TAKE
	If other BCM DTCs occur, REFER to the BCM DTC Index in Section 100-07.
<b>B2 CHECK FOR TRACTION INVERTER MODULE (TIM) PRECHARGE FAULT</b> <ul style="list-style-type: none"> <li>• With key ON, monitor TIM PID PRECH__F.</li> <li>• Does the PRECH__F PID indicate YES?</li> </ul>	Yes = GO to <b>B3</b> . No = GO to <b>B11</b> .
<b>B3 CHECK STATUS OF TIM PRECHARGE BUS VOLTAGE</b> <ul style="list-style-type: none"> <li>• With key ON, monitor TIM PID BAT__PV.</li> <li>• Does the BAT__PV PID indicate less than 50 volts?</li> </ul>	Yes = GO to <b>B4</b> . No = GO to <b>B10</b> .
<b>B4 CHECK PRECHARGE CONTACTOR RELAY</b> <ul style="list-style-type: none"> <li>• Enter the TIM active command mode CONTACTOR OUTPUT CONTROL, monitor the TIM PID BAT__PV, and set the active command PRECHG IN to CLOSE.</li> <li>• Does the BAT__PV PID indicate less than 50 volts?</li> </ul>	Yes = GO to <b>B5</b> . No = GO to <b>B10</b> .
<b>B5 CHECK TIM PRECHARGE CONTACTOR CONTROL SIGNAL TO TRACTION BATTERY SUPPORT TRAY</b> <ul style="list-style-type: none"> <li>• With key OFF, disconnect traction battery support tray in-line C1939 and connect 104-Pin Breakout Box (BOB) to traction battery support tray in-line C1939F and in-line C1939M using Traction Battery Low-Voltage Service Cord.</li> <li>• With key ON, measure the voltage between BOB pin 22 and ground (BOB pin 65).</li> <li>• Is the voltage greater than 10 volts?</li> </ul>	Yes = GO to <b>B8</b> . No = GO to <b>B6</b> .
<b>B6 CHECK CIRCUIT 3991 (T) BETWEEN TIM AND TRACTION BATTERY SUPPORT TRAY FOR OPEN</b> <ul style="list-style-type: none"> <li>• With key OFF, disconnect TIM C4998 and measure the resistance of the T wire between pin 18 on TIM C4998 and BOB pin 22.</li> <li>• Is the resistance less than 5 ohms?</li> </ul>	Yes = GO to <b>B7</b> . No = REPAIR the T wire.
<b>B7 CHECK CIRCUIT 3991 (T) BETWEEN TIM AND TRACTION BATTERY SUPPORT TRAY FOR SHORT TO GROUND</b> <ul style="list-style-type: none"> <li>• With key OFF, measure the resistance between BOB pin 22 and ground (BOB pin 65).</li> <li>• Is the resistance greater than 10,000 ohms?</li> </ul>	Yes = REPLACE the TIM. REFER to Section 303-14. No = REPAIR the T wire.
<b>B8 CHECK CIRCUIT 3991 (T) BETWEEN CONTACTOR BOX AND TRACTION BATTERY SUPPORT TRAY FOR OPEN</b> <ul style="list-style-type: none"> <li>• With key OFF, disconnect the BOB from traction battery support tray in-line C1939F and in-line C1939M and remove the traction battery.</li> </ul> <p> <b>WARNING:</b> The traction battery contains high-voltage components and wiring. High-voltage insulated safety gloves and face shield must be worn when performing the following steps. Failure to follow this warning may result in severe personal injury or death.</p> <ul style="list-style-type: none"> <li>• Reconnect BOB to traction battery support tray in-line C1939F using Traction Battery Low-Voltage Service Cord; do not connect Traction Battery Low-Voltage Service Cord to in-line C1939M.</li> <li>• With key OFF, disconnect contactor box C1982 and measure the resistance of the T wire between pin 18 on contactor box C1982 and BOB pin 22.</li> <li>• Is the resistance less than 5 ohms?</li> </ul>	Yes = GO to <b>B9</b> . No = REPAIR the T wire.
<b>B9 CHECK CIRCUIT 3991 (T) BETWEEN CONTACTOR BOX AND TRACTION BATTERY SUPPORT TRAY FOR SHORT TO GROUND</b>	

(Continued)

**DIAGNOSIS AND TESTING (Continued)****PINPOINT TEST B: DTC C1862 CONTACTOR CIRCUIT FAILURE**

<b>TEST STEP</b>	<b>ACTION TO TAKE</b>
<ul style="list-style-type: none"> <li>• With key OFF, measure the resistance between BOB pin 22 and ground (BOB pin 65).</li> <li>• <b>Is the resistance greater than 10,000 ohms?</b></li> </ul>	Yes = REPLACE the contactor box. No = REPAIR the T wire.
<b>B10 CHECK TRACTION BATTERY VOLTAGE</b> <ul style="list-style-type: none"> <li>• With key ON, monitor BCM PID BAT__PV and TIM PID BAT__PV.</li> <li>• <b>Is there more than a 30-volt difference between the BAT__PV PIDs?</b></li> </ul>	Yes = REPLACE the TIM. REFER to Section 303-14. No = System OK. CHECK wiring for intermittent connections.
<b>B11 CHECK FOR WELDED MAIN CONTACTOR RELAY</b> <ul style="list-style-type: none"> <li>• Enter TIM active command mode CONTACTOR OUTPUT CONTROL and monitor TIM PID BAT__PV.</li> <li>• <b>Does the voltage for the BAT__PV PID decrease?</b></li> </ul>	Yes = System OK. CHECK wiring for intermittent connections. No = GO to <b>B12</b> .
<b>B12 CHECK MAIN AND PRECHARGE CONTACTOR RELAY OUTPUTS</b> <ul style="list-style-type: none"> <li>• Connect 104-Pin Breakout Box (BOB) to TIM and TIM C4998, C4999 using the BCM/TIM BOB Adapter Cable and Overlay.</li> <li>• Enter traction inverter module (TIM) active command mode CONTACTOR OUTPUT CONTROL.</li> <li>• With key ON, measure the voltage between BOB pins A8, A18 and ground (BOB pin A29).</li> <li>• <b>Is either voltage greater than 10 volts?</b></li> </ul>	Yes = GO to <b>B13</b> . No = REPLACE the contactor box.
<b>B13 CHECK CIRCUITS 3991 (T) AND 3986 (DG) FOR SHORT(S) TO POWER</b> <ul style="list-style-type: none"> <li>• With key OFF, disconnect the TIM from the BOB; leave BOB connected to TIM C4998, C4999.</li> <li>• With key ON, measure the voltage between BOB pins A8, A18 and ground (BOB pin A29).</li> <li>• <b>Is either voltage greater than 1 volt?</b></li> </ul>	Yes = REPAIR the wire(s) in question. No = REPLACE the TIM. REFER to Section 303-14.

## DIAGNOSIS AND TESTING (Continued)

### Negative Contactor Relay Control

#### Diagnostic Trouble Code (DTC) Definition

The following DTC relates to the negative contactor relay in the contactor box:

- DTC C1862 Contactor Circuit Failure
  - The battery control module (BCM) performs a battery heater test during on-demand self-test with the negative contactor relay closed and then open. Under normal conditions, the heater test will pass with the negative contactor relay closed and fail when it is opened. The BCM sets DTC C1862 if the heater test passes with the negative contactor relay closed and then passes with the negative contactor relay open. This indicates the negative contactor relay is stuck closed. Additionally, the BCM sets DTC C1862 if the traction inverter module (TIM) detects a welded main contactor relay and sends the BCM a disable charging message. The BCM also sets DTC C1862 before entering current mode, voltage mode, and during voltage mode each time before charging if there is current flow through the contactor box auxiliary current sensor while the BCM asserts the negative bus open signal and enables the charger with 72% duty cycle in current mode.

#### Symptom Chart

##### Symptom Chart

Condition	Possible Sources	Action
<ul style="list-style-type: none"> <li>• DTC C1862 Contactor Circuit Failure</li> </ul>	<ul style="list-style-type: none"> <li>• Circuit.</li> <li>• Contactor box.</li> <li>• Battery control module (BCM).</li> </ul>	<ul style="list-style-type: none"> <li>• GO to Pinpoint Test A.</li> </ul>

#### Pinpoint Tests

##### Special Tool(s)

104-Pin Breakout Box (BOB) 418-049 (014-00950) or equivalent
BCM/TIM Breakout Box (BOB) Adapter Cable 418-F212
BCM/TIM Breakout Box (BOB) Overlay 418-F220

(Continued)

#### Electrical Schematic

Refer to Electrical and Vacuum Troubleshooting Manual, Cell 21, Contactor Box Relay Control for schematic and connector information.

#### Inspection and Verification

Refer to [Section 100-07](#).

#### Special Tool(s)

Traction Battery High-Voltage Service Cord 418-F218
Traction Battery Low-Voltage Service Cord 418-F219
Traction Battery High-Voltage Lockout and Diagnostic Tool 418-F207
High-Voltage Insulated Safety Gloves 100-F036 or equivalent
Face Shield 100-F035 or equivalent

**DIAGNOSIS AND TESTING (Continued)****PINPOINT TEST A: DTC C1862 CONTACTOR CIRCUIT FAILURE**

TEST STEP	ACTION TO TAKE
<p><b>A1 CHECK STATUS OF BATTERY CONTROL MODULE (BCM) OPERATING STATE</b></p> <ul style="list-style-type: none"> <li>Connect the vehicle to the power control station (PCS) and press the START button (if necessary) to begin charging.</li> <li>With key OFF, monitor BCM PID BCM__OP.</li> <li><b>Does the BCM__OP PID indicate 106 (negative contactor relay welded/stuck closed) or 107 (no charge-TIM SCP message: main contactor relay welded/stuck closed)?</b></li> </ul>	<p>Yes = If 106, GO to <b>A2</b>.</p> <p>If 107, GO to Pinpoint Test B in Main/Precharge Contactor Relay Control.</p> <p>No = System OK.</p>
<p><b>A2 CHECK FOR WELDED MAIN CONTACTOR RELAY</b></p> <ul style="list-style-type: none"> <li>Press the STOP button on the PCS and disconnect the PCS from the charger inlet.</li> <li>Enter traction inverter module (TIM) active command mode CONTACTOR OUTPUT CONTROL and monitor TIM PID BAT__PV.</li> <li><b>Does the voltage for the BAT__PV PID decrease?</b></li> </ul>	<p>Yes = GO to <b>A3</b>.</p> <p>No = REPLACE the contactor box.</p>
<p><b>A3 CHECK (MANUALLY) FOR WELDED CONTACTOR RELAY(S)</b></p> <p><b>NOTE:</b> Do not connect the Traction Battery High-Voltage Lockout and Diagnostic Tool or any of the traction battery service cords until indicated to do so.</p> <ul style="list-style-type: none"> <li>Remove the traction battery.</li> </ul> <p> <b>WARNING: The traction battery contains high-voltage components and wiring. High-voltage insulated safety gloves and face shield must be worn when performing the following steps. Failure to follow this warning may result in severe personal injury or death.</b></p> <ul style="list-style-type: none"> <li><b>NOTE:</b> The high-voltage input to the contactor box is on the passenger side of the contactor box. The high-voltage negative input to the contactor box is the post towards the front of the vehicle and the high-voltage positive input is the post towards the rear of the vehicle. The high-voltage negative output pin for the traction battery two-pin connector (C3994) is the pin towards the front of the vehicle and the high-voltage positive output pin is the pin towards the rear of the vehicle. Measure the voltage between the high-voltage positive post on the contactor box and the high-voltage negative pin on the traction battery two-pin connector.</li> <li>Measure the voltage between the high-voltage negative post on the contactor box and the high-voltage positive pin on the traction battery two-pin connector.</li> <li><b>Are any of the voltages greater than 200 volts?</b></li> </ul>	<p>Yes = REPLACE the contactor box.</p> <p>No = GO to <b>A4</b>.</p>
<p><b>A4 CHECK NEGATIVE CONTACTOR RELAY CONTROL (OPEN SIGNAL)</b></p> <ul style="list-style-type: none"> <li>Connect Traction Battery High-Voltage Lockout and Diagnostic Tool to the traction battery high-voltage two-pin C3994M.</li> </ul>	<p>Yes = GO to <b>A6</b>.</p>

(Continued)

**DIAGNOSIS AND TESTING (Continued)**

**PINPOINT TEST A: DTC C1862 CONTACTOR CIRCUIT FAILURE**

TEST STEP	ACTION TO TAKE
<ul style="list-style-type: none"> <li>• Connect Traction Battery High-Voltage Service Cord to traction battery support tray in-line C1935F and in-line C1935M.</li> <li>• Connect Traction Battery Low-Voltage Service Cord to traction battery support tray in-line C1939F and in-line C1939M.</li> <li>• Connect 104-Pin Breakout Box (BOB) to battery control module (BCM) and BCM C1986, C1987 using BCM/TIM BOB Adapter Cable and Overlay.</li> <li>• Enter BCM active command mode CONTACTOR OUTPUT CONTROL, set the active command NEG MAIN to OPEN, and measure the voltage between BOB pin B7 and ground (BOB pin A33).</li> <li>• <b>Is the voltage greater than 10 volts?</b></li> </ul>	No = GO to A5.
<p><b>A5 CHECK CIRCUIT 3136 (W) FOR SHORT TO GROUND</b></p> <ul style="list-style-type: none"> <li>• With key OFF, disconnect BOB from BCM; leave BOB connected to BCM C1986 and C1987.</li> <li>• With key OFF, disconnect contactor box C1982 and measure the resistance between BOB pin B7 and ground (BOB pin A33).</li> <li>• <b>Is the resistance greater than 10,000 ohms?</b></li> </ul>	Yes = REPLACE the BCM.  No = REPAIR the W wire.
<p><b>A6 CHECK CIRCUIT 3136 (W) FOR OPEN</b></p> <ul style="list-style-type: none"> <li>• With key OFF, disconnect contactor box C1982 and measure the resistance of the W wire between pin 3 on contactor box C1982 and BOB pin B7.</li> <li>• <b>Is the resistance less than 5 ohms?</b></li> </ul>	Yes = REPLACE the contactor box.  No = REPAIR the W wire.

**Emergency Power Off (EPO)/Interlock System**

**Diagnostic Trouble Code (DTC) Definition**

The following DTC relates to the Emergency Power Off (EPO)/Interlock System:

- DTC B2517 Emergency Power Off System Faulted
  - An emergency power off (EPO) occurs when the contactor box outputs an EPO signal through the EPO circuit to the battery control module (BCM), interface adapter assembly (IAA) module and positive temperature coefficient (PTC) switching module. If an EPO condition occurs, the contactor box disables the high-voltage system and the IAA module sets DTC B2517. An open high-voltage connector interlock, an EPO request from the BCM and an activated inertia switch will cause an EPO condition. The IAA module will not set DTC B2517 if the inertia switch is activated. If the inertia switch is activated, the power reset indicator will illuminate.

**Electrical Schematic**

Refer to Electrical and Vacuum Troubleshooting Manual, Cell 20, Emergency Power Off (EPO)/Interlock System for schematic and connector information.

**Inspection and Verification**

Refer to [Section 100-07](#).

**DIAGNOSIS AND TESTING (Continued)**

**Symptom Chart**

**Symptom Chart**

Condition	Possible Sources	Action
<ul style="list-style-type: none"> <li>DTC B2517 Emergency Power Off System Faulted</li> </ul>	<ul style="list-style-type: none"> <li>Fuse.</li> <li>Interface adapter assembly (IAA) module.</li> <li>Circuit(s).</li> <li>Inertia switch.</li> <li>High-voltage power distribution box (HVPDB).</li> <li>Power steering assembly.</li> <li>Contactors box.</li> <li>High-voltage harness (14B322).</li> </ul>	<ul style="list-style-type: none"> <li>GO to Pinpoint Test A.</li> </ul>
<ul style="list-style-type: none"> <li>Vehicle Will Not Start (Power Reset Indicator Illuminated)</li> </ul>	<ul style="list-style-type: none"> <li>Inertia switch.</li> <li>Interface adapter assembly (IAA) module.</li> </ul>	<ul style="list-style-type: none"> <li>GO to Pinpoint Test B.</li> </ul>

**Pinpoint Tests**

**Special Tool(s)**

**Special Tool(s)**

104-Pin Breakout Box (BOB) 418-049 (014-00950) or equivalent
BCM/TIM Breakout Box (BOB) Adapter Cable 418-F212

BCM/TIM Breakout Box (BOB) Overlay 418-F220
Traction Battery High-Voltage Service Cord 418-F218
Traction Battery Low-Voltage Service Cord 418-F219
Traction Battery High-Voltage Lockout and Diagnostic Tool 418-F207

(Continued)

**PINPOINT TEST A: DTC B2517 EMERGENCY POWER OFF SYSTEM FAULTED**

TEST STEP	ACTION TO TAKE
<b>A1 CHECK FUSE</b> <ul style="list-style-type: none"> <li>Check 15A fuse 7 in the electric vehicle power distribution box (EVPDB).</li> <li><b>Is the fuse OK?</b></li> </ul>	Yes = GO to <b>A2</b> .  No = REPLACE the fuse. If fuse fails again, CHECK/REPAIR for a short to ground.
<b>A2 CHECK BATTERY CONTROL MODULE (BCM) EMERGENCY POWER OFF (EPO) STATUS</b> <ul style="list-style-type: none"> <li>With key ON, monitor BCM PID EMG_PO.</li> <li><b>Does the EMG_PO PID indicate ENABLE?</b></li> </ul>	Yes = GO to <b>A5</b> . No = GO to <b>A3</b> .
<b>A3 CHECK EPO DISABLE SIGNAL TO IAA MODULE</b> <ul style="list-style-type: none"> <li>Connect 104-Pin Breakout Box (BOB) to IAA module C1945; leave IAA module disconnected.</li> <li>With key ON, measure the voltage between BOB pin 91 and ground (BOB pin 80).</li> <li><b>Is the voltage greater than 10 volts?</b></li> </ul>	Yes = REPLACE the IAA module. REFER to Section 412-04. No = GO to <b>A4</b> .
<b>A4 CHECK EPO DISABLE SIGNAL TO TRACTION BATTERY SUPPORT TRAY</b> <ul style="list-style-type: none"> <li>Disconnect BOB and reconnect IAA module C1945.</li> </ul>	Yes = REPAIR circuit 3006 (P/LG wire) between the IAA module and in-line C1939M.



(Continued)

**DIAGNOSIS AND TESTING (Continued)****PINPOINT TEST A: DTC B2517 EMERGENCY POWER OFF SYSTEM FAULTED**

<b>TEST STEP</b>	<b>ACTION TO TAKE</b>
<ul style="list-style-type: none"> <li>With key OFF, disconnect traction battery support tray in-line C1939 and connect BOB to traction battery support tray in-line C1939F and in-line C1939M using Traction Battery Low-Voltage Service Cord.</li> <li>With key ON, measure the voltage between BOB pin 19 and ground (BOB pin 65).</li> <li><b>Is the voltage greater than 10 volts?</b></li> </ul>	No = REMOVE the traction battery and REPAIR circuit 3006 (P/LG wire) between the contactor box and traction battery support tray in-line C1939F.
<b>A5 CHECK TRACTION INVERTER MODULE (TIM) EMERGENCY POWER OFF (EPO) STATUS</b> <ul style="list-style-type: none"> <li>With key ON, monitor TIM PID EMG_PO.</li> <li><b>Does the EMG_PO PID indicate ENABLE?</b></li> </ul>	Yes = GO to A13. No = GO to A6.
<b>A6 CHECK POWER TO IN-LINE C1948</b> <ul style="list-style-type: none"> <li>With key OFF, disconnect two-pin in-line C1948 (located behind the high-voltage power distribution box ) and measure the voltage between the O wire on in-line C1948F and ground.</li> <li><b>Is the voltage greater than 10 volts?</b></li> </ul>	Yes = RECONNECT in-line C1948. GO to A9. No = GO to A7.
<b>A7 CHECK POWER TO INERTIA SWITCH</b> <ul style="list-style-type: none"> <li>With key OFF, disconnect inertia switch C249 and measure the voltage between the LB/W wire on inertia switch C249 and ground.</li> <li><b>Is the voltage greater than 10 volts?</b></li> </ul>	Yes = GO to A8. No = REPAIR the LB/W wire.
<b>A8 CHECK INERTIA SWITCH</b> <ul style="list-style-type: none"> <li>Measure the resistance between the LB/W wire terminal and O wire terminal on the inertia switch with the inertia switch in the deactivated (depressed) position.</li> <li><b>Is the resistance less than 5 ohms?</b></li> </ul>	Yes = REPAIR the O wire between the inertia switch and in-line C1948F. No = REPLACE the inertia switch.
<b>A9 CHECK POWER TO TRACTION BATTERY SUPPORT TRAY</b> <ul style="list-style-type: none"> <li>With key OFF, disconnect high-voltage auxiliary load in-line C1935 on the traction battery support tray and measure the voltage between the R wire on in-line C1935M and ground.</li> <li><b>Is the voltage greater than 10 volts?</b></li> </ul>	Yes = GO to A12. No = GO to A10.
<b>A10 CHECK POWER TO POWER STEERING ASSEMBLY</b> <ul style="list-style-type: none"> <li>With key OFF, disconnect power steering assembly high-voltage C1895 and measure the voltage between the DG wire on power steering assembly C1895 and ground.</li> <li><b>Is the voltage greater than 10 volts?</b></li> </ul>	Yes = GO to A11. No = REPLACE the HVPDB.
<b>A11 CHECK POWER STEERING ASSEMBLY INTERLOCK JUMPER</b> <ul style="list-style-type: none"> <li>With key OFF, measure the resistance between the DG wire terminal and R wire terminal on the power steering assembly.</li> <li><b>Is the resistance less than 5 ohms?</b></li> </ul>	Yes = REPLACE the HVPDB. No = REPLACE the power steering assembly.
<b>A12 CHECK POWER TO CONTACTOR BOX</b> <ul style="list-style-type: none"> <li>Remove the traction battery and connect Traction Battery High-Voltage Lockout and Diagnostic Tool to the traction battery high-voltage two-pin C3994M.</li> <li>Connect Traction Battery High-Voltage Service Cord to high-voltage auxiliary load in-line C1935F on the traction battery support tray and in-line C1935M.</li> </ul>	Yes = REPLACE the contactor box. No = REPAIR the R wire between the contactor box and in-line C1935F.

(Continued)

**DIAGNOSIS AND TESTING (Continued)****PINPOINT TEST A: DTC B2517 EMERGENCY POWER OFF SYSTEM FAULTED**

TEST STEP	ACTION TO TAKE
<p> <b>WARNING: The traction battery contains high-voltage components and wiring. High-voltage insulated safety gloves and face shield must be worn when performing the following steps. Failure to follow this warning may result in severe personal injury or death.</b></p> <ul style="list-style-type: none"> <li>• <b>NOTE:</b> Contactor box C3985 is mounted on the passenger side of the BCM. With key OFF, disconnect contactor box C3985 and measure the voltage between the R wire on contactor box C3985 and ground.</li> <li>• <b>Is the voltage greater than 10 volts?</b></li> </ul>	
<p><b>A13 CHECK POWER TO TRACTION INVERTER MODULE (TIM) TWO-PIN HIGH-VOLTAGE CONNECTOR</b></p> <ul style="list-style-type: none"> <li>• With key OFF, disconnect traction battery high-voltage two-pin C3994.</li> <li>• With key OFF, measure the voltage between both interlock pins on the traction battery support tray C3994M and ground.</li> <li>• <b>Is the voltage greater than 10 volts on one of the interlock pins?</b></li> </ul>	<p>Yes = GO to <b>A15</b>. No = GO to <b>A14</b>.</p>
<p><b>A14 CHECK POWER TO TRACTION BATTERY SUPPORT TRAY</b></p> <ul style="list-style-type: none"> <li>• With key OFF, disconnect traction battery support tray in-line C1939 and connect BOB to traction battery support tray in-line C1939F and in-line C1939M using Traction Battery Low-Voltage Service Cord.</li> <li>• With key OFF, measure the voltage between BOB pin 47 and ground (BOB pin 65).</li> <li>• <b>Is the voltage greater than 10 volts?</b></li> </ul>	<p>Yes = REMOVE the traction battery and REPAIR circuit 974 (O wire) between traction battery support tray in-line C1939F and traction battery support tray C3994M. No = REPAIR circuit 974 (O wire) between in-line C1939M and S1963.</p>
<p><b>A15 CHECK TIM HIGH-VOLTAGE TWO-PIN CONNECTOR INTERLOCK FOR OPEN</b></p> <ul style="list-style-type: none"> <li>• With key OFF, measure the resistance between the interlock pins on TIM high-voltage two-pin C3994F.</li> <li>• <b>Is the resistance less than 5 ohms?</b></li> </ul>	<p>Yes = GO to <b>A16</b>. No = REPLACE the high-voltage harness (14B322) between the TIM and traction battery support tray.</p>
<p><b>A16 CHECK POWER TO CONTACTOR BOX</b></p> <ul style="list-style-type: none"> <li>• Remove the traction battery and connect Traction Battery High-Voltage Lockout and Diagnostic Tool to the traction battery high-voltage two-pin C3994M.</li> <li>• Connect Traction Battery High-Voltage Service Cord to traction battery support tray in-line C1935F and in-line C1935M.</li> </ul> <p> <b>WARNING: The traction battery contains high-voltage components and wiring. High-voltage insulated safety gloves and face shield must be worn when performing the following steps. Failure to follow this warning may result in severe personal injury or death.</b></p> <ul style="list-style-type: none"> <li>• Connect Traction Battery Low-Voltage Service Cord to traction battery support tray in-line C1939F and in-line C1939M.</li> <li>• With key OFF, disconnect contactor box C1982 and measure the voltage between pin 6 (Y wire) on contactor box C1982 and ground.</li> <li>• <b>Is the voltage greater than 10 volts?</b></li> </ul>	<p>Yes = REPLACE the contactor box. No = REPAIR the Y wire between the contactor box and traction battery support tray C3994M.</p>



**DIAGNOSIS AND TESTING (Continued)****PINPOINT TEST B: VEHICLE WILL NOT START (POWER RESET INDICATOR ILLUMINATED)**

TEST STEP	ACTION TO TAKE
<b>B1 CHECK FOR ACTIVATED INERTIA SWITCH</b> <ul style="list-style-type: none"> <li>• Check the inertia switch.</li> <li>• <b>Is the inertia switch activated?</b></li> </ul>	Yes = RESET the inertia switch. No = GO to <b>B2</b> .
<b>B2 CHECK INERTIA SWITCH</b> <ul style="list-style-type: none"> <li>• With key OFF, disconnect inertia switch C249 and measure the resistance between the LB/W wire terminal and W wire terminal on the inertia switch with the inertia switch in the deactivated (depressed) position.</li> <li>• <b>Is the resistance less than 5 ohms?</b></li> </ul>	Yes = REPLACE the inertia switch.  No = REPLACE the interface adapter assembly (IAA) module.

**Contactor Box Current Sensors****Diagnostic Trouble Code (DTC) Definition**

The following DTC relates to the main and auxiliary current sensors in the contactor box:

- DTC C1835 Current Sense Circuit Failure
  - The battery control module (BCM) uses the main current sensor to monitor the current flowing through the main high-voltage bus during the drive cycle and the auxiliary current sensor to monitor the current flowing through the auxiliary high-voltage bus during the charge and drive cycles. The BCM sets DTC C1835 if the main or auxiliary current sensors fall out of range at any time. Out of range is considered to be below 2.5 milliamps or above 45 milliamps. The BCM also sets DTC C1835 for the main current sensor if the current estimate from the traction inverter module (TIM) is 50 amps greater than the current reading from the main current sensor.

**Electrical Schematic**

Refer to Electrical and Vacuum Troubleshooting Manual, Cell 16, Traction Battery System for schematic and connector information.

**Inspection and Verification**

Refer to [Section 100-07](#).

**DIAGNOSIS AND TESTING (Continued)**

**Symptom Chart**

**Symptom Chart**

Condition	Possible Sources	Action
<ul style="list-style-type: none"> <li>DTC C1835 Current Sense Circuit Failure</li> </ul>	<ul style="list-style-type: none"> <li>Circuit(s).</li> <li>Contactor box.</li> <li>Battery control module (BCM).</li> </ul>	<ul style="list-style-type: none"> <li>GO to Pinpoint Test A.</li> </ul>

**Pinpoint Tests**

**Special Tool(s)**

104-Pin Breakout Box (BOB) 418-049 (014-00950) or equivalent
BCM/TIM Breakout Box (BOB) Adapter Cable 418-F212
BCM/TIM Breakout Box (BOB) Overlay 418-F220

(Continued)

**Special Tool(s)**



Traction Battery High-Voltage Service Cord 418-F218
Traction Battery Low-Voltage Service Cord 418-F219
Traction Battery High-Voltage Lockout and Diagnostic Tool 418-F207
High-Voltage Insulated Safety Gloves 100-F036 or equivalent
Face Shield 100-F035 or equivalent

**PINPOINT TEST A: DTC C1835 CURRENT SENSE CIRCUIT FAILURE**

TEST STEP	ACTION TO TAKE
<b>A1 CHECK STATUS OF CONTACTOR BOX AUXILIARY CURRENT SENSOR</b> <ul style="list-style-type: none"> <li>With key ON, monitor battery control module (BCM) PID AUX__SEN.</li> <li><b>Does the AUX__SEN PID indicate between 0.5 and 4.5 volts?</b></li> </ul>	Yes = GO to <b>A2</b> . No = GO to <b>A4</b> .
<b>A2 CHECK STATUS OF CONTACTOR BOX MAIN CURRENT SENSOR</b> <ul style="list-style-type: none"> <li>With key ON, monitor BCM PID MAINSEN.</li> <li><b>Does the MAINSEN PID indicate between 0.5 and 4.5 volts?</b></li> </ul>	Yes = GO to <b>A3</b> . No = GO to <b>A8</b> .
<b>A3 CHECK STATUS OF CONTACTOR BOX MAIN CURRENT SENSOR WHILE DRIVING</b> <ul style="list-style-type: none"> <li>Lift the vehicle on a hoist. Refer to Section 100-02.</li> <li>Start the vehicle, move the transmission range selector lever to the drive (D) position, and depress/release the accelerator pedal two or three times while monitoring BCM PID MAINSEN.</li> <li><b>Does the MAINSEN PID voltage increase upon acceleration?</b></li> </ul>	Yes = GO to <b>A12</b> .  No = REPLACE the contactor box.
<b>A4 CHECK AUXILIARY CURRENT SENSOR SIGNAL TO BCM</b> <ul style="list-style-type: none"> <li>Remove the traction battery and connect Traction Battery High-Voltage Lockout and Diagnostic Tool to the traction battery high-voltage two-pin C3994M.</li> </ul>	Yes = REPLACE the BCM.

(Continued)

**DIAGNOSIS AND TESTING (Continued)****PINPOINT TEST A: DTC C1835 CURRENT SENSE CIRCUIT FAILURE**

TEST STEP	ACTION TO TAKE
<p> <b>WARNING: The traction battery contains high-voltage components and wiring. High-voltage insulated safety gloves and face shield must be worn when performing the following steps. Failure to follow this warning may result in severe personal injury or death.</b></p> <ul style="list-style-type: none"> <li>• Connect Traction Battery High-Voltage Service Cord to traction battery support tray in-line C1935F and in-line C1935M.</li> <li>• Connect Traction Battery Low-Voltage Service Cord to traction battery support tray in-line C1939F and in-line C1939M.</li> <li>• Connect 104-Pin Breakout Box (BOB) to BCM C1986, C1987 using the BCM/TIM BOB Adapter Cable and Overlay; leave the BCM disconnected.</li> <li>• With key ON, measure the voltage between BOB pin A17 and ground (BOB pin A33).</li> <li>• <b>Is the voltage between 5 and 8 volts?</b></li> </ul>	<p>No = GO to A5.</p>
<p><b>A5 CHECK CIRCUITS 3996 (R/Y) AND 3705 (LB) FOR OPEN(S)</b></p> <ul style="list-style-type: none"> <li>• With key OFF, disconnect contactor box C1982 and measure the resistance of the R/Y wire between pin 21 on contactor box C1982 and BOB pin A16.</li> <li>• With key OFF, measure the resistance of the LB wire between pin 22 on contactor box C1982 and BOB pin A17.</li> <li>• <b>Are the resistances less than 5 ohms?</b></li> </ul>	<p>Yes = GO to A6.</p> <p>No = REPAIR the wire(s) in question.</p>
<p><b>A6 CHECK CIRCUIT 3705 (LB) FOR SHORT TO GROUND</b></p> <ul style="list-style-type: none"> <li>• With key OFF, measure the resistance between BOB pin A17 and ground (BOB pin A33).</li> <li>• <b>Is the resistance greater than 10,000 ohms?</b></li> </ul>	<p>Yes = GO to A7.</p> <p>No = REPAIR the LB wire.</p>
<p><b>A7 CHECK CIRCUIT 3705 (LB) FOR SHORT TO POWER</b></p> <ul style="list-style-type: none"> <li>• With key ON, measure the voltage between BOB pin A17 and ground (BOB pin A33).</li> <li>• <b>Is the voltage greater than 0 volts?</b></li> </ul>	<p>Yes = REPAIR the LB wire.</p> <p>No = REPLACE the contactor box.</p>
<p><b>A8 CHECK MAIN CURRENT SENSOR SIGNAL TO BCM</b></p> <ul style="list-style-type: none"> <li>• Remove the traction battery and connect Traction Battery High-Voltage Lockout and Diagnostic Tool to the traction battery high-voltage two-pin C3994M.</li> </ul> <p> <b>WARNING: The traction battery contains high-voltage components and wiring. High-voltage insulated safety gloves and face shield must be worn when performing the following steps. Failure to follow this warning may result in severe personal injury or death.</b></p> <ul style="list-style-type: none"> <li>• Connect Traction Battery High-Voltage Service Cord to traction battery support tray in-line C1935F and in-line C1935M.</li> <li>• Connect Traction Battery Low-Voltage Service Cord to traction battery support tray in-line C1939F and in-line C1939M.</li> <li>• Connect 104-Pin Breakout Box (BOB) to BCM C1986, C1987 using the BCM/TIM BOB Adapter Cable and Overlay; leave the BCM disconnected.</li> <li>• With key ON, measure the voltage between BOB pin A15 and ground (BOB pin A33).</li> <li>• <b>Is the voltage between 5 and 8 volts?</b></li> </ul>	<p>Yes = REPLACE the BCM.</p> <p>No = GO to A9.</p>
<p><b>A9 CHECK CIRCUITS 3602 (T/Y) AND 3706 (DB) FOR OPEN(S)</b></p> <ul style="list-style-type: none"> <li>• With key OFF, disconnect contactor box C1982 and measure the resistance of the T/Y wire between pin 23 on contactor box C1982 and BOB pin B1.</li> </ul>	<p>Yes = GO to A10.</p>

(Continued)

**DIAGNOSIS AND TESTING (Continued)****PINPOINT TEST A: DTC C1835 CURRENT SENSE CIRCUIT FAILURE**

<b>TEST STEP</b>	<b>ACTION TO TAKE</b>
<ul style="list-style-type: none"> <li>With key OFF, measure the resistance of the DB wire between pin 15 on contactor box C1982 and BOB pin A15.</li> <li><b>Are the resistances less than 5 ohms?</b></li> </ul>	No = REPAIR the wire(s) in question.
<b>A10 CHECK CIRCUIT 3706 (DB) FOR SHORT TO GROUND</b> <ul style="list-style-type: none"> <li>With key OFF, measure the resistance between BOB pin A15 and ground (BOB pin A33).</li> <li><b>Is the resistance greater than 10,000 ohms?</b></li> </ul>	Yes = GO to <b>A11</b> . No = REPAIR the DB wire.
<b>A11 CHECK CIRCUIT 3706 (DB) FOR SHORT TO POWER</b> <ul style="list-style-type: none"> <li>With key ON, measure the voltage between BOB pin A15 and ground (BOB pin A33).</li> <li><b>Is the voltage greater than 0 volts?</b></li> </ul>	Yes = REPAIR the DB wire. No = REPLACE the contactor box.
<b>A12 CHECK CURRENT SENSE CONTROL DISABLE SIGNAL</b> <ul style="list-style-type: none"> <li>Remove the traction battery and connect Traction Battery High-Voltage Lockout and Diagnostic Tool to the traction battery high-voltage two-pin C3994M.</li> </ul> <p> <b>WARNING: The traction battery contains high-voltage components and wiring. High-voltage insulated safety gloves and face shield must be worn when performing the following steps. Failure to follow this warning may result in severe personal injury or death.</b></p> <ul style="list-style-type: none"> <li>Connect Traction Battery High-Voltage Service Cord to traction battery support tray in-line C1935F and in-line C1935M.</li> <li>Connect Traction Battery Low-Voltage Service Cord to traction battery support tray in-line C1939F and in-line C1939M.</li> <li>Connect 104-Pin Breakout Box (BOB) to BCM and BCM C1986, C1987 using the BCM/TIM BOB Adapter Cable and Overlay.</li> <li>Enter BCM active command mode BCM PACKETED COMMANDS, set the active command CURRENT S to DISABLE, and measure the voltage between BOB pin B22 and ground (BOB pin A33).</li> <li><b>Is the voltage greater than 7.5 volts?</b></li> </ul>	Yes = GO to <b>A13</b> . No = GO to <b>A15</b> .
<b>A13 CHECK CURRENT SENSE CONTROL ENABLE SIGNAL</b> <ul style="list-style-type: none"> <li>Set the active command CURRENT S to ENABLE and measure the voltage between BOB pin B22 and ground (BOB pin A33).</li> <li><b>Is the voltage less than 1 volt?</b></li> </ul>	Yes = System OK. CHECK wiring for intermittent connections. No = GO to <b>A14</b> .
<b>A14 CHECK CIRCUIT 3138 (LB/BK) FOR SHORT TO POWER</b> <ul style="list-style-type: none"> <li>With key OFF, disconnect the BOB from the BCM; leave BOB connected to BCM C1986 and C1987.</li> <li>With key OFF, disconnect contactor box C1982.</li> <li>With key ON, measure the voltage between BOB pin B22 and ground (BOB pin A33).</li> <li><b>Is the voltage greater than 0 volts?</b></li> </ul>	Yes = REPAIR the LB/BK wire. No = REPLACE the BCM.
<b>A15 CHECK CONTACTOR BOX SIGNAL TO BCM</b> <ul style="list-style-type: none"> <li>With key OFF, disconnect the BOB from the BCM; leave BOB connected to BCM C1986 and C1987.</li> <li>With key ON, measure the voltage between BOB pin B22 and ground (BOB pin A33).</li> <li><b>Is the voltage between 7.5 and 9 volts?</b></li> </ul>	Yes = REPLACE the BCM. No = GO to <b>A16</b> .
<b>A16 CHECK CIRCUIT 3138 (LB/BK) FOR OPEN</b> <ul style="list-style-type: none"> <li>With key OFF, disconnect contactor box C1982 and measure the resistance of the LB/BK wire between pin 12 on contactor box C1982 and BOB pin B22.</li> </ul>	Yes = GO to <b>A17</b> .

(Continued)

**DIAGNOSIS AND TESTING (Continued)****PINPOINT TEST A: DTC C1835 CURRENT SENSE CIRCUIT FAILURE**

TEST STEP	ACTION TO TAKE
<ul style="list-style-type: none"> <li>Is the resistance less than 5 ohms?</li> </ul>	No = REPAIR the LB/BK wire.
<b>A17 CHECK CIRCUIT 3138 (LB/BK) FOR SHORT TO GROUND</b> <ul style="list-style-type: none"> <li>With key OFF, measure the resistance between BOB pin B22 and ground (BOB pin A33).</li> <li>Is the resistance greater than 10,000 ohms?</li> </ul>	Yes = REPLACE the contactor box. No = REPAIR the LB/BK wire.

**Current Leakage Detection****Diagnostic Trouble Code (DTC) Definition**

The following DTC relates to current leakage detection:

- DTC C1839 Leakage Fault
  - Current leakage is a low level of impedance between vehicle chassis and either traction battery positive (TB+) or traction battery negative (TB-). The battery control module (BCM) checks for a parallel combination of bus leakage impedance (between vehicle chassis and TB+, and between vehicle chassis and TB-) during the charge and drive cycles. The BCM sets DTC C1839 when it detects a low level of leakage (between 10,000 and 50,000 ohms) during charging, high level leakage (less than 10,000 ohms) during charging, leakage (less than 50,000 ohms) during driving, or if the leakage circuit fails. The BCM uses PIDs to indicate when the leakage occurred, the severity of the leakage when it occurred, and the status of the leakage circuits.

**Electrical Schematic**

Refer to Electrical and Vacuum Troubleshooting Manual, Cell 16, Traction Battery System for schematic and connector information.

**Inspection and Verification**

Refer to [Section 100-07](#).

**DIAGNOSIS AND TESTING (Continued)**

**Symptom Chart**

**Symptom Chart**

Condition	Possible Sources	Action
<ul style="list-style-type: none"> <li>DTC C1839 Leakage Fault</li> </ul>	<ul style="list-style-type: none"> <li>High-voltage harness (10B694).</li> <li>High-voltage harness(es) (14A280).</li> <li>Battery control module (BCM).</li> <li>A/C inverter motor controller (IMC).</li> <li>A/C compressor.</li> <li>Traction inverter module (TIM).</li> <li>Motor/transaxle.</li> <li>Lower battery heater.</li> <li>High-voltage harness (10B700).</li> <li>Upper battery heater.</li> <li>Contactor box.</li> <li>Power steering assembly.</li> <li>Positive temperature coefficient (PTC) heater.</li> <li>PTC switching module.</li> <li>DC/DC converter.</li> <li>High-voltage power distribution box (HVPDB).</li> <li>Traction battery charger.</li> <li>High-voltage harness (14B322).</li> </ul>	<ul style="list-style-type: none"> <li>GO to Pinpoint Test A.</li> </ul>

**Pinpoint Tests**

**Special Tool(s)**

104-Pin Breakout Box (BOB) 418-049 (014-00950) or equivalent
Traction Battery High-Voltage Lockout and Diagnostic Tool 418-F207
Power Steering Interlock Tool 211-F006

(Continued)

**Special Tool(s)**

Auxiliary Interlock Tool 418-F208
Traction Battery High-Voltage Service Cord 418-F218
Traction Battery Low-Voltage Service Cord 418-F219
High-Voltage Insulated Safety Gloves 100-F036 or equivalent
Face Shield 100-F035 or equivalent

**PINPOINT TEST A: DTC C1839 LEAKAGE FAULT**

TEST STEP	ACTION TO TAKE
<p><b>A1 CHECK FOR CURRENT LEAKAGE</b></p> <ul style="list-style-type: none"> <li>With key ON, monitor battery control module (BCM) PIDs LEAK__DF, LEAKHCF, and LEAKLCF.</li> <li>Wait approximately 50 seconds.</li> <li><b>Do any of the PIDs indicate YES?</b></li> </ul>	<p>Yes = GO to <b>A7</b> (leakage is in vehicle somewhere).</p> <p>No = GO to <b>A2</b> (leakage circuit failure).</p>
<p><b>A2 CHECK FOR LEAKAGE CIRCUIT FAILURE</b></p> <ul style="list-style-type: none"> <li>With key ON, monitor BCM PID LEAK__CF.</li> <li>Wait approximately two minutes.</li> </ul>	<p>Yes = GO to <b>A3</b>.</p>

(Continued)

**DIAGNOSIS AND TESTING (Continued)****PINPOINT TEST A: DTC C1839 LEAKAGE FAULT**

<b>TEST STEP</b>	<b>ACTION TO TAKE</b>
<ul style="list-style-type: none"> <li>Does the LEAK_CF PID indicate YES?</li> </ul>	No = CLEAR the BCM DTCs. DRIVE the vehicle. If the electrical hazard warning indicator illuminates and DTC C1839 still occurs, REPEAT test steps A1 and A2. If all PIDs still indicate NO, REPLACE the BCM. Otherwise, continue as indicated.
<b>A3 CHECK LOW-LEVEL CURRENT LEAKAGE CIRCUIT 3213 (BK/LB) BETWEEN IN-LINE C1882M AND BCM FOR OPEN</b> <ul style="list-style-type: none"> <li>Remove the traction battery and connect Traction Battery High-Voltage Lockout and Diagnostic Tool to the traction battery high-voltage two-pin C3994M.</li> <li>Connect Traction Battery High-Voltage Service Cord to traction battery support tray in-line C1935F and in-line C1935M.</li> </ul> <p><b>⚠ WARNING: The traction battery contains high-voltage components and wiring. High-voltage insulated safety gloves and face shield must be worn when performing the following steps. Failure to follow this warning may result in severe personal injury or death.</b></p> <ul style="list-style-type: none"> <li>Connect Traction Battery Low-Voltage Service Cord to traction battery support tray in-line C1939F and in-line C1939M.</li> <li>With key OFF, disconnect BCM high-voltage C1865.</li> <li>With key OFF, disconnect in-line C1882 (label R) and measure the resistance of the BK/LB wire between pin 7 on BCM high-voltage C1865 and in-line C1882M.</li> <li>Is the resistance less than 5 ohms?</li> </ul>	Yes = GO to A4.  No = REPLACE high-voltage harness (10B694).
<b>A4 CHECK LOW-LEVEL CURRENT LEAKAGE CIRCUIT BETWEEN IN-LINE C1882F AND BATTERY MODULE 1 FOR OPEN</b> <ul style="list-style-type: none"> <li>With key OFF, measure the resistance between the BK/LB wire on in-line C1882F and battery module 1 negative (-) post.</li> <li>Is the resistance between 28,000 and 34,000 ohms?</li> </ul>	Yes = GO to A5.  No = REPLACE high-voltage harness (14A280-RF).
<b>A5 CHECK HIGH-LEVEL CURRENT LEAKAGE CIRCUIT 3212 (DB) BETWEEN IN-LINE C1885M AND BCM FOR OPEN</b> <ul style="list-style-type: none"> <li>With key OFF, disconnect BCM high-voltage C1866.</li> <li>With key OFF, disconnect in-line C1885 (label W) and measure the resistance of the DB wire between pin 40 on BCM high-voltage C1866 and in-line C1885M.</li> <li>Is the resistance less than 5 ohms?</li> </ul>	Yes = GO to A6. No = REPLACE high-voltage harness (10B694).
<b>A6 CHECK HIGH LEVEL CURRENT LEAKAGE CIRCUIT 3212 (DB) BETWEEN IN-LINE C1885F AND BATTERY MODULE 39 FOR OPEN</b>	

(Continued)

**DIAGNOSIS AND TESTING (Continued)****PINPOINT TEST A: DTC C1839 LEAKAGE FAULT**

TEST STEP	ACTION TO TAKE
<ul style="list-style-type: none"> <li>• With key OFF, measure the resistance between the DB wire on in-line C1885F and battery module 39 positive (+) post.</li>   <li>• <b>Is the resistance between 28,000 and 34,000 ohms?</b></li> </ul>	<p>Yes = CLEAR the BCM DTCs. DRIVE the vehicle. If the electrical hazard warning indicator illuminates and DTC C1839 still occurs, REPEAT test steps A1 and A2. If all PIDs still indicate NO, REPLACE the BCM. Otherwise, continue as indicated.</p> <p>No = REPLACE high-voltage harness (14A280-WD).</p>
<p><b>A7 CHECK PARALLEL COMBINATION (TB+ AND TB-) OF CURRENT LEAKAGE RESISTANCE</b></p> <ul style="list-style-type: none"> <li>• With key ON, monitor BCM PID LEAKRES.</li> <li>• Wait approximately 50 seconds.</li> <li>• <b>Does the LEAKRES PID indicate less than 50,000 ohms?</b></li> </ul>	<p>Yes = GO to A9.</p> <p>No = GO to A8.</p>
<p><b>A8 CHECK FOR CURRENT LEAKAGE IN TRACTION BATTERY CHARGER POSITIVE (+) BUS</b></p> <ul style="list-style-type: none"> <li>• With key ON, enter BCM active command mode CONTACTOR OUTPUT CONTROL, monitor BCM PID LKRESB+, and set the active command CHARGER to CLOSE.</li> <li>• Wait approximately 50 seconds.</li> <li>• <b>Does the LKRESB+ PID indicate less than 50,000 ohms?</b></li> </ul>	<p>Yes = GO to A59.</p> <p>No = GO to A11.</p>
<p><b>A9 CHECK FOR CURRENT LEAKAGE IN THE HIGH-VOLTAGE NEGATIVE BUS (TB-)</b></p> <ul style="list-style-type: none"> <li>• With key ON, monitor BCM PID LKRESB- (current leakage measurement between TB- and chassis ground).</li> <li>• Wait approximately 50 seconds.</li> <li>• <b>Does the LKRESB- PID indicate less than 50,000 ohms?</b></li> </ul>	<p>Yes = GO to A32 (leakage is in TB- bus).</p> <p>No = GO to A10.</p>
<p><b>A10 CHECK FOR CURRENT LEAKAGE IN THE HIGH-VOLTAGE POSITIVE BUS (TB+)</b></p> <ul style="list-style-type: none"> <li>• With key ON, monitor BCM PID LKRESB+ (current leakage measurement between TB+ and chassis ground).</li> <li>• Wait approximately 50 seconds.</li> <li>• <b>Does the LKRESB+ PID indicate less than 50,000 ohms?</b></li> </ul>	<p>Yes = GO to A49 (leakage is in TB+ bus).</p> <p>No = GO to A16.</p>
<p><b>A11 CHECK FOR CURRENT LEAKAGE IN THE TRACTION MOTOR</b></p> <ul style="list-style-type: none"> <li>• Raise the vehicle on a hoist.</li> </ul>	<p>Yes = GO to A14 (leakage is in TIM or traction motor).</p>

(Continued)



**DIAGNOSIS AND TESTING (Continued)****PINPOINT TEST A: DTC C1839 LEAKAGE FAULT**

<b>TEST STEP</b>	<b>ACTION TO TAKE</b>
<ul style="list-style-type: none"> <li>• Turn the ignition key to the START position, set the gear selector lever to the drive (D) position, and monitor BCM PID LEAKRES.</li> <li>• Wait approximately 50 seconds.</li> <li>• <b>Does the LEAKRES PID indicate less than 50,000 ohms?</b></li> </ul>	No = If vehicle is equipped with A/C, GO to <b>A12</b> . If not, CLEAR the BCM DTCs. DRIVE the vehicle. If the electrical hazard warning indicator illuminates and DTC C1839 still occurs, REPEAT test steps A1 and A2. If all PIDs still indicate NO, CHECK the traction battery support tray for excessive moisture or water build-up. If OK, REPLACE the BCM.
<b>A12 CHECK FOR CURRENT LEAKAGE IN A/C INVERTER MOTOR CONTROLLER (IMC) OR A/C COMPRESSOR</b> <ul style="list-style-type: none"> <li>• Depress the brake pedal and set the gear selector lever to the park (P) position.</li> <li>• With key ON, set the mode select knob to the A/C position, the temperature control knob to the full cool position, and the blower control knob to the high speed position, and monitor BCM PID LEAKRES.</li> <li>• Wait approximately 50 seconds.</li> <li>• <b>Does the LEAKRES PID indicate less than 50,000 ohms?</b></li> </ul>	Yes = GO to <b>A13</b> .  No = CLEAR the BCM DTCs. DRIVE the vehicle. If the electrical hazard warning indicator illuminates and DTC C1839 still occurs, REPEAT test steps A1 and A2. If all PIDs still indicate NO, CHECK the traction battery support tray for excessive moisture or water build-up. If OK, REPLACE the BCM.
<b>A13 CHECK FOR CURRENT LEAKAGE IN A/C COMPRESSOR</b> <ul style="list-style-type: none"> <li>• With key OFF, disconnect A/C inverter motor controller (IMC) high-voltage C1902 (to A/C compressor).</li> <li>• With key ON, monitor BCM PID LEAKRES.</li> <li>• Wait approximately 50 seconds.</li> <li>• <b>Does the LEAKRES PID indicate less than 50,000 ohms?</b></li> </ul>	Yes = REPLACE A/C IMC. REFER to Section 412-03.  No = REPLACE the A/C compressor. REFER to Section 412-03.
<b>A14 CHECK FOR CURRENT LEAKAGE IN TIM OR TRACTION MOTOR</b> <ul style="list-style-type: none"> <li>• With key OFF, disconnect the traction motor three-phase cables from the TIM, and reconnect the traction battery high-voltage two-pin C3994.</li> <li>• With key ON, monitor BCM PID LEAKRES.</li> <li>• Wait approximately 50 seconds.</li> <li>• <b>Does the LEAKRES PID indicate less than 50,000 ohms?</b></li> </ul>	Yes = GO to <b>A15</b> (leakage is in TIM or high-voltage cables to TIM).  No = REPLACE the motor/transaxle. REFER to Section 303-01.
<b>A15 CHECK FOR CURRENT LEAKAGE IN TIM OR HIGH-VOLTAGE CABLES LEADING TO TIM</b> <ul style="list-style-type: none"> <li>• With key OFF, check the high-voltage cables to the TIM to see if the positive (+) or negative (-) cables are touching chassis ground.</li> <li>• <b>Are any of the cables touching chassis ground?</b></li> </ul>	Yes = REPLACE high-voltage harness (14B322).  No = REPLACE the TIM. REFER to Section 303-14.
<b>A16 CHECK FOR CURRENT LEAKAGE IN TRACTION BATTERY SUPPORT TRAY, TRACTION INVERTER MODULE (TIM), MOTOR/TRANSAXLE, OR IN THE AUXILIARY NEGATIVE BUS FOR THE HIGH-VOLTAGE AUXILIARY LOAD COMPONENTS</b>	

(Continued)

**DIAGNOSIS AND TESTING (Continued)****PINPOINT TEST A: DTC C1839 LEAKAGE FAULT**

<b>TEST STEP</b>	<b>ACTION TO TAKE</b>
<ul style="list-style-type: none"> <li>• With key OFF, disconnect high-voltage auxiliary load in-line C1935 on the traction battery support tray.</li> <li>• Connect Auxiliary Interlock Tool to the high-voltage auxiliary load in-line C1935 on the traction battery support tray and in-line interlock C1948 (located behind the high voltage power distribution box ).</li> <li>• With key ON, monitor BCM PID LEAKRES.</li> <li>• Wait approximately 50 seconds.</li> <li>• <b>Does the LEAKRES PID indicate less than 50,000 ohms?</b></li> </ul>	<p>Yes = GO to <b>A24</b> (leakage is in traction battery support tray, TIM, or traction motor).</p> <p>No = GO to <b>A17</b> (leakage is in the auxiliary negative bus).</p>
<p><b>A17 CHECK FOR CURRENT LEAKAGE IN POWER STEERING ASSEMBLY</b></p> <ul style="list-style-type: none"> <li>• With key OFF, remove Auxiliary Interlock Tool, and reconnect in-line interlock C1948 and high-voltage auxiliary load in-line C1935 to the traction battery support tray.</li> <li>• With key OFF, disconnect power steering assembly high-voltage C1895.</li> <li>• Connect Power Steering Interlock Tool to power steering assembly C1895.</li> <li>• With key ON, monitor BCM PID LEAKRES.</li> <li>• Wait approximately 50 seconds.</li> <li>• <b>Does the LEAKRES PID indicate less than 50,000 ohms?</b></li> </ul>	<p>Yes = GO to <b>A18</b>.</p> <p>No = REPLACE the power steering assembly. REFER to Section 211-02.</p>
<p><b>A18 CHECK FOR CURRENT LEAKAGE IN A/C COMPRESSOR</b></p> <ul style="list-style-type: none"> <li>• With key OFF, disconnect A/C inverter motor controller (IMC) high-voltage C1902 (to A/C compressor).</li> <li>• With key ON, monitor BCM PID LEAKRES.</li> <li>• Wait approximately 50 seconds.</li> <li>• <b>Does the LEAKRES PID indicate less than 50,000 ohms?</b></li> </ul>	<p>Yes = GO to <b>A19</b>.</p> <p>No = REPLACE the A/C compressor. REFER to Section 412-03.</p>
<p><b>A19 CHECK FOR CURRENT LEAKAGE IN A/C IMC</b></p> <ul style="list-style-type: none"> <li>• With key OFF, remove the high voltage power distribution box (HVPDB) cover and disconnect HVPDB C1917 (to A/C IMC).</li> <li>• Reinstall the HVPDB cover.</li> <li>• With key ON, monitor BCM PID LEAKRES.</li> <li>• Wait approximately 50 seconds.</li> <li>• <b>Does the LEAKRES PID indicate less than 50,000 ohms?</b></li> </ul>	<p>Yes = GO to <b>A20</b>.</p> <p>No = REPLACE the A/C IMC. REFER to Section 412-03.</p>
<p><b>A20 CHECK FOR CURRENT LEAKAGE IN POSITIVE TEMPERATURE COEFFICIENT (PTC) HEATER</b></p> <ul style="list-style-type: none"> <li>• With key OFF, disconnect PTC switching module high-voltage C1912.</li> <li>• With key ON, monitor BCM PID LEAKRES.</li> <li>• Wait approximately 50 seconds.</li> <li>• <b>Does the LEAKRES PID indicate less than 50,000 ohms?</b></li> </ul>	<p>Yes = GO to <b>A21</b>.</p> <p>No = REPLACE the PTC heater. REFER to Section 412-02.</p>
<p><b>A21 CHECK FOR CURRENT LEAKAGE IN PTC SWITCHING MODULE</b></p> <ul style="list-style-type: none"> <li>• With key OFF, remove the HVPDB cover and disconnect HVPDB C1920 (to PTC switching module).</li> <li>• Reinstall the HVPDB cover.</li> <li>• With key ON, monitor BCM PID LEAKRES.</li> <li>• Wait approximately 50 seconds.</li> <li>• <b>Does the LEAKRES PID indicate less than 50,000 ohms?</b></li> </ul>	<p>Yes = GO to <b>A22</b>.</p> <p>No = REPLACE the PTC switching module. REFER to Section 412-02.</p>
<p><b>A22 CHECK FOR CURRENT LEAKAGE IN DC/DC CONVERTER</b></p> <ul style="list-style-type: none"> <li>• With key OFF, remove the HVPDB cover and disconnect HVPDB C1914 (to DC/DC converter).</li> </ul>	<p>Yes = GO to <b>A23</b>.</p>

(Continued)

**DIAGNOSIS AND TESTING (Continued)****PINPOINT TEST A: DTC C1839 LEAKAGE FAULT**

TEST STEP	ACTION TO TAKE
<ul style="list-style-type: none"> <li>• Reinstall the HVPDB cover.</li> <li>• With key ON, monitor BCM PID LEAKRES.</li> <li>• Wait approximately 50 seconds.</li> <li>• <b>Does the LEAKRES PID indicate less than 50,000 ohms?</b></li> </ul>	No = REPLACE the DC/DC converter. REFER to Section 414-02.
<b>A23 CHECK FOR CURRENT LEAKAGE IN TRACTION BATTERY CHARGER</b> <ul style="list-style-type: none"> <li>• With key OFF, remove the HVPDB cover and disconnect HVPDB C1923 (to traction battery charger).</li> <li>• Reinstall the HVPDB cover.</li> <li>• With key ON, monitor BCM PID LEAKRES.</li> <li>• Wait approximately 50 seconds.</li> <li>• <b>Does the LEAKRES PID indicate less than 50,000 ohms?</b></li> </ul>	Yes = REPLACE the HVPDB.  No = REPLACE the traction battery charger.
<b>A24 CHECK FOR CURRENT LEAKAGE IN TRACTION BATTERY SUPPORT TRAY, TIM, OR TRACTION MOTOR</b> <ul style="list-style-type: none"> <li>• With key OFF, disconnect the traction battery high-voltage two-pin C3994 and connect Traction Battery High-Voltage Lockout and Diagnostic Tool to the traction battery high-voltage two-pin C3994M.</li> <li>• With key ON, monitor BCM PID LEAKRES.</li> <li>• Wait approximately 50 seconds.</li> <li>• <b>Does the LEAKRES PID indicate less than 50,000 ohms?</b></li> </ul>	Yes = GO to <b>A27</b> (leakage is in traction battery support tray).  No = GO to <b>A25</b> (leakage is in TIM or traction motor).
<b>A25 CHECK FOR CURRENT LEAKAGE IN TIM OR TRACTION MOTOR</b> <ul style="list-style-type: none"> <li>• With key OFF, disconnect the traction motor three-phase cables from the TIM, and reconnect the traction battery high-voltage two-pin C3994.</li> <li>• With key ON, monitor BCM PID LEAKRES.</li> <li>• Wait approximately 50 seconds.</li> <li>• <b>Does the LEAKRES PID indicate less than 50,000 ohms?</b></li> </ul>	Yes = GO to <b>A26</b> (leakage is in TIM or high-voltage cables to TIM).  No = REPLACE the motor/transaxle. REFER to Section 303-01.
<b>A26 CHECK FOR CURRENT LEAKAGE IN TIM OR HIGH-VOLTAGE CABLES LEADING TO TIM</b> <ul style="list-style-type: none"> <li>• With key OFF, check the high-voltage cables to the TIM to see if the positive (+) or negative (-) cables are touching chassis ground.</li> <li>• <b>Are any of the cables touching chassis ground?</b></li> </ul>	Yes = REPLACE high-voltage harness (14B322).  No = REPLACE the TIM. REFER to Section 303-14.
<b>A27 CHECK FOR CURRENT LEAKAGE IN HIGH-VOLTAGE NEGATIVE BUS (TB-) (INSIDE TRACTION BATTERY SUPPORT TRAY)</b> <p><b>NOTE:</b> The BCM active command CHARGER must be sent before the BCM active command NEG MAIN is sent.</p> <ul style="list-style-type: none"> <li>• With key ON, enter BCM active command mode CONTACTOR OUTPUT CONTROL, monitor BCM PID LEAKRES, and set the active command CHARGER to CLOSE.</li> <li>• Set the active command NEG MAIN to OPEN.</li> <li>• Wait approximately 50 seconds.</li> <li>• <b>Does the LEAKRES PID indicate less than 50,000 ohms?</b></li> </ul>	Yes = GO to <b>A28</b> (leakage is in battery module voltage sense lines or contactor box).  No = GO to <b>A29</b> (leakage is in battery heater harness or contactor box).
<b>A28 CHECK FOR CURRENT LEAKAGE IN BATTERY MODULE VOLTAGE SENSE LINES</b> <ul style="list-style-type: none"> <li>• With key ON, monitor BCM PID LEAK__ID and note the indicated battery module.</li> </ul>	Yes = REPLACE high-voltage harness (10B694) and/or the high-voltage harness (14A280) in question.

(Continued)

**DIAGNOSIS AND TESTING (Continued)****PINPOINT TEST A: DTC C1839 LEAKAGE FAULT**

TEST STEP	ACTION TO TAKE
<p><b>NOTE:</b> If there is no continuity between the indicated battery module and chassis ground, check for continuity between chassis ground and the positive (+) posts of the two battery modules before and after the indicated battery module.</p> <ul style="list-style-type: none"> <li>• With key OFF, disconnect BCM C1865 and C1866, and check for continuity between the positive (+) post of the indicated battery module and chassis ground.</li> <li>• <b>Is there continuity?</b></li> </ul>	<p>No = REPLACE the contactor box.</p>
<p><b>A29 CHECK FOR CURRENT LEAKAGE IN CONTACTOR BOX OR BATTERY HEATER HARNESS (IF EQUIPPED)</b></p> <p><b>NOTE:</b> If vehicle is not equipped with traction battery heaters, REPLACE the contactor box.</p> <ul style="list-style-type: none"> <li>• Remove the traction battery and connect Traction Battery High-Voltage Lockout and Diagnostic Tool to the traction battery high-voltage two-pin C3994M.</li> <li>• Connect Traction Battery Low-Voltage Service Cord to traction battery support tray in-line C1939F and in-line C1939M.</li> </ul> <p> <b>WARNING: The traction battery contains high-voltage components and wiring. High-voltage insulated safety gloves and face shield must be worn when performing the following steps. Failure to follow this warning may result in severe personal injury or death.</b></p> <ul style="list-style-type: none"> <li>• With key OFF, disconnect contactor box C1864.</li> <li>• With key ON, monitor BCM PID LEAKRES.</li> <li>• Wait approximately 50 seconds.</li> <li>• <b>Does the LEAKRES PID indicate less than 50,000 ohms?</b></li> </ul>	<p>Yes = REPLACE the contactor box.</p> <p>No = GO to <b>A30</b> (leakage is in battery heater harness).</p>
<p><b>A30 CHECK FOR CURRENT LEAKAGE IN LOWER BATTERY HEATER</b></p> <ul style="list-style-type: none"> <li>• With key OFF, reconnect contactor box C1864 and disconnect lower battery heater C1862 and C1863.</li> <li>• With key ON, monitor BCM PID LEAKRES.</li> <li>• Wait approximately 50 seconds.</li> <li>• <b>Does the LEAKRES PID indicate less than 50,000 ohms?</b></li> </ul>	<p>Yes = GO to <b>A31</b>.</p> <p>No = REPLACE the lower battery heater.</p>
<p><b>A31 CHECK FOR CURRENT LEAKAGE IN UPPER BATTERY HEATER</b></p> <ul style="list-style-type: none"> <li>• With key OFF, disconnect upper battery heater C1859 and C1861.</li> <li>• With key ON, monitor BCM PID LEAKRES.</li> <li>• Wait approximately 50 seconds.</li> <li>• <b>Does the LEAKRES PID indicate less than 50,000 ohms?</b></li> </ul>	<p>Yes = REPLACE high-voltage harness (10B700).</p> <p>No = REPLACE the upper battery heater.</p>
<p><b>A32 CHECK FOR CURRENT LEAKAGE IN HIGH-VOLTAGE NEGATIVE BUS (TB-) (INSIDE TRACTION BATTERY SUPPORT TRAY)</b></p> <p><b>NOTE:</b> The BCM active command CHARGER must be sent before the BCM active command NEG MAIN is sent.</p> <ul style="list-style-type: none"> <li>• With key ON, enter BCM active command mode CONTACTOR OUTPUT CONTROL, monitor BCM PID LKRESB-, and set the active command CHARGER to CLOSE.</li> <li>• Set the active command NEG MAIN to OPEN.</li> <li>• Wait approximately 50 seconds.</li> <li>• <b>Does the LKRESB- PID indicate less than 50,000 ohms?</b></li> </ul>	<p>Yes = GO to <b>A33</b> (leakage is in contactor box or battery module voltage sense lines).</p> <p>No = GO to <b>A35</b>.</p>
<p><b>A33 CHECK FOR CURRENT LEAKAGE IN BATTERY MODULE VOLTAGE SENSE LINES</b></p>	

(Continued)

**DIAGNOSIS AND TESTING (Continued)****PINPOINT TEST A: DTC C1839 LEAKAGE FAULT**

TEST STEP	ACTION TO TAKE
<ul style="list-style-type: none"> <li>• With key ON, monitor BCM PID LEAK_ID and note the indicated battery module.</li> </ul> <p><b>NOTE:</b> If there is no continuity between the indicated battery module and chassis ground, check for continuity between chassis ground and the positive (+) posts of the two battery modules before and after the indicated battery module.</p> <ul style="list-style-type: none"> <li>• With key OFF, disconnect BCM C1865 and C1866, and check for continuity between the positive (+) post of the indicated battery module and chassis ground.</li> <li>• <b>Is there continuity?</b></li> </ul>	<p>Yes = REPLACE high-voltage harness (10B694) and/or the high-voltage harness (14A280) in question.</p> <p>No = GO to <b>A34</b>.</p>
<p><b>A34 CHECK FOR CURRENT LEAKAGE IN CONTACTOR BOX</b></p> <ul style="list-style-type: none"> <li>• With key OFF, disconnect the negative contactor box cable leading to the traction battery 250A high-voltage fuse.</li> </ul> <p><b>NOTE:</b> The BCM active command CHARGER must be sent before the BCM active command NEG MAIN is sent.</p> <ul style="list-style-type: none"> <li>• With key ON, enter BCM active command mode CONTACTOR OUTPUT CONTROL, monitor BCM PID LKRESB-, and set the active command CHARGER to CLOSE.</li> <li>• Set the active command NEG MAIN to OPEN.</li> <li>• Wait approximately 50 seconds.</li> <li>• <b>Does the LKRESB- PID indicate less than 50,000 ohms?</b></li> </ul>	<p>Yes = REPLACE the BCM.</p> <p>No = REPLACE the contactor box.</p>
<p><b>A35 CHECK FOR CURRENT LEAKAGE IN TRACTION BATTERY SUPPORT TRAY, TRACTION INVERTER MODULE (TIM), MOTOR/TRANSAXLE, OR IN THE AUXILIARY NEGATIVE BUS FOR THE HIGH-VOLTAGE AUXILIARY LOAD COMPONENTS</b></p> <ul style="list-style-type: none"> <li>• With key OFF, disconnect high-voltage auxiliary load in-line C1935 on the traction battery support tray.</li> </ul> <ul style="list-style-type: none"> <li>• With key ON, enter the TIM active command mode CONTACTOR OUTPUT CONTROL, monitor the BCM PID LKRESB-, and set the active command PRECHG IN to CLOSE.</li> <li>• Wait approximately 50 seconds.</li> <li>• <b>Does the LKRESB- PID indicate less than 50,000 ohms?</b></li> </ul>	<p>Yes = GO to <b>A36</b> (leakage is in contactor box, battery heater harness , TIM, or traction motor).</p> <p>No = GO to <b>A42</b> (leakage is in the auxiliary negative bus).</p>
<p><b>A36 CHECK FOR CURRENT LEAKAGE IN CONTACTOR BOX, BATTERY HEATER HARNESS (IF EQUIPPED), TIM, OR TRACTION MOTOR</b></p> <ul style="list-style-type: none"> <li>• With key OFF, disconnect the traction battery high-voltage two-pin C3994 and connect Traction Battery High-Voltage Lockout and Diagnostic Tool to the traction battery high-voltage two-pin C3994M.</li> <li>• With key ON, enter the TIM active command mode CONTACTOR OUTPUT CONTROL, monitor the BCM PID LKRESB-, and set the active command PRECHG IN to CLOSE.</li> <li>• Wait approximately 50 seconds.</li> <li>• <b>Does the LKRESB- PID indicate less than 50,000 ohms?</b></li> </ul>	<p>Yes = GO to <b>A39</b> (leakage is in battery heater harness or contactor box).</p> <p>No = GO to <b>A37</b> (leakage is in TIM or traction motor).</p>
<p><b>A37 CHECK FOR CURRENT LEAKAGE IN TIM OR TRACTION MOTOR</b></p> <ul style="list-style-type: none"> <li>• With key OFF, remove the Traction Battery High-Voltage Lockout and Diagnostic Tool, disconnect the traction motor three-phase cables from the TIM, and reconnect the traction battery high-voltage two-pin C3994.</li> </ul>	<p>Yes = GO to <b>A38</b> (leakage is in TIM or high-voltage cables to TIM).</p>

(Continued)

**DIAGNOSIS AND TESTING (Continued)****PINPOINT TEST A: DTC C1839 LEAKAGE FAULT**

<b>TEST STEP</b>	<b>ACTION TO TAKE</b>
<ul style="list-style-type: none"> <li>• With key ON, monitor BCM PIDs LKRESB+ and LKRESB-.</li> <li>• Wait approximately 50 seconds.</li> <li>• <b>Does the LKRESB+ or LKRESB- PID indicate less than 50,000 ohms?</b></li> </ul>	No = REPLACE the motor/transaxle. REFER to Section 303-01.
<b>A38 CHECK FOR CURRENT LEAKAGE IN TIM OR HIGH-VOLTAGE CABLES LEADING TO TIM</b> <ul style="list-style-type: none"> <li>• With key OFF, check the high-voltage cables to the TIM to see if the positive (+) or negative (-) cables are touching chassis ground.</li> <li>• <b>Are any of the cables touching chassis ground?</b></li> </ul>	Yes = REPLACE high-voltage harness (14B322). No = REPLACE the TIM. REFER to Section 303-14.
<b>A39 CHECK FOR CURRENT LEAKAGE IN CONTACTOR BOX OR BATTERY HEATER HARNESS (IF EQUIPPED)</b> <p>NOTE: If vehicle is not equipped with traction battery heaters, replace the contactor box.</p> <ul style="list-style-type: none"> <li>• Remove the traction battery and connect Traction Battery High-Voltage Lockout and Diagnostic Tool to the traction battery high-voltage two-pin C3994M.</li> <li>• Connect Traction Battery Low-Voltage Service Cord to traction battery support tray in-line C1939F and in-line C1939M.</li> </ul> <p> <b>WARNING: The traction battery contains high-voltage components and wiring. High-voltage insulated safety gloves and face shield must be worn when performing the following steps. Failure to follow this warning may result in severe personal injury or death.</b></p> <ul style="list-style-type: none"> <li>• Connect Auxiliary Interlock Tool to the high-voltage auxiliary load in-line C1935 on the traction battery support tray and in-line interlock C1948 (located behind the high voltage power distribution box ).</li> <li>• With key OFF, disconnect contactor box C1864.</li> <li>• With key ON, monitor BCM PIDs LKRESB+ and LKRESB-.</li> <li>• Wait approximately 50 seconds.</li> <li>• <b>Does the LKRESB+ or LKRESB- PID indicate less than 50,000 ohms?</b></li> </ul>	Yes = REPLACE the contactor box.  No = GO to A40 (leakage is in battery heater harness).
<b>A40 CHECK FOR CURRENT LEAKAGE IN LOWER BATTERY HEATER</b> <ul style="list-style-type: none"> <li>• With key OFF, reconnect contactor box C1864 and disconnect lower battery heater C1862 and C1863.</li> <li>• With key ON, monitor BCM PIDs LKRESB+ and LKRESB-.</li> <li>• Wait approximately 50 seconds.</li> <li>• <b>Does the LKRESB+ or LKRESB- PID indicate less than 50,000 ohms?</b></li> </ul>	Yes = GO to A41.  No = REPLACE the lower battery heater.
<b>A41 CHECK FOR CURRENT LEAKAGE IN UPPER BATTERY HEATER</b> <ul style="list-style-type: none"> <li>• With key OFF, disconnect upper battery heater C1859 and C1861.</li> <li>• With key ON, monitor BCM PIDs LKRESB+ and LKRESB-.</li> <li>• Wait approximately 50 seconds.</li> <li>• <b>Does the LKRESB+ or LKRESB- PID indicate less than 50,000 ohms?</b></li> </ul>	Yes = REPLACE high-voltage harness (10B700). No = REPLACE the upper battery heater.
<b>A42 CHECK FOR CURRENT LEAKAGE IN POWER STEERING ASSEMBLY</b> <ul style="list-style-type: none"> <li>• With key OFF, reconnect high-voltage auxiliary load in-line C1935 to the traction battery support tray.</li> </ul>	Yes = GO to A43.

(Continued)

**DIAGNOSIS AND TESTING (Continued)****PINPOINT TEST A: DTC C1839 LEAKAGE FAULT**

<b>TEST STEP</b>	<b>ACTION TO TAKE</b>
<ul style="list-style-type: none"> <li>• With key OFF, disconnect power steering assembly high-voltage C1895.</li> <li>• Connect Power Steering Interlock Tool to power steering assembly C1895.</li> <li>• With key ON, monitor BCM PID LKRESB-.</li> <li>• Wait approximately 50 seconds.</li> <li>• <b>Does the LKRESB- PID indicate less than 50,000 ohms?</b></li> </ul>	No = REPLACE the power steering assembly. REFER to Section 211-02.
<b>A43 CHECK FOR CURRENT LEAKAGE IN A/C COMPRESSOR</b> <ul style="list-style-type: none"> <li>• With key OFF, disconnect A/C inverter motor controller (IMC) high-voltage C1902 (to A/C compressor).</li> <li>• With key ON, monitor BCM PID LKRESB-.</li> <li>• Wait approximately 50 seconds.</li> <li>• <b>Does the LKRESB- PID indicate less than 50,000 ohms?</b></li> </ul>	Yes = GO to <b>A44</b> .  No = REPLACE the A/C compressor. REFER to Section 412-03.
<b>A44 CHECK FOR CURRENT LEAKAGE IN A/C IMC</b> <ul style="list-style-type: none"> <li>• With key OFF, remove the high voltage power distribution box (HVPDB) cover and disconnect HVPDB C1917 (to A/C IMC).</li> <li>• Reinstall the HVPDB cover.</li> <li>• With key ON, monitor BCM PID LKRESB-.</li> <li>• Wait approximately 50 seconds.</li> <li>• <b>Does the LKRESB- PID indicate less than 50,000 ohms?</b></li> </ul>	Yes = GO to <b>A45</b> .  No = REPLACE the A/C IMC. REFER to Section 412-03.
<b>A45 CHECK FOR CURRENT LEAKAGE IN POSITIVE TEMPERATURE COEFFICIENT (PTC) HEATER</b> <ul style="list-style-type: none"> <li>• With key OFF, disconnect PTC switching module high-voltage C1912.</li> <li>• With key ON, monitor BCM PID LKRESB-.</li> <li>• Wait approximately 50 seconds.</li> <li>• <b>Does the LKRESB- PID indicate less than 50,000 ohms?</b></li> </ul>	Yes = GO to <b>A46</b> . No = REPLACE the PTC heater. REFER to Section 412-02.
<b>A46 CHECK FOR CURRENT LEAKAGE IN PTC SWITCHING MODULE</b> <ul style="list-style-type: none"> <li>• With key OFF, remove the HVPDB cover and disconnect HVPDB C1920 (to PTC switching module).</li> <li>• Reinstall the HVPDB cover.</li> <li>• With key ON, monitor BCM PID LKRESB-.</li> <li>• Wait approximately 50 seconds.</li> <li>• <b>Does the LKRESB- PID indicate less than 50,000 ohms?</b></li> </ul>	Yes = GO to <b>A47</b> .  No = REPLACE the PTC switching module. REFER to Section 412-02.
<b>A47 CHECK FOR CURRENT LEAKAGE IN DC/DC CONVERTER</b> <ul style="list-style-type: none"> <li>• With key OFF, remove the HVPDB cover and disconnect HVPDB C1914 (to DC/DC converter).</li> <li>• Reinstall the HVPDB cover.</li> <li>• With key ON, monitor BCM PID LKRESB-.</li> <li>• Wait approximately 50 seconds.</li> <li>• <b>Does the LKRESB- PID indicate less than 50,000 ohms?</b></li> </ul>	Yes = GO to <b>A48</b> .  No = REPLACE the DC/DC converter. REFER to Section 414-02.
<b>A48 CHECK FOR CURRENT LEAKAGE IN TRACTION BATTERY CHARGER</b> <ul style="list-style-type: none"> <li>• With key OFF, remove the HVPDB cover and disconnect HVPDB C1923 (to traction battery charger).</li> <li>• Reinstall the HVPDB cover.</li> <li>• With key ON, monitor BCM PID LKRESB-.</li> <li>• Wait approximately 50 seconds.</li> <li>• <b>Does the LKRESB- PID indicate less than 50,000 ohms?</b></li> </ul>	Yes = REPLACE the HVPDB.  No = REPLACE the traction battery charger.
<b>A49 CHECK FOR CURRENT LEAKAGE IN HIGH-VOLTAGE POSITIVE BUS (TB+) (INSIDE TRACTION BATTERY SUPPORT TRAY)</b>	

(Continued)

**DIAGNOSIS AND TESTING (Continued)****PINPOINT TEST A: DTC C1839 LEAKAGE FAULT**

TEST STEP	ACTION TO TAKE
<p><b>NOTE:</b> The ignition key must be in the OFF position when performing this test step and you must wait approximately three minutes for the results.</p> <ul style="list-style-type: none"> <li>• With key OFF, monitor BCM PID LKRESB+.</li> <li>• Wait approximately three minutes.</li> <li>• <b>Does the LKRESB+ PID indicate less than 50,000 ohms?</b></li> </ul>	<p>Yes = GO to <b>A58</b> (leakage is in contactor box or battery module voltage sense lines).</p> <p>No = GO to <b>A50</b> (leakage is in auxiliary load + bus, TIM, or traction motor).</p>
<p><b>A50 CHECK FOR CURRENT LEAKAGE IN THE AUXILIARY POSITIVE (+) BUS (INSIDE TRACTION BATTERY SUPPORT TRAY) BETWEEN THE CONTACTOR BOX RELAYS AND TB+</b></p> <ul style="list-style-type: none"> <li>• With key OFF, disconnect high-voltage auxiliary load in-line C1935 on the traction battery support tray.</li> </ul> <p><b>NOTE:</b> The active command PRECHG IN must be sent before sending the active command POS MAIN. If not, New Generation STAR (NGS) Tester will indicate UNABLE TO PERFORM TEST/FUNCTION.</p> <ul style="list-style-type: none"> <li>• With key ON, enter TIM active command mode CONTACTOR OUTPUT CONTROL, monitor BCM PID LKRESB+, and set the active commands PRECHG IN to CLOSE and POS MAIN to CLOSE.</li> <li>• Wait approximately 50 seconds.</li> <li>• <b>Does the LKRESB+ PID indicate less than 50,000 ohms?</b></li> </ul>	<p>Yes = GO to <b>A51</b> (leakage is in TIM or traction motor)</p> <p>No = GO to <b>A53</b> (leakage is in auxiliary load + bus or traction battery charger + bus).</p>
<p><b>A51 CHECK FOR CURRENT LEAKAGE IN TIM OR TRACTION MOTOR</b></p> <ul style="list-style-type: none"> <li>• With key OFF, disconnect the traction battery high-voltage two-pin C3994 and the traction motor three-phase cables from the TIM, and reconnect the traction battery high-voltage two-pin C3994.</li> <li>• With key ON, enter TIM active command mode CONTACTOR OUTPUT CONTROL, monitor BCM PIDs LKRESB+ and LKRESB-, and set the active commands PRECHG IN to CLOSE and POS MAIN to CLOSE.</li> <li>• Wait approximately 50 seconds.</li> <li>• <b>Does the LKRESB+ or LKRESB- PID indicate less than 50,000 ohms?</b></li> </ul>	<p>Yes = GO to <b>A52</b> (leakage is in TIM or high-voltage cables leading to TIM).</p> <p>No = REPLACE the motor/transaxle. REFER to Section 303-01.</p>
<p><b>A52 CHECK FOR CURRENT LEAKAGE IN TIM OR HIGH-VOLTAGE CABLES LEADING TO TIM</b></p> <ul style="list-style-type: none"> <li>• With key OFF, check the high-voltage cable to the TIM to see if the positive (+) or negative (-) cables are touching chassis ground.</li> <li>• <b>Are any of the cables touching chassis ground?</b></li> </ul>	<p>Yes = REPLACE high-voltage harness (14B322).</p> <p>No = REPLACE the TIM. REFER to Section 303-14.</p>
<p><b>A53 CHECK FOR CURRENT LEAKAGE IN AUXILIARY LOAD POSITIVE (+) BUS OR TRACTION BATTERY CHARGER POSITIVE (+) BUS</b></p> <ul style="list-style-type: none"> <li>• With key OFF, disconnect the traction battery high-voltage two-pin C3994 and connect Traction Battery High-Voltage Lockout and Diagnostic Tool to the traction battery high-voltage two-pin C3994M.</li> <li>• With key OFF, reconnect high-voltage auxiliary load in-line C1935 to the traction battery support tray.</li> <li>• With key ON, monitor BCM PID LKRESB+.</li> <li>• Wait approximately 50 seconds.</li> <li>• <b>Does the LKRESB+ PID indicate less than 50,000 ohms?</b></li> </ul>	<p>Yes = GO to <b>A60</b> (leakage is in auxiliary load + bus).</p> <p>No = GO to <b>A54</b> (leakage is in traction battery charger + bus).</p>
<p><b>A54 CHECK FOR CURRENT LEAKAGE IN CONTACTOR BOX, BATTERY HEATER HARNESS (IF EQUIPPED), TRACTION BATTERY CHARGER, OR HVPDB</b></p>	

(Continued)



**DIAGNOSIS AND TESTING (Continued)****PINPOINT TEST A: DTC C1839 LEAKAGE FAULT**

<b>TEST STEP</b>	<b>ACTION TO TAKE</b>
<ul style="list-style-type: none"> <li>• With key OFF, disconnect high-voltage auxiliary load in-line C1935 on the traction battery support tray.</li> <li>• Connect Auxiliary Interlock Tool to the high-voltage auxiliary load in-line C1935 on the traction battery support tray and in-line interlock C1948 (located behind the HVPDB).</li> <li>• With key OFF, disconnect interface adapter assembly (IAA) module C1945.</li> <li>• With key ON, enter BCM active command mode CONTACTOR OUTPUT CONTROL, monitor BCM PID LKRESB+, and set the active command CHARGER to CLOSE.</li> <li>• Wait approximately 50 seconds.</li> <li>• <b>Does the LKRESB+ PID indicate less than 50,000 ohms?</b></li> </ul>	<p>Yes = GO to <b>A55</b> (leakage is in battery heater harness or contactor box).</p> <p>No = GO to <b>A59</b> (leakage is in traction battery charger or HVPDB).</p>
<p><b>A55 CHECK FOR CURRENT LEAKAGE IN CONTACTOR BOX OR BATTERY HEATER HARNESS (IF EQUIPPED)</b></p> <p><b>NOTE:</b> If vehicle is not equipped with traction battery heaters, replace the contactor box.</p> <ul style="list-style-type: none"> <li>• Remove the traction battery and connect Traction Battery High-Voltage Lockout and Diagnostic Tool to the traction battery high-voltage two-pin C3994M.</li> <li>• Connect Traction Battery Low-Voltage Service Cord to traction battery support tray in-line C1939F and in-line C1939M.</li> </ul> <p> <b>WARNING: The traction battery contains high-voltage components and wiring. High-voltage insulated safety gloves and face shield must be worn when performing the following steps. Failure to follow this warning may result in severe personal injury or death.</b></p> <ul style="list-style-type: none"> <li>• With key OFF, disconnect contactor box C1864.</li> <li>• Verify IAA module C1945 is still disconnected.</li> <li>• With key ON, monitor BCM PIDs LKRESB+ and LKRESB-.</li> <li>• Wait approximately 50 seconds.</li> <li>• <b>Does the LKRESB+ or LKRESB- PID indicate less than 50,000 ohms?</b></li> </ul>	<p>Yes = REPLACE the contactor box.</p> <p>No = GO to <b>A56</b> (leakage is in battery heater harness).</p>
<p><b>A56 CHECK FOR CURRENT LEAKAGE IN LOWER BATTERY HEATER</b></p> <ul style="list-style-type: none"> <li>• With key OFF, reconnect contactor box C1864 and disconnect lower battery heater C1862 and C1863.</li> <li>• With key ON, monitor BCM PIDs LKRESB+ and LKRESB-.</li> <li>• Wait approximately 50 seconds.</li> <li>• <b>Does the LKRESB+ or LKRESB- PID indicate less than 50,000 ohms?</b></li> </ul>	<p>Yes = GO to <b>A57</b>.</p> <p>No = REPLACE the lower battery heater.</p>
<p><b>A57 CHECK FOR CURRENT LEAKAGE IN UPPER BATTERY HEATER</b></p> <ul style="list-style-type: none"> <li>• With key OFF, disconnect upper battery heater C1859 and C1861.</li> <li>• With key ON, monitor BCM PIDs LKRESB+ and LKRESB-.</li> <li>• Wait approximately 50 seconds.</li> <li>• <b>Does the LKRESB+ or LKRESB- PID indicate less than 50,000 ohms?</b></li> </ul>	<p>Yes = REPLACE high-voltage harness (10B700).</p> <p>No = REPLACE the upper battery heater.</p>
<p><b>A58 CHECK FOR CURRENT LEAKAGE IN BATTERY MODULE VOLTAGE SENSE LINES</b></p>	

(Continued)

**DIAGNOSIS AND TESTING (Continued)****PINPOINT TEST A: DTC C1839 LEAKAGE FAULT**

TEST STEP	ACTION TO TAKE
<ul style="list-style-type: none"> <li>• With key ON, monitor BCM PID LEAK_ID and note the indicated battery module.</li> </ul> <p><b>NOTE:</b> If there is no continuity between the indicated battery module and chassis ground, check for continuity between chassis ground and the positive (+) posts of the two battery modules before and after the indicated battery module.</p> <ul style="list-style-type: none"> <li>• With key OFF, disconnect BCM C1865 and C1866, and check for continuity between the positive (+) post of the indicated battery module and chassis ground.</li> <li>• <b>Is there continuity?</b></li> </ul>	<p>Yes = REPLACE high-voltage harness (10B694) and/or the high-voltage harness (14A280) in question.</p> <p>No = REPLACE the contactor box.</p>
<p><b>A59 CHECK FOR CURRENT LEAKAGE IN TRACTION BATTERY CHARGER OR HVPDB</b></p> <ul style="list-style-type: none"> <li>• With key OFF, remove (if connected) Auxiliary Interlock Tool, and reconnect in-line interlock C1948 and high-voltage auxiliary load in-line C1935 to the traction battery support tray.</li> <li>• With key OFF, remove the high-voltage power distribution box (HVPDB) cover and disconnect HVPDB C1923 (to traction battery charger).</li> <li>• Reinstall the HVPDB cover.</li> <li>• With key ON, enter BCM active command mode CONTACTOR OUTPUT CONTROL, monitor BCM PID LKRESB+, and set the active command CHARGER to CLOSE.</li> <li>• Wait approximately 50 seconds.</li> <li>• <b>Does the LKRESB+ PID indicate less than 50,000 ohms?</b></li> </ul>	<p>Yes = REPLACE the HVPDB.</p> <p>No = REPLACE the traction battery charger.</p>
<p><b>A60 CHECK FOR CURRENT LEAKAGE IN AUXILIARY LOAD POSITIVE (+) BUS, CONTACTOR BOX, OR HVPDB</b></p> <ul style="list-style-type: none"> <li>• With key OFF, disconnect high-voltage auxiliary load in-line C1935 on the traction battery support tray.</li> <li>• Connect Auxiliary Interlock Tool to the high-voltage auxiliary load in-line C1935 on the traction battery support tray and in-line interlock C1948 (located behind the HVPDB).</li> <li>• With key ON, monitor BCM PID LKRESB+.</li> <li>• Wait approximately 50 seconds.</li> <li>• <b>Does the LKRESB+ PID indicate less than 50,000 ohms?</b></li> </ul>	<p>Yes = REPLACE the contactor box.</p> <p>No = GO to <b>A61</b> (leakage is in auxiliary load + bus or HVPDB).</p>
<p><b>A61 CHECK FOR CURRENT LEAKAGE IN POWER STEERING ASSEMBLY</b></p> <ul style="list-style-type: none"> <li>• With key OFF, remove Auxiliary Interlock Tool and reconnect in-line interlock C1948 and high-voltage auxiliary load in-line C1935 to the traction battery support tray.</li> <li>• With key OFF, disconnect power steering assembly high-voltage C1895.</li> <li>• Connect Power Steering Interlock Tool to power steering assembly C1895.</li> <li>• With key ON, monitor BCM PID LKRESB+.</li> <li>• Wait approximately 50 seconds.</li> <li>• <b>Does the LKRESB+ PID indicate less than 50,000 ohms?</b></li> </ul>	<p>Yes = GO to <b>A62</b>.</p> <p>No = REPLACE the power steering assembly. REFER to Section 211-02.</p>
<p><b>A62 CHECK FOR CURRENT LEAKAGE IN A/C COMPRESSOR</b></p> <ul style="list-style-type: none"> <li>• With key OFF, disconnect A/C inverter motor controller (IMC) high-voltage C1902 (to A/C compressor).</li> <li>• With key ON, monitor BCM PID LKRESB+.</li> <li>• Wait approximately 50 seconds.</li> <li>• <b>Does the LKRESB+ PID indicate less than 50,000 ohms?</b></li> </ul>	<p>Yes = GO to <b>A63</b>.</p> <p>No = REPLACE the A/C compressor. REFER to Section 412-03.</p>

(Continued)

**DIAGNOSIS AND TESTING (Continued)****PINPOINT TEST A: DTC C1839 LEAKAGE FAULT**

<b>TEST STEP</b>	<b>ACTION TO TAKE</b>
<b>A63 CHECK FOR CURRENT LEAKAGE IN A/C IMC</b> <ul style="list-style-type: none"> <li>With key OFF, remove the high-voltage power distribution box (HVPDB) cover and disconnect HVPDB C1917 (to A/C IMC).</li> <li>Reinstall the HVPDB cover.</li> <li>With key ON, monitor BCM PID LKRESB+.</li> <li>Wait approximately 50 seconds.</li> <li><b>Does the LKRESB+ PID indicate less than 50,000 ohms?</b></li> </ul>	Yes = GO to <b>A64</b> .  No = REPLACE the A/C IMC. REFER to Section 412-03.
<b>A64 CHECK FOR CURRENT LEAKAGE IN POSITIVE TEMPERATURE COEFFICIENT (PTC) HEATER</b> <ul style="list-style-type: none"> <li>With key OFF, disconnect PTC switching module high-voltage C1912.</li> <li>With key ON, monitor BCM PID LKRESB+.</li> <li>Wait approximately 50 seconds.</li> <li><b>Does the LKRESB+ PID indicate less than 50,000 ohms?</b></li> </ul>	Yes = GO to <b>A65</b> . No = REPLACE the PTC heater. REFER to Section 412-02.
<b>A65 CHECK FOR CURRENT LEAKAGE IN PTC SWITCHING MODULE</b> <ul style="list-style-type: none"> <li>With key OFF, remove the high-voltage power distribution box (HVPDB) cover and disconnect HVPDB C1920 (to PTC switching module).</li> <li>Reinstall the HVPDB cover.</li> <li>With key ON, monitor BCM PID LKRESB+.</li> <li>Wait approximately 50 seconds.</li> <li><b>Does the LKRESB+ PID indicate less than 50,000 ohms?</b></li> </ul>	Yes = GO to <b>A66</b> .  No = REPLACE the PTC switching module. REFER to Section 412-02.
<b>A66 CHECK FOR CURRENT LEAKAGE IN DC/DC CONVERTER</b> <ul style="list-style-type: none"> <li>With key OFF, remove the high-voltage power distribution box (HVPDB) cover and disconnect HVPDB C1914 (to DC/DC converter).</li> <li>Reinstall the HVPDB cover.</li> <li>With key ON, monitor BCM PID LKRESB+.</li> <li>Wait approximately 50 seconds.</li> <li><b>Does the LKRESB+ PID indicate less than 50,000 ohms?</b></li> </ul>	Yes = REPLACE the HVPDB.  No = REPLACE the DC/DC converter. REFER to Section 414-02.

**Regenerative Braking****Diagnostic Trouble Code (DTC) Definition**

The following DTCs relate to the regenerative braking system:

- DTC C1446 Brake Switch Circuit Failure
  - The brake pedal position (BPP) switch provides a 12-volt input signal to the traction inverter module (TIM) when the brake pedal is depressed. The TIM sets DTC C1446 if master cylinder brake pressure is detected without the brake pedal depressed. If this occurs, the TIM disables regenerative braking, and the malfunction indicator lamp (MIL) and red brake warning indicator illuminate.

- DTC C1849 Master Cylinder Pressure Out of Range
  - The traction inverter module (TIM) uses the input signal from the master cylinder brake pressure sensor to determine the amount of regenerative braking to be applied. The normal range of the master cylinder brake pressure sensor is between 0.5 and 4.5 volts. The TIM sets DTC C1849 if the signal is out of range. If this occurs, the TIM disables regenerative braking, and the malfunction indicator lamp (MIL) and red brake warning indicator illuminate.

**Electrical Schematic**

Refer to Electrical and Vacuum Troubleshooting Manual, Cell 26, Motor/Transaxle Control for schematic and connector information.

**Inspection and Verification**

Refer to [Section 100-07](#).

**DIAGNOSIS AND TESTING (Continued)****Symptom Chart****Symptom Chart**

Condition	Possible Sources	Action
<ul style="list-style-type: none"> <li>DTC C1446 Brake Switch Circuit Failure</li> </ul>	<ul style="list-style-type: none"> <li>Fuse.</li> <li>Circuit(s).</li> <li>Traction inverter module (TIM).</li> <li>Brake pedal position (BPP) switch.</li> <li>Master cylinder brake pressure sensor.</li> </ul>	<ul style="list-style-type: none"> <li>GO to Pinpoint Test A.</li> </ul>
<ul style="list-style-type: none"> <li>DTC C1849 Master Cylinder Pressure Out of Range</li> </ul>	<ul style="list-style-type: none"> <li>Circuit(s).</li> <li>Master cylinder brake pressure sensor.</li> <li>Traction inverter module (TIM).</li> </ul>	<ul style="list-style-type: none"> <li>GO to Pinpoint Test B.</li> </ul>

**Pinpoint Tests****Special Tool(s)**

104-Pin Breakout Box (BOB) 418-049 (014-00950) or equivalent
BCM/TIM Breakout Box (BOB) Adapter Cable 418-F212
BCM/TIM Breakout Box (BOB) Overlay 418-F220

**PINPOINT TEST A: DTC C1446 BRAKE SWITCH CIRCUIT FAILURE**

TEST STEP	ACTION TO TAKE
<b>A1 CHECK BRAKE SWITCH STATUS</b> <ul style="list-style-type: none"> <li>With key ON, monitor the traction inverter module (TIM) PID BOO__TIM while depressing the brake pedal.</li> <li><b>Does the BOO__TIM PID indicate OFF with the brake pedal not depressed and ON with the brake pedal depressed?</b></li> </ul>	Yes = GO to A5. No = GO to A2.
<b>A2 CHECK FUSE AND POWER TO BRAKE PEDAL POSITION (BPP) SWITCH</b> <ul style="list-style-type: none"> <li>With key OFF, check 10A fuse 13 in the I/P fuse panel.</li> <li>With key OFF, disconnect BPP switch C210 and measure the voltage between pin 3 (LG/R wire) on BPP switch C210 and ground. (V &gt; 10 volts)</li> <li><b>Is everything OK?</b></li> </ul>	Yes = RECONNECT the BPP switch. GO to A3. No = REPAIR as necessary.
<b>A3 CHECK BPP SWITCH SIGNAL TO TIM</b> <ul style="list-style-type: none"> <li>Connect 104-Pin Breakout Box (BOB) to TIM C4998, C4999 using the BCM/TIM BOB Adapter Cable and Overlay; leave the TIM disconnected.</li> <li>With key ON, measure the voltage between BOB pin B14 and ground (BOB pin A29) with the brake pedal depressed.</li> <li><b>Is the voltage greater than 10 volts?</b></li> </ul>	Yes = REPLACE the TIM. REFER to Section 303-14. No = GO to A4.
<b>A4 CHECK CIRCUIT 810 (R/LG) FOR OPEN</b> <ul style="list-style-type: none"> <li>With key OFF, disconnect BPP switch C210 and measure the resistance of the R/LG wire between pin 4 on BPP switch C210 and BOB pin 14.</li> <li><b>Is the resistance less than 5 ohms?</b></li> </ul>	Yes = REPLACE the BPP switch. No = REPAIR the R/LG wire.

(Continued)

**DIAGNOSIS AND TESTING (Continued)****PINPOINT TEST A: DTC C1446 BRAKE SWITCH CIRCUIT FAILURE**

TEST STEP	ACTION TO TAKE
<b>A5 CHECK MASTER CYLINDER PRESSURE STATUS</b> <ul style="list-style-type: none"> <li>• With key ON, monitor the TIM PID MC__PRES while depressing the brake pedal.</li> <li>• <b>Does the MC__PRES PID increase from approximately 0.45 to 4.65 volts as the brake pedal is depressed?</b></li> </ul>	Yes = System OK. CHECK wiring for intermittent connections. No = If MC__PRES decreases from approximately 4.60 to 4.10 volts, GO to <b>A6</b> . If MC__PRES is greater than 4.8 volts at all times, GO to <b>A8</b> .
<b>A6 CHECK MASTER CYLINDER BRAKE PRESSURE SENSOR GROUND REFERENCE CIRCUIT</b> <ul style="list-style-type: none"> <li>• With key OFF, disconnect master cylinder brake pressure sensor C1940 and measure the resistance between the W/R wire on master cylinder brake pressure sensor C1940 and ground.</li> <li>• <b>Is the resistance less than 5 ohms?</b></li> </ul>	Yes = REPLACE the master cylinder brake pressure sensor. No = GO to <b>A7</b> .
<b>A7 CHECK CIRCUIT 3601 (W/R) FOR OPEN</b> <ul style="list-style-type: none"> <li>• Connect 104-Pin Breakout Box (BOB) to TIM C4998, C4999 using the BCM/TIM BOB Adapter Cable and Overlay; leave the TIM disconnected.</li> <li>• With key OFF, measure the resistance of the W/R wire between master cylinder brake pressure sensor C1940 and BOB pin B21.</li> <li>• <b>Is the resistance less than 5 ohms?</b></li> </ul>	Yes = REPLACE the TIM. REFER to Section 303-14. No = REPAIR the W/R wire.
<b>A8 CHECK CIRCUIT 3600 (R/W) FOR SHORT TO POWER</b> <ul style="list-style-type: none"> <li>• Connect 104-Pin Breakout Box (BOB) to TIM C4998, C4999 using the BCM/TIM BOB Adapter Cable and Overlay; leave the TIM disconnected.</li> <li>• With key OFF, disconnect master cylinder brake pressure sensor C1940.</li> <li>• With key ON, measure the voltage between BOB pin B22 and ground (BOB pin A29).</li> <li>• <b>Is the voltage greater than 0 volts?</b></li> </ul>	Yes = REPAIR the R/W wire. No = REPLACE the TIM. REFER to Section 303-14.

**PINPOINT TEST B: DTC C1849 MASTER CYLINDER PRESSURE OUT OF RANGE**

TEST STEP	ACTION TO TAKE
<b>B1 CHECK MASTER CYLINDER PRESSURE STATUS</b> <ul style="list-style-type: none"> <li>• With key ON, monitor the traction inverter module (TIM) PID MC__PRES while depressing the brake pedal.</li> <li>• <b>Does the MC__PRES PID voltage increase from approximately 0.45 to 4.65 volts as the brake pedal is depressed?</b></li> </ul>	Yes = System OK. CHECK wiring for intermittent connections. No = If MC__PRES is between 0.8 and 0.15 volts at all times, GO to <b>B2</b> . If MC__PRES is 0.0 volts at all times, GO to <b>B4</b> .
<b>B2 CHECK CIRCUIT 3600 (R/W) FOR OPEN</b> <ul style="list-style-type: none"> <li>• Connect 104-Pin Breakout Box (BOB) to TIM C4998, C4999 using the BCM/TIM BOB Adapter Cable and Overlay; leave the TIM disconnected.</li> <li>• With key OFF, disconnect master cylinder brake pressure sensor C1940 and measure the resistance of the R/W wire between master cylinder brake pressure sensor C1940 and BOB pin B22.</li> <li>• <b>Is the resistance less than 5 ohms?</b></li> </ul>	Yes = GO to <b>B3</b> . No = REPAIR the R/W wire.
<b>B3 CHECK CIRCUIT 3600 (R/W) FOR SHORT TO GROUND</b>	

(Continued)

**DIAGNOSIS AND TESTING (Continued)****PINPOINT TEST B: DTC C1849 MASTER CYLINDER PRESSURE OUT OF RANGE**

TEST STEP	ACTION TO TAKE
<ul style="list-style-type: none"> <li>With key ON, measure the resistance between BOB pin B22 and ground (BOB pin A29).</li> <li><b>Is the resistance greater than 10,000 ohms?</b></li> </ul>	Yes = REPLACE the master cylinder brake pressure sensor. No = REPAIR the R/W wire.
<b>B4 CHECK TIM VOLTAGE REFERENCE TO MASTER CYLINDER BRAKE PRESSURE SENSOR</b> <ul style="list-style-type: none"> <li>With key OFF, disconnect master cylinder brake pressure sensor C1940.</li> <li>With key ON, measure the voltage between the R wire on master cylinder brake pressure sensor C1940 and ground.</li> <li><b>Is the voltage greater than 4.8 volts?</b></li> </ul>	Yes = REPLACE the master cylinder brake pressure sensor. No = GO to <b>B5</b> .
<b>B5 CHECK CIRCUIT 3603 (R) FOR OPEN</b> <ul style="list-style-type: none"> <li>Connect 104-Pin Breakout Box (BOB) to TIM C4998, C4999 using the BCM/TIM BOB Adapter Cable and Overlay; leave the TIM disconnected.</li> <li>With key OFF, measure the resistance of the R wire between master cylinder brake pressure sensor C1940 and BOB pin B23.</li> <li><b>Is the resistance less than 5 ohms?</b></li> </ul>	Yes = GO to <b>B6</b> . No = REPAIR the R wire.
<b>B6 CHECK CIRCUIT 3603 (R) FOR SHORT TO GROUND</b> <ul style="list-style-type: none"> <li>With key OFF, measure the resistance between BOB pin B23 and ground (BOB pin A29).</li> <li><b>Is the resistance greater than 10,000 ohms?</b></li> </ul>	Yes = REPLACE the TIM. REFER to Section 303-14. No = REPAIR the R wire.

**Traction Battery Charging/Heating System****Diagnostic Trouble Code (DTC) Definition**

The following DTCs relate to the traction battery charging/heating system:

- DTC C1836 Battery Temperature Out of Range
  - The battery control module (BCM) uses four temperature sensors to monitor the temperature of the traction battery. The normal range of the temperature sensors is between 240 and 205,000 ohms. The BCM sets DTC C1836 if it detects any of the temperature sensor readings out of range. The BCM uses PIDs to indicate the temperature sensor that is out of range.
- DTC C1837 Battery Heater Circuit Failure
  - The battery control module (BCM) checks for a traction battery heater failure during current charge mode and when the BCM on-demand self-test is performed. The BCM actuates each heater and checks for an increase in current coming from the battery as a result of the heater being turned on. If there is no increase in current after several attempts, the BCM sets DTC C1837. The BCM uses PIDs to indicate the heater that has failed.

## DIAGNOSIS AND TESTING (Continued)

- DTC C1838 Charging System Fault
  - The battery control module (BCM) sets DTC C1838 when a failure occurs in the traction battery charging system. The BCM uses PIDs to indicate the charging system failure that occurred. The possible failures are:
    - A charger charging after being disabled fault occurs if the charger charging signal or the auxiliary current sensor indicates that the charger is still outputting significant current several seconds after the BCM has commanded the charger off.
    - A charger overtemperature fault occurs if the charger fault signal is asserted and the charger ready signal is deasserted during a charge cycle.
    - A charger latchup fault occurs if the charger fault signal and charger ready signal are asserted during a charge cycle.
    - A charger cycling fault occurs if the charger is cycled on and off several times within a short period of time due to a reoccurring fault condition. If this occurs, the BCM disables the charger.
    - A charger undercurrent fault occurs if the BCM commands maximum power output from the charger and little or no current is detected at the auxiliary current sensor for an extended period of time. There are several potential causes for this fault.
    - A charger overcurrent fault occurs if the BCM commands zero power output from the charger and significant current is detected at the auxiliary current sensor for an extended period of time.
    - A charger overvoltage fault occurs if the BCM detects the traction battery voltage to be greater than 425 volts during a charge cycle. If this occurs, the BCM disables the charger.
    - A charger over amp-hours fault occurs the BCM detects that more than 110 amp-hours of current have been put into the traction battery during the charge cycle. If this occurs, the BCM disables the charger.
    - A charger line capacity fault occurs if the BCM commands maximum power output from the charger and little or no current is detected at the auxiliary current sensor for an extended period of time and the charger line capacity signal indicates zero.
  - A charger mode fault occurs if the BCM detects the charger mode signal is not being pulled up to auxiliary battery voltage by the charger. If this occurs, the BCM does not enable the charger.
- DTC C1859 PRNDL Input #2 Circuit Failure
  - The battery control module (BCM) sets DTC C1859 during the BCM on-demand self test if it detects the PRNDE TR2 signal is not grounded. An open or short in the TR2 signal wire or the gear selector not in the PARK position during the on-demand self-test will cause DTC C1859.
- DTC C1861 PRNDL Input #4 Circuit Failure
  - The battery control module (BCM) sets DTC C1861 during the BCM on-demand self test if it detects the PRNDE TR4 signal is not grounded. An open or short in the TR4 signal wire or the gear selector not in the PARK position during the on-demand self-test will cause DTC C1861.
- DTC C1863 External Charging Fault
  - The battery control module (BCM) sets DTC C1863 if the on-plug circuit indicates the vehicle is plugged into a power control station (PCS) and the traction inverter module (TIM) indicates the vehicle is traveling faster than 15 km/h (9.4 mph).
- DTC B2247 Electric Vehicle Battery Pack Temperature Fault
  - The battery control module (BCM) uses four temperature sensors to monitor the temperature of the traction battery. The BCM sets DTC B2247 if it detects a change in temperature (Tmax-Tmin) greater than 15°C (59°F) between any of the temperature sensors in the battery pack or if it detects any of the temperature sensors at a temperature greater than or equal to 83°C (181°F). If Tmax (maximum temperature of any of the four battery temperature sensors) is greater than or equal to 83°C (181°F), the BCM will turn off the traction battery cooling/ventilation fan to prevent oxygen from entering the traction battery. The BCM will prevent charging if the temperature difference between any of the temperature sensors is greater than 30°C (86°F).

**DIAGNOSIS AND TESTING (Continued)****Electrical Schematic**

Refer to Electrical and Vacuum Troubleshooting Manual, Cell 18, Traction Battery Charging/Heating System for schematic and connector information.

**Inspection and Verification**

Refer to [Section 100-07](#).

**Symptom Chart****Symptom Chart**

<b>Condition</b>	<b>Possible Sources</b>	<b>Action</b>
<ul style="list-style-type: none"> <li>DTC C1836 Battery Temperature Out of Range</li> </ul>	<ul style="list-style-type: none"> <li>Circuit(s).</li> <li>Battery temperature sensor.</li> <li>Battery control module (BCM).</li> </ul>	<ul style="list-style-type: none"> <li>GO to Pinpoint Test A.</li> </ul>
<ul style="list-style-type: none"> <li>DTC C1837 Battery Heater Circuit Failure</li> </ul>	<ul style="list-style-type: none"> <li>Charging system fault.</li> <li>Circuit(s).</li> <li>High-voltage harness 10B700.</li> <li>Contactor box high-voltage fuse.</li> <li>Contactor box.</li> <li>Battery control module (BCM).</li> <li>Upper battery module heater(s).</li> <li>Lower battery heater.</li> </ul>	<ul style="list-style-type: none"> <li>GO to Pinpoint Test B.</li> </ul>
<ul style="list-style-type: none"> <li>DTC C1838 Charging System Fault</li> </ul>	<ul style="list-style-type: none"> <li>Charger charging fault.</li> <li>Charger over-temperature fault.</li> <li>Charger latchup fault.</li> <li>Charger cycling fault.</li> <li>Charger under current fault.</li> <li>Charger over current fault.</li> <li>Charger over voltage fault.</li> <li>Charger over amp-hours fault.</li> <li>Charger line capacity fault.</li> <li>Charger mode feedback fault.</li> </ul>	<ul style="list-style-type: none"> <li>GO to Pinpoint Test C.</li> </ul>
<ul style="list-style-type: none"> <li>Charger Charging After Being Disabled Fault</li> </ul>	<ul style="list-style-type: none"> <li>Contactor box.</li> <li>Circuit(s).</li> <li>Traction battery charger.</li> <li>Battery control module (BCM).</li> </ul>	<ul style="list-style-type: none"> <li>GO to Pinpoint Test D.</li> </ul>
<ul style="list-style-type: none"> <li>Charger Over-Temperature Fault</li> </ul>	<ul style="list-style-type: none"> <li>Circuit(s).</li> <li>Traction battery charger.</li> <li>Battery control module (BCM).</li> </ul>	<ul style="list-style-type: none"> <li>GO to Pinpoint Test E.</li> </ul>
<ul style="list-style-type: none"> <li>Charger Latchup Fault</li> </ul>	<ul style="list-style-type: none"> <li>Circuit(s).</li> <li>Traction battery charger.</li> <li>Battery control module (BCM).</li> </ul>	<ul style="list-style-type: none"> <li>GO to Pinpoint Test F.</li> </ul>
<ul style="list-style-type: none"> <li>Charger Cycling Fault</li> </ul>	<ul style="list-style-type: none"> <li>Current leakage condition.</li> <li>Traction battery charger.</li> </ul>	<ul style="list-style-type: none"> <li>GO to Pinpoint Test G.</li> </ul>



**DIAGNOSIS AND TESTING (Continued)****Symptom Chart (Continued)**

<b>Condition</b>	<b>Possible Sources</b>	<b>Action</b>
<ul style="list-style-type: none"> <li>Charger Under Current Fault</li> </ul>	<ul style="list-style-type: none"> <li>High voltage power distribution box (HVPDB).</li> <li>High-voltage harness (14B326).</li> <li>Contactor box high-voltage fuse.</li> <li>Contactor box.</li> <li>Battery control module (BCM).</li> <li>Circuit(s).</li> <li>Traction battery charger.</li> </ul>	<ul style="list-style-type: none"> <li>GO to Pinpoint Test H.</li> </ul>
<ul style="list-style-type: none"> <li>Charger Over Current Fault</li> </ul>	<ul style="list-style-type: none"> <li>Traction battery charger.</li> <li>Contactor box.</li> <li>Battery control module (BCM).</li> </ul>	<ul style="list-style-type: none"> <li>GO to Pinpoint Test J.</li> </ul>
<ul style="list-style-type: none"> <li>Charger Over Voltage Fault</li> </ul>	<ul style="list-style-type: none"> <li>High-voltage harness (14A280-WD).</li> <li>High-voltage harness (14A280-RF).</li> <li>Battery control module (BCM).</li> </ul>	<ul style="list-style-type: none"> <li>GO to Pinpoint Test K.</li> </ul>
<ul style="list-style-type: none"> <li>Charger Line Capacity Fault</li> </ul>	<ul style="list-style-type: none"> <li>Power control station (PCS).</li> <li>Traction battery charger.</li> </ul>	<ul style="list-style-type: none"> <li>GO to Pinpoint Test M.</li> </ul>
<ul style="list-style-type: none"> <li>Charger Mode Feedback Fault</li> </ul>	<ul style="list-style-type: none"> <li>Circuit(s).</li> <li>Traction battery charger.</li> <li>Battery control module (BCM).</li> </ul>	<ul style="list-style-type: none"> <li>GO to Pinpoint Test N.</li> </ul>
<ul style="list-style-type: none"> <li>DTC C1859 PRNDL Input #2 Circuit Failure</li> </ul>	<ul style="list-style-type: none"> <li>Circuit(s).</li> <li>Battery control module (BCM).</li> </ul>	<ul style="list-style-type: none"> <li>GO to Pinpoint Test P.</li> </ul>
<ul style="list-style-type: none"> <li>DTC C1861 PRNDL Input #4 Circuit Failure</li> </ul>	<ul style="list-style-type: none"> <li>Circuit(s).</li> <li>Battery control module (BCM).</li> </ul>	<ul style="list-style-type: none"> <li>GO to Pinpoint Test Q.</li> </ul>
<ul style="list-style-type: none"> <li>DTC C1863 External Charging Fault</li> </ul>	<ul style="list-style-type: none"> <li>Circuit(s).</li> <li>Charger inlet assembly.</li> <li>Battery control module (BCM).</li> </ul>	<ul style="list-style-type: none"> <li>GO to Pinpoint Test R.</li> </ul>
<ul style="list-style-type: none"> <li>DTC B2247 Electric Vehicle Battery Pack Temperature Fault</li> </ul>	<ul style="list-style-type: none"> <li>Battery pack overtemperature condition.</li> </ul>	<ul style="list-style-type: none"> <li>GO to Pinpoint Test S.</li> </ul>
<ul style="list-style-type: none"> <li>Power Control Station (PCS) Operation Verification Test</li> </ul>	<ul style="list-style-type: none"> <li>Improper PCS connection to charger inlet.</li> <li>PCS.</li> <li>Vehicle charging system failure.</li> </ul>	<ul style="list-style-type: none"> <li>GO to Pinpoint Test T.</li> </ul>

**Pinpoint Tests****Special Tool(s)**

104-Pin Breakout Box (BOB) 418-049 (014-00950) or equivalent
--

BCM/TIM Breakout Box (BOB) Adapter Cable 418-F212
---

(Continued)

**Special Tool(s)**

BCM/TIM Breakout Box (BOB) Overlay 418-F220
---

Traction Battery High-Voltage Service Cord 418-F218
---

Traction Battery Low-Voltage Service Cord 418-F219
--

(Continued)

**DIAGNOSIS AND TESTING (Continued)****Special Tool(s)**

Traction Battery High-Voltage Lockout and Diagnostic Tool 418-F207
--

High-Voltage Insulated Safety Gloves 100-F036 or equivalent
---

Face Shield 100-F035 or equivalent
------------------------------------

**PINPOINT TEST A: DTC C1836 BATTERY TEMPERATURE OUT OF RANGE**

TEST STEP	ACTION TO TAKE
<b>A1 CHECK FOR BATTERY TEMPERATURE SENSOR OUT OF RANGE FAULT</b> <ul style="list-style-type: none"> <li>With key ON, monitor battery control module (BCM) PIDs BATTMP1, BATTMP2, BATTMP3, and BATTMP4.</li> <li>Do any of the BATTMP PIDs indicate YES?</li> </ul>	Yes = GO to <b>A2</b> .  No = System OK. If DTC C1836 reoccurs intermittently, GO to <b>A6</b> .
<b>A2 CHECK WIRES TO BATTERY TEMPERATURE SENSOR FOR OPEN(S)</b> <ul style="list-style-type: none"> <li>Remove the traction battery and connect Traction Battery High-Voltage Lockout and Diagnostic Tool to the traction battery high-voltage two-pin C3994M.</li> </ul> <p><b>⚠ WARNING: The traction battery contains high-voltage components and wiring. High-voltage insulated safety gloves and face shield must be worn when performing the following steps. Failure to follow this warning may result in severe personal injury or death.</b></p> <ul style="list-style-type: none"> <li>Connect 104-Pin Breakout Box (BOB) to BCM C1986, C1987 using the BCM/TIM BOB Adapter Cable and Overlay; leave the BCM disconnected.</li> <li>Measure the resistance of the wires indicated below for the battery temperature sensor in question.</li> </ul> <p><b>Battery Temperature Sensor #1:</b></p> <ul style="list-style-type: none"> <li>With key OFF, disconnect upper front pack temperature sensor #1 C1988 and measure the resistance of the BR wire between BOB pin A40 and temperature sensor #1 C1988.</li> <li>With key OFF, measure the resistance of the BR/W wire between BOB pin A9 and temperature sensor #1 C1988.</li> </ul> <p><b>Battery Temperature Sensor #2:</b></p> <ul style="list-style-type: none"> <li>With key OFF, disconnect rear upper pack temperature sensor #2 C1989 and measure the resistance of the GY/BK wire between BOB pin A21 and temperature sensor #2 C1989.</li> <li>With key OFF, measure the resistance of the DG wire between BOB pin A22 and temperature sensor #2 C1989.</li> </ul> <p><b>Battery Temperature Sensor #3:</b></p> <ul style="list-style-type: none"> <li>With key OFF, disconnect lower front pack temperature sensor #3 C1981 and measure the resistance of the LG/BK wire between BOB pin A24 and temperature sensor #3 C1981.</li> <li>With key OFF, measure the resistance of the R/W wire between BOB pin A25 and temperature sensor #3 C1981.</li> </ul> <p><b>Battery Temperature Sensor #4:</b></p>	Yes = GO to <b>A3</b> .  No = REPAIR the wire(s) in question.

(Continued)

**DIAGNOSIS AND TESTING (Continued)****PINPOINT TEST A: DTC C1836 BATTERY TEMPERATURE OUT OF RANGE**

TEST STEP	ACTION TO TAKE
<ul style="list-style-type: none"> <li>• With key OFF, disconnect lower rear pack temperature sensor #4 C1985 and measure the resistance of the BK/LB wire between BOB pin A26 and temperature sensor #4 C1985.</li> <li>• With key OFF, measure the resistance of the DG/W wire between BOB pin A27 and temperature sensor #4 C1985.</li> <li>• <b>Are the resistances less than 5 ohms?</b></li> </ul>	
<p><b>A3 CHECK SIGNAL WIRE TO BATTERY TEMPERATURE SENSOR FOR SHORT TO GROUND</b></p> <ul style="list-style-type: none"> <li>• With key OFF, measure the resistance between the BOB pins indicated below for the battery temperature sensor in question.</li> </ul> <p><b>Battery Temperature Sensor #1</b> —BOB pins A9 and A33</p> <p><b>Battery Temperature Sensor #2</b> —BOB pins A22 and A33</p> <p><b>Battery Temperature Sensor #3</b> —BOB pins A25 and A33</p> <p><b>Battery Temperature Sensor #4</b> —BOB pins A27 and A33</p> <ul style="list-style-type: none"> <li>• <b>Is the resistance greater than 10,000 ohms?</b></li> </ul>	<p>Yes = GO to A4.</p> <p>No = REPAIR the BR/W wire (#1), DG wire (#2), R/W wire (#3), or DG/W wire (#4).</p>
<p><b>A4 CHECK SIGNAL WIRE TO BATTERY TEMPERATURE SENSOR FOR SHORT TO POWER</b></p> <ul style="list-style-type: none"> <li>• Connect Traction Battery Low-Voltage Service Cord to traction battery support tray in-line C1939F and in-line C1939M.</li> <li>• With key OFF, disconnect high-voltage auxiliary load in-line C1935 from the traction battery support tray and connect Traction Battery High-Voltage Service Cord to traction battery support tray in-line C1935F and in-line C1935M.</li> <li>• With key ON, measure the voltage between the BOB pins indicated below for the battery temperature sensor in question.</li> </ul> <p><b>Battery Temperature Sensor #1</b> —BOB pins A9 and A33</p> <p><b>Battery Temperature Sensor #2</b> —BOB pins A22 and A33</p> <p><b>Battery Temperature Sensor #3</b> —BOB pins A25 and A33</p> <p><b>Battery Temperature Sensor #4</b> —BOB pins A27 and A33</p> <ul style="list-style-type: none"> <li>• <b>Is the voltage greater than 0 volts?</b></li> </ul>	<p>Yes = REPAIR the BR/W wire (#1), DG wire (#2), R/W wire (#3), or DG/W wire (#4).</p> <p>No = GO to A5.</p>
<p><b>A5 CHECK BATTERY TEMPERATURE SENSOR</b></p> <ul style="list-style-type: none"> <li>• With key OFF, measure the resistance between the terminals of the battery temperature sensor in question.</li> <li>• <b>Is the resistance between 240 and 205,000 ohms?</b></li> </ul>	<p>Yes = REPLACE the BCM.</p> <p>No = REPLACE the battery temperature sensor.</p>
<p><b>A6 CHECK WIRING FOR INTERMITTENT CONNECTIONS</b></p> <ul style="list-style-type: none"> <li>• Remove the traction battery and connect Traction Battery High-Voltage Lockout and Diagnostic Tool to the traction battery high-voltage two-pin C3994M.</li> </ul>	<p>Yes = REPAIR the wire(s) for intermittent connections.</p>

(Continued)

**DIAGNOSIS AND TESTING (Continued)****PINPOINT TEST A: DTC C1836 BATTERY TEMPERATURE OUT OF RANGE**

TEST STEP	ACTION TO TAKE
<ul style="list-style-type: none"> <li>• Connect Traction Battery Low-Voltage Service Cord to traction battery support tray in-line C1939F and in-line C1939M.</li> <li>• Connect Traction Battery High-Voltage Service Cord to traction battery support tray in-line C1935F and in-line C1935M.</li> <li>• Clear the BCM DTCs.</li> <li>• With key ON, monitor BCM PID BATTMP for the battery temperature sensor in question.</li> <li>• Exercise (wiggle) the wiring harness to the battery temperature sensor.</li> <li>• <b>Does the BATTMP PID indicate YES?</b></li> </ul>	No = System OK. If DTC C1836 keeps occurring, REPLACE the BCM.

**PINPOINT TEST B: DTC C1837 BATTERY HEATER CIRCUIT FAILURE**

TEST STEP	ACTION TO TAKE
<p><b>B1 CHECK FOR CHARGING SYSTEM FAULT</b></p> <p><b>NOTE:</b> Clear the diagnostic trouble codes (DTCs) from the battery control module (BCM) continuous memory before connecting the vehicle to a power control station (PCS). The vehicle may need to be left on charge for up to five minutes to set a charging system fault (DTC C1838).</p> <ul style="list-style-type: none"> <li>• Connect the vehicle to the PCS and press the START button to begin charging.</li> <li>• Wait approximately five minutes and retrieve continuous DTCs from the BCM.</li> <li>• <b>Does DTC C1838 Charging System Fault occur?</b></li> </ul>	Yes = REFER to Symptom Chart.  No = DISCONNECT PCS from vehicle. GO to <b>B2</b> .
<p><b>B2 CHECK STATUS OF AUXILIARY CURRENT</b></p> <p><b>NOTE:</b> The amperage for the AUX__CNT PID should increase by more than 0.8 amps when each battery heater is enabled.</p> <ul style="list-style-type: none"> <li>• Enter BCM active command mode BCM PACKETED COMMAND, monitor BCM PID AUX__CNT, and set the active commands below in the indicated order:               <ol style="list-style-type: none"> <li>1. Set CHARGER C to CLOSE.</li> <li>2. Set CURRENT S to ENABLE.</li> <li>3. Set BAT HTR 1 to ENABLE.</li> <li>4. Set BAT HTR 2 to ENABLE.</li> </ol> </li> <li>• <b>Does the amperage for the AUX__CNT PID stay the same when BAT HTR 1 and BAT HTR 2 are enabled?</b></li> </ul>	Yes = GO to <b>B3</b> .  No = If the amperage increases for BAT HTR 2, but not for BAT HTR 1, GO to <b>B5</b> . If the amperage increases for BAT HTR 1, but not for BAT HTR 2, GO to <b>B10</b> .
<p><b>B3 CHECK CIRCUIT 57 (BK) TO BATTERY HEATERS FOR OPEN</b></p> <ul style="list-style-type: none"> <li>• Remove the traction battery and connect Traction Battery High-Voltage Lockout and Diagnostic Tool to the traction battery high-voltage two-pin C3994M.</li> </ul> <p> <b>WARNING: The traction battery contains high-voltage components and wiring. High-voltage insulated safety gloves and face shield must be worn when performing the following steps. Failure to follow this warning may result in severe personal injury or death.</b></p> <ul style="list-style-type: none"> <li>• Disconnect contactor box C1864 and measure the resistance between pin B (BK wire) and pin C (R wire) on contactor box C1864.</li> <li>• <b>Is the resistance between 330 and 390 ohms?</b></li> </ul>	Yes = GO to <b>B4</b> .  No = REPLACE high-voltage harness (10B700).

(Continued)

**DIAGNOSIS AND TESTING (Continued)****PINPOINT TEST B: DTC C1837 BATTERY HEATER CIRCUIT FAILURE**

TEST STEP	ACTION TO TAKE
<b>B4 CHECK CONTACTOR BOX HIGH-VOLTAGE FUSE</b> <ul style="list-style-type: none"> <li>Remove the 10A HTR fuse from the contactor box. Refer to the Contactor Box Fuses Removal and Installation procedure in this section.</li> <li>Measure the resistance of the 10A HTR fuse.</li> <li><b>Is the resistance greater than 1,000 ohms?</b></li> </ul>	Yes = REPLACE the 10A HTR fuse. No = REPLACE the contactor box.
<b>B5 CHECK UPPER BATTERY HEATERS FOR OPEN</b> <ul style="list-style-type: none"> <li>Remove the traction battery and connect Traction Battery High-Voltage Lockout and Diagnostic Tool to the traction battery high-voltage two-pin C3994M.</li> </ul> <p><b>⚠ WARNING: The traction battery contains high-voltage components and wiring. High-voltage insulated safety gloves and face shield must be worn when performing the following steps. Failure to follow this warning may result in severe personal injury or death.</b></p> <ul style="list-style-type: none"> <li>Disconnect contactor box C1864 and measure the resistance between pin B (BK wire) and pin C (R wire) on contactor box C1864. Record resistance value on the Repair Order.</li> <li><b>Is the resistance between 330 and 390 ohms?</b></li> </ul>	Yes = GO to <b>B7</b> .  No = GO to <b>B6</b> .
<b>B6 CHECK CIRCUITS 3709 (R) AND 57 (BK) FOR OPEN(S)</b> <ul style="list-style-type: none"> <li>With key OFF, disconnect upper battery heater C1859 and measure the resistance of the R wire between pin C on contactor box C1864 and upper battery heater C1859.</li> </ul> <ul style="list-style-type: none"> <li>With key OFF, disconnect upper battery heater C1861 and measure the resistance of the BK wire between pin B on contactor box C1864 and upper battery heater C1861.</li> <li><b>Are the resistances less than 5 ohms?</b></li> </ul>	Yes = DISCONNECT and MEASURE the resistance of each upper battery module heater (the resistance should be between 28 and 32 ohms). REPLACE the battery module heater(s) in question.  No = REPLACE high-voltage harness 10B700.
<b>B7 CHECK BATTERY HEATER #1 CONTROL (CLOSE SIGNAL)</b> <ul style="list-style-type: none"> <li>Connect Traction Battery High-Voltage Service Cord to traction battery support tray in-line C1935F and in-line C1935M.</li> <li>Connect Traction Battery Low-Voltage Service Cord to traction battery support tray in-line C1939F and in-line C1939M.</li> <li>Connect 104-Pin Breakout Box (BOB) to BCM and BCM C1986, C1987 using the BCM/TIM BOB Adapter Cable and Overlay.</li> <li>Enter BCM active command mode BCM PACKETED COMMANDS, set the active command BAT HTR 1 to ENABLE, and measure the voltage between BOB pin A2 and ground (BOB pin A33).</li> <li><b>Is the voltage greater than 10 volts?</b></li> </ul>	Yes = GO to <b>B9</b> .  No = GO to <b>B8</b> .
<b>B8 CHECK CIRCUIT 3001 (P/O) FOR SHORT TO GROUND</b> <ul style="list-style-type: none"> <li>With key OFF, disconnect BOB from BCM; leave BOB connected to BCM C1986 and C1987.</li> <li>With key OFF, disconnect contactor box C1982 and measure the resistance between BOB pin A2 and ground (BOB pin A33).</li> <li><b>Is the resistance greater than 10,000 ohms?</b></li> </ul>	Yes = REPLACE the BCM.  No = REPAIR the P/O wire.
<b>B9 CHECK CIRCUIT 3001 (P/O) FOR OPEN</b> <ul style="list-style-type: none"> <li>With key OFF, disconnect contactor box C1982 and measure the resistance of the P/O wire between pin 2 on contactor box C1982 and BOB pin A2.</li> <li><b>Is the resistance less than 5 ohms?</b></li> </ul>	Yes = REPLACE the contactor box.  No = REPAIR the P/O wire.

(Continued)

**DIAGNOSIS AND TESTING (Continued)****PINPOINT TEST B: DTC C1837 BATTERY HEATER CIRCUIT FAILURE**

<b>TEST STEP</b>	<b>ACTION TO TAKE</b>
<p><b>B10 CHECK LOWER BATTERY HEATER FOR OPEN</b></p> <ul style="list-style-type: none"> <li>Remove the traction battery and connect Traction Battery High-Voltage Lockout and Diagnostic Tool to the traction battery high-voltage two-pin C3994M.</li> </ul> <p> <b>WARNING: The traction battery contains high-voltage components and wiring. High-voltage insulated safety gloves and face shield must be worn when performing the following steps. Failure to follow this warning may result in severe personal injury or death.</b></p> <ul style="list-style-type: none"> <li>Disconnect contactor box C1864 and measure the resistance between pin B (BK wire) and pin A (DB/W wire) on contactor box C1864.</li> <li><b>Is the resistance between 135 and 165 ohms?</b></li> </ul>	<p>Yes = GO to <b>B12</b>.</p> <p>No = GO to <b>B11</b>.</p>
<p><b>B11 CHECK CIRCUITS 1201 (DB/W) AND 57 (BK) FOR OPEN(S)</b></p> <ul style="list-style-type: none"> <li>With key OFF, disconnect lower battery heater C1862 and measure the resistance of the DB/W wire between pin A on contactor box C1864 and lower battery heater C1862.</li> <li>With key OFF, disconnect lower battery heater C1863 and measure the resistance of the BK wire between pin B on contactor box C1864 and lower battery heater C1863.</li> <li><b>Are the resistances less than 5 ohms?</b></li> </ul>	<p>Yes = REPLACE the lower battery heater.</p> <p>No = REPLACE high-voltage harness 10B700.</p>
<p><b>B12 CHECK BATTERY HEATER #2 CONTROL (CLOSE SIGNAL)</b></p> <ul style="list-style-type: none"> <li>Connect Traction Battery High-Voltage Service Cord to traction battery support tray in-line C1935F and in-line C1935M.</li> <li>Connect Traction Battery Low-Voltage Service Cord to traction battery support tray in-line C1939F and in-line C1939M.</li> <li>Connect 104-Pin Breakout Box (BOB) to BCM and BCM C1986, C1987 using the BCM/TIM BOB Adapter Cable and Overlay.</li> <li>Enter BCM active command mode BCM PACKETED COMMAND, set the active command BAT HTR 2 to ENABLE, and measure the voltage between BOB pin A3 and ground (BOB pin A33).</li> <li><b>Is the voltage greater than 10 volts?</b></li> </ul>	<p>Yes = GO to <b>B14</b>.</p> <p>No = GO to <b>B13</b>.</p>
<p><b>B13 CHECK CIRCUIT 3000 (P) FOR SHORT TO GROUND</b></p> <ul style="list-style-type: none"> <li>With key OFF, disconnect BOB from BCM; leave BOB connected to BCM C1986 and C1987.</li> <li>With key OFF, disconnect contactor box C1982 and measure the resistance between BOB pin A3 and ground (BOB pin A33).</li> <li><b>Is the resistance greater than 10,000 ohms?</b></li> </ul>	<p>Yes = REPLACE the BCM.</p> <p>No = REPAIR the P wire.</p>
<p><b>B14 CHECK CIRCUIT 3000 (P) FOR OPEN</b></p> <ul style="list-style-type: none"> <li>With key OFF, disconnect contactor box C1982 and measure the resistance of the P wire between pin 10 on contactor box C1982 and BOB pin A3.</li> <li><b>Is the resistance less than 5 ohms?</b></li> </ul>	<p>Yes = REPLACE the contactor box.</p> <p>No = REPAIR the P wire.</p>

**PINPOINT TEST C: DTC C1838 CHARGER SYSTEM FAULT**

<b>TEST STEP</b>	<b>ACTION TO TAKE</b>
<p><b>C1 CHECK FOR CHARGING SYSTEM FAULT</b></p> <p><b>NOTE:</b> Record all DTCs from the BCM, including PREV_OP State code then clear the DTCs from the battery control module (BCM) continuous memory before connecting the vehicle to a power control station (PCS). The vehicle may need to be left on charge for up to five minutes to set a charging system fault (DTC C1838).</p> <ul style="list-style-type: none"> <li>Connect the vehicle to the PCS and press the START button to begin charging.</li> </ul>	<p>Yes = GO to <b>C2</b>.</p>

(Continued)

**DIAGNOSIS AND TESTING (Continued)****PINPOINT TEST C: DTC C1838 CHARGER SYSTEM FAULT**

TEST STEP	ACTION TO TAKE
<ul style="list-style-type: none"> <li>Wait approximately five minutes and retrieve continuous DTCs from the BCM.</li> <li><b>Does DTC C1838 Charging System Fault occur?</b></li> </ul>	No = System OK.
<b>C2 IDENTIFY CHARGING SYSTEM FAULT</b> <ul style="list-style-type: none"> <li>With vehicle on-charge, monitor the following BCM PIDs:</li> </ul> <p><b>Charging System Fault PID/Description</b></p> <ul style="list-style-type: none"> <li>—CHG __ABD = Charger Charging After Being Disabled</li> <li>—CHG __CYF = Charger Cycling Fault</li> <li>—CHG __LCF = Charger Line Capacity Fault</li> <li>—CHG __LUF = Charger Latchup Fault</li> <li>—CHG __MFF = Charger Mode Feedback Fault</li> <li>—CHG __OAF = Charger Over Amp-Hours Fault</li> <li>—CHG __OCF = Charger Over Current Fault</li> <li>—CHG __OTF = Charger Over-Temperature Fault</li> <li>—CHG __OVF = Charger Over Voltage Fault</li> <li>—CHG __UCF = Charger Under Current Fault</li> </ul> <ul style="list-style-type: none"> <li><b>Do any of the charging system fault PIDs indicate YES?</b></li> </ul>	Yes = REFER to Symptom Chart. No = REPEAT test step C1. IF DTC C1838 does not occur, system OK. CHECK wiring for intermittent connections.

**PINPOINT TEST D: CHARGER CHARGING AFTER BEING DISABLED FAULT**

TEST STEP	ACTION TO TAKE
<b>D1 CHECK CHARGER CHARGING AFTER BEING DISABLED STATUS</b> <ul style="list-style-type: none"> <li>Verify the vehicle is connected to the power control station (PCS) and the START button has been depressed to begin charging.</li> </ul> <p><b>NOTE:</b> Wait approximately up to five minutes to allow the CHG__ABD PID to be set.</p> <ul style="list-style-type: none"> <li>With key OFF and vehicle on-charge, monitor BCM PID CHG__ABD.</li> <li><b>Does the CHG__ABD PID indicate YES?</b></li> </ul>	Yes = DISCONNECT the PCS from the vehicle. GO to <b>D2</b> .  No = System OK. CHECK wiring for intermittent connections.
<b>D2 CHECK CONTACTOR BOX AUXILIARY CURRENT SENSOR FOR IN-RANGE FAILURE</b> <ul style="list-style-type: none"> <li>With key ON, monitor BCM PID AUX__CNT.</li> <li>Turn the headlamps on.</li> <li><b>Does the amperage for the AUX__CNT PID increase by at least 0.5 amps?</b></li> </ul>	Yes = GO to <b>D3</b> . No = REPLACE the contactor box.
<b>D3 CHECK CIRCUIT 3827 (GY/W) (OUTSIDE OF TRACTION BATTERY SUPPORT TRAY) FOR OPEN</b> <ul style="list-style-type: none"> <li>With key OFF, disconnect traction battery support tray in-line C1939 and connect 104-Pin Breakout Box (BOB) to in-line C1939M using Traction Battery Low-Voltage Service Cord; do not connect Traction Battery Low-Voltage Service Cord to in-line C1939F.</li> <li>With key OFF, disconnect traction battery charger C1991 and measure the resistance of the GY/W wire between pin 4 on traction battery charger C1991 and BOB pin 57.</li> <li><b>Is the resistance less than 5 ohms?</b></li> </ul>	Yes = GO to <b>D4</b> .  No = REPAIR the GY/W wire.
<b>D4 CHECK CIRCUIT 3827 (GY/W) (OUTSIDE OF TRACTION BATTERY SUPPORT TRAY) FOR SHORT TO GROUND</b>	

(Continued)

**DIAGNOSIS AND TESTING (Continued)****PINPOINT TEST D: CHARGER CHARGING AFTER BEING DISABLED FAULT**

TEST STEP	ACTION TO TAKE
<ul style="list-style-type: none"> <li>With key OFF, measure the resistance between BOB pin 57 and ground (BOB pin 65).</li> <li><b>Is the resistance greater than 10,000 ohms?</b></li> </ul>	Yes = GO to <b>D5</b> . No = REPAIR the GY/W wire.
<b>D5 CHECK CIRCUIT 3827 (GY/W) (INSIDE OF TRACTION BATTERY SUPPORT TRAY) FOR OPEN</b> <ul style="list-style-type: none"> <li>Disconnect the BOB from in-line C1939M, remove the traction battery, and connect Traction Battery High-Voltage Lockout and Diagnostic Tool to the traction battery high-voltage two-pin C3994M.</li> </ul> <p><b>⚠ WARNING: The traction battery contains high-voltage components and wiring. High-voltage insulated safety gloves and face shield must be worn when performing the following steps. Failure to follow this warning may result in severe personal injury or death.</b></p> <ul style="list-style-type: none"> <li>Connect 104-Pin Breakout Box (BOB) to traction battery support tray in-line C1939F using Traction Battery Low-Voltage Service Cord; do not connect Traction Battery Low-Voltage Service Cord to in-line C1939M.</li> <li>With key OFF, disconnect BCM C1986 and measure the resistance of the GY/W wire between pin 8 on BCM C1986 and BOB pin 57.</li> <li><b>Is the resistance less than 5 ohms?</b></li> </ul>	Yes = GO to <b>D6</b> . No = REPAIR the GY/W wire.
<b>D6 CHECK CIRCUIT 3827 (GY/W) (INSIDE OF TRACTION BATTERY SUPPORT TRAY) FOR SHORT TO GROUND</b> <ul style="list-style-type: none"> <li>With key OFF, measure the resistance between BOB pin 57 and ground (BOB pin 65).</li> <li><b>Is the resistance greater than 10,000 ohms?</b></li> </ul>	Yes = REPLACE the traction battery charger. No = REPAIR the GY/W wire.

**PINPOINT TEST E: CHARGER OVER-TEMPERATURE FAULT**

TEST STEP	ACTION TO TAKE
<b>E1 CHECK AMBIENT TEMPERATURE</b> <ul style="list-style-type: none"> <li>With key ON, monitor interface adapter assembly (IAA) module PID INTMP__2.</li> <li><b>Does the INTMP__2 PID indicate greater than 40°C (104°F)?</b></li> </ul>	Yes = GO to <b>E2</b> . No = GO to <b>E3</b> .
<b>E2 CHECK FOR CHARGING SYSTEM FAULT AT AMBIENT (ROOM) TEMPERATURE</b> <ul style="list-style-type: none"> <li>Open the hood and allow the underhood compartment to cool to ambient (room) temperature.</li> <li>Connect the vehicle to the power control station (PCS) and press the START button to begin charging.</li> <li>Wait five minutes and retrieve continuous DTCs from the BCM.</li> <li><b>Does DTC C1838 Charging System Fault occur?</b></li> </ul>	Yes = GO to <b>E3</b> . No = System OK.
<b>E3 CHECK CHARGER OVER-TEMPERATURE FAULT STATUS</b> <ul style="list-style-type: none"> <li>With key ON, monitor BCM PID CHG__OTF.</li> <li><b>Does the CHG__OTF PID indicate YES?</b></li> </ul>	Yes = REPLACE the traction battery charger. No = GO to Pinpoint Test C.

**PINPOINT TEST F: CHARGER LATCHUP FAULT**

TEST STEP	ACTION TO TAKE
<b>F1 CHECK CHARGER OVER-TEMPERATURE STATUS</b> <ul style="list-style-type: none"> <li>Verify the vehicle is connected to the power control station (PCS) and the START button has been depressed to begin charging.</li> </ul>	Yes = GO to Pinpoint Test E.

(Continued)



**DIAGNOSIS AND TESTING (Continued)****PINPOINT TEST F: CHARGER LATCHUP FAULT**

TEST STEP	ACTION TO TAKE
<p><b>NOTE:</b> Wait approximately five minutes to allow the CHG__OTF PID to be set.</p> <ul style="list-style-type: none"> <li>With key OFF and vehicle on-charge, monitor BCM PID CHG__OTF.</li> <li><b>Does the CHG__OTF PID indicate YES?</b></li> </ul>	<p>No = DISCONNECT the PCS from the vehicle. GO to F2.</p>
<p><b>F2 CHECK CIRCUIT 3800 (LG/BK) (OUTSIDE OF TRACTION BATTERY SUPPORT TRAY) FOR OPEN</b></p> <ul style="list-style-type: none"> <li>With key OFF, disconnect traction battery support tray in-line C1939 and connect 104-Pin Breakout Box (BOB) to in-line C1939M using Traction Battery Low-Voltage Service Cord; do not connect Traction Battery Low-Voltage Service Cord to in-line C1939F.</li> <li>With key OFF, disconnect traction battery charger C1991 and measure the resistance of the LG/BK wire between pin 2 on traction battery charger C1991 and BOB pin 55.</li> <li><b>Is the resistance less than 5 ohms?</b></li> </ul>	<p>Yes = GO to F3.</p> <p>No = REPAIR the LG/BK wire.</p>
<p><b>F3 CHECK CIRCUIT 3800 (LG/BK) (OUTSIDE OF TRACTION BATTERY SUPPORT TRAY) FOR SHORT TO GROUND</b></p> <ul style="list-style-type: none"> <li>With key OFF, measure the resistance between BOB pin 55 and ground (BOB pin 65).</li> <li><b>Is the resistance greater than 10,000 ohms?</b></li> </ul>	<p>Yes = GO to F4.</p> <p>No = REPAIR the LG/BK wire.</p>
<p><b>F4 CHECK CIRCUIT 3800 (LG/BK) (INSIDE OF TRACTION BATTERY SUPPORT TRAY) FOR OPEN</b></p> <ul style="list-style-type: none"> <li>Disconnect the BOB from in-line C1939M, remove the traction battery, and connect Traction Battery High-Voltage Lockout and Diagnostic Tool to the traction battery high-voltage two-pin C3994M.</li> </ul> <p> <b>WARNING: The traction battery contains high-voltage components and wiring. High-voltage insulated safety gloves and face shield must be worn when performing the following steps. Failure to follow this warning may result in severe personal injury or death.</b></p> <ul style="list-style-type: none"> <li>Connect 104-Pin Breakout Box (BOB) to traction battery support tray in-line C1939F using Traction Battery Low-Voltage Service Cord; do not connect Traction Battery Low-Voltage Service Cord to in-line C1939M.</li> <li>With key OFF, disconnect BCM C1987 and measure the resistance of the LG/BK wire between pin 14 on BCM C1987 and BOB pin 55.</li> <li><b>Is the resistance less than 5 ohms?</b></li> </ul>	<p>Yes = GO to F5.</p> <p>No = REPAIR the LG/BK wire.</p>
<p><b>F5 CHECK CIRCUIT 3800 (LG/BK) (INSIDE OF TRACTION BATTERY SUPPORT TRAY) FOR SHORT TO GROUND</b></p> <ul style="list-style-type: none"> <li>With key OFF, measure the resistance between BOB pin 55 and ground (BOB pin 65).</li> <li><b>Is the resistance greater than 10,000 ohms?</b></li> </ul>	<p>Yes = REPLACE the traction battery charger.</p> <p>No = REPAIR the LG/BK wire.</p>

**PINPOINT TEST G: CHARGER CYCLING FAULT**

TEST STEP	ACTION TO TAKE
<p><b>G1 CHECK FOR OTHER BATTERY CONTROL MODULE (BCM) DIAGNOSTIC TROUBLE CODES (DTCs)</b></p> <p><b>NOTE:</b> If vehicle was recently in a hot temperature environment, allow vehicle to cool down before proceeding.</p> <ul style="list-style-type: none"> <li>Connect the vehicle to a power control station (PCS) and press the START button to begin charging.</li> </ul>	<p>Yes = REFER to Current Leakage Detection in this section.</p>

(Continued)

**DIAGNOSIS AND TESTING (Continued)****PINPOINT TEST G: CHARGER CYCLING FAULT**

TEST STEP	ACTION TO TAKE
<ul style="list-style-type: none"> <li>• Wait approximately five minutes and retrieve continuous DTCs from the BCM.</li> <li>• <b>Does DTC C1839 Leakage Fault occur along with DTC C1838 Charging System Fault?</b></li> </ul>	No = If DTC C1838 does not occur, system OK. If DTC C1838 does occur, GO to Pinpoint Test C and REPEAT. If other charging system faults are indicated in Pinpoint Test C, CARRY OUT the diagnostic procedure for the other faults. If no other charging system faults occur, REPLACE the traction battery charger.

**PINPOINT TEST H: CHARGER UNDER CURRENT FAULT**

TEST STEP	ACTION TO TAKE
<b>H1 CHECK CONTACTOR BOX AUXILIARY CURRENT SENSOR FOR IN-RANGE FAILURE</b> <ul style="list-style-type: none"> <li>• With key ON, monitor battery control module (BCM) PID AUX__CNT.</li> <li>• Turn the A/C on and turn the steering wheel back and forth.</li> <li>• <b>Does the amperage for the AUX__CNT PID increase and decrease?</b></li> </ul>	Yes = GO to <b>H2</b> . No = REPLACE the contactor box.
<b>H2 CHECK CHARGER CONTACTOR RELAY OUTPUT CIRCUIT</b> <ul style="list-style-type: none"> <li>• Disconnect the 12-volt auxiliary battery negative cable and remove the high-voltage power distribution box (HVPDB) cover.</li> </ul> <p><b>⚠ WARNING: The following test steps contain high-voltage procedures. High-voltage insulated safety gloves and face shield must be worn when performing the following steps. Failure to follow this warning may result in severe personal injury or death.</b></p> <ul style="list-style-type: none"> <li>• Disconnect HVPDB traction battery charger high-voltage C1923.</li> <li>• Reinstall the HVPDB cover.</li> <li>• Reconnect the 12-volt auxiliary battery negative cable.</li> <li>• Enter battery control module (BCM) active command mode CONTACTOR OUTPUT CONTROL and set active command CHARGER to CLOSE.</li> <li>• With key ON, measure the voltage between circuit 3170 (O wire) and circuit 3171 (W wire) on HVPDB traction battery charger high-voltage C1923F.</li> <li>• <b>Is the voltage greater than 300 volts?</b></li> </ul>	Yes = GO to <b>H10</b> . No = GO to <b>H3</b> .
<b>H3 CHECK HVPDB CIRCUITS 3134 (O) AND 3133 (W) (OUTSIDE OF TRACTION BATTERY SUPPORT TRAY) FOR OPEN(S)</b> <ul style="list-style-type: none"> <li>• With key OFF, disconnect high-voltage auxiliary load in-line C1935 on the traction battery support tray and measure the resistance between circuit 3170 (O wire) on HVPDB traction battery charger high-voltage C1923F and circuit 3134 (O wire) on in-line C1935M.</li> <li>• With key OFF, measure the resistance between circuit 3171 (W wire) on HVPDB traction battery charger high-voltage C1923 and circuit 3133 (W wire) on in-line C1935M.</li> <li>• <b>Are the resistances less than 5 ohms?</b></li> </ul>	Yes = GO to <b>H4</b> . No = REPLACE the HVPDB.
<b>H4 CHECK CIRCUITS 3134 (O) AND 3133 (W) (INSIDE TRACTION BATTERY SUPPORT TRAY) FOR OPEN(S)</b> <ul style="list-style-type: none"> <li>• Remove the traction battery and connect Traction Battery High-Voltage Lockout and Diagnostic Tool to the traction battery high-voltage two-pin C3994M.</li> </ul>	Yes = GO to <b>H5</b> .

(Continued)

**DIAGNOSIS AND TESTING (Continued)****PINPOINT TEST H: CHARGER UNDER CURRENT FAULT**

TEST STEP	ACTION TO TAKE
<p><b>NOTE:</b> Contactor box C3985 is mounted on the passenger side of the BCM.</p> <ul style="list-style-type: none"> <li>• With key OFF, disconnect contactor box C3985 and measure the resistance of the O wire between contactor box C3985F and traction battery support tray in-line C1935F.</li> <li>• With key OFF, measure the resistance of the W wire between contactor box C3985F and traction battery support tray in-line C1935F.</li> <li>• <b>Is the resistance less than 5 ohms?</b></li> </ul>	<p>No = REPLACE high-voltage harness (14B326) between traction battery support tray in-line C1935F and contactor box C3985.</p>
<p><b>H5 CHECK CHARGER CONTACTOR RELAY</b></p> <ul style="list-style-type: none"> <li>• Reconnect contactor box C3985.</li> <li>• Connect Traction Battery High-Voltage Service Cord to traction battery support tray in-line C1935F and in-line C1935M.</li> <li>• Connect Traction Battery Low-Voltage Service Cord to traction battery support tray in-line C1939F and in-line C1939M.</li> <li>• Enter BCM active command mode CONTACTOR OUTPUT CONTROL, set the active command CHARGER to CLOSE, and listen for the charger contactor relay closing.</li> <li>• <b>Does the charger contactor relay close?</b></li> </ul>	<p>Yes = GO to <b>H6</b>. No = GO to <b>H7</b>.</p>
<p><b>H6 CHECK CONTACTOR BOX HIGH-VOLTAGE FUSE</b></p> <ul style="list-style-type: none"> <li>• Remove the 25A CHARGER fuse from the contactor box. Refer to Contactor Box Fuses Removal and Installation procedure in this section.</li> <li>• Measure the resistance of the 25A CHARGER fuse.</li> <li>• <b>Is the resistance greater than 1,000 ohms?</b></li> </ul>	<p>Yes = REPLACE the 25A CHARGER fuse. No = REPLACE the contactor box.</p>
<p><b>H7 CHECK CHARGER CONTACTOR RELAY CONTROL (CLOSE SIGNAL)</b></p> <ul style="list-style-type: none"> <li>• Reconnect contactor box C3985.</li> <li>• Connect Traction Battery High-Voltage Service Cord to traction battery support tray in-line C1935F and in-line C1935M.</li> <li>• Connect Traction Battery Low-Voltage Service Cord to traction battery support tray in-line C1939F and in-line C1939M.</li> <li>• Connect 104-Pin Breakout Box (BOB) to BCM and BCM C1986, C1987 using the BCM/TIM BOB Adapter Cable and Overlay.</li> <li>• Enter BCM active command mode CONTACTOR OUTPUT CONTROL, set the active command CHARGER to CLOSE, and measure the voltage between BOB pin B9 and ground (BOB pin A33).</li> <li>• <b>Is the voltage greater than 10 volts?</b></li> </ul>	<p>Yes = GO to <b>H9</b>. No = GO to <b>H8</b>.</p>
<p><b>H8 CHECK CIRCUIT 3137 (GY/Y) FOR SHORT TO GROUND</b></p> <ul style="list-style-type: none"> <li>• With key OFF, disconnect BOB from BCM; leave BOB connected to BCM C1986 and C1987.</li> <li>• With key OFF, disconnect contactor box C1982 and measure the resistance between BOB pin B9 and ground (BOB pin A33).</li> <li>• <b>Is the resistance greater than 10,000 ohms?</b></li> </ul>	<p>Yes = REPLACE the BCM. No = REPAIR the GY/Y wire.</p>
<p><b>H9 CHECK CIRCUIT 3137 (GY/Y) FOR OPEN</b></p> <ul style="list-style-type: none"> <li>• With key OFF, disconnect contactor box C1982 and measure the resistance of the GY/Y wire between pin 20 on contactor box C1982 and BOB pin B9.</li> <li>• <b>Is the resistance less than 5 ohms?</b></li> </ul>	<p>Yes = REPLACE the contactor box. No = REPAIR the GY/Y wire.</p>
<p><b>H10 CHECK OUTPUT OF TRACTION BATTERY CHARGER</b></p> <ul style="list-style-type: none"> <li>• Connect the power control station (PCS) to the charger inlet connector and press the START button on the PCS.</li> </ul>	<p>Yes = GO to <b>H11</b>.</p>

(Continued)

**DIAGNOSIS AND TESTING (Continued)****PINPOINT TEST H: CHARGER UNDER CURRENT FAULT**

TEST STEP	ACTION TO TAKE
<p><b>NOTE:</b> Measure the voltage immediately after pressing the START button on the PCS. If no voltage output, monitor the voltage for approximately two minutes.</p> <ul style="list-style-type: none"> <li>With vehicle on-charge, measure the voltage between circuit 3170 (O wire) and circuit 3171 (W wire) on HVPDB traction battery charger high-voltage C1923M.</li> <li><b>Is the voltage greater than 200 volts?</b></li> </ul>	<p>No = GO to <b>H12</b>.</p>
<p><b>H11 CHECK CHARGER OVER-TEMPERATURE FAULT STATUS</b></p> <ul style="list-style-type: none"> <li>With key OFF, reconnect HVPDB traction battery charger high-voltage C1923.</li> <li>Connect the vehicle to the PCS and press the START button to begin charging.</li> <li>With vehicle on-charge, monitor BCM PID CHG__OTF for approximately five minutes.</li> <li><b>Does the CHG__OTF PID indicate YES?</b></li> </ul>	<p>Yes = GO to Pinpoint Test E.</p> <p>No = System OK. CHECK wiring for intermittent connections.</p>
<p><b>H12 CHECK CIRCUITS 3401 (DB/LG) AND 3985 (PK) (OUTSIDE OF TRACTION BATTERY SUPPORT TRAY) FOR OPEN(S)</b></p> <ul style="list-style-type: none"> <li>With key OFF, disconnect traction battery support tray in-line C1939 and connect 104-Pin Breakout Box (BOB) to in-line C1939M using Traction Battery Low-Voltage Service Cord; do not connect Traction Battery Low-Voltage Service Cord to in-line C1939F.</li> <li>With key OFF, disconnect traction battery charger C1991 and C1993.</li> <li>With key OFF, measure the resistance of the DB/LG wire between pin 3 on traction battery charger C1993 and BOB pin 63.</li> <li>With key OFF, measure the resistance of the PK wire between pin 3 on traction battery charger C1991 and BOB pin 50.</li> <li><b>Are the resistances less than 5 ohms?</b></li> </ul>	<p>Yes = GO to <b>H13</b>.</p> <p>No = REPAIR the wire(s) in question.</p>
<p><b>H13 CHECK CIRCUITS 3401 (DB/LG) AND 3985 (PK) (INSIDE OF TRACTION BATTERY SUPPORT TRAY) FOR OPEN(S)</b></p> <ul style="list-style-type: none"> <li>Disconnect the BOB from in-line C1939M, remove the traction battery, and connect Traction Battery High-Voltage Lockout and Diagnostic Tool to the traction battery high-voltage two-pin C3994M.</li> <li>Connect 104-Pin Breakout Box (BOB) to traction battery support tray in-line C1939F using Traction Battery Low-Voltage Service Cord; do not connect Traction Battery Low-Voltage Service Cord to in-line C1939M.</li> </ul> <p> <b>WARNING: The traction battery contains high-voltage components and wiring. High-voltage insulated safety gloves and face shield must be worn when performing the following steps. Failure to follow this warning may result in severe personal injury or death.</b></p> <ul style="list-style-type: none"> <li>With key OFF, disconnect BCM C1986 and C1987.</li> <li>Measure the resistance of the DB/LG wire between pin 11 on BCM C1986 and BOB pin 63.</li> <li>Measure the resistance of the PK wire between pin 13 on BCM C1986 and BOB pin 50.</li> <li><b>Are the resistances less than 5 ohms?</b></li> </ul>	<p>Yes = REPLACE the traction battery charger.</p> <p>No = REPAIR the wire(s) in question.</p>

**PINPOINT TEST J: CHARGER OVER CURRENT FAULT**

TEST STEP	ACTION TO TAKE
<p><b>J1 CHECK CONTACTOR BOX AUXILIARY CURRENT SENSOR FOR IN-RANGE FAILURE</b></p> <ul style="list-style-type: none"> <li>With key ON, monitor BCM PID AUX__CNT.</li> </ul>	<p>Yes = REPLACE the traction battery charger.</p>

(Continued)

**DIAGNOSIS AND TESTING (Continued)****PINPOINT TEST J: CHARGER OVER CURRENT FAULT**

TEST STEP	ACTION TO TAKE
<ul style="list-style-type: none"> <li>Turn the A/C on and turn the steering wheel back and forth.</li> <li><b>Does the amperage for the AUX__CNT PID increase and decrease?</b></li> </ul>	No = GO to <b>J2</b> .
<b>J2 CHECK AUXILIARY CURRENT SENSOR VOLTAGE STATUS</b> <ul style="list-style-type: none"> <li>Remove the traction battery and connect Traction Battery High-Voltage Lockout and Diagnostic Tool to the traction battery high-voltage two-pin C3994M.</li> </ul> <p><b>⚠ WARNING: The traction battery contains high-voltage components and wiring. High-voltage insulated safety gloves and face shield must be worn when performing the following steps. Failure to follow this warning may result in severe personal injury or death.</b></p> <ul style="list-style-type: none"> <li>With key OFF, disconnect contactor box C1982.</li> <li>With key ON, monitor BCM PID AUX__SEN.</li> <li><b>Does the AUX__SEN PID indicate greater than 1 volt?</b></li> </ul>	Yes = REPLACE the BCM.  No = REPLACE the contactor box.

**PINPOINT TEST K: CHARGER OVER VOLTAGE FAULT**

TEST STEP	ACTION TO TAKE
<b>K1 CHECK TRACTION BATTERY POSITIVE (+) SENSE LINE CIRCUIT BETWEEN IN-LINE C1885F AND BATTERY MODULE 39 FOR SHORTED RESISTOR</b> <ul style="list-style-type: none"> <li>Remove the traction battery and connect Traction Battery High-Voltage Lockout and Diagnostic Tool to the traction battery high-voltage two-pin C3994M.</li> </ul> <p><b>⚠ WARNING: The traction battery contains high-voltage components and wiring. High-voltage insulated safety gloves and face shield must be worn when performing the following steps. Failure to follow this warning may result in severe personal injury or death.</b></p> <ul style="list-style-type: none"> <li>With key OFF, disconnect in-line C1885 (label W) and measure the resistance between the LB wire on in-line C1885F and battery module 39 positive (+) post.</li> <li><b>Is the resistance between 28,000 and 34,000 ohms?</b></li> </ul>	Yes = GO to <b>K2</b> .  No = REPLACE high-voltage harness (14A280-WD).
<b>K2 CHECK TRACTION BATTERY NEGATIVE (-) SENSE LINE CIRCUIT BETWEEN IN-LINE C1882F AND BATTERY MODULE 1 FOR OPEN</b> <ul style="list-style-type: none"> <li>With key OFF, disconnect in-line C1882 (label R) and measure the resistance between the PIK/BK wire on in-line C1882F and battery module 1 negative (-) post.</li> <li><b>Is the resistance between 28,000 and 34,000 ohms?</b></li> </ul>	Yes = REPLACE the BCM.  No = REPLACE high-voltage harness (14A280-RF).

**PINPOINT TEST M: CHARGER LINE CAPACITY FAULT**

TEST STEP	ACTION TO TAKE
<b>M1 VERIFY POWER CONTROL STATION (PCS) OPERATION</b> <ul style="list-style-type: none"> <li>Perform Power Control Station (PCS) Operation Verification Test. Refer to Pinpoint Test S.</li> <li><b>Is the PCS OK?</b></li> </ul>	Yes = GO to <b>M2</b> .  No = PERFORM the required action as indicated in Pinpoint Test S.
<b>M2 CHECK FOR CHARGING SYSTEM FAULT</b>	

(Continued)

**DIAGNOSIS AND TESTING (Continued)****PINPOINT TEST M: CHARGER LINE CAPACITY FAULT**

TEST STEP	ACTION TO TAKE
<ul style="list-style-type: none"> <li>Connect the power control station (PCS) to the vehicle and the depress the START button to begin charging.</li> <li>Wait approximately five minutes.</li> <li>With key OFF and vehicle on-charge, retrieve continuous DTCs from the BCM.</li> <li><b>Does DTC C1838 Charging System Fault occur?</b></li> </ul>	Yes = REPLACE the traction battery charger. No = System OK. CHECK wiring for intermittent connections.

**PINPOINT TEST N: CHARGER MODE FEEDBACK FAULT**

TEST STEP	ACTION TO TAKE
<b>N1 CHECK CHARGER UNDER CURRENT STATUS</b> <ul style="list-style-type: none"> <li>Verify the vehicle is connected to the power control station (PCS) and the START button has been depressed to begin charging.</li> </ul> <p><b>NOTE:</b> Wait approximately one to five minutes to allow the CHG__UCF PID to set.</p> <ul style="list-style-type: none"> <li>With key OFF and vehicle on-charge, monitor BCM PID CHG__UCF.</li> <li><b>Does the CHG__UCF PID indicate YES?</b></li> </ul>	Yes = GO to Pinpoint Test H. No = DISCONNECT the PCS from the vehicle. GO to N2.
<b>N2 CHECK POWER SIGNAL TO TRACTION BATTERY CHARGER</b> <ul style="list-style-type: none"> <li>With key OFF, disconnect traction battery charger C1993.</li> <li>With key ON, measure the voltage between pin 1 (W wire) on traction battery charger C1993 and ground.</li> <li><b>Is the voltage greater than 10 volts?</b></li> </ul>	Yes = GO to N7. No = GO to N3.
<b>N3 CHECK CIRCUIT 3826 (W) (OUTSIDE OF TRACTION BATTERY SUPPORT TRAY) FOR OPEN</b> <ul style="list-style-type: none"> <li>With key OFF, disconnect traction battery support tray in-line C1939 and connect 104-Pin Breakout Box (BOB) to in-line C1939M using Traction Battery Low-Voltage Service Cord; do not connect Traction Battery Low-Voltage Service Cord to in-line C1939F.</li> <li>With key OFF, measure the resistance of the W wire between pin 1 on traction battery charger C1993 and BOB pin 38.</li> <li><b>Is the resistance less than 5 ohms?</b></li> </ul>	Yes = GO to N4. No = REPAIR the W wire.
<b>N4 CHECK CIRCUIT 3826 (W) (OUTSIDE OF TRACTION BATTERY SUPPORT TRAY) FOR SHORT TO GROUND</b> <ul style="list-style-type: none"> <li>With key OFF, measure the resistance between BOB pin 38 and ground (BOB pin 65).</li> <li><b>Is the resistance greater than 10,000 ohms?</b></li> </ul>	Yes = GO to N5. No = REPAIR the W wire.
<b>N5 CHECK CIRCUIT 3826 (W) (INSIDE OF TRACTION BATTERY SUPPORT TRAY) FOR OPEN</b> <ul style="list-style-type: none"> <li>Disconnect the BOB from in-line C1939M, remove the traction battery, and connect Traction Battery High-Voltage Lockout and Diagnostic Tool to the traction battery high-voltage two-pin C3994M.</li> </ul> <p><b>⚠ WARNING: The traction battery contains high-voltage components and wiring. High-voltage insulated safety gloves and face shield must be worn when performing the following steps. Failure to follow this warning may result in severe personal injury or death.</b></p> <ul style="list-style-type: none"> <li>Connect 104-Pin Breakout Box (BOB) to traction battery support tray in-line C1939F using Traction Battery Low-Voltage Service Cord; do not connect Traction Battery Low-Voltage Service Cord to in-line C1939M.</li> <li>With key OFF, disconnect BCM C1986 and measure the resistance of the W wire between pin 5 on BCM C1986 and BOB pin 38.</li> <li><b>Is the resistance less than 5 ohms?</b></li> </ul>	Yes = GO to N6. No = REPAIR the W wire.

(Continued)

**DIAGNOSIS AND TESTING (Continued)****PINPOINT TEST N: CHARGER MODE FEEDBACK FAULT**

<b>TEST STEP</b>	<b>ACTION TO TAKE</b>
<b>N6 CHECK CIRCUIT 3826 (W) (INSIDE OF TRACTION BATTERY SUPPORT TRAY) FOR SHORT TO GROUND</b> <ul style="list-style-type: none"> <li>With key OFF, measure the resistance between BOB pin 38 and ground (BOB pin 65).</li> <li><b>Is the resistance greater than 10,000 ohms?</b></li> </ul>	Yes = REPLACE the BCM. No = REPAIR the W wire.
<b>N7 CHECK CIRCUIT 3992 (BR/Y) (OUTSIDE OF TRACTION BATTERY SUPPORT TRAY) FOR OPEN</b> <ul style="list-style-type: none"> <li>With key OFF, disconnect traction battery support tray in-line C1939 and connect 104-Pin Breakout Box (BOB) to in-line C1939M using Traction Battery Low-Voltage Service Cord; do not connect Traction Battery Low-Voltage Service Cord to in-line C1939F.</li> <li>With key OFF, measure the resistance of the BR/Y wire between pin 8 on traction battery charger C1993 and BOB pin 49.</li> <li><b>Is the resistance less than 5 ohms?</b></li> </ul>	Yes = GO to N8. No = REPAIR the BR/Y wire.
<b>N8 CHECK CIRCUIT 3992 (BR/Y) (OUTSIDE OF TRACTION BATTERY SUPPORT TRAY) FOR SHORT TO GROUND</b> <ul style="list-style-type: none"> <li>With key OFF, measure the resistance between BOB pin 49 and ground (BOB pin 65).</li> <li><b>Is the resistance greater than 10,000 ohms?</b></li> </ul>	Yes = GO to N9. No = REPAIR the BR/Y wire.
<b>N9 CHECK CIRCUIT 3992 (BR/Y) (INSIDE OF TRACTION BATTERY SUPPORT TRAY) FOR OPEN</b> <ul style="list-style-type: none"> <li>Disconnect the BOB from in-line C1939M, remove the traction battery, and connect Traction Battery High-Voltage Lockout and Diagnostic Tool to the traction battery high-voltage two-pin C3994M.</li> </ul> <p> <b>WARNING: The traction battery contains high-voltage components and wiring. High-voltage insulated safety gloves and face shield must be worn when performing the following steps. Failure to follow this warning may result in severe personal injury or death.</b></p> <ul style="list-style-type: none"> <li>Connect 104-Pin Breakout Box (BOB) to traction battery support tray in-line C1939F using Traction Battery Low-Voltage Service Cord; do not connect Traction Battery Low-Voltage Service Cord to in-line C1939M.</li> <li>With key OFF, disconnect BCM C1986 and measure the resistance of the BR/Y wire between pin 7 on BCM C1986 and BOB pin 49.</li> <li><b>Is the resistance less than 5 ohms?</b></li> </ul>	Yes = GO to N10. No = REPAIR the BR/Y wire.
<b>N10 CHECK CIRCUIT 3992 (BR/Y) (INSIDE OF TRACTION BATTERY SUPPORT TRAY) FOR SHORT TO GROUND</b> <ul style="list-style-type: none"> <li>With key OFF, measure the resistance between BOB pin 49 and ground (BOB pin 65).</li> <li><b>Is the resistance greater than 10,000 ohms?</b></li> </ul>	Yes = REPLACE the traction battery charger. No = REPAIR the BR/Y wire.

**PINPOINT TEST P: DTC C1859 PRNDL INPUT #2 CIRCUIT FAILURE**

<b>TEST STEP</b>	<b>ACTION TO TAKE</b>
<b>P1 CHECK STATUS OF DIGITAL TRANSMISSION RANGE (DTR) SENSOR SIGNAL TR2 TO BATTERY CONTROL MODULE (BCM)</b> <p><b>NOTE:</b> Verify the transmission range selector lever is in the park (P) position.</p> <ul style="list-style-type: none"> <li>With key ON, monitor BCM PID TRANSGR.</li> <li><b>Does the TRANSGR PID indicate D6__PRK?</b></li> </ul>	Yes = System OK. CHECK wiring for intermittent connections. No = GO to P2.
<b>P2 CHECK CIRCUIT 3501 (DB) (OUTSIDE OF TRACTION BATTERY SUPPORT TRAY) FOR OPEN</b>	

(Continued)

**DIAGNOSIS AND TESTING (Continued)****PINPOINT TEST P: DTC C1859 PRNDL INPUT #2 CIRCUIT FAILURE**

<b>TEST STEP</b>	<b>ACTION TO TAKE</b>
<ul style="list-style-type: none"> <li>With key OFF, disconnect traction battery support tray in-line C1939 and connect 104-Pin Breakout Box (BOB) to in-line C1939M using Traction Battery Low-Voltage Service Cord; do not connect Traction Battery Low-Voltage Service Cord to in-line C1939F.</li> <li>With key OFF, disconnect digital transmission range (DTR) sensor C4996 and measure the resistance of the DB wire between pin 5 on DTR sensor C4996 and BOB pin 40.</li> <li><b>Is the resistance less than 5 ohms?</b></li> </ul>	Yes = GO to <b>P3</b> .  No = REPAIR the DB wire.
<b>P3 CHECK CIRCUIT 3501 (DB) (INSIDE OF TRACTION BATTERY SUPPORT TRAY) FOR OPEN</b> <ul style="list-style-type: none"> <li>Disconnect the BOB from in-line C1939M, remove the traction battery, and connect Traction Battery High-Voltage Lockout and Diagnostic Tool to the traction battery high-voltage two-pin C3994M.</li> </ul> <p><b>⚠ WARNING: The traction battery contains high-voltage components and wiring. High-voltage insulated safety gloves and face shield must be worn when performing the following steps. Failure to follow this warning may result in severe personal injury or death.</b></p> <ul style="list-style-type: none"> <li>Connect 104-Pin Breakout Box (BOB) to traction battery support tray in-line C1939F and in-line C1939M using Traction Battery Low-Voltage Service Cord.</li> <li>With key OFF, disconnect BCM C1987 and measure the resistance of the DB wire between pin 17 on BCM C1987 and BOB pin 40.</li> <li><b>Is the resistance less than 5 ohms?</b></li> </ul>	Yes = GO to <b>P4</b> .  No = REPAIR the DB wire.
<b>P4 CHECK FOR INTERMITTENT CONCERN(S)</b> <ul style="list-style-type: none"> <li>With key OFF, reconnect DTR sensor C4996 and BCM C1987.</li> <li>Perform the on-demand self-test for the BCM.</li> <li><b>Does DTC C1859 PRNDL Input #2 Circuit Failure occur?</b></li> </ul>	Yes = REPLACE the BCM. No = System OK. CHECK wiring for intermittent connections.

**PINPOINT TEST Q: DTC C1861 PRNDL INPUT #4 CIRCUIT FAILURE**

<b>TEST STEP</b>	<b>ACTION TO TAKE</b>
<b>Q1 CHECK STATUS OF DIGITAL TRANSMISSION RANGE (DTR) SENSOR SIGNAL TR4 TO BATTERY CONTROL MODULE (BCM)</b> <p><b>NOTE:</b> Verify the transmission range selector lever is in the park (P) position.</p> <ul style="list-style-type: none"> <li>With key ON, monitor BCM PID TRANSGR.</li> <li><b>Does the TRANSGR PID indicate D6__PRK?</b></li> </ul>	Yes = System OK. CHECK wiring for intermittent connections.  No = GO to <b>Q2</b> .
<b>Q2 CHECK CIRCUIT 3503 (Y) (OUTSIDE OF TRACTION BATTERY SUPPORT TRAY) FOR OPEN</b> <ul style="list-style-type: none"> <li>With key OFF, disconnect traction battery support tray in-line C1939 and connect 104-Pin Breakout Box (BOB) to in-line C1939M using Traction Battery Low-Voltage Service Cord; do not connect Traction Battery Low-Voltage Service Cord to in-line C1939F.</li> <li>With key OFF, disconnect digital transmission range (DTR) sensor C4996 and measure the resistance of the Y wire between pin 6 on DTR sensor C4996 and BOB pin 52.</li> <li><b>Is the resistance less than 5 ohms?</b></li> </ul>	Yes = GO to <b>Q3</b> .  No = REPAIR the Y wire.
<b>Q3 CHECK CIRCUIT 3503 (Y) (INSIDE OF TRACTION BATTERY SUPPORT TRAY) FOR OPEN</b> <ul style="list-style-type: none"> <li>Disconnect the BOB from in-line C1939M, remove the traction battery, and connect Traction Battery High-Voltage Lockout and Diagnostic Tool to the traction battery high-voltage two-pin C3994M.</li> </ul>	Yes = GO to <b>Q4</b> .

(Continued)



**DIAGNOSIS AND TESTING (Continued)****PINPOINT TEST Q: DTC C1861 PRNDL INPUT #4 CIRCUIT FAILURE**

TEST STEP	ACTION TO TAKE
<p> <b>WARNING: The traction battery contains high-voltage components and wiring. High-voltage insulated safety gloves and face shield must be worn when performing the following steps. Failure to follow this warning may result in severe personal injury or death.</b></p> <ul style="list-style-type: none"> <li>• Connect 104-Pin Breakout Box (BOB) to traction battery support tray in-line C1939F and in-line C1939M using Traction Battery Low-Voltage Service Cord.</li> <li>• With key OFF, disconnect BCM C1987 and measure the resistance of the Y wire between pin 18 on BCM C1987 and BOB pin 52.</li> <li>• <b>Is the resistance less than 5 ohms?</b></li> </ul>	<p>No = REPAIR the Y wire.</p>
<p><b>Q4 CHECK FOR INTERMITTENT CONCERN(S)</b></p> <ul style="list-style-type: none"> <li>• With key OFF, reconnect DTR sensor C4996 and BCM C1987.</li> <li>• Perform the on-demand self-test for the BCM.</li> <li>• <b>Does DTC C1861 PRNDL Input #4 Circuit Failure occur?</b></li> </ul>	<p>Yes = REPLACE the BCM. No = System OK. CHECK wiring for intermittent connections.</p>

**PINPOINT TEST R: DTC C1863 EXTERNAL CHARGING FAULT**

TEST STEP	ACTION TO TAKE
<p><b>R1 CHECK CHARGER CORD INPUT STATUS</b></p> <p><b>NOTE:</b> Verify the power control station (PCS) charger cord is not plugged into the charger inlet before performing this test step.</p> <ul style="list-style-type: none"> <li>• With key ON, monitor BCM PID CHGCORD.</li> <li>• <b>Does the CHGCORD PID indicate IN?</b></li> </ul>	<p>Yes = GO to <b>R2</b>. No = System OK. CHECK wiring for intermittent connections.</p>
<p><b>R2 CHECK CHARGER INLET CONNECTOR</b></p> <ul style="list-style-type: none"> <li>• With key OFF, disconnect in-line C1969 (located on the chassis next to the right headlamp inside the underhood compartment).</li> <li>• With key ON, monitor BCM PID CHGCORD.</li> <li>• <b>Does the CHGCORD PID indicate IN?</b></li> </ul>	<p>Yes = GO to <b>R3</b>. No = REPLACE the charger inlet assembly.</p>
<p><b>R3 CHECK CHARGER CORD INPUT STATUS CIRCUIT FOR SHORT TO GROUND</b></p> <ul style="list-style-type: none"> <li>• With key OFF, measure the resistance between the Y wire on in-line C1969M and ground.</li> <li>• <b>Is the resistance greater than 10,000 ohms?</b></li> </ul>	<p>Yes = REPLACE the BCM. No = GO to <b>R4</b>.</p>
<p><b>R4 CHECK TRACTION INVERTER MODULE (TIM) FOR SHORT TO GROUND</b></p> <ul style="list-style-type: none"> <li>• With key OFF, disconnect TIM C4998 and measure the resistance between the Y wire on in-line C1969M and ground.</li> <li>• <b>Is the resistance greater than 10,000 ohms?</b></li> </ul>	<p>Yes = REPLACE the TIM. REFER to Section 303-14. No = GO to <b>R5</b>.</p>
<p><b>R5 CHECK CIRCUIT 3404 (Y) (OUTSIDE TRACTION BATTERY SUPPORT TRAY) FOR SHORT TO GROUND</b></p> <ul style="list-style-type: none"> <li>• With key OFF, disconnect in-line C1939 on the traction battery support tray and measure the resistance between the Y wire on in-line C1969M and ground.</li> <li>• <b>Is the resistance greater than 10,000 ohms?</b></li> </ul>	<p>Yes = GO to <b>R6</b>. No = REPAIR the Y wire (outside the traction battery support tray).</p>
<p><b>R6 CHECK CIRCUIT 3404 (Y) (INSIDE TRACTION BATTERY SUPPORT TRAY) FOR SHORT TO GROUND</b></p>	

(Continued)

**DIAGNOSIS AND TESTING (Continued)****PINPOINT TEST R: DTC C1863 EXTERNAL CHARGING FAULT**

TEST STEP	ACTION TO TAKE
<ul style="list-style-type: none"> <li>Remove the traction battery and connect Traction Battery High-Voltage Lockout and Diagnostic Tool to the traction battery high-voltage two-pin C3994M.</li> <li>Connect 104-Pin Breakout Box (BOB) to traction battery support tray in-line C1939F using Traction Battery Low-Voltage Service Cord; do not connect Traction Battery Low-Voltage Service Cord to in-line C1939M.</li> </ul> <p><b>⚠ WARNING: The traction battery contains high-voltage components and wiring. High-voltage insulated safety gloves and face shield must be worn when performing the following steps. Failure to follow this warning may result in severe personal injury or death.</b></p> <ul style="list-style-type: none"> <li>With key OFF, disconnect BCM C1987 and measure the resistance between BOB pin 54 and ground (BOB pin 65).</li> <li><b>Is the resistance greater than 10,000 ohms?</b></li> </ul>	<p>Yes = REPLACE the BCM.</p> <p>No = REPAIR the Y wire (inside the traction battery support tray).</p>

**PINPOINT TEST S: DTC B2247 ELECTRIC VEHICLE BATTERY PACK TEMPERATURE FAULT**

TEST STEP	ACTION TO TAKE
<p><b>S1 CHECK STATUS OF BATTERY PACK TEMPERATURE FAULT</b></p> <ul style="list-style-type: none"> <li>With key ON, monitor battery control module (BCM) PIDs HIGHTMP and FAN__DIS.</li> </ul> <p><b>• Do either of the PIDs indicate YES?</b></p>	<p>Yes = If PID HIGHTMP indicates YES, ALLOW vehicle to cool. Monitor BCM PIDs TMPSEN1, TMPSEN2, TMPSEN3, and TMPSEN4 until the temperature difference between all temperature sensors is less than 6°C (43°F).</p> <p>If PID FAN__DIS indicates YES, ALLOW vehicle to cool. Monitor BCM PIDs TMPSEN1, TMPSEN2, TMPSEN3, and TMPSEN4 until all temperature sensors are less than 70°C (158°F).</p> <p>No = System OK.</p>

**PINPOINT TEST T: POWER CONTROL STATION (PCS) OPERATION VERIFICATION TEST**

TEST STEP	ACTION TO TAKE
<p><b>T1 CHECK POWER CONTROL STATION (PCS) SERVICE LIGHT</b></p> <p><b>NOTE:</b> If turning the power on and off or unplugging and plugging the PCS from the charger inlet connector does not cause any of the lights on the PCS to illuminate, the PCS has either failed or has a damaged cord. Call the manufacturer for repair or replacement.</p> <ul style="list-style-type: none"> <li>Verify the PCS is properly inserted into the vehicle's charger inlet connector and locked in place.</li> <li>Check the Protection light (EVI manufacturer) or the Charge Interrupted light (SCI manufacturer) on the PCS.</li> <li><b>Is the Protection light (EVI manufacturer) or the Charge Interrupted light (SCI manufacturer) illuminated?</b></li> </ul>	<p>Yes = GO to T2.</p> <p>No = GO to T3.</p>
<p><b>T2 CLEAR THE FAULT AND RECHECK</b></p>	

(Continued)



**DIAGNOSIS AND TESTING (Continued)****Traction Battery Cooling/Ventilation System****Diagnostic Trouble Code (DTC) Definition**

The following DTC relates to the traction battery cooling/ventilation system:

- DTC B2513 Blower (Fan) Circuit Failure
  - The traction battery support tray contains a blower fan for cooling and ventilation that is enabled and disabled by the battery control module (BCM). The BCM sets DTC B2513 if it does not receive a fan feedback signal when the blower fan is enabled during cooling or ventilation mode.

**Electrical Schematic**

Refer to Electrical and Vacuum Troubleshooting Manual, Cell 19, Traction Battery Cooling/Ventilation for schematic and connector information.

**Inspection and Verification**

Refer to [Section 100-07](#).

**Symptom Chart****Symptom Chart**

Condition	Possible Sources	Action
<ul style="list-style-type: none"> <li>• DTC B2513 Blower (Fan) Circuit Failure</li> </ul>	<ul style="list-style-type: none"> <li>• Fuse.</li> <li>• Circuit(s).</li> <li>• Traction battery cooling fan relay.</li> <li>• Traction battery cooling fan.</li> <li>• Battery control module (BCM).</li> </ul>	<ul style="list-style-type: none"> <li>• GO to Pinpoint Test A.</li> </ul>

**Pinpoint Tests****Special Tool(s)**

104-Pin Breakout Box (BOB) 418-049 (014-00950) or equivalent
BCM/TIM Breakout Box (BOB) Adapter Cable 418-F212
BCM/TIM Breakout Box (BOB) Overlay 418-F220

(Continued)

**Special Tool(s)**

Traction Battery High-Voltage Service Cord 418-F218
Traction Battery Low-Voltage Service Cord 418-F219
Traction Battery High-Voltage Lockout and Diagnostic Tool 418-F207
High-Voltage Insulated Safety Gloves 100-F036 or equivalent
Face Shield 100-F035 or equivalent

**PINPOINT TEST A: DTC B2513 BLOWER (FAN) CIRCUIT FAILURE**

TEST STEP	ACTION TO TAKE
<b>A1 CHECK TRACTION BATTERY COOLING FAN OPERATION</b>  <b>NOTE:</b> If battery control module (BCM) DTC B2513 occurs in continuous memory but not during on-demand self test and the traction battery cooling fan runs continuously at high speed, GO to <b>A15</b> . <ul style="list-style-type: none"> <li>• Enter BCM active command mode FAN SPEED CONTROL and set active command FAN SPEED to 100%.</li> <li>• <b>Does the traction battery cooling fan operate?</b></li> </ul>	Yes = GO to <b>A3</b> .  No = GO to <b>A2</b> .
<b>A2 CHECK FAN POWER STATUS</b>	

(Continued)

**DIAGNOSIS AND TESTING (Continued)****PINPOINT TEST A: DTC B2513 BLOWER (FAN) CIRCUIT FAILURE**

TEST STEP	ACTION TO TAKE
<p><b>NOTE:</b> If an emergency power off (EPO) condition occurs, the fan power will be disabled. If interface adapter assembly (IAA) module DTC B2517 Emergency Power Off System Faulted occurred, perform the appropriate diagnostic procedures before performing this test step. Refer to the IAA Module DTC Index in Section 100-07.</p> <ul style="list-style-type: none"> <li>With key ON, monitor BCM PID FAN_PWR.</li> <li><b>Does the FAN_PWR PID indicate ENABLE?</b></li> </ul>	<p>Yes = GO to <b>A3</b>.</p> <p>No = REPLACE the BCM.</p>
<p><b>A3 CHECK FAN FEEDBACK STATUS</b></p> <ul style="list-style-type: none"> <li>Enter BCM active command mode FAN SPEED CONTROL, monitor BCM PID FAN_FB, and set active command FAN SPEED to 50%.</li> <li><b>Does the FAN_FB PID indicate ENABLE?</b></li> </ul>	<p>Yes = System OK. CHECK wiring for intermittent connections.</p> <p>No = If fan operates, GO to <b>A12</b>. If fan does not operate, GO to <b>A4</b>.</p>
<p><b>A4 CHECK FUSE AND POWER TO TRACTION BATTERY COOLING FAN RELAY AT TRACTION BATTERY SUPPORT TRAY</b></p> <ul style="list-style-type: none"> <li>Check 30A fuse 17 in the electric vehicle power distribution box (EVPDB).</li> <li>With key OFF, disconnect traction battery support tray in-line C1939 and connect 104-Pin Breakout Box (BOB) to in-line C1939M using Traction Battery Low-Voltage Service Cord; do not connect Traction Battery Low-Voltage Service Cord to in-line C1939F.</li> <li>With key OFF, measure the voltage between BOB pin 64 and ground (BOB pin 65). (V &gt; 10 volts)</li> <li><b>Is everything OK?</b></li> </ul>	<p>Yes = GO to <b>A5</b>.</p> <p>No = REPAIR as necessary.</p>
<p><b>A5 CHECK POWER TO TRACTION BATTERY COOLING FAN</b></p> <ul style="list-style-type: none"> <li>Disconnect BOB from in-line C1939M, remove the traction battery, and connect Traction Battery High-Voltage Lockout and Diagnostic Tool to the traction battery high-voltage two-pin C3994M.</li> </ul> <p><b>⚠ WARNING: The traction battery contains high-voltage components and wiring. High-voltage insulated safety gloves and face shield must be worn when performing the following steps. Failure to follow this warning may result in severe personal injury or death.</b></p> <ul style="list-style-type: none"> <li>Connect Traction Battery High-Voltage Service Cord to traction battery support tray in-line C1935F and in-line C1935M.</li> <li>Connect Traction Battery Low-Voltage Service Cord to traction battery support tray in-line C1939F and in-line C1939M.</li> <li>Connect BOB to BCM C1986, C1987 using the BCM/TIM BOB Adapter Cable and Overlay; leave the BCM disconnected.</li> <li>With key OFF, disconnect traction battery cooling fan C1984.</li> <li>Connect a jumper wire between BOB pin B23 and ground (BOB pin A33).</li> <li>Measure the voltage between pin E (W/R wire) on traction battery cooling fan C1984 and ground.</li> <li><b>Is the voltage greater than 10 volts?</b></li> </ul>	<p>Yes = REMOVE the jumper wire. GO to <b>A9</b>.</p> <p>No = REMOVE the jumper wire. GO to <b>A6</b>.</p>
<p><b>A6 CHECK POWER TO TRACTION BATTERY COOLING FAN RELAY</b></p> <ul style="list-style-type: none"> <li>Disconnect traction battery cooling fan relay C1983 and measure the voltage between pin 86 (Y/BK wire), pin 87 (Y/BK wire) on traction battery cooling fan relay C1983 and ground.</li> <li><b>Are the voltages greater than 10 volts?</b></li> </ul>	<p>Yes = GO to <b>A7</b>.</p> <p>No = REPAIR the Y/BK wire(s).</p>
<p><b>A7 CHECK TRACTION BATTERY COOLING FAN RELAY</b></p> <ul style="list-style-type: none"> <li>Connect 12-volts to pin 86 and ground to pin 85 on the traction battery cooling fan relay.</li> </ul>	<p>Yes = GO to <b>A8</b>.</p>

(Continued)

**DIAGNOSIS AND TESTING (Continued)****PINPOINT TEST A: DTC B2513 BLOWER (FAN) CIRCUIT FAILURE**

TEST STEP	ACTION TO TAKE
<ul style="list-style-type: none"> <li>Measure the resistance between pins 30 and 87 on the traction battery cooling fan relay.</li> <li><b>Is the resistance less than 5 ohms?</b></li> </ul>	No = REPLACE the traction battery cooling fan relay.
<b>A8 CHECK CIRCUITS 3850 (LG/P) AND 3397 (W/R) FOR OPEN(S)</b> <ul style="list-style-type: none"> <li>With key OFF, measure the resistance of the LG/P wire between pin 85 on traction battery cooling fan relay C1983 and BOB pin B23.</li> <li>With key OFF, measure the resistance of the W/R wire between pin 30 on traction battery cooling fan relay C1983 and pin E on traction battery cooling fan C1984.</li> <li><b>Are the resistances less than 5 ohms?</b></li> </ul>	Yes = REPLACE the BCM.  No = REPAIR the wire(s) in question.
<b>A9 CHECK CIRCUIT 3395 (O/LB) FOR OPEN</b> <ul style="list-style-type: none"> <li>With key OFF, measure the resistance of the O/LB wire between pin A on traction battery cooling fan C1984 and BOB pin A32.</li> <li><b>Is the resistance less than 5 ohms?</b></li> </ul>	Yes = GO to A10.  No = REPAIR the O/LB wire.
<b>A10 CHECK CIRCUIT 3395 (O/LB) FOR SHORT TO GROUND</b> <ul style="list-style-type: none"> <li>With key OFF, measure the resistance between BOB pin A32 and ground (BOB pin A33).</li> <li><b>Is the resistance greater than 10,000 ohms?</b></li> </ul>	Yes = GO to A11.  No = REPAIR the O/LB wire.
<b>A11 CHECK BCM CONTROL SIGNAL TO TRACTION BATTERY COOLING FAN</b> <ul style="list-style-type: none"> <li>With key OFF, connect BCM to BOB; leave BOB connected to BCM C1986, C1987.</li> <li>Enter BCM active command mode FAN SPEED CONTROL, set active command FAN SPEED to 50%, and measure the frequency between pin A (O/LB wire) on traction battery cooling fan C1984 and ground.</li> <li><b>Is the frequency greater than 1,800 Hz?</b></li> </ul>	Yes = REPLACE the traction battery cooling fan.  No = REPLACE the BCM.
<b>A12 CHECK FAN FEEDBACK SIGNAL TO BCM</b> <ul style="list-style-type: none"> <li>Remove the traction battery and connect Traction Battery High-Voltage Lockout and Diagnostic Tool to the traction battery high-voltage two-pin C3994M.</li> </ul> <p><b>⚠ WARNING: The traction battery contains high-voltage components and wiring. High-voltage insulated safety gloves and face shield must be worn when performing the following steps. Failure to follow this warning may result in severe personal injury or death.</b></p> <ul style="list-style-type: none"> <li>Connect Traction Battery High-Voltage Service Cord to traction battery support tray in-line C1935F and in-line C1935M.</li> <li>Connect Traction Battery Low-Voltage Service Cord to traction battery support tray in-line C1939F and in-line C1939M.</li> <li>Connect 104-Pin Breakout Box (BOB) to the BCM and BCM C1986, C1987 using the BCM/TIM BOB Adapter Cable and Overlay.</li> <li>Enter BCM active command mode FAN SPEED CONTROL, set active command FAN SPEED to 50%, and measure the frequency between BOB pin A28 and ground (BOB pin A33).</li> <li><b>Is the frequency greater than 50 Hz?</b></li> </ul>	Yes = REPLACE the BCM.  No = GO to A13.
<b>A13 CHECK CIRCUIT 3396 (Y/LG) FOR OPEN</b> <ul style="list-style-type: none"> <li>With key OFF, measure the resistance of the Y/LG wire between pin D on traction battery cooling fan C1984 and BOB pin A28.</li> <li><b>Is the resistance less than 5 ohms?</b></li> </ul>	Yes = GO to A14.  No = REPAIR the Y/LG wire.
<b>A14 CHECK CIRCUIT 3396 (Y/LG) FOR SHORT TO GROUND</b>	

(Continued)

**DIAGNOSIS AND TESTING (Continued)****PINPOINT TEST A: DTC B2513 BLOWER (FAN) CIRCUIT FAILURE**

TEST STEP	ACTION TO TAKE
<ul style="list-style-type: none"> <li>• With key OFF, disconnect BOB from BCM; leave BOB connected to BCM C1986, C1987.</li> <li>• With key OFF, measure the resistance between BOB pin A28 and ground (BOB pin A33).</li> <li>• <b>Is the resistance greater than 10,000 ohms?</b></li> </ul>	Yes = REPLACE the traction battery cooling fan. No = REPAIR the Y/LG wire.
<b>A15 CHECK CIRCUIT 3395 (O/LB) FOR SHORT TO POWER</b> <ul style="list-style-type: none"> <li>• Remove the traction battery and connect Traction Battery High-Voltage Lockout and Diagnostic Tool to the traction battery high-voltage two-pin C3994M.</li> </ul> <p><b>⚠ WARNING: The traction battery contains high-voltage components and wiring. High-voltage insulated safety gloves and face shield must be worn when performing the following steps. Failure to follow this warning may result in severe personal injury or death.</b></p> <ul style="list-style-type: none"> <li>• Connect Traction Battery High-Voltage Service Cord to traction battery support tray in-line C1935F and in-line C1935M.</li> <li>• Connect Traction Battery Low-Voltage Service Cord to traction battery support tray in-line C1939F and in-line C1939M.</li> <li>• Connect 104-Pin Breakout Box (BOB) to BCM C1986, C1987 using the BCM/TIM BOB Adapter Cable and Overlay; leave the BCM disconnected.</li> <li>• With key OFF, disconnect traction battery cooling fan C1984.</li> <li>• With key ON, measure the voltage between BOB pin A32 and ground (BOB pin A33).</li> <li>• <b>Is the voltage greater than 0 volts?</b></li> </ul>	Yes = REPAIR the O/LB wire.  No = REPLACE the BCM.

**Traction Battery System****Battery Module Diagnostic Test**

The Battery Module Diagnostic Test is the method used to analyze electric vehicle traction battery modules. All 39 battery modules are analyzed simultaneously.

## DIAGNOSIS AND TESTING (Continued)

### Battery Module Diagnostic Test

**NOTE:** This is a two-step process. Battery module voltage information must be recorded within five minutes of completing discharge of the traction battery.

**NOTE:** Discharge the traction battery until the Power Limit Light flashes, preferably by driving the vehicle.

- Step 1
- Using the NGS Tester, select the current year and model for the vehicle being serviced.
- Select Diagnostic Data Link.
- Select Battery Control Module.
- Select Active Commands Modes.
- Select Battery Module Select.
- Press #8 SETUP button.
- Select Auto and Hit CANCEL button.
- Press #7 PIDS button and highlight BAT\_MV.
- Hit START button.
- Press TRIGGER and rotate knob to view each battery module. SCROLL through each battery module and record the information.
- Step 2
- Press CANCEL.
- Select Battery Module Select and press ENTER.
- Press the SETUP button and select Auto Send.
- Press CANCEL.
- Press #7 (PIDS) and select BAT\_MC and SOC.
  - Do not select BAT\_SOC.
- Press START.
- Press TRIGGER and SCROLL through the Battery Modules recording the information.
- Contact the National Hotline 1-800-826-4694.

### Diagnostic Trouble Code (DTC) Definition

The following DTCs relate to the traction battery system:

- The traction inverter module (TIM) sets DTC C1755 when the vehicle is shut down for one of four reasons: the temperature protection within the TIM has limited current to zero amps, the battery control module (BCM) sent the TIM a request to limit source current to zero, an overspeed shutdown or due to lack of coolant flow causing a quick rise in temperature within the TIM. If any of these occur, the vehicle shuts down, the malfunction indicator lamp (MIL) illuminates and the power limit warning indicator flashes. The cause of the shutdown is not necessarily due to the TIM. The cooling system loop and traction battery should be checked for faults. The TIM should not be replaced unless the vehicle continues to shut down and no other failures can be detected.
- DTC P1794 Battery Voltage Circuit Malfunction
  - The battery control module (BCM) monitors the 39 individual 8-volt traction battery modules through voltage sense lines. The BCM can sense the battery module voltages if they are within the range of 3 and 14 volts. The BCM sets DTC P1794 if it cannot sense five or more battery module voltages.
- DTC B1671 Battery Module Voltage Out of Range
  - The battery control module (BCM) monitors the 39 individual 8-volt traction battery modules through voltage sense lines. The BCM can sense the battery module voltages if they are within the range of 3 and 14 volts. The BCM sets DTC B1671 if it cannot sense between one and four battery module voltages.
- DTC B1676 Battery Pack Voltage Out of Range
  - The battery control module (BCM) monitors the traction battery voltage through the TB+ and TB- voltage sense lines. The TB+ voltage sense line is connected to battery module 39 and TB- voltage sense line is connected to battery module 1. The BCM sets DTC B1676 if it detects the traction battery voltage to be less than 50 volts or greater than 450 volts. This is usually due to an open or shorted TB+ or TB- voltage sense line.

- DTC C1755 Power Limit Shutdown Fault



**DIAGNOSIS AND TESTING (Continued)**

- DTC C1864 Battery Module Fault

— The battery control module (BCM) monitors the 39 individual 8-volt traction battery modules through voltage sense lines. The BCM sets DTC C1864 if it detects a reverse battery module voltage due to incorrect installation (at initial 12-volt powerup), or if it detects a 12-volt battery module has been installed instead of an 8-volt battery module, or if it detects the wrong hardware (lead acid BCM in a NiMH battery pack) has been installed into the battery pack.

- DTC B2236 Weak or Defective Electric Vehicle Battery Module Fault

— The battery control module (BCM) monitors the 39 individual 8-volt traction battery modules through voltage sense lines. The BCM sets DTC B2236 if it detects a bad battery module during discharge or if it detects any weaker battery modules that are much weaker than the rest at the end of charge.

**Electrical Schematic**

Refer to Electrical and Vacuum Troubleshooting Manual, Cell 16, Traction Battery System for schematic and connector information.

**Inspection and Verification**

Refer to [Section 100-07](#).

**Symptom Chart****Symptom Chart**

Condition	Possible Sources	Action
<ul style="list-style-type: none"> <li>• DTC C1755 Power Limit Shutdown Fault</li> </ul>	<ul style="list-style-type: none"> <li>• Cooling system.</li> <li>• Traction battery fault.</li> <li>• Motor/transaxle.</li> <li>• Traction inverter module (TIM).</li> </ul>	<ul style="list-style-type: none"> <li>• GO to Pinpoint Test A.</li> </ul>
<ul style="list-style-type: none"> <li>• DTC B1671 Battery Module Voltage Out of Range</li> </ul>	<ul style="list-style-type: none"> <li>• Battery module(s).</li> <li>• High-voltage harness (10B694).</li> <li>• High-voltage harness(es) (14A280).</li> <li>• Battery control module (BCM).</li> </ul>	<ul style="list-style-type: none"> <li>• GO to Pinpoint Test B.</li> </ul>
<ul style="list-style-type: none"> <li>• DTC B1676 Battery Pack Voltage Out of Range</li> </ul>	<ul style="list-style-type: none"> <li>• High-voltage harness (10B694).</li> <li>• High-voltage harness(es) (14A280).</li> <li>• Battery control module (BCM).</li> </ul>	<ul style="list-style-type: none"> <li>• GO to Pinpoint Test B.</li> </ul>
<ul style="list-style-type: none"> <li>• DTC P1794 Battery Voltage Circuit Malfunction</li> </ul>	<ul style="list-style-type: none"> <li>• Battery module(s).</li> <li>• High-voltage harness (10B694).</li> <li>• High-voltage harness(es) (14A280).</li> <li>• Battery control module (BCM).</li> </ul>	<ul style="list-style-type: none"> <li>• GO to Pinpoint Test B.</li> </ul>

**DIAGNOSIS AND TESTING (Continued)****Symptom Chart (Continued)**

Condition	Possible Sources	Action
<ul style="list-style-type: none"> <li>DTC C1864 Battery Module Fault</li> </ul>	<ul style="list-style-type: none"> <li>Battery module(s) installed incorrectly (reverse cable polarity).</li> <li>Incorrect battery module (12-volt) installed.</li> <li>Wrong hardware (lead acid BCM in a NiMH battery pack) has been installed in the battery pack.</li> <li>Battery control module (BCM).</li> </ul>	<ul style="list-style-type: none"> <li>GO to Pinpoint Test C.</li> </ul>
<ul style="list-style-type: none"> <li>DTC B2236 Weak or Defective Electric Vehicle Battery Module Fault</li> </ul>	<ul style="list-style-type: none"> <li>Battery module(s).</li> </ul>	<ul style="list-style-type: none"> <li>GO to Pinpoint Test D.</li> </ul>
<ul style="list-style-type: none"> <li>Battery Pack/Module Verification Test</li> </ul>	<ul style="list-style-type: none"> <li>None.</li> </ul>	<ul style="list-style-type: none"> <li>GO to Pinpoint Test E.</li> </ul>

**Pinpoint Tests****Special Tool(s)**

104-Pin Breakout Box (BOB) 418-049 (014-00950) or equivalent
BCM/TIM Breakout Box (BOB) Adapter Cable 418-F212
BCM/TIM Breakout Box (BOB) Overlay 418-F220

(Continued)

**Special Tool(s)**

Traction Battery High-Voltage Service Cord 418-F218
Traction Battery Low-Voltage Service Cord 418-F219
Traction Battery High-Voltage Lockout and Diagnostic Tool 418-F207
High-Voltage Insulated Safety Gloves 100-F036 or equivalent
Face Shield 100-F035 or equivalent

**PINPOINT TEST A: DTC C1755 POWER LIMIT SHUTDOWN FAULT**

TEST STEP	ACTION TO TAKE
<b>A1 CHECK FOR OTHER TRACTION INVERTER MODULE (TIM) DIAGNOSTIC TROUBLE CODES (DTCs)</b>  <b>NOTE:</b> DTCs must be retrieved from the interface adapter assembly (IAA) module before retrieving DTCs from the TIM. If IAA module DTC C1774 Coolant Temperature Sensor Out of Range occurs, refer to Section 303-03 before proceeding. <ul style="list-style-type: none"> <li>Retrieve DTCs from the TIM.</li> <li><b>Does DTC C1854 Motor Temperature Out of Range also occur?</b></li> </ul>	Yes = REFER to Section 303-14.  No = GO to <b>A2</b> .
<b>A2 CHECK BATTERY CONTROL MODULE (BCM) FOR DTCs</b> <ul style="list-style-type: none"> <li>Retrieve DTCs from the BCM.</li> <li><b>Do any BCM DTCs occur?</b></li> </ul>	Yes = REFER to the BCM DTC Index in Section 100-07. No = GO to <b>A3</b> .
<b>A3 CHECK WATER PUMP CIRCUIT</b> <ul style="list-style-type: none"> <li>Disconnect water pump C1998, key ON, measure voltage between the W/R and BK wires.</li> <li><b>Is the voltage above 12Volts?</b></li> </ul>	Yes = Go to <b>A4</b> No = Go to B1 in <a href="#">Section 303-03</a>
<b>A4 CHECK COOLANT FLOW</b>	

(Continued)

**DIAGNOSIS AND TESTING (Continued)****PINPOINT TEST A: DTC C1755 POWER LIMIT SHUTDOWN FAULT**

TEST STEP	ACTION TO TAKE
<ul style="list-style-type: none"> <li>•  <b>WARNING: Make sure the cooling system temperature is not hot. Failure to follow these instructions, may result in personal injury or death.</b> Turn the ignition key ON, remove the radiator cap, and check for coolant flow.</li> <li>• <b>Is there coolant flow?</b></li> </ul>	<p>Yes = Go to <b>A5</b></p> <p>No = Check the cooling system for restrictions. Refer to <a href="#">Section 303-03</a>, Coolant Pump does not operate.</p>
<p><b>A5 MONITOR THE TIM AND TRANSAXLE TEMPERATURE</b></p> <ul style="list-style-type: none"> <li>• Monitor PID TIMTEMP during a road test.</li> <li>• <b>Is the temperature above 80°C (176° F)?</b></li> </ul>	<p>Yes = Check for cooling system restrictions at TIM.</p> <p>No = Intermittant problem in the water pump circuit or the water pump.</p>

**PINPOINT TEST B: BATTERY PACK/MODULE(S) VOLTAGE OUT OF RANGE**

TEST STEP	ACTION TO TAKE
<p><b>B1 CHECK FOR OTHER BATTERY CONTROL MODULE (BCM) DIAGNOSTIC TROUBLE CODES (DTCs)</b></p> <ul style="list-style-type: none"> <li>• Perform the on-demand self-test for the BCM.</li> <li>• <b>Does DTC C1864 Battery Module Fault occur?</b></li> </ul>	<p>Yes = GO to Pinpoint Test C.</p> <p>No = GO to <b>B2</b>.</p> <p>If DTC B1676 Battery Pack Voltage Out of Range occurs, GO to <b>B7</b>.</p>
<p><b>B2 CHECK BATTERY MODULE FAULT STATUS</b></p> <ul style="list-style-type: none"> <li>• With key ON, monitor BCM PIDs BTM__1FT thru BTM39FT.</li> <li>• <b>Do any of the battery module fault PIDs indicate YES?</b></li> </ul>	<p>Yes = GO to <b>B3</b>.</p> <p>No = GO to <b>B6</b>.</p>
<p><b>B3 CHECK VOLTAGE SENSE LINE CIRCUIT BETWEEN BCM AND IN-LINE CONNECTOR FOR OPEN</b></p> <ul style="list-style-type: none"> <li>• Remove the traction battery and connect Traction Battery High-Voltage Lockout and Diagnostic Tool to the traction battery high-voltage two-pin C3994M.</li> </ul> <p> <b>WARNING: The traction battery contains high-voltage components and wiring. High-voltage insulated safety gloves and face shield must be worn when performing the following steps. Failure to follow this warning may result in severe personal injury or death.</b></p> <ul style="list-style-type: none"> <li>• With key OFF, disconnect BCM high-voltage C1865, C1866 and the appropriate in-line connector for the battery module(s) in question.</li> </ul> <p><b>NOTE:</b> If a single battery module fault PID (with the exception of BTM__1FT and BTM39FT) indicates YES, check the battery module in question for reverse cable polarity. Reinstall (correctly) if necessary. If the cable polarity is OK, GO to <b>B6</b>.</p> <ul style="list-style-type: none"> <li>• Measure the resistance of the wire between the BCM high-voltage connector and in-line connector for the indicated battery module fault(s). Use the following information: <b>Battery Module Faults</b></li> </ul>	<p>Yes = GO to <b>B4</b>.</p> <p>No = REPLACE high-voltage harness (10B694). GO to <b>B5</b>.</p>

(Continued)

**DIAGNOSIS AND TESTING (Continued)****PINPOINT TEST B: BATTERY PACK/MODULE(S) VOLTAGE OUT OF RANGE**

TEST STEP	ACTION TO TAKE
<p>—1: circuit 3089 (LB/W) between in-line C1882M (label R) and pin 13 on BCM C1865</p> <p>—1, 2: circuit 3072 (PIK/Y) between in-line C1884M (label A) and pin 19 on BCM C1865</p> <p>—2, 3: circuit 3073 (R/W) between in-line C1876M (label B) and pin 20 on BCM C1865</p> <p>—3, 4: circuit 3074 (BK/O) between in-line C1884M (label A) and pin 21 on BCM C1865</p> <p>—4, 5: circuit 3075 (Y) between in-line C1876M (label B) and pin 15 on BCM C1865</p> <p>—5, 6: circuit 3076 (Y/W) between in-line C1881M (label C) and pin 9 on BCM C1865</p> <p>—6, 7: circuit 3077 (O/LB) between in-line C1880M (label D) and pin 3 on BCM C1865</p> <p>—7, 8: circuit 3078 (LB/O) between in-line C1879M (label G) and pin 4 on BCM C1865</p> <p>—8, 9: circuit 3079 (W/PIK) between in-line C1879M (label G) and pin 10 on BCM C1865</p> <p>—9, 10: circuit 3080 (R/LB) between in-line C1879M (label G) and pin 16 on BCM C1865</p> <p>—10, 11: circuit 3081 (W/R) between in-line C1877M (label H) and pin 22 on BCM C1865</p> <p>—11, 12: circuit 3082 (BK/LG) between in-line C1879M (label G) and pin 23 on BCM C1865</p> <p>—12, 13: circuit 3083 (Y/W) between in-line C1874M (label J) and pin 24 on BCM C1865</p> <p>—13, 14: circuit 3084 (BK/PIK) between in-line C1877M (label H) and pin 18 on BCM C1865</p> <p>—14, 15: circuit 3085 (O/LG) between in-line C1872M (label K) and pin 12 on BCM C1865</p> <p>—15, 16: circuit 3086 (W/P) between in-line C1874M (label J) and pin 6 on BCM C1865</p> <p>—16, 17: circuit 3087 (DG/P) between in-line C1873M (label L) and pin 1 on BCM C1866</p> <p>—17, 18: circuit 3088 (DB/O) between in-line C1869M (label F) and pin 11 on BCM C1866</p> <p>—18, 19: circuit 3090 (P) between in-line C1869M (label F) and pin 21 on BCM C1866</p> <p>—19, 20: circuit 3091 (LB/BK) between in-line C1868M (label M) and pin 31 on BCM C1866</p> <p>—20, 21: circuit 3092 (GY/O) between in-line C1869M (label F) and pin 32 on BCM C1866</p> <p>—21, 22: circuit 3093 (W/LB) between in-line C1868M (label M) and pin 33 on BCM C1866</p> <p>—22, 23: circuit 3094 (LB/R) between in-line C1871M (label E) and pin 23 on BCM C1866</p> <p>—23, 24: circuit 3095 (O/Y) between in-line C1867M (label P) and pin 13 on BCM C1866</p> <p>—24, 25: circuit 3096 (W) between in-line C1870M (label N) and pin 3 on BCM C1866</p> <p>—25, 26: circuit 3097 (R/LG) between in-line C1870M (label N) and pin 4 on BCM C1866</p>	

(Continued)

**DIAGNOSIS AND TESTING (Continued)****PINPOINT TEST B: BATTERY PACK/MODULE(S) VOLTAGE OUT OF RANGE**

TEST STEP	ACTION TO TAKE
<p>—26, 27: circuit 3098 (R/Y) between in-line C1870M (label N) and pin 5 on BCM C1866</p> <p>—27, 28: circuit 3099 (BR) between in-line C1873M (label L) and pin 15 on BCM C1866</p> <p>—28, 29: circuit 3200 (R/BK) between in-line C1875M (label S) and pin 25 on BCM C1866</p> <p>—29, 30: circuit 3201 (LG/BK) between in-line C1875M (label S) and pin 35 on BCM C1866</p> <p>—30, 31: circuit 3202 (T/Y) between in-line C1874M (label J) and pin 36 on BCM C1866</p> <p>—31, 32: circuit 3203 (LG/R) between in-line C1875M (label S) and pin 26 on BCM C1866</p> <p>—32, 33: circuit 3204 (LG/O) between in-line C1878M (label T) and pin 16 on BCM C1866</p> <p>—33, 34: circuit 3205 (O/Y) between in-line C1878M (label T) and pin 6 on BCM C1866</p> <p>—34, 35: circuit 3206 (LG/Y) between in-line C1878M (label T) and pin 7 on BCM C1866</p> <p>—35, 36: circuit 3207 (P/LB) between in-line C1886M (label U) and pin 8 on BCM C1866</p> <p>—36, 37: circuit 3208 (GY/BK) between in-line C1886M (label U) and pin 18 on BCM C1866</p> <p>—37, 38: circuit 3209 (W/BK) between in-line C1886M (label U) and pin 28 on BCM C1866</p> <p>—38, 39: circuit 3210 (LG/W) between in-line C1887M (label V) and pin 38 on BCM C1866</p> <p>—39: circuit 3211 (W/LB) between in-line C1885M (label W) and pin 39 on BCM C1866</p> <p>• <b>Is the resistance less than 5 ohms?</b></p>	
<p><b>B4 CHECK VOLTAGE SENSE LINE CIRCUIT BETWEEN BATTERY MODULE AND IN-LINE CONNECTOR FOR OPEN</b></p> <p>• Measure the resistance between the wire on the in-line connector and battery module post (+ or -) for the indicated battery module fault(s). Use the following information:</p> <p><b>Battery Module Faults</b></p> <p>—1: between circuit 3089 (LB/W) on in-line C1882F (label R) and battery module 1 (-) post</p> <p>—1, 2: between circuit 3072 (PIK/Y) on in-line C1884F (label A) and battery module 1 (+) post</p> <p>—2, 3: between circuit 3073 (R/W) on in-line C1876F (label B) and battery module 2 (+) post</p> <p>—3, 4: between circuit 3074 (BK/O) on in-line C1884F (label A) and battery module 3 (+) post</p> <p>—4, 5: between circuit 3075 (Y) on in-line C1876F (label B) and battery module 4 (+) post</p> <p>—5, 6: between circuit 3076 (Y/W) on in-line C1881F (label C) and battery module 5 (+) post</p> <p>—6, 7: between circuit 3077 (O/LB) on in-line C1880F (label D) and battery module 6 (+) post</p>	<p>Yes = GO to <b>B7</b>.</p> <p>No = REPLACE the harness(es) (14A280) in question. GO to <b>B5</b>.</p>

(Continued)

**DIAGNOSIS AND TESTING (Continued)****PINPOINT TEST B: BATTERY PACK/MODULE(S) VOLTAGE OUT OF RANGE**

TEST STEP	ACTION TO TAKE
<p>—7, 8: between circuit 3078 (LB/O) on in-line C1879F (label G) and battery module 7 (+) post</p> <p>—8, 9: between circuit 3079 (W/PIK) on in-line C1879F (label G) and battery module 8 (+) post</p> <p>—9, 10: between circuit 3080 (R/LB) on in-line C1879F (label G) and battery module 9 (+) post</p> <p>—10, 11: between circuit 3081 (W/R) on in-line C1877F (label H) and battery module 10 (+) post</p> <p>—11, 12: between circuit 3082 (BK/LG) on in-line C1879F (label G) and battery module 11 (+) post</p> <p>—12, 13: between circuit 3083 (Y/W) on in-line C1874F (label J) and battery module 12 (+) post</p> <p>—13, 14: between circuit 3084 (BK/PIK) on in-line C1877F (label H) and battery module 13 (+) post</p> <p>—14, 15: between circuit 3085 (O/LG) on in-line C1872F (label K) and battery module 14 (+) post</p> <p>—15, 16: between circuit 3086 (W/P) on in-line C1874F (label J) and battery module 15 (+) post</p> <p>—16, 17: between circuit 3087 (DG/P) on in-line C1873F (label L) and battery module 16 (+) post</p> <p>—17, 18: between circuit 3088 (DB/O) on in-line C1869F (label F) and battery module 17 (+) post</p> <p>—18, 19: between circuit 3090 (P) on in-line C1869F (label F) and battery module 18 (+) post</p> <p>—19, 20: between circuit 3091 (LB/BK) on in-line C1868F (label M) and battery module 19 (+) post</p> <p>—20, 21: between circuit 3092 (GY/O) on in-line C1869F (label F) and battery module 20 (+) post</p> <p>—21, 22: between circuit 3093 (W/LB) on in-line C1868F (label M) and battery module 21 (+) post</p> <p>—22, 23: between circuit 3094 (LB/R) on in-line C1871F (label E) and battery module 22 (+) post</p> <p>—23, 24: between circuit 3095 (O/Y) on in-line C1867F (label P) and battery module 23 (+) post</p> <p>—24, 25: between circuit 3096 (W) on in-line C1870F (label N) and battery module 24 (+) post</p> <p>—25, 26: between circuit 3097 (R/LG) on in-line C1870F (label N) and battery module 25 (+) post</p> <p>—26, 27: between circuit 3098 (R/Y) on in-line C1870F (label N) and battery module 26 (+) post</p> <p>—27, 28: between circuit 3099 (BR) on in-line C1873F (label L) and battery module 27 (+) post</p> <p>—28, 29: between circuit 3200 (R/BK) on in-line C1875F (label S) and battery module 28 (+) post</p> <p>—29, 30: between circuit 3201 (LG/BK) on in-line C1875F (label S) and battery module 29 (+) post</p> <p>—30, 31: between circuit 3202 (T/Y) on in-line C1874F (label J) and battery module 30 (+) post</p> <p>—31, 32: between circuit 3203 (LG/R) on in-line C1875F (label S) and battery module 31 (+) post</p> <p>—32, 33: between circuit 3204 (LG/O) on in-line C1878F (label T) and battery module 32 (+) post</p>	

(Continued)

**DIAGNOSIS AND TESTING (Continued)****PINPOINT TEST B: BATTERY PACK/MODULE(S) VOLTAGE OUT OF RANGE**

TEST STEP	ACTION TO TAKE
<p>—33, 34: between circuit 3205 (O/Y) on in-line C1878F (label T) and battery module 33 (+) post</p> <p>—34, 35: between circuit 3206 (LG/Y) on in-line C1878F (label T) and battery module 34 (+) post</p> <p>—35, 36: between circuit 3207 (P/LB) on in-line C1886F (label U) and battery module 35 (+) post</p> <p>—36, 37: between circuit 3208 (GY/BK) on in-line C1886F (label U) and battery module 36 (+) post</p> <p>—37, 38: between circuit 3209 (W/BK) on in-line C1886F (label U) and battery module 37 (+) post</p> <p>—38, 39: between circuit 3210 (LG/W) on in-line C1887F (label V) and battery module 38 (+) post</p> <p>—39: between circuit 3211 (W/LB) on in-line C1885F (label W) and battery module 39 (+) post</p> <ul style="list-style-type: none"> <li>• <b>Is the resistance between 28,000 and 34,000 ohms?</b></li> </ul>	
<p><b>B5 CHECK OPEN CIRCUIT VOLTAGE OF BATTERY MODULE</b></p> <ul style="list-style-type: none"> <li>• Measure the voltage of the battery module(s) in question.</li> <li>• <b>Is the voltage less than 7.0 volts?</b></li> </ul>	<p>Yes = GO to <b>B6</b>.</p> <p>No = Battery module OK.</p>
<p><b>B6 INPUT BATTERY MODULE DATA</b></p> <ul style="list-style-type: none"> <li>• Remove the traction battery (if necessary) and connect Traction Battery High-Voltage Lockout and Diagnostic Tool to the traction battery high-voltage two-pin C3994M.</li> <li>• Connect Traction Battery High-Voltage Service Cord to traction battery support tray in-line C1935F and in-line C1935M.</li> </ul> <p> <b>WARNING: The traction battery contains high-voltage components and wiring. High-voltage insulated safety gloves and face shield must be worn when performing the following steps. Failure to follow this warning may result in severe personal injury or death.</b></p> <ul style="list-style-type: none"> <li>• Connect Traction Battery Low-Voltage Service Cord to traction battery support tray in-line C1939F and in-line C1939M.</li> <li>• With key ON, monitor BCM PIDs BAT__INT, BAT__MC, CHG__CYC, and LOWVOLT and enter the values on the Dealer Battery Return Form that is packaged with the new battery module.</li> <li>• Fill out all the required data on the Dealer Battery Return Form and return the form with the damaged battery module.</li> <li>• <b>Is the proper data entered on the Dealer Battery Return Form?</b></li> </ul>	<p>Yes = REPLACE the battery module(s) in question.</p> <p>No = ENTER the indicated data. REPLACE the battery module(s) in question.</p>
<p><b>B7 CHECK TRACTION BATTERY POSITIVE (+) SENSE LINE CIRCUIT 3214 (LB) BETWEEN BCM AND IN-LINE C1885M FOR OPEN</b></p> <ul style="list-style-type: none"> <li>• Remove the traction battery and connect Traction Battery High-Voltage Lockout and Diagnostic Tool to the traction battery high-voltage two-pin C3994M.</li> <li>• Connect Traction Battery High-Voltage Service Cord to traction battery support tray in-line C1935F and in-line C1935M.</li> </ul>	<p>Yes = GO to <b>B8</b>.</p> <p>No = REPLACE high-voltage harness (10B694).</p>

(Continued)

**DIAGNOSIS AND TESTING (Continued)****PINPOINT TEST B: BATTERY PACK/MODULE(S) VOLTAGE OUT OF RANGE**

TEST STEP	ACTION TO TAKE
<p> <b>WARNING: The traction battery contains high-voltage components and wiring. High-voltage insulated safety gloves and face shield must be worn when performing the following steps. Failure to follow this warning may result in severe personal injury or death.</b></p> <ul style="list-style-type: none"> <li>• Connect Traction Battery Low-Voltage Service Cord to traction battery support tray in-line C1939F and in-line C1939M.</li> <li>• With key OFF, disconnect BCM high-voltage C1866.</li> <li>• With key OFF, disconnect in-line C1885 (label W) and measure the resistance of the LB wire between pin 30 on BCM high-voltage C1866 and in-line C1885M.</li> <li>• <b>Is the resistance less than 5 ohms?</b></li> </ul>	
<p><b>B8 CHECK TRACTION BATTERY POSITIVE (+) SENSE LINE CIRCUIT BETWEEN IN-LINE C1885F AND BATTERY MODULE 39 FOR OPEN</b></p> <ul style="list-style-type: none"> <li>• With key OFF, measure the resistance between the LB wire on in-line C1885F and battery module 39 positive (+) post.</li> <li>• <b>Is the resistance between 28,000 and 34,000 ohms?</b></li> </ul>	<p>Yes = GO to <b>B9</b>.</p> <p>No = REPLACE high-voltage harness (14A280-WD).</p>
<p><b>B9 CHECK TRACTION BATTERY NEGATIVE (-) SENSE LINE CIRCUIT 3215 (PK/BK) BETWEEN BCM AND IN-LINE C1882M FOR OPEN</b></p> <ul style="list-style-type: none"> <li>• With key OFF, disconnect BCM high-voltage C1865 and in-line C1882 (label R).</li> <li>• With key OFF, measure the resistance of the PK/BK wire between pin 1 on BCM high-voltage C1865 and in-line C1882M.</li> <li>• <b>Is the resistance less than 5 ohms?</b></li> </ul>	<p>Yes = GO to <b>B10</b>.</p> <p>No = REPLACE high-voltage harness (10B694).</p>
<p><b>B10 CHECK TRACTION BATTERY NEGATIVE (-) SENSE LINE CIRCUIT BETWEEN IN-LINE C1882F AND BATTERY MODULE 1 FOR OPEN</b></p> <ul style="list-style-type: none"> <li>• With key OFF, measure the resistance between the PK/BK wire on in-line C1882F and battery module 1 negative (-) post.</li> <li>• <b>Is the resistance between 28,000 and 34,000 ohms?</b></li> </ul>	<p>Yes = GO to <b>B11</b>.</p> <p>No = REPLACE high-voltage harness (14A280-RF).</p>
<p><b>B11 CHECK FOR INTERMITTENT CONCERN(S)</b></p> <ul style="list-style-type: none"> <li>• With key OFF, reconnect in-line C1885 (label W), in-line C1882 (label R), and BCM high-voltage C1865 and C1866.</li> <li>• Perform the on-demand self-test for the BCM.</li> <li>• <b>Does DTC C1676 Battery Pack Voltage Out of Range occur?</b></li> </ul>	<p>Yes = REPLACE the BCM.</p> <p>No = System OK.</p>

**PINPOINT TEST C: DTC C1864 BATTERY MODULE FAULT**

TEST STEP	ACTION TO TAKE
<p><b>C1 CHECK STATUS OF BATTERY PACK</b></p> <ul style="list-style-type: none"> <li>• With key ON, monitor battery control module (BCM) PIDs REV__BAT, 12V__BAT, and WRG__BCM.</li> <li>• <b>Do any of the PIDs indicate YES?</b></li> </ul>	<p>Yes = If PID REV__BAT indicates YES, GO to <b>C2</b>.</p> <p>If PID 12V__BAT indicates YES, GO to <b>C4</b>.</p> <p>If PID WRG__BCM indicates YES, GO to <b>C6</b>.</p> <p>No = System OK.</p>
<p><b>C2 CHECK BATTERY MODULE FAULT STATUS</b></p>	

(Continued)



**DIAGNOSIS AND TESTING (Continued)****PINPOINT TEST C: DTC C1864 BATTERY MODULE FAULT**

TEST STEP	ACTION TO TAKE
<ul style="list-style-type: none"> <li>With key ON, monitor BCM PIDs BTM__1FT through BTM39FT.</li> </ul> <p><b>• Do any of the battery module faults indicate YES?</b></p>	Yes = REMOVE the traction battery (if necessary) and REINSTALL (correctly) the battery module for the BTM__FT that indicates YES. The battery module has been incorrectly (reverse cable polarity) installed. No = GO to C3.
<p><b>C3 CHECK STATUS OF BATTERY CONTROL MODULE (BCM) OPERATING STATE AFTER POWER RESET</b></p> <ul style="list-style-type: none"> <li>Disconnect the 12-volt auxiliary battery negative cable.</li> <li>Wait 30 seconds.</li> <li>Reconnect the 12-volt auxiliary battery negative cable.</li> <li>With key ON, monitor BCM PID BCM__OP.</li> <li><b>Does the BCM__OP PID indicate 50 (battery module reversed)?</b></li> </ul>	Yes = REPLACE the BCM. No = System OK.
<p><b>C4 CHECK FOR 12-VOLT BATTERY MODULE(S)</b></p> <ul style="list-style-type: none"> <li>Enter BCM active command mode BATTERY MODULE SELECT, monitor BCM PID BAT__MV, set the NGS Setup to AUTO, and dial the active command BATTERY # through all 39 battery modules to determine the 12-volt battery module.</li> </ul> <p><b>• Are any 12-volt battery modules detected?</b></p>	Yes = REMOVE the 12-volt battery module(s) and INSTALL an 8-volt battery module. REFER to Traction Battery Module Removal and Installation procedure in this section. No = GO to C5.
<p><b>C5 CHECK FOR INTERMITTENT CONCERN</b></p> <ul style="list-style-type: none"> <li>With key ON, perform the on-demand self-test for the BCM.</li> <li><b>Does DTC C1864 Battery Module Fault occur?</b></li> </ul>	Yes = REPLACE the BCM. No = System OK.
<p><b>C6 CHECK FOR WRONG BCM INSTALLATION</b></p> <ul style="list-style-type: none"> <li>Verify the BCM and battery pack are lead acid.</li> <li><b>Are the BCM and battery pack lead acid?</b></li> </ul>	Yes = REPLACE the BCM. No = INSTALL the correct BCM.

**PINPOINT TEST D: DTC B2236 WEAK OR DEFECTIVE ELECTRIC VEHICLE BATTERY MODULE FAULT**

TEST STEP	ACTION TO TAKE
<p><b>D1 CHECK STATUS OF WEAK/DEFECTIVE BATTERY MODULE FAULT</b></p> <p><b>NOTE:</b> If DTC B1671 Battery Module Voltage Out of Range occurs along with DTC B2236, do NOT perform this test step. Go to Pinpoint Test B.</p> <ul style="list-style-type: none"> <li>With key ON, monitor BCM PID WKDFBMF.</li> <li><b>Does the WKDFBMF indicate YES?</b></li> </ul>	Yes = PERFORM TSB 00-11-1. No = System OK.

**DIAGNOSIS AND TESTING (Continued)****PINPOINT TEST E: BATTERY PACK/MODULE VERIFICATION TEST**

TEST STEP	ACTION TO TAKE
<p><b>E1 PERFORM THE DIAGNOSTIC PROCESS</b></p> <p><b>NOTE:</b> Verify the power control station (PCS) charger cord is not plugged into the charger inlet before performing this test step.</p> <p><b>NOTE:</b> Disregard traction inverter module (TIM) DTC C1862 Contactor Circuit Failure when performing the Diagnostic Process for this test step. DTC C1862 occurs due to the connection of the Traction Battery High-Voltage Lockout and Diagnostic Tool to the traction battery high-voltage two-pin connector C3994M.</p> <ul style="list-style-type: none"> <li>Perform the Diagnostic Process. Refer to Section 100-07.</li> <li><b>Do any DTCs occur?</b></li> </ul>	<p>Yes = REFER to the appropriate Diagnostic Trouble Code (DTC) Index in Section 100-07.</p> <p>No = GO to <b>E2</b>.</p>
<p><b>E2 CHECK INSTRUMENT CLUSTER INDICATORS</b></p> <ul style="list-style-type: none"> <li>With key ON, check to see if the following instrument cluster indicators are illuminated: <ul style="list-style-type: none"> <li>—Malfunction indicator lamp (MIL)</li> <li>—Power limit warning indicator</li> <li>—Red brake warning indicator</li> <li>—Low state of charge (SOC) indicator</li> <li>—Auxiliary battery indicator</li> <li>—Electrical hazard warning indicator (may or may not illuminate)</li> </ul> </li> <li><b>Do all the instrument cluster indicators listed above illuminate?</b></li> </ul>	<p>Yes = GO to <b>E3</b></p> <p>No = REFER to the Powertrain Diagnostic Routines Index in Section 100-09.</p>
<p><b>E3 CHARGE TRACTION BATTERY TO FULL STATE OF CHARGE (SOC)</b></p> <p><b>NOTE:</b> Clear the continuous diagnostic trouble codes (DTCs) from the battery control module (BCM) before connecting the vehicle to a PCS.</p> <ul style="list-style-type: none"> <li>Disconnect the 12-volt auxiliary battery negative cable.</li> <li>Wait approximately 30 seconds and reconnect the auxiliary battery negative cable.</li> <li>Connect the vehicle to the PCS and press the START button to begin charging.</li> <li>With vehicle on-charge, monitor BCM PID BCM__OP.</li> <li>Note the BCM__OP PID numeric value and refer to the BCM Operating State Index in Section 100-07 to determine the BCM operating state.</li> <li><b>Does the BCM__OP PID indicate any no-charge conditions?</b></li> </ul>	<p>Yes = REFER to Powertrain Diagnostic Routines Index in Section 100-09.</p> <p>No = CHARGE traction battery to full SOC. Test complete.</p>

## Multiple Auxiliary Load Failure Diagnosis

### Electrical Schematic

Refer to Electrical and Vacuum Troubleshooting Manual, Cell 13, Power Distribution (High-Voltage) for schematic and connector information.

## Inspection and Verification

Refer to [Section 100-07](#).

**DIAGNOSIS AND TESTING (Continued)****Symptom Chart****Symptom Chart**

Condition	Possible Sources	Action
<ul style="list-style-type: none"> <li>All High-Voltage Auxiliary Load Systems Do Not Operate</li> </ul>	<ul style="list-style-type: none"> <li>High-voltage harness (14B326).</li> <li>High-voltage power distribution box (HVPDB).</li> <li>Contactor box.</li> </ul>	<ul style="list-style-type: none"> <li>GO to Pinpoint Test A.</li> </ul>

**Pinpoint Tests****Special Tool(s)**

Traction Battery High-Voltage Service Cord 418-F218
---

**PINPOINT TEST A: ALL HIGH-VOLTAGE AUXILIARY LOAD SYSTEMS DO NOT OPERATE**

TEST STEP	ACTION TO TAKE
<p><b>A1 VERIFY ALL HIGH-VOLTAGE AUXILIARY LOAD SYSTEMS DO NOT OPERATE</b></p> <ul style="list-style-type: none"> <li>With key ON, turn the steering wheel. If there is no power assist, the power steering system does not operate.</li> <li>With key ON, measure the voltage of the 12-volt auxiliary battery. The voltage should be greater than 13 volts.</li> <li>With key ON, operate the heater and air conditioner (if equipped).</li> <li><b>Do all the high-voltage auxiliary load systems operate?</b></li> </ul>	<p>Yes = System OK. CHECK wiring for intermittent connections.</p> <p>No = If none of the high-voltage auxiliary load systems operate, GO to A2. If some of the high-voltage auxiliary load systems operate, REFER to the appropriate section(s) for the system(s) in question.</p>
<p><b>A2 CHECK HIGH-VOLTAGE NEGATIVE BUS (OUTSIDE TRACTION BATTERY SUPPORT TRAY) FOR OPEN</b></p> <ul style="list-style-type: none"> <li>With key OFF, disconnect high-voltage auxiliary load in-line C1935 on the traction battery support tray and power steering assembly high-voltage C1895.</li> <li>Measure the resistance between circuit 3141 (W wire) on power steering assembly C1895 and circuit 3133 (W wire) on high-voltage auxiliary load in-line C1935M.</li> <li><b>Is the resistance less than 5 ohms?</b></li> </ul>	<p>Yes = GO to A3.</p> <p>No = REPLACE the high-voltage power distribution box (HVPDB).</p>
<p><b>A3 CHECK HIGH-VOLTAGE NEGATIVE BUS (INSIDE TRACTION BATTERY SUPPORT TRAY) FOR OPEN</b></p> <ul style="list-style-type: none"> <li>Remove the traction battery.</li> </ul>	<p>Yes = REPLACE the contactor box.</p> <p>No = REPLACE high-voltage harness 14B326 between traction battery support tray in-line C1935F and contactor box C3985.</p>

(Continued)

**DIAGNOSIS AND TESTING (Continued)****PINPOINT TEST A: ALL HIGH-VOLTAGE AUXILIARY LOAD SYSTEMS DO NOT OPERATE**

TEST STEP	ACTION TO TAKE
<p><b>⚠ WARNING:</b> The traction battery contains high-voltage components and wiring. High-voltage insulated safety gloves and face shield must be worn when performing the following steps. Failure to follow this warning may result in severe personal injury or death.</p> <ul style="list-style-type: none"> <li>• Connect Traction Battery High-Voltage Service Cord to high-voltage auxiliary load in-line C1935F on the traction battery support tray and in-line C1935M.</li> </ul> <p><b>NOTE:</b> Contactor box C3985 is mounted on the passenger side of the BCM.</p> <ul style="list-style-type: none"> <li>• With key OFF, disconnect contactor box C3985 and measure the voltage between the R wire on contactor box C3985 and chassis ground.</li> <li>• <b>Is the voltage greater than 10 volts?</b></li> </ul>	

**GENERAL PROCEDURES****Module Charging****Special Tool(s)**

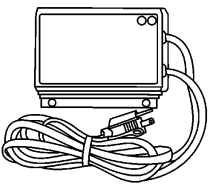
 <p>ST2096-A</p>	<p>8-Volt Battery Charger 418-F214</p>
--	--

1. **⚠ CAUTION:** Do not use any charger other than the recommended 8-Volt Battery Charger.  
Plug the 8-Volt Battery Charger in and ensure that it is turned OFF.
2. Connect the 8-Volt Battery Charger to the module. Connect the RED lead to the positive terminal and the BLACK lead to the negative terminal on the module. Turn the charger on. A red light on the charger will indicate that the charger is operating and that the module is being charged. During the charging cycle, the charger will produce approximately 9.6 volts DC.
3. The steady red light on the charger indicates that the charger is in the charge mode and is working properly. The time that the charger remains in this mode depends on the size and state of charge of the module being charged.

**GENERAL PROCEDURES (Continued)**

4. When the module reaches an 80% state of charge, the green light will start to flash while the red light is steadily lit.
5. When the module reaches 100% state of charge, the red light goes out and the green light will stop flashing and steadily illuminate. The steady green light indicates that the charger has completed charging the module and has entered the maintenance mode.
6. If the green and red lights flash sequentially, the charger to module polarity is incorrect and must be corrected before module charging can begin.

**Traction Battery Module Replacement**

**Special Tool(s)**

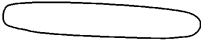
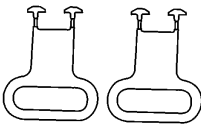
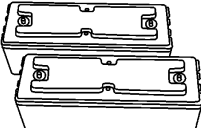
 ST2097-A	Battery Post Torque Wrench 307-026
 ST2091-A	Battery Terminal Cap Opener 418-F215
 ST2095-A	Battery Module Lifting Tool 418-F206
 ST2092-A	In-Line Bypass Battery Module 418-F210

**Special Tool(s)**

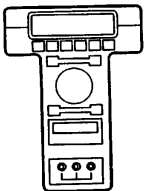
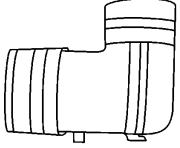
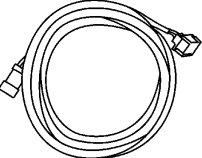
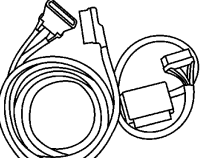
 ST1217-A	New Generation STAR (NGS) Tester or equivalent 418-F048 (007-00500)
 ST2090-A	Traction Battery High-Voltage Lockout and Diagnostic Tool 418-F207
 ST2094-A	Traction Battery High-Voltage Service Cord 418-F218
 ST2093-A	Traction Battery Low-Voltage Service Cord 418-F219

(Continued)

---

**GENERAL PROCEDURES (Continued)****Module Replacement Times**

1. The battery module replacement time for an upper-level battery module is 0.5 hours, not including traction battery removal and charge time.
2. The battery module replacement time for a lower-level battery module is 1.5 hours, not including traction battery removal and charge time.
3. Traction battery charge time can be up to 10 hours for a completely discharged, cold battery. The battery must be charged during battery module replacement.
4. If necessary, charge all new replacement battery modules prior to installation. Refer to [Module Charging](#) to determine battery module charging conditions.
5. **NOTE:** If more than two battery modules need to be replaced, do not replace the traction battery cover or install the traction battery at the end of the procedure. Repeat the battery module removal and installation process until all battery modules have been replaced. Only two battery modules can be replaced at a time, as there are only two In-Line Bypass Battery Modules in the special service tool kit.  
**NOTE:** Position the vehicle near a charging station before beginning the procedure.  
Remove the traction battery. Refer to [Traction Battery](#).
6.  **WARNING: The nominal voltage of the traction battery is 312 volts. The buffer zone must be set up and insulated rubber gloves and a face shield must be worn. Failure to follow these precautions may result in severe personal injury or death.**  
Observe the EV-specific precautions. Refer to [Section 100-00](#).
  - 1 Set up the buffer zone.
  - 2 Test and wear the insulated rubber gloves.
  - 3 Wear the face shield.

## GENERAL PROCEDURES (Continued)

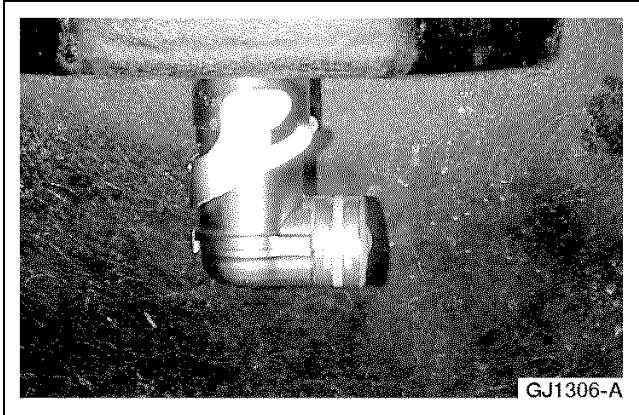

7. **NOTE:** The Traction Battery High-Voltage Lockout and Diagnostic Tool connects to the two-pin high-voltage connector located at the rear of the traction battery.

Install the Traction Battery High-Voltage Lockout and Diagnostic Tool.

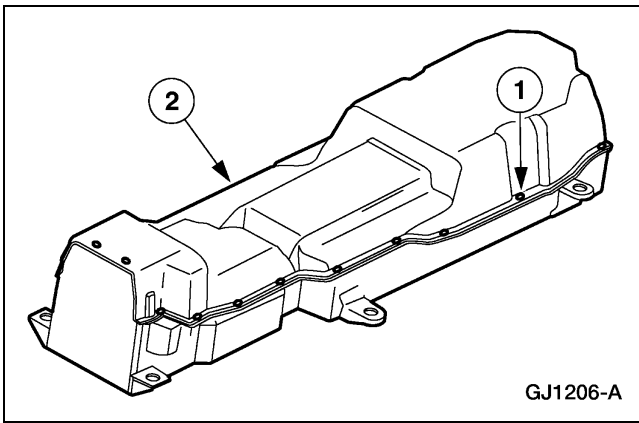

8. Remove the traction battery cover.
- 1 Remove the 22 bolts.
  - 2 Remove the cover.

9. Check the specific battery module number procedure for specific removal information. The battery modules are grouped as follows: 1-7, 17-18, 19-21, 8-11, 34-39, 12-15 and 28-31, 16 and 25-27, and 22-24. Refer to the specific Traction Battery Module procedure.

10. Unclip the necessary connectors from the separator plates above the battery module(s) to be replaced.

11. Remove the separator plates above the battery module(s) to be replaced.

12. Disconnect the HVJs of the battery module(s) to be replaced.

- Remove and discard the two nuts.

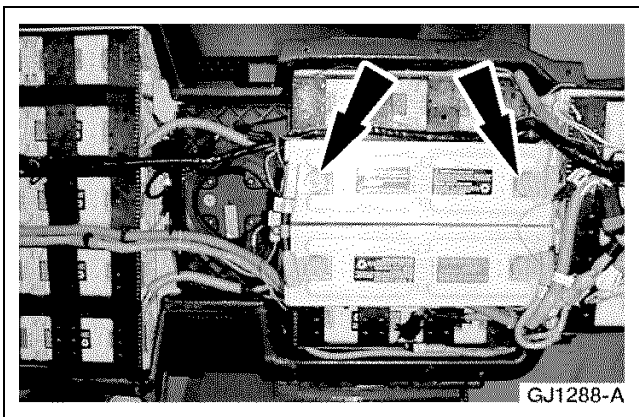

## GENERAL PROCEDURES (Continued)

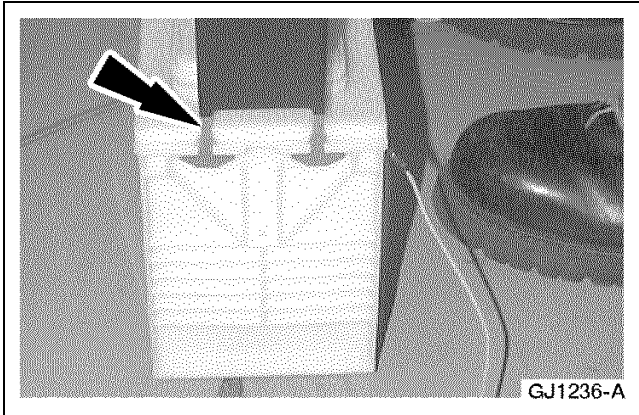

13. For upper-level battery modules, disconnect the heating element connector and the temperature sensor, if equipped.
14. **NOTE:** The tool fits into slots in the side of the battery module.  
Use the Battery Module Lifting Tool to remove the battery module(s).

15. **NOTE:** Do not replace more than 5 battery modules. If more than 5 battery modules need to be replaced, replace all 39 battery modules.  
Enter the indicated data on the Battery Module Replacement Data Form. The form is located on the Electric Ranger Service Card that is inside the traction battery support tray. If more than 5 modules are to be replaced, refer to [Traction Battery Temperature Sensor Disassembly and Assembly](#).

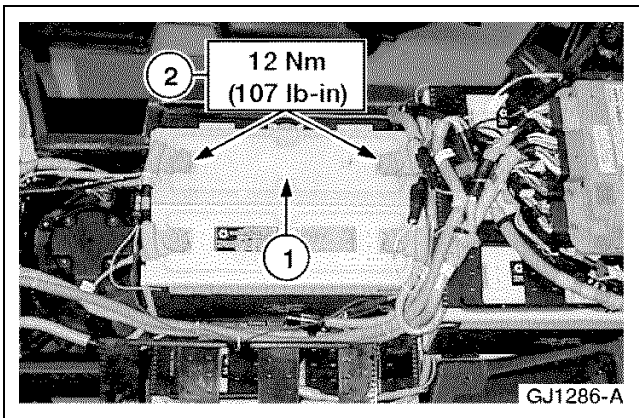

16. **NOTE:** Install a new heating element when installing new battery modules. For additional information, refer to the 2001 Ranger EV Workshop Manual Section 414-03.  
Replace the battery module(s) that were removed with the in-line bypass battery module(s).
  - 1 Position the In-Line Bypass Battery Module.
  - 2 Position the HVJs and tighten the nuts using the Battery Post Torque Wrench.
17. Install the separator plates above the In-Line Bypass Battery Module(s) that were installed.



## GENERAL PROCEDURES (Continued)

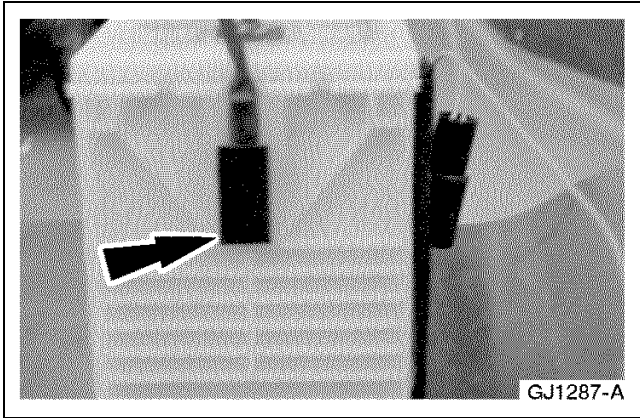

18. Replace any components that were removed to gain access to the battery module(s) that were replaced. The traction battery must be assembled prior to charging. The battery modules are grouped as follows 1-7, 17-18, 19-21, 8-11, 34-39, 12-15 and 28-31, 16 and 25-27, and 22-24. Refer to the specific Traction Battery Module procedure.

19. **⚠ CAUTION: Do not use excessive force to remove the temperature sensor, or damage to the module may occur.**

**NOTE:** If the sensor is difficult to remove, warm it using a heat gun. Be careful not to overheat the sensor or the battery module, or damage to both may occur.

If the battery module that was removed is equipped with a temperature sensor, remove the sensor.

- Pull the bottom of the temperature sensor from the battery module and remove the sensor.

20. Use a heat gun to warm the temperature sensor prior to installation.

21. Apply a thin coat of thermal grease to the back of the thermistor.

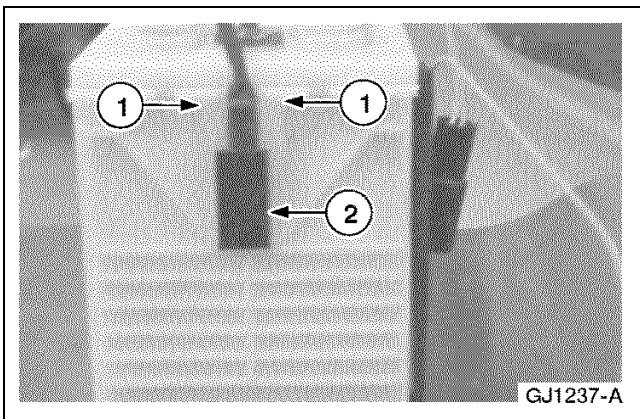

22. **⚠ CAUTION: Do not use excessive force to install the temperature sensor, or damage to the module may occur.**

Install the temperature sensor on the new battery module.

- 1 Position the two prongs on the sensor into the battery module.
- 2 Clip the sensor onto the battery module.

23. Position the removed traction battery next to the vehicle with the 76-pin connector and the auxiliary load high-voltage connector toward the front of the vehicle.

## GENERAL PROCEDURES (Continued)

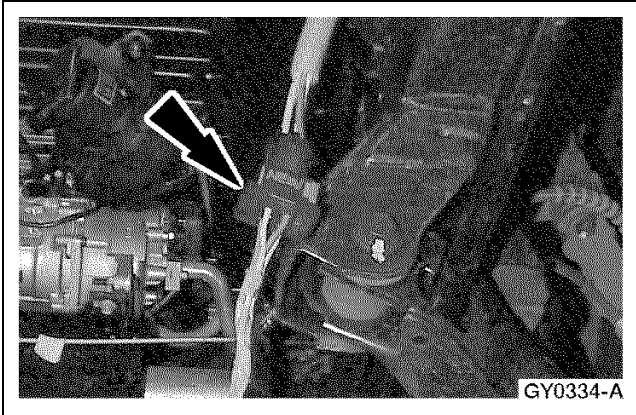

24. Connect the Traction Battery High-Voltage Service Cord to the high-voltage auxiliary load connector on the vehicle.

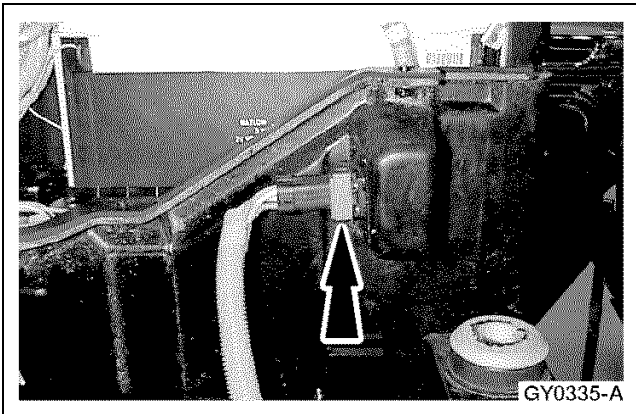

25. Connect the Traction Battery High-Voltage Service Cord to the traction battery high-voltage auxiliary load connector on the traction battery.

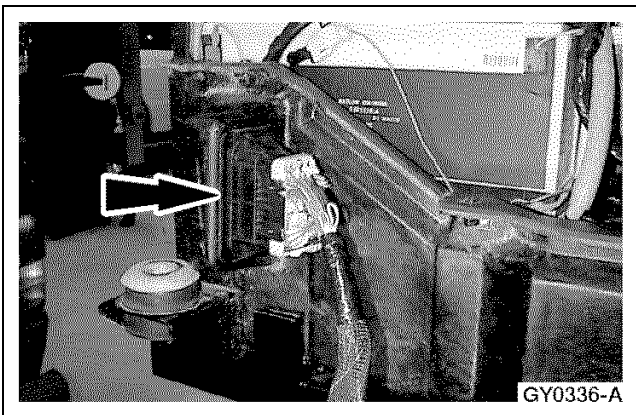

26. Connect the Traction Battery Low-Voltage Service Cord to the 76-pin low-voltage connector on the traction battery.

- Loosely install the bolt.

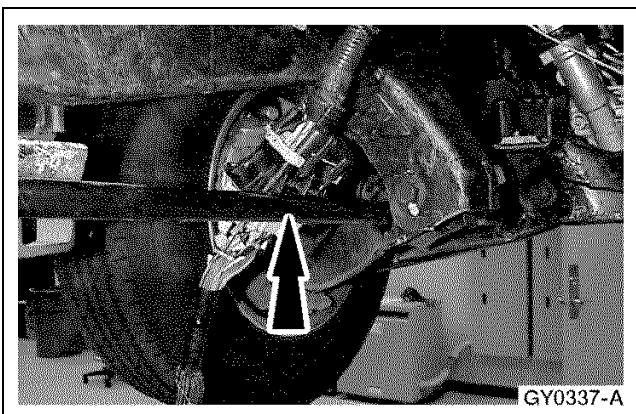

27. Connect the Traction Battery Low-Voltage Service Cord to the 76-pin low-voltage connector on the vehicle.

- Loosely install the bolt.

**GENERAL PROCEDURES (Continued)**

28. Charge the traction battery to a full state of charge (SOC). Refer to [Section 100-05](#).
29. After charging has been completed, press the button to deactivate the power control station (PCS).

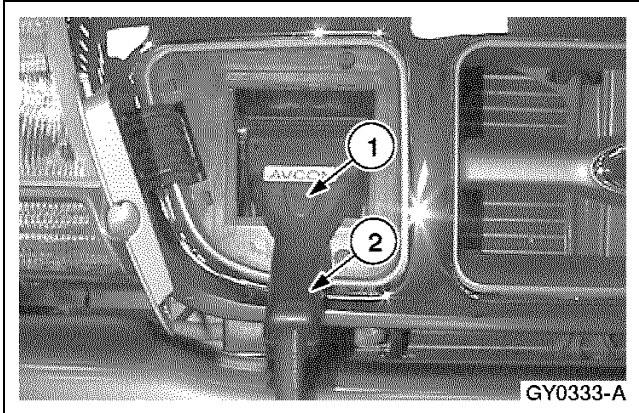

30. **NOTE:** Electric Ranger shown, Postal Ranger EV similar.

Disconnect the PCS from the charger inlet connector.

- 1 Press and hold the release button.
- 2 Lift and disconnect the PCS from the charger inlet connector.

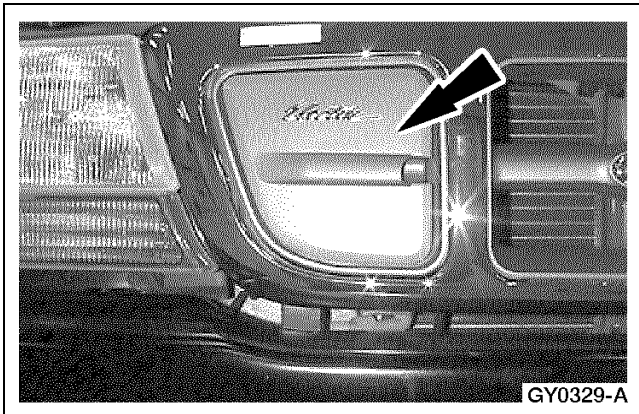

31. **NOTE:** Electric Ranger shown, Postal Ranger EV similar.

Close the charge inlet access door.

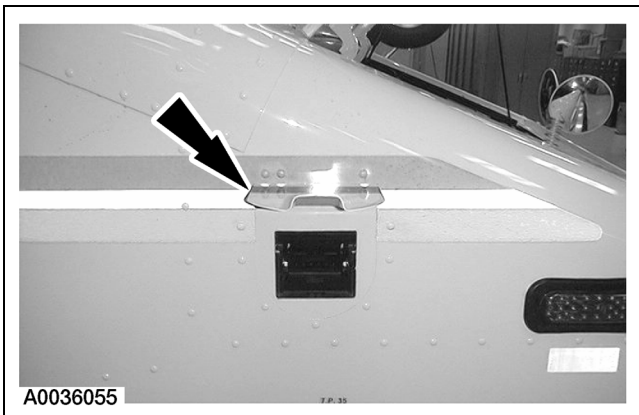

32. **NOTE:** For Postal Ranger EV.  
Close the charge inlet access door.

33. Check the specific battery module number procedure for specific removal information. The battery modules are grouped as follows 1-7, 17-18, 19-21, 8-11, 34-39, 12-15 and 28-31, 16 and 25-27, and 22-24. Refer to the specific Traction Battery Module procedure.

## GENERAL PROCEDURES (Continued)

34. Unclip the necessary connectors from the separator plates above the In-Line Bypass Battery Module(s) to be replaced.
35. Remove the separator plates above the In-Line Bypass Battery Module(s) to be replaced.
36. Disconnect the HVJs from the In-Line Bypass Battery Module(s).

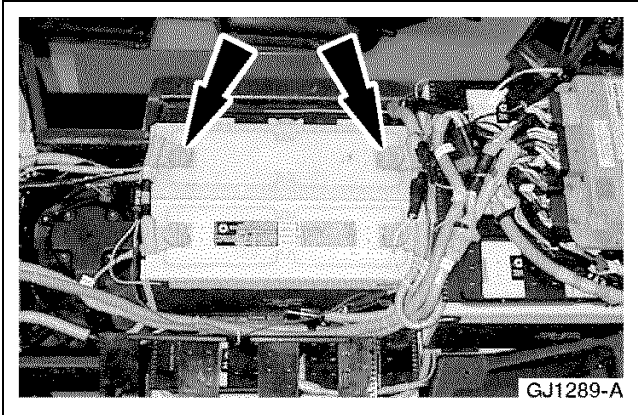

37. Remove the In-Line Bypass Battery Module(s).
38. Install new module number decals on the replacement battery module positive terminal side.

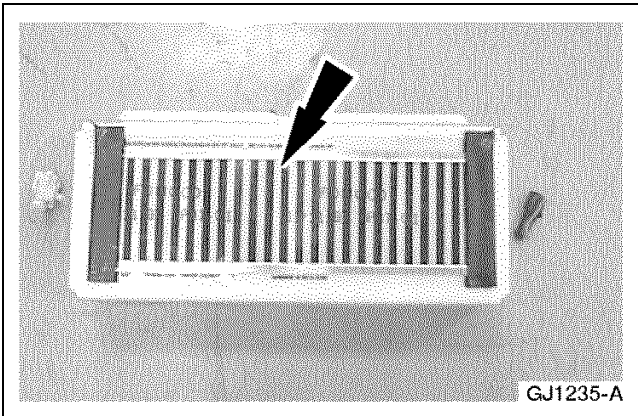

39. **NOTE:** When viewing a heater element, with the adhesive side on the back, the elements with the male electrical connector on the left side are considered LH heater elements. Elements with the male connector on the right side are considered RH elements.

If the module that was replaced was equipped with a heating element, install a new heating element on the new battery module.

- Battery modules 1, 4, 20, and 21 require LH heater elements.
- Battery modules 2, 3, 5, 6, 7, 17, 18, and 19 require RH heater elements.

## GENERAL PROCEDURES (Continued)

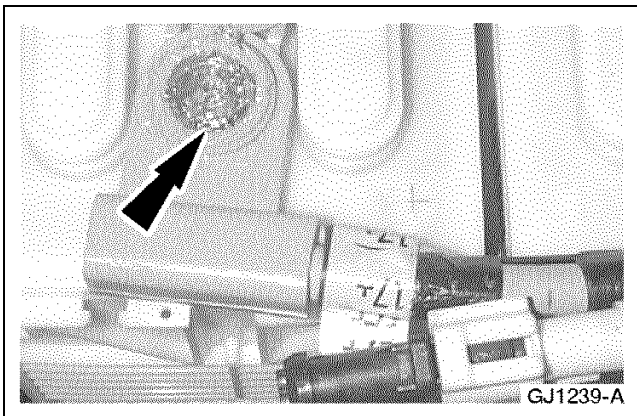
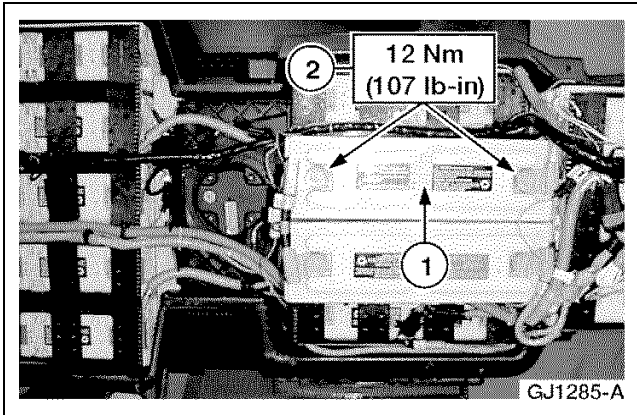

40. Replace the In-Line Bypass Battery Module(s) that were removed with new, charged, traction battery module(s). If necessary, charge the new battery modules prior to installation. Refer to the [Module Charging](#) procedure in this section to determine battery module charging conditions.

- 1 Position the battery module(s).
- 2 Position the HVJs and tighten the nuts using the Battery Post Torque Wrench.

41. Fill the area around the nuts with Nyogel and close the caps.

42. Install the separator plates above the battery module(s) that were installed.

43. Enter the indicated data on the Dealer Battery Return Form that is packaged with the new battery module.

44. Connect New Generation STAR (NGS) Tester to the vehicle.

45. With the key ON, enter battery control module (BCM) active command mode RESET HISTORICAL DATA and set the active command RESET to the battery module(s) that were replaced.

46. Remove the NGS Tester and charge the traction battery to full SOC. Refer to [Section 100-05](#).

47. Perform Battery Pack/Module Verification Test. Refer to Diagnosis and Testing for Traction Battery System in this section.

48. Clip the connectors into the separator plate.

**GENERAL PROCEDURES (Continued)**

49. Install any components that were removed to gain access to the In-Line Bypass Battery Module(s) that were replaced. The battery modules are grouped as follows 1-7, 17-18, 19-21, 8-11, 34-39, 12-15 and 28-31, 16 and 25-27, and 22-24. Refer to the specific Traction Battery Module procedure.

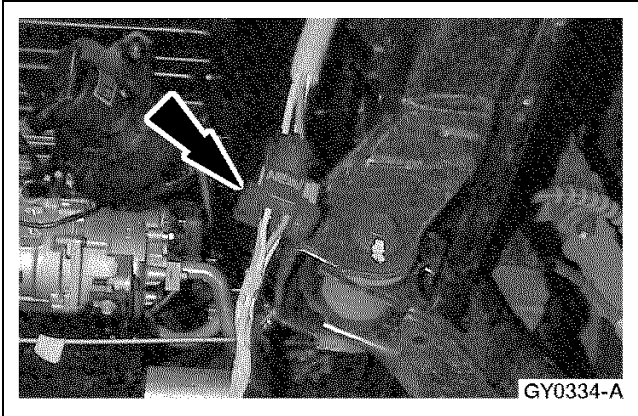

50. Disconnect the Traction Battery High-Voltage Service Cord from the high-voltage auxiliary load connector on the vehicle.

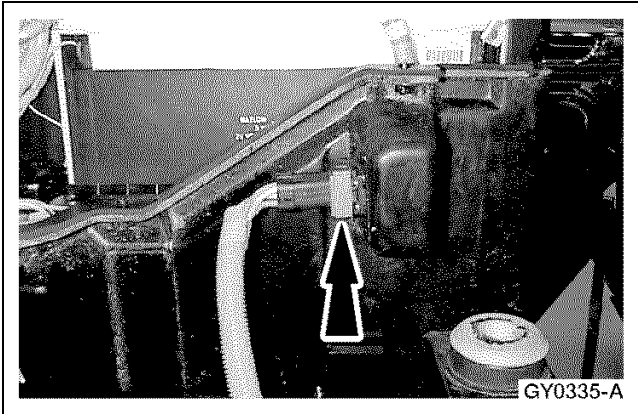

51. Disconnect the Traction Battery High-Voltage Service Cord from the traction battery auxiliary load high-voltage connector on the traction battery.

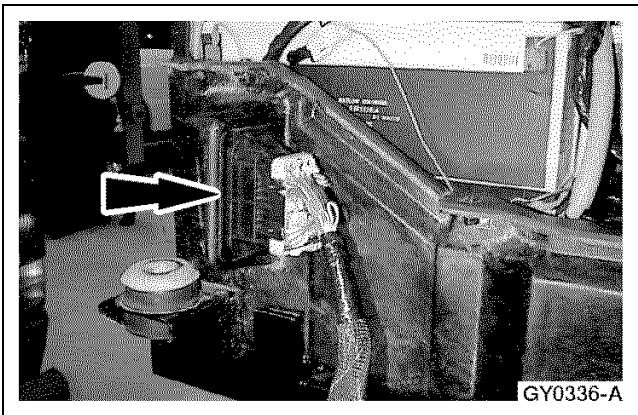

52. Disconnect the Traction Battery Low-Voltage Service Cord from the 76-pin low-voltage connector on the traction battery.

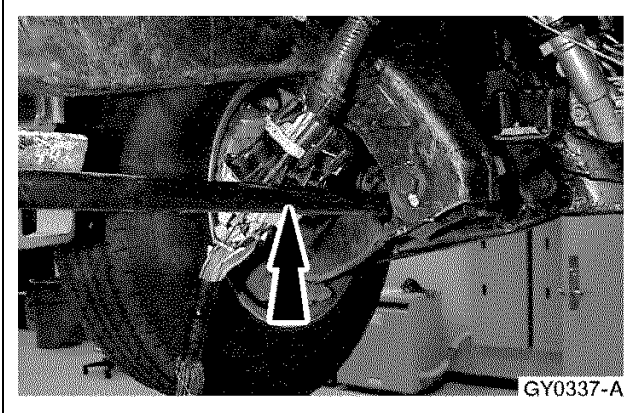
**GENERAL PROCEDURES (Continued)**

53. Disconnect the Traction Battery Low-Voltage Service Cord from the 76-pin low-voltage connector on the vehicle.

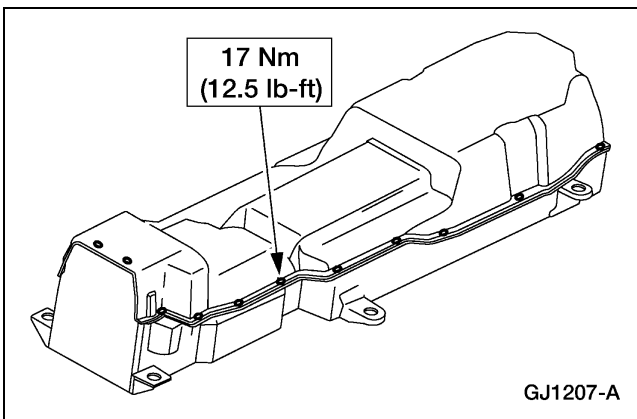

54. Apply Loctite 242 (threadlock and sealer) to the 22 traction battery cover bolts.

55. Install the traction battery cover.
- Install the 22 bolts.

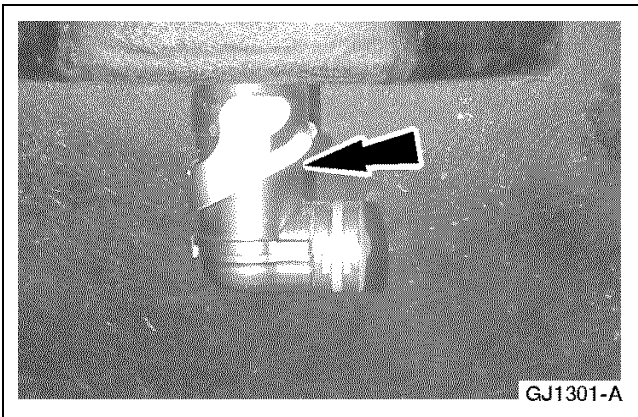



56. Remove the Traction Battery High-Voltage Lockout and Diagnostic Tool.

57. Install the traction battery. Refer to [Traction Battery](#).

GENERAL PROCEDURES (Continued)

Traction Battery Tray Repair

Battery Tray

	Battery locators	1
	Battery tray	2
	Metal brackets	3

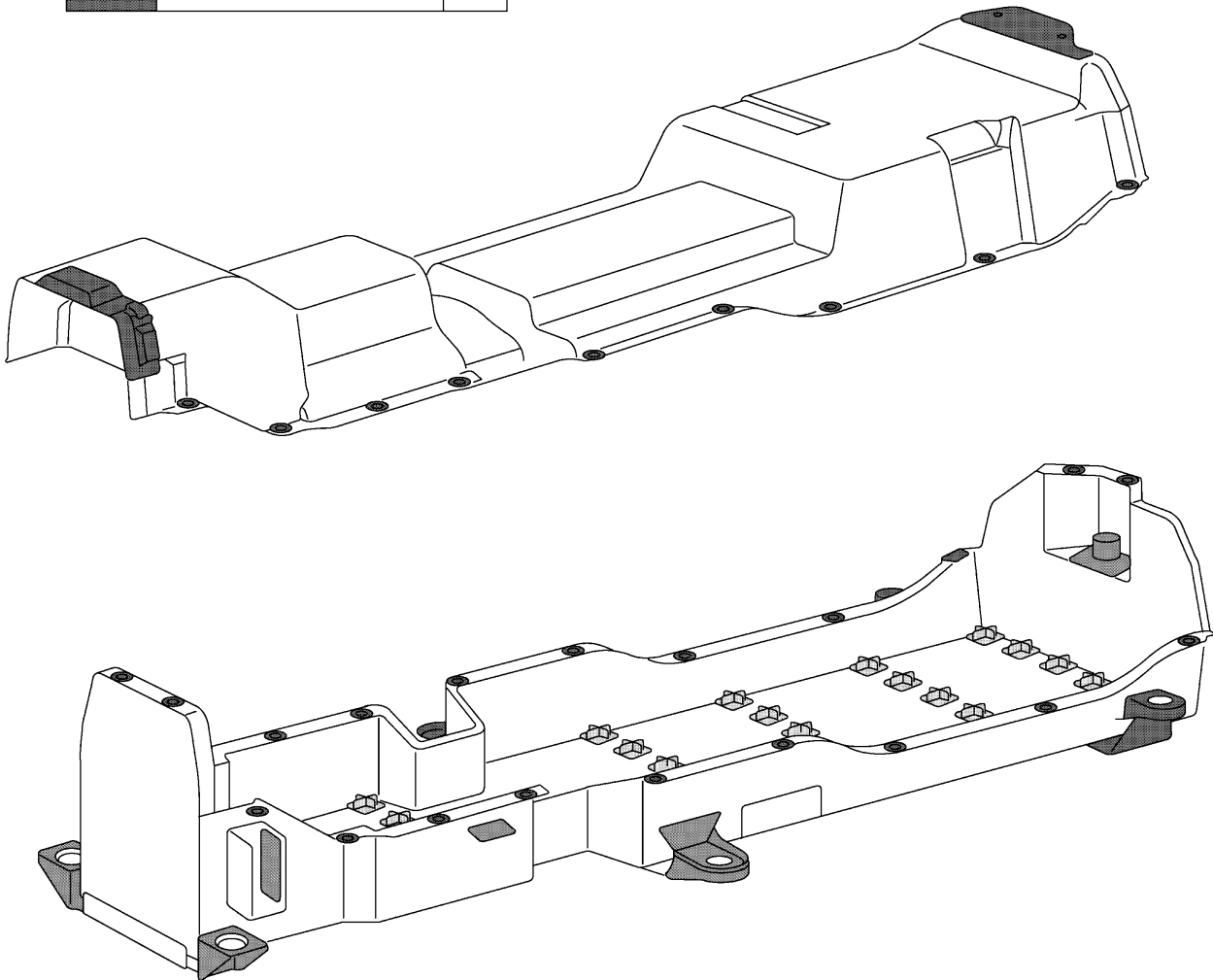

GJ1245-A



## GENERAL PROCEDURES (Continued)

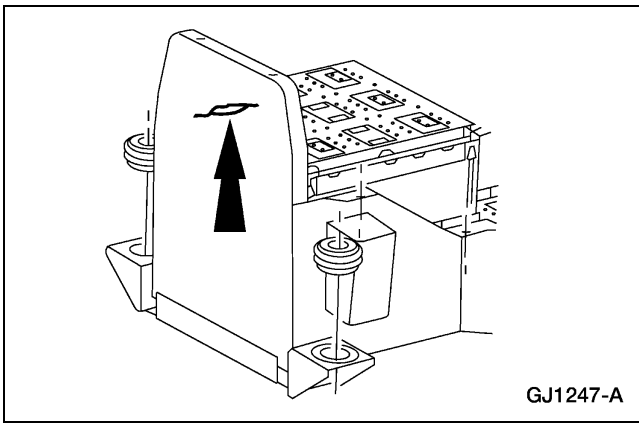
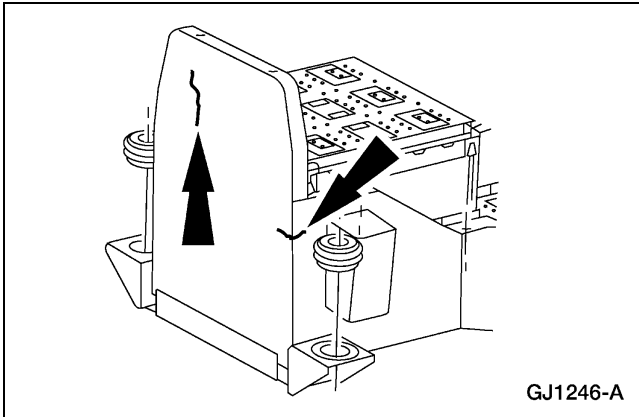

1. **NOTE:** A composite material forms the actual housing of the traction battery. The composite material is a resin transfer molded (RTM) glass-reinforced thermoset plastic with an integral foam core.

A split or scratch on the side or corner of the composite material can be repaired, as long as the damage does not pass all the way through the surface of the composite material.

2. A crack in the composite material less than 25 mm (1 in) in length can also be repaired. A crack is damage that passes all the way through the outer layer of the composite material, exposing the foam core. If the crack is longer than 25 mm (1 in), or the damage passes all the way through the case, the battery case must be replaced.

3. A scratch or split on the surface of the composite material does not need to be repaired and will not affect the performance of the traction battery. If the damage is visible, it can be blended into the surrounding surface by lightly sanding the area.

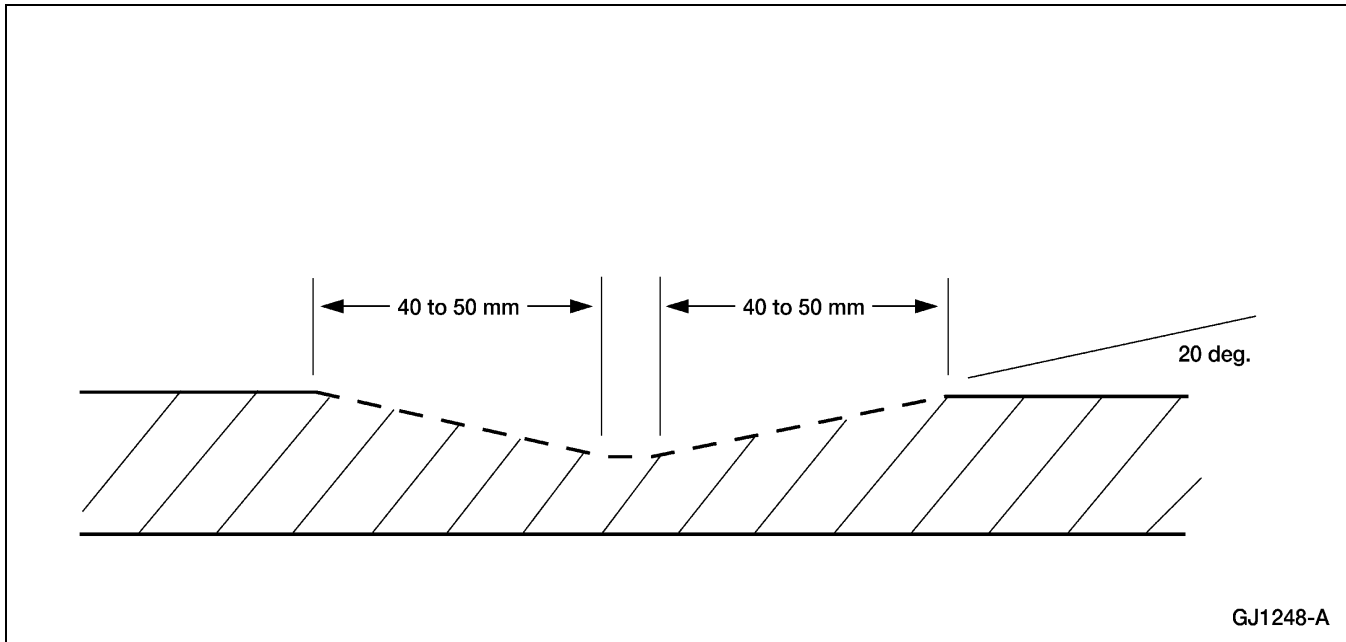
**GENERAL PROCEDURES (Continued)**

4. To repair cracks less than 25 mm (1 in) in length, clean the area surrounding the damage prior to repair. After cleaning, grind a 20 degree bevel extending 40 to 50 mm (1.57 to 2 in) around the damage.

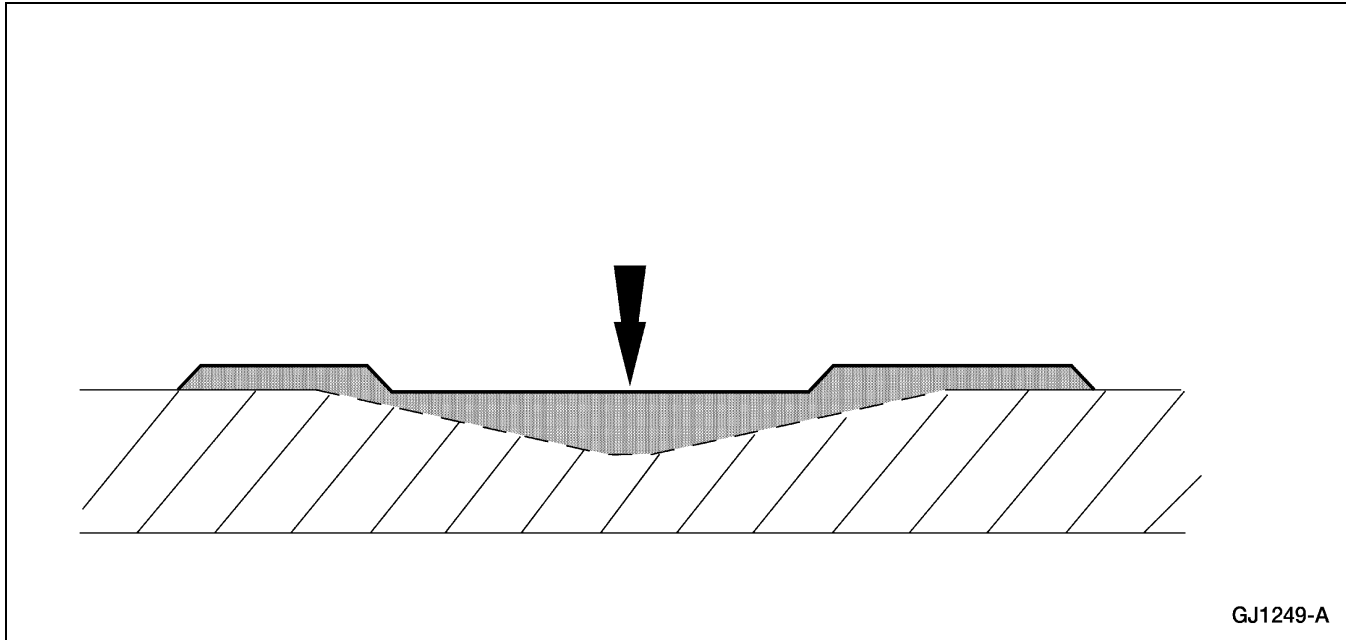
**GENERAL PROCEDURES (Continued)**

5. Immediately after grinding, apply the repair patch. Cut a piece of glass mat that will extend 25 mm (1 in) beyond the damaged area. Prepare a mixture of vinyl ester resin and soak the glass mat in it. Lay the resin soaked glass mat over the damaged area and smooth out the patch using a spreader. The patch should lay on the surface of the composite member as illustrated.
6. Allow the patched area to cure for at least 1.5 to 2 hours at 24°C (75°F). Curing will take longer at colder temperatures. A heat lamp placed no less than 45 cm (18 in) from the repair for approximately 15 minutes will help decrease cure time. After the patch has cured, grind the repair until it is flush with the surrounding area.
7. Cut a piece of glass mat that is 25 mm (1 in) larger than the entire repair area. Prepare a mixture of catalyzed resin and soak the glass mat in it. Lay the resin soaked mat over the patched area and smooth it out with a spreader.

---

**GENERAL PROCEDURES (Continued)**

8. Allow the patched area to cure for at least 1.5 to 2 hours at 24°C (75°F). Curing will take longer at colder temperatures. A heat lamp placed no less than 45 cm (18 in) from the repair for approximately 15 minutes will help decrease cure time. After curing, lightly sand the repaired area to smooth and blend it into the surrounding material.

**Metal Bracket and Battery Locator Replacement**

1. Remove the damaged bracket or locator using a heat gun positioned at least 150 mm (6 in) from the part being removed. The gun will heat the adhesive and allow the part to be removed. Keep the gun moving over the part in order to prevent exposing the composite material to excessive heat. Once the adhesive softens, the part can be removed and discarded.
2. Scrape and sand off all of the remaining adhesive. The surface must be clean and roughly sanded for proper adhesion.
3. Clean the area with alcohol.
4. Prepare a mixture of Pilogrip urethane adhesive and apply it to the bonding area.
5. Position a new bracket or locator. The adhesive should be 1-2 mm (0.04-0.08 in) thick for proper bonding. Do not squeeze out excessive amounts of the adhesive or the bond may fail.
6. Allow the adhesive to cure for 1 hour at 24°C (75°F). After curing, excess adhesive may be trimmed using a sharp knife.

**Battery Tray Seal**

1. The seal surrounds the entire battery tray to prevent moisture in the battery case. Minor splits or gouges within the seal will not affect the performance of the traction battery. Significant rips or tears require replacement of the seal.

**GENERAL PROCEDURES (Continued)**

2. Remove damaged seal by peeling it away from the battery tray.
3. Scrape away any remaining seal pieces stuck to the battery tray.
4. Clean the area with alcohol.
5. Place the new seal on the battery tray by peeling back the white strip to expose the adhesive. Start at one end of the seal to maintain a good fit.
6. Press down continuously along the entire length of the seal to ensure a good bond to the surface of the battery tray.

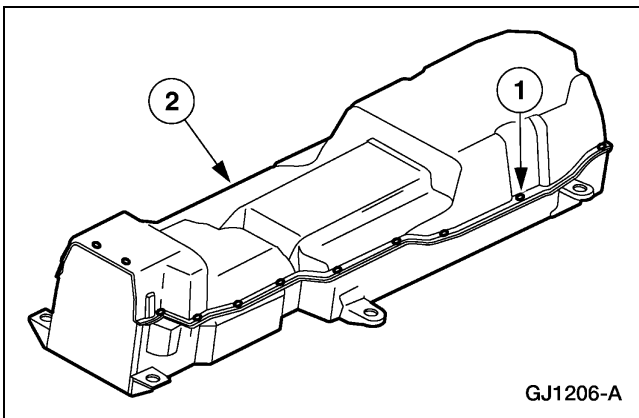
**REMOVAL AND INSTALLATION****Battery Control Module (BCM)****Removal**

1. Remove the traction battery. Refer to [Traction Battery](#).
2. Remove the traction battery cover.
  - 1 Remove the 22 bolts.
  - 2 Remove the cover.

## REMOVAL AND INSTALLATION (Continued)

3.  **WARNING:** The nominal voltage of the traction battery is 312 volts. The buffer zone must be set up and insulated rubber gloves and a face shield must be worn. Failure to follow these precautions may result in severe personal injury or death.

Observe the EV-specific precautions. Refer to [Section 100-00](#).

- 1 Set up the buffer zone.
- 2 Test and wear the insulated rubber gloves.
- 3 Wear the face shield.

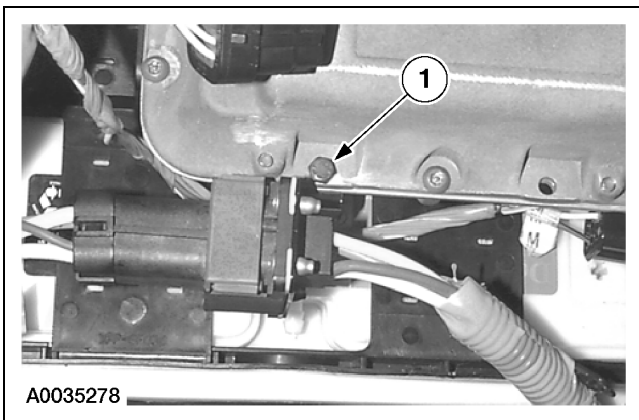

4. Remove the contactor box harness bracket.

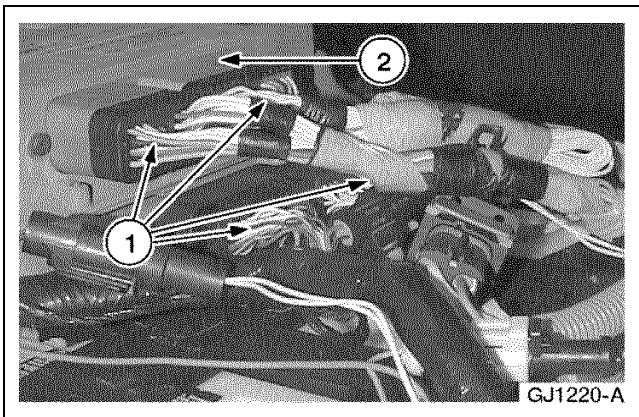

5. **NOTE:** The battery control module (BCM) is held in position with strips of Velcro™.

Remove the BCM.

- 1 Loosen the four bolts and disconnect the four multi-pin connectors from the BCM.
- 2 Remove the BCM.

## REMOVAL AND INSTALLATION (Continued)

### Installation

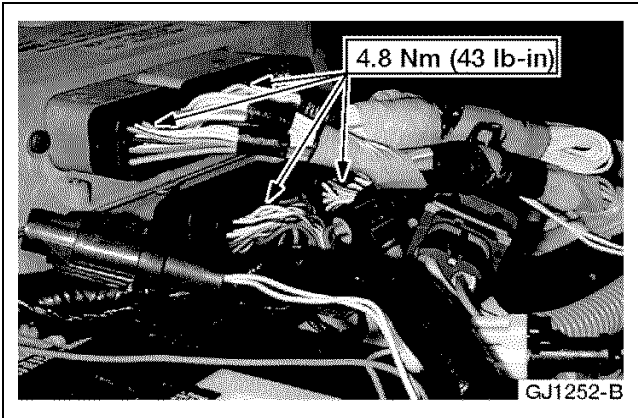

1. **⚠ CAUTION: Do not overtighten the BCM multi-pin connectors. Damage to the connectors may occur if overtightened.**

To install, reverse the removal procedure.

- Fill the area around the high-voltage jumper nuts with Nyogel.
- Apply Loctite 242 to the 22 traction battery cover bolts.
- After installation, connect the New Generation STAR (NGS) Tester. Turn the ignition key ON. Enter the battery control module (BCM) active command mode RESET HISTORICAL DATA and set the active command RESET to ALL.
- Remove the NGS and charge the traction battery. Refer to [Section 100-05](#).

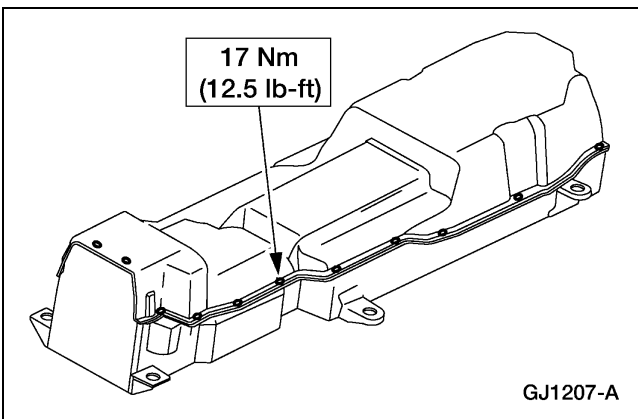
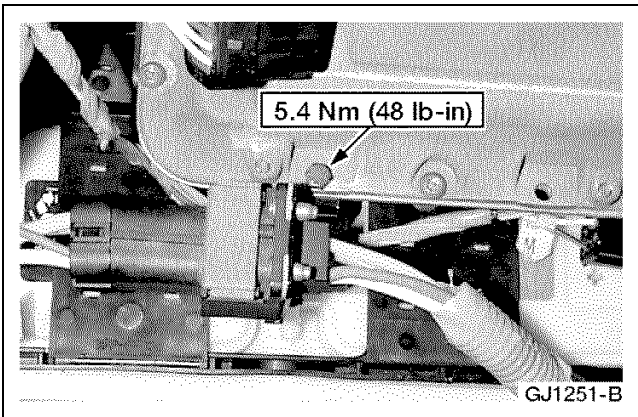

## REMOVAL AND INSTALLATION (Continued)

### Charge Inlet

#### Removal

1. **NOTE:** For Electric Ranger Only.  
Disconnect the traction battery auxiliary load high-voltage connector. Refer to [Section 100-05](#).

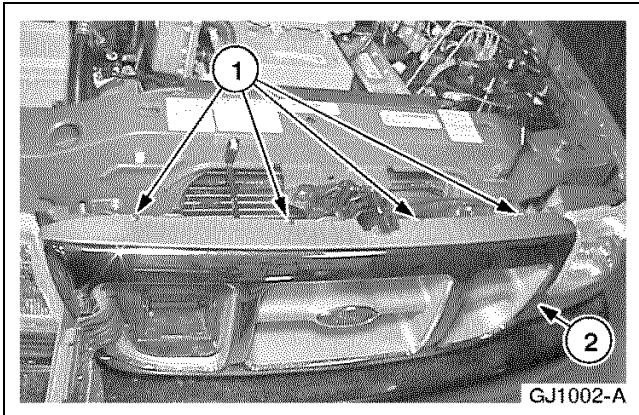

2. Remove the grille.
  - 1 Remove the four screws.
  - 2 Remove the grille.

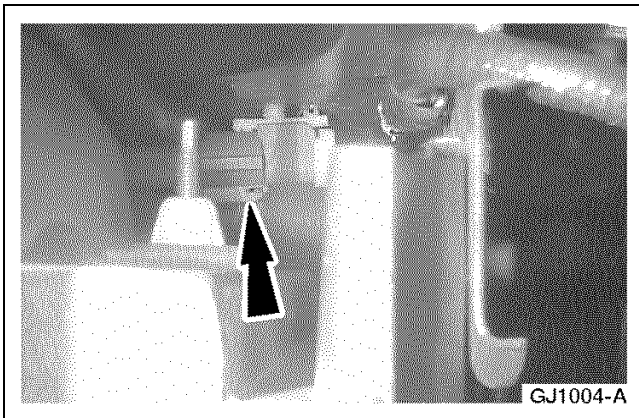

3. **NOTE:** The low-voltage connector is located at the rear of the charger inlet.  
Disconnect the low-voltage electrical connector.

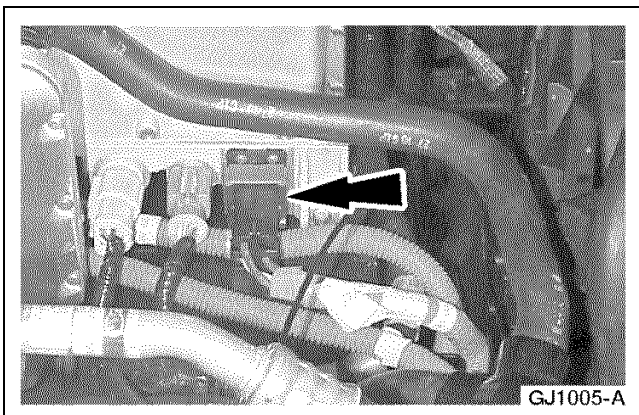

4. Disconnect the traction battery charger high-voltage electrical connector.
  - Unclip the four wiring harness clips.

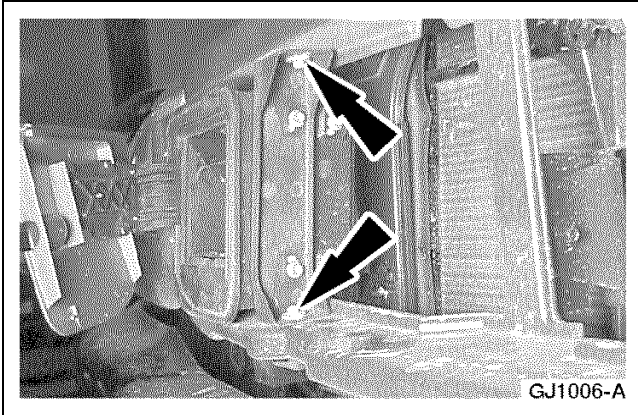

**REMOVAL AND INSTALLATION (Continued)**

5. Remove the two charge bracket bolts.

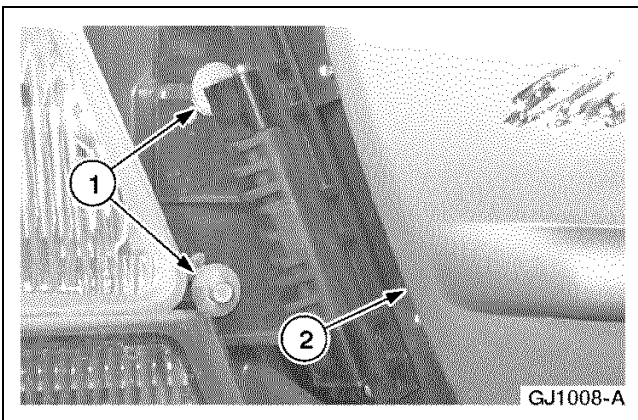

6. Remove the charge inlet.
  - 1 Loosen the two charge inlet bracket bolts.
  - 2 Slide the charge inlet from behind the bolts and remove.

**Installation**

1. To install, reverse the removal procedure.

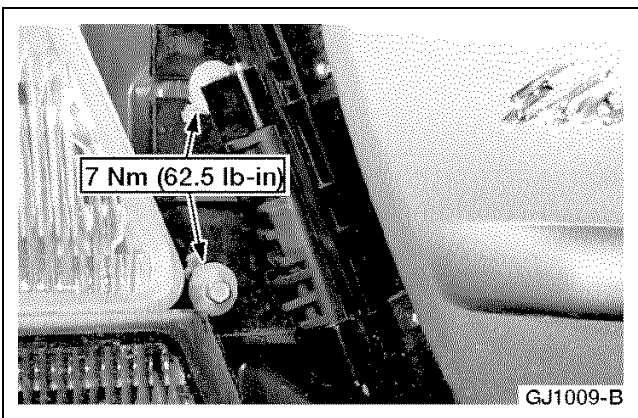

## REMOVAL AND INSTALLATION (Continued)

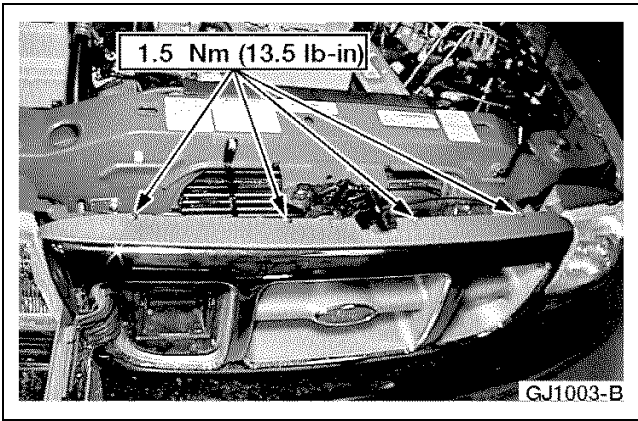
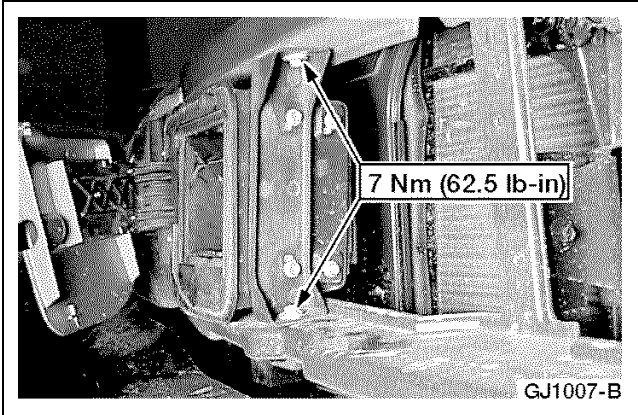

## Contactor Box

### Special Tool(s)

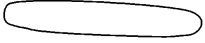
 <p>ST2091-A</p>	<p>Battery Terminal Cap Opener 418-F215</p>
---	---

## Removal

1. Remove the traction battery. Refer to [Traction Battery](#).

## REMOVAL AND INSTALLATION (Continued)

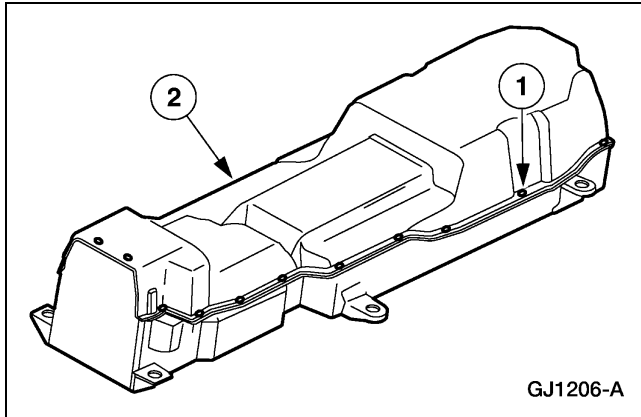

2. Remove the traction battery cover.
  - 1 Remove the 22 bolts.
  - 2 Remove the cover.

3. **⚠ WARNING: The nominal voltage of the traction battery is 312 volts. The buffer zone must be set up and insulated rubber gloves and a face shield must be worn. Failure to follow these precautions may result in severe personal injury or death.**

Observe the EV-specific precautions. Refer to [Section 100-00](#).

- 1 Set up the buffer zone.
- 2 Test and wear the insulated rubber gloves.
- 3 Wear the face shield.

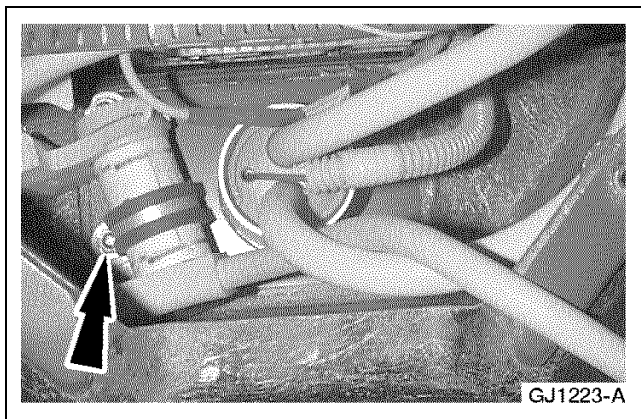

4. Remove the fuse nut.

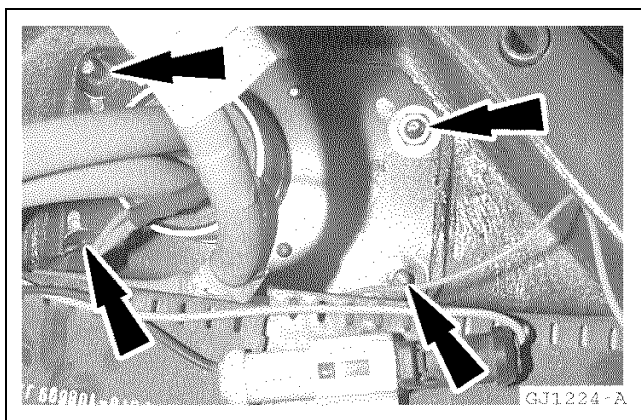

5. Remove the four two-pin high-voltage connector nuts.

## REMOVAL AND INSTALLATION (Continued)

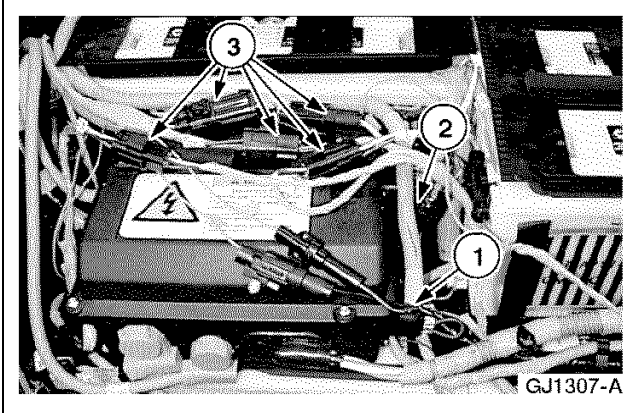

6. Disconnect the contactor box.
  - 1 Disconnect the heating element harness.
  - 2 Disconnect the low-voltage harness from the contactor box.
  - 3 Pull the connectors off the contactor box.

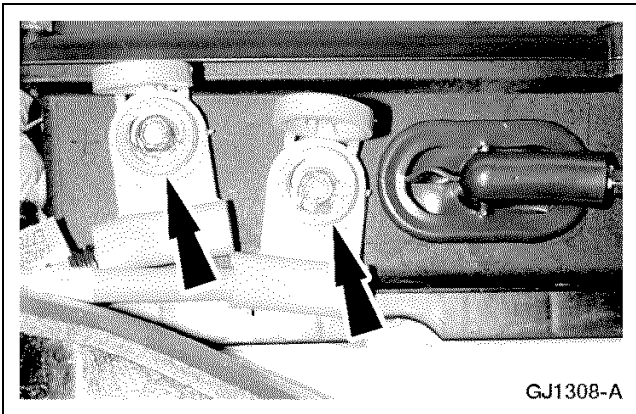

7. Disconnect one HVJ from module 17.

8.  **CAUTION: Disconnect only one HVJ at a time.**

Disconnect the HVJs from the contactor box.

- Use the Battery Terminal Cap Opener to open the HVJ caps.
- Remove the two bolts.
- Wrap the HVJ ends with orange electrical tape.

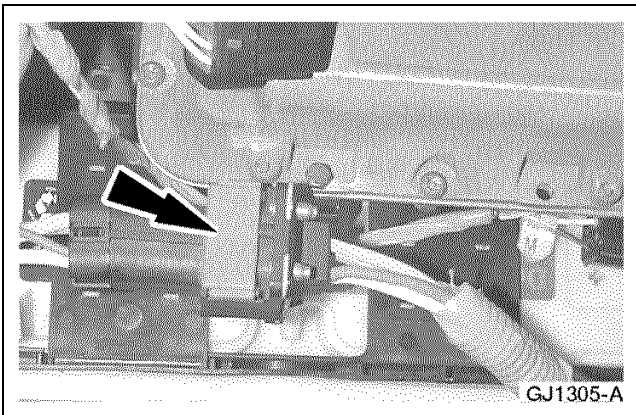

9. Disconnect the contactor box harness.

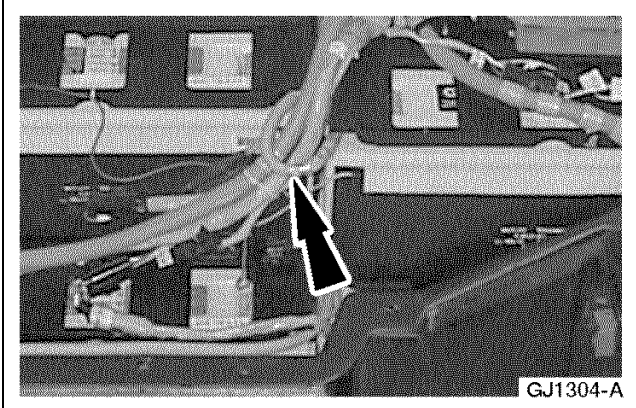

10. Pull the contactor box harness through the loop in the 19 to 18 HVJ.

## REMOVAL AND INSTALLATION (Continued)

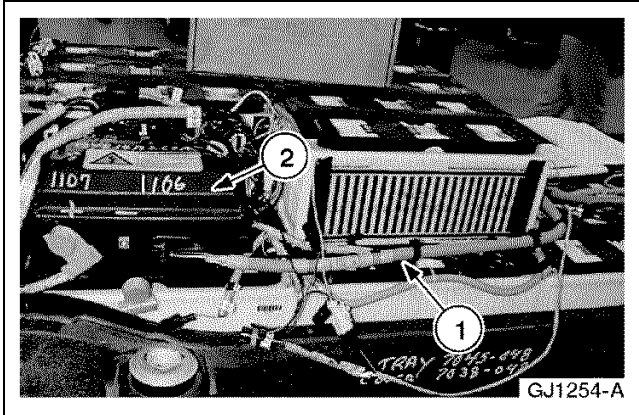

11. Remove the contactor box.

- 1 Unclip the contactor box harness from the separator plate.
- 2 Remove the contactor box.

## Installation

1. To install, reverse the removal procedure.

- 1 Fill the high-voltage jumper connectors with Nyogel after final tightening of the nuts and bolts.
  - Apply Loctite 242 to the 22 traction battery cover bolts.

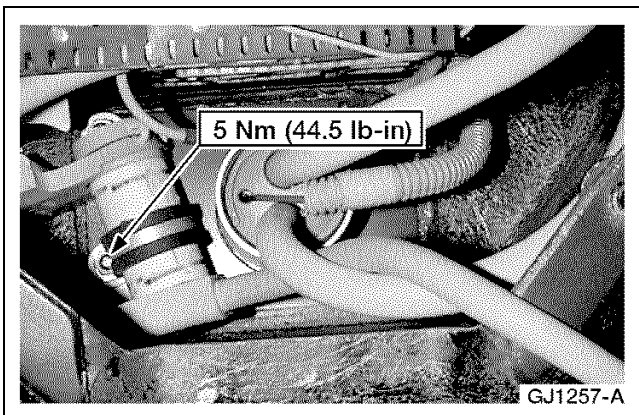
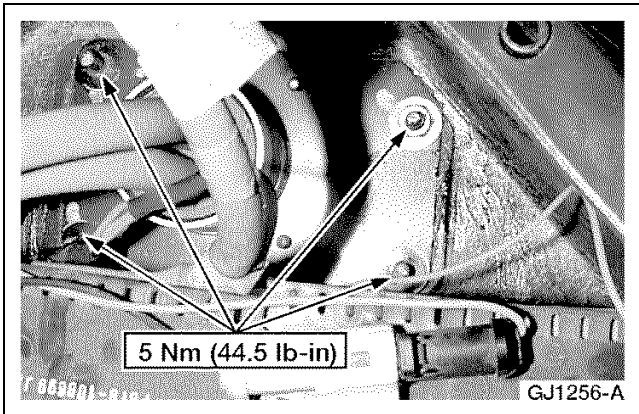
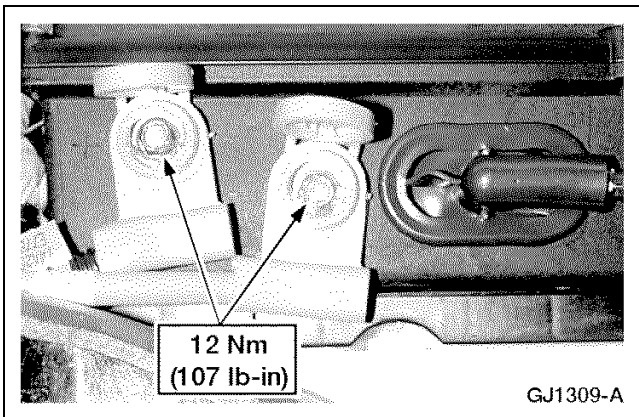

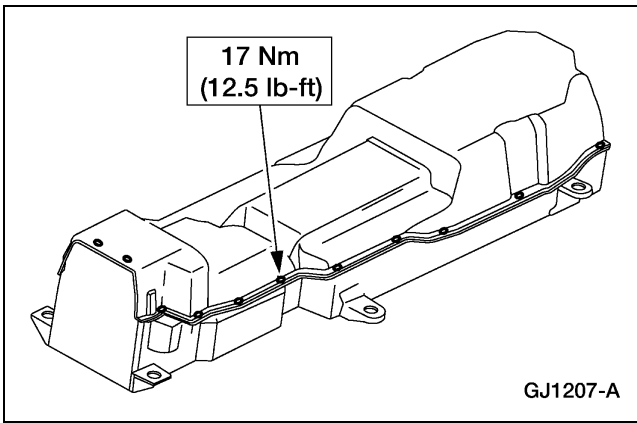
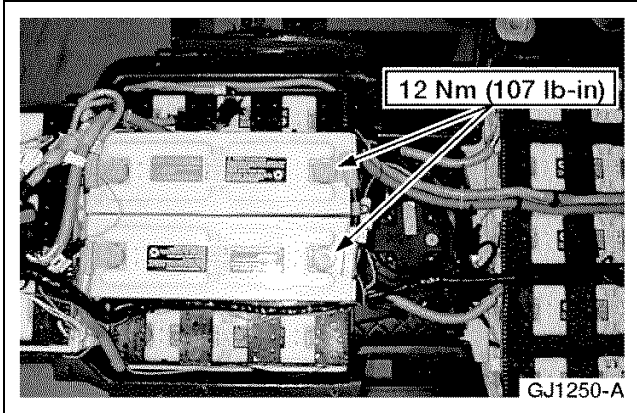
**REMOVAL AND INSTALLATION (Continued)****Contactor Box Fuses****Removal**

1. Remove the traction battery. Refer to [Traction Battery](#).
2. Remove the traction battery cover.
  - 1 Remove the 22 bolts.
  - 2 Remove the cover.

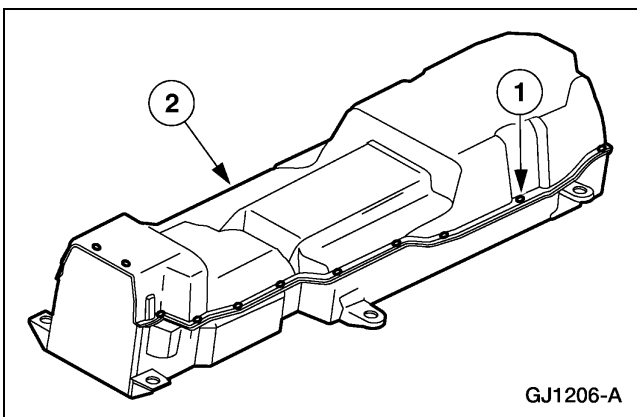

## REMOVAL AND INSTALLATION (Continued)

3.  **WARNING:** The nominal voltage of the traction battery is 312 volts. The buffer zone must be set up and insulated rubber gloves and a face shield must be worn. Failure to follow these precautions may result in severe personal injury or death.

Observe the EV-specific precautions. Refer to [Section 100-00](#).

- 1 Set up the buffer zone.
- 2 Test and wear the insulated rubber gloves.
- 3 Wear the face shield.

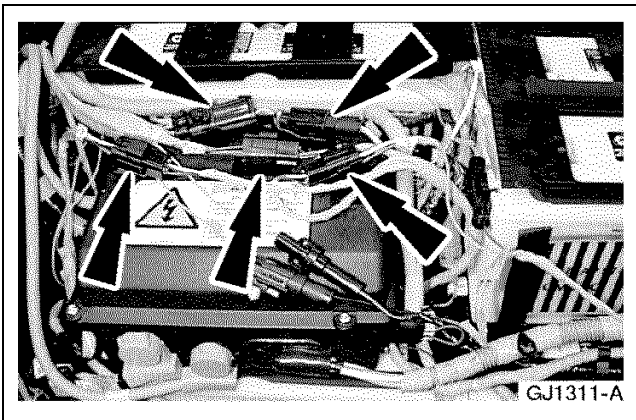

4. Pull the connectors from the top of the contactor box.

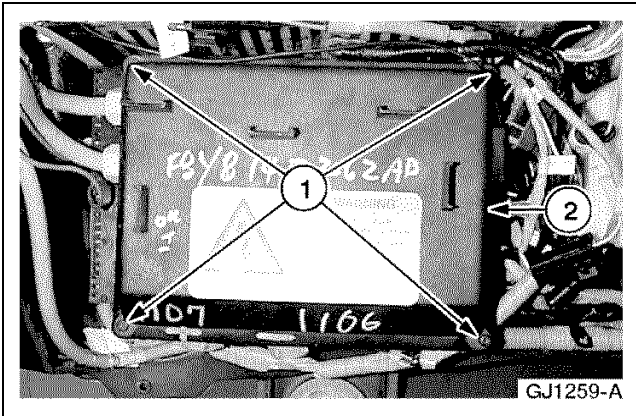

5. Open the contactor box.
  - 1 Remove the four screws.
  - 2 Open the contactor box.

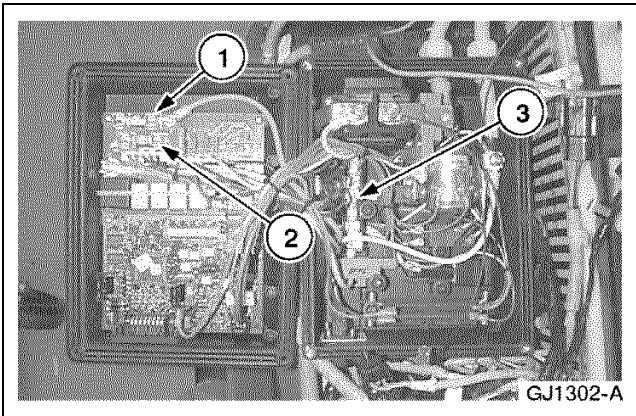

6. Use a fuse puller to remove the necessary fuse.
  - 1 25A Charger Fuse
  - 2 10A Heater Fuse
  - 3 40A Auxiliary Fuse

## REMOVAL AND INSTALLATION (Continued)

### Installation

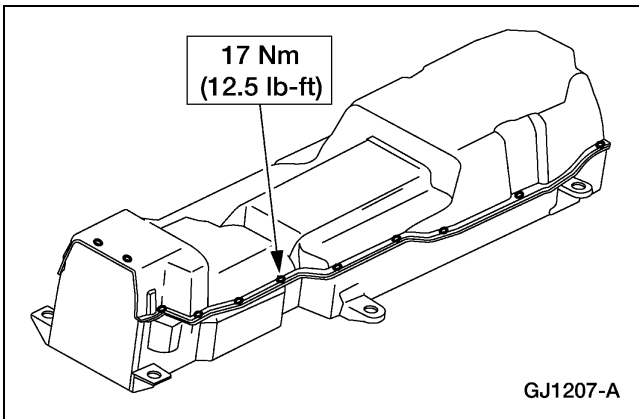
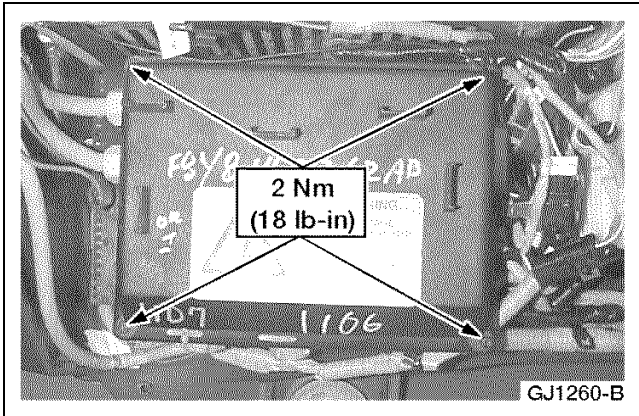

- To install, reverse the removal procedure.
  - Apply Loctite 242 to the 22 traction battery cover bolts.

### HVPDB Fuses

#### Removal

- Disconnect the traction battery auxiliary load high-voltage connector. Refer to [Section 100-05](#).
- Remove the high-voltage power distribution box (HVPDB) cover.
  - Remove the four screws.
  - Remove the cover.

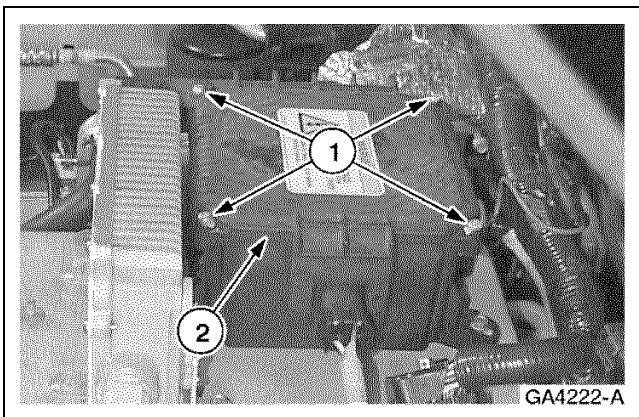

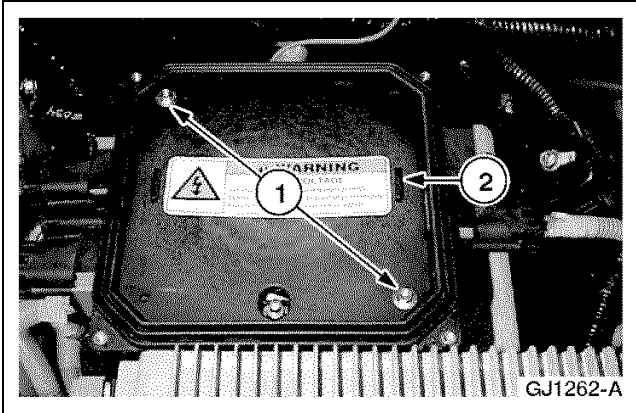

**REMOVAL AND INSTALLATION (Continued)**

3. Remove the HVPDB fuse safety cover.
  - 1 Remove the two screws.
  - 2 Remove the cover.

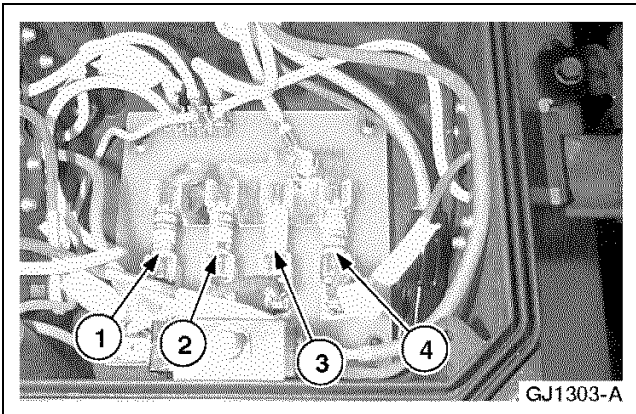

4. Use a fuse puller to remove the necessary fuse.
  - 1 10A Power Steering Fuse
  - 2 25A Positive Temperature Coefficient (PTC) Heater Fuse
  - 3 25A A/C Fuse
  - 4 10A DC/DC Fuse

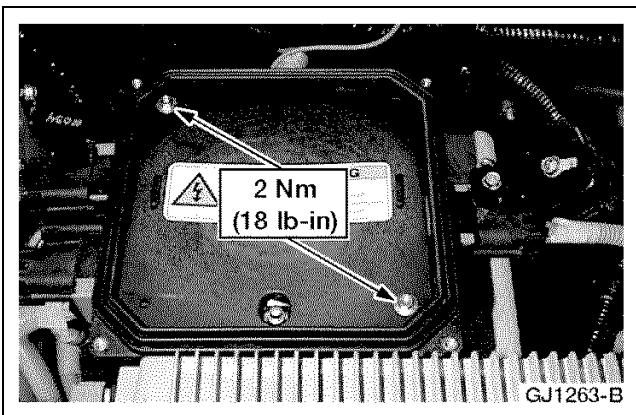
**Installation**

1. To install, reverse the removal procedure.

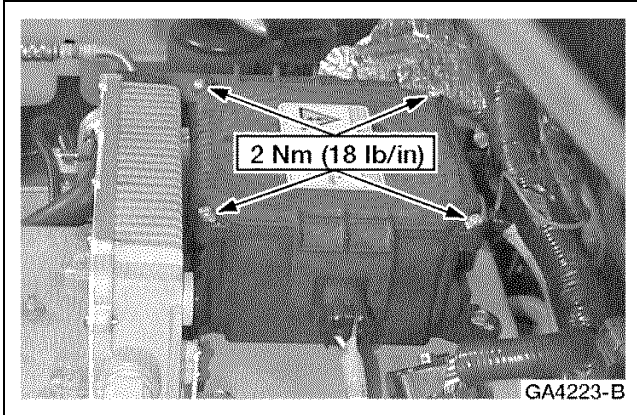
**REMOVAL AND INSTALLATION (Continued)****High Voltage Power Distribution Box (HVPDB)****Removal**

1. Remove the positive temperature coefficient (PTC) module. Refer to [Section 412-04](#).
2. Disconnect the power steering pump electrical connector.
3. Disconnect the electrical connectors.

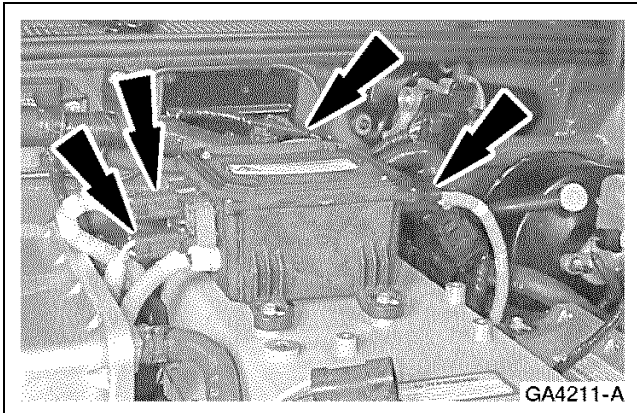
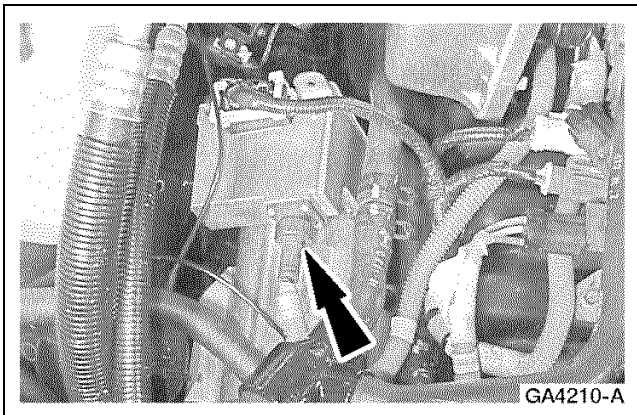

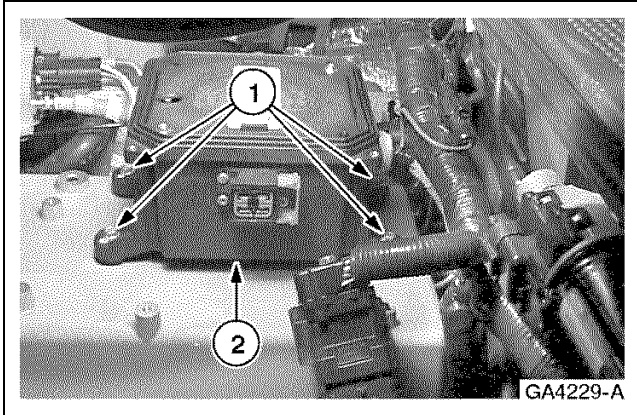
**REMOVAL AND INSTALLATION (Continued)**

4. **NOTE:** The HVPDB power supply cable is held in position with three clips.

Remove the HVPDB.

- 1 Remove the bolts.
- 2 Remove the HVPDB.

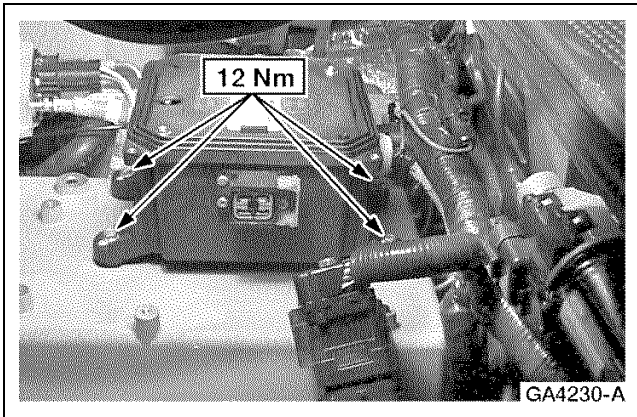
**Installation**

1. To install, reverse the removal procedure.

**High Voltage Wiring —Sensory Lead Harness (10B694)****Removal**

1. Remove the traction battery. Refer to [Traction Battery](#).
2. Remove the traction battery cover.
  - 1 Remove the 22 bolts.
  - 2 Remove the cover.

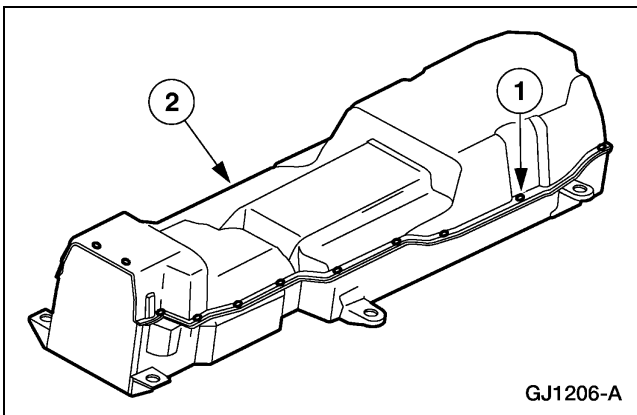

## REMOVAL AND INSTALLATION (Continued)

3.  **WARNING:** The nominal voltage of the traction battery is 312 volts. The buffer zone must be set up and insulated rubber gloves and a face shield must be worn. Failure to follow these precautions may result in severe personal injury or death.

Observe the EV specific precautions. Refer to [Section 100-00](#).

- 1 Set up the buffer zone.
- 2 Test and wear the insulated rubber gloves.
- 3 Wear the face shield.

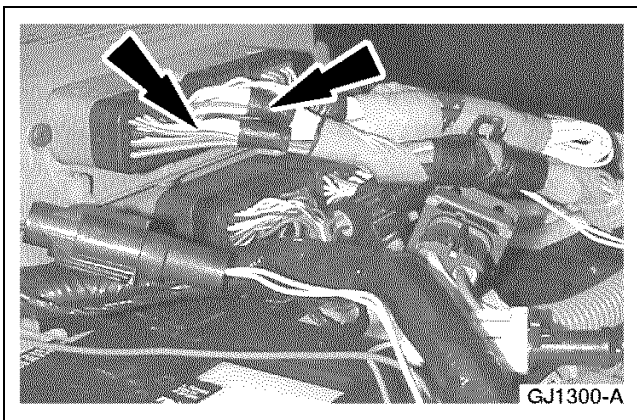

4. Disconnect the high-voltage sense lead harness from the battery control module (BCM).
- Loosen the two connector bolts.

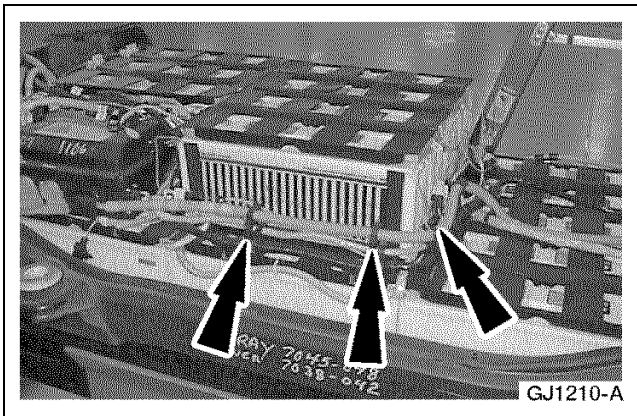

5. Unclip the low and high-voltage wiring harnesses from each other and from the separator plate.

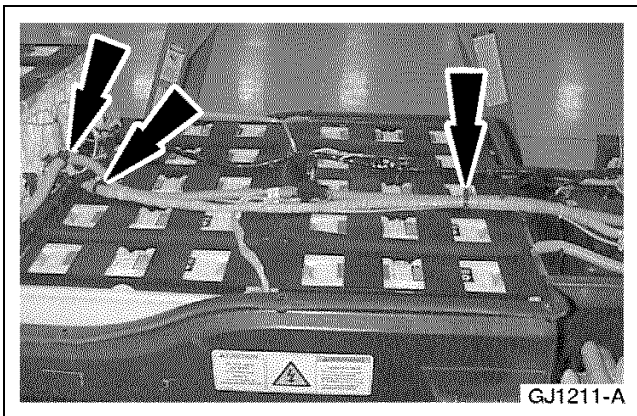

6. Unclip the low and high-voltage wiring harnesses from each other and from the separator plate.
- Cut the zip tie.

## REMOVAL AND INSTALLATION (Continued)

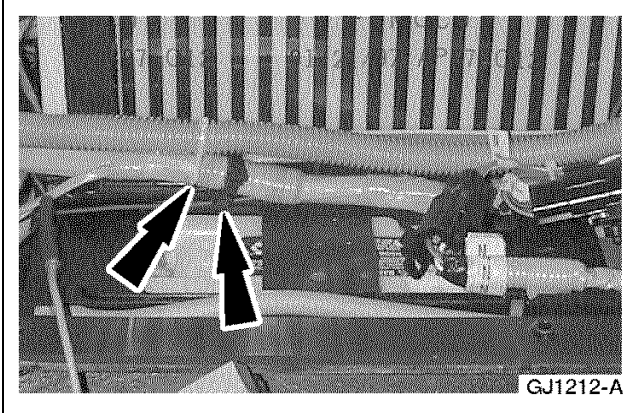

7. **⚠ WARNING:** Do not cut into the orange high-voltage wiring harness.

**⚠ CAUTION:** Do not allow the zip tie to fall into the traction battery. Verify that all zip ties are removed from the traction battery.

Unclip the low and high-voltage wiring harnesses from each other and from the separator plate.

- Cut the zip tie.

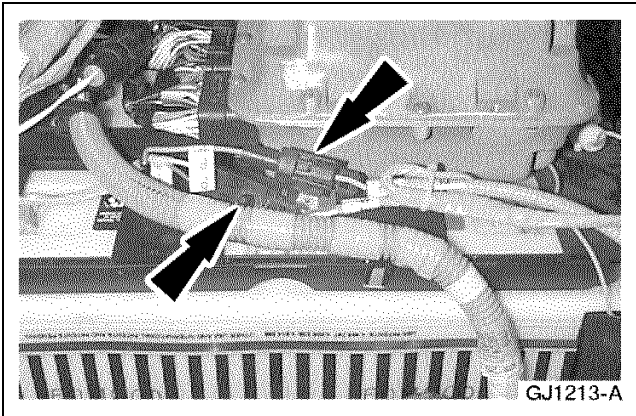

8. **NOTE:** There are 20 sense lead wiring connectors. They can be identified by a white tag with a black letter.

Unclip and disconnect the sense lead wiring connectors.

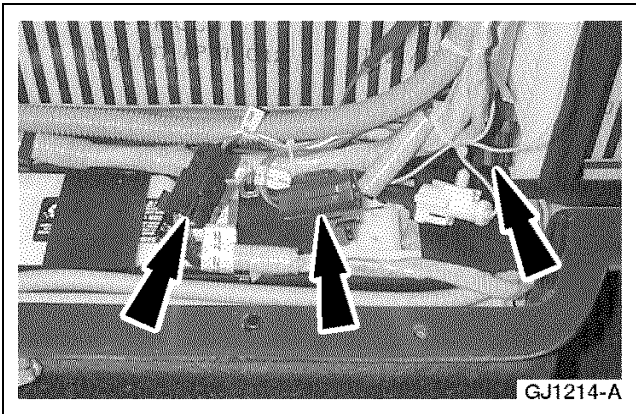

9. Unclip and disconnect the sense lead wiring.

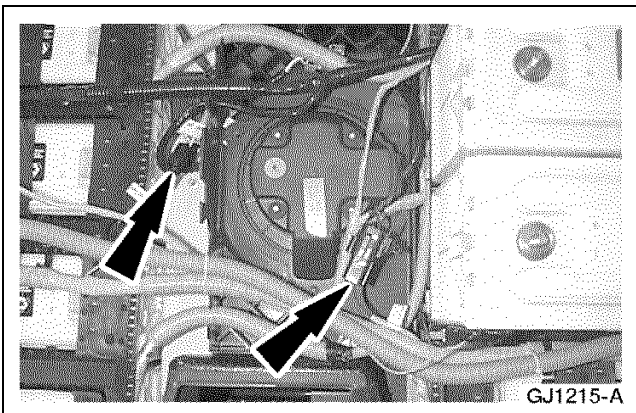

10. Unclip and disconnect the sense lead wiring.

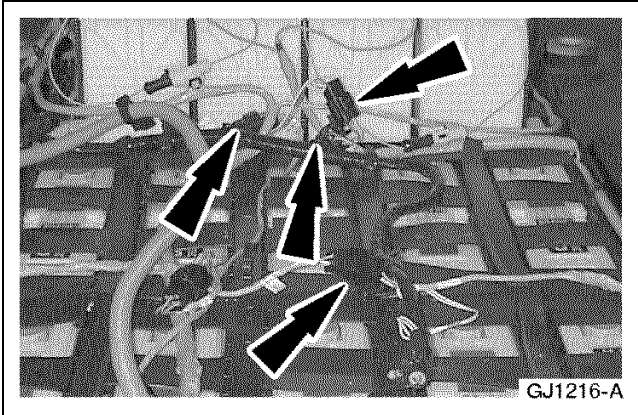
**REMOVAL AND INSTALLATION (Continued)**

11. Unclip and disconnect the sense lead wiring.

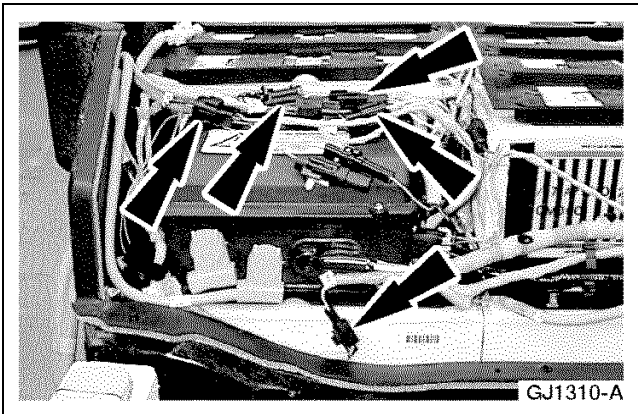

12. Unclip and disconnect the sense lead wiring.

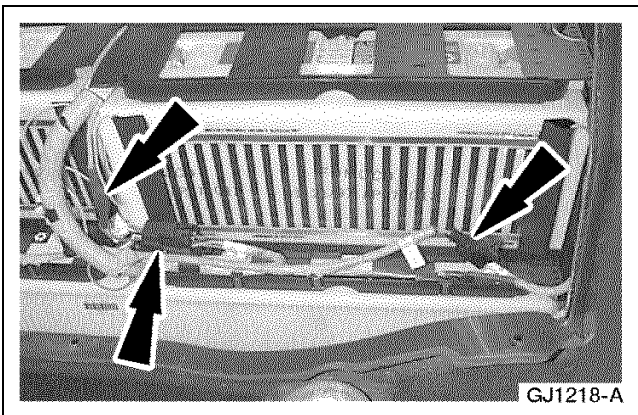

13. Unclip and disconnect the sense lead wiring.

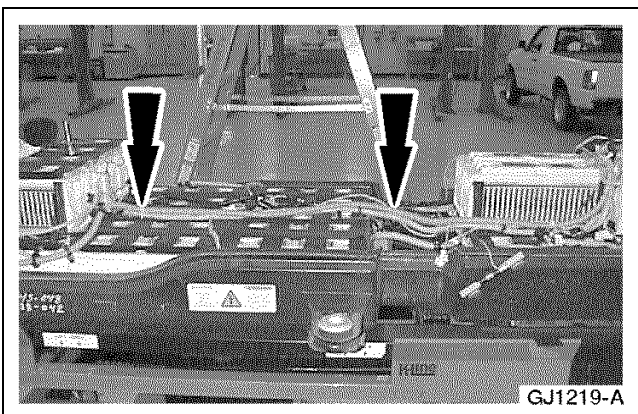

14. Cut the two zip ties from the high-voltage harness.

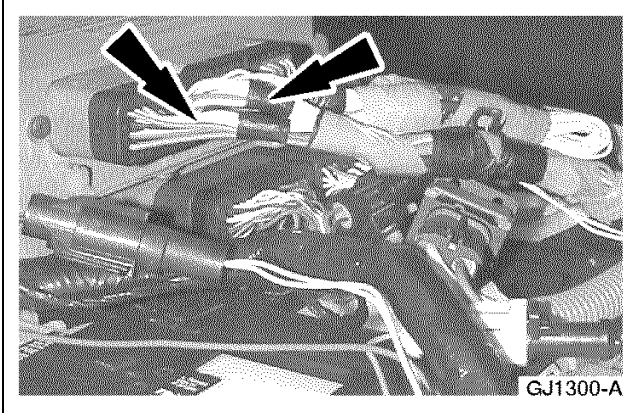
**REMOVAL AND INSTALLATION (Continued)**

15. Disconnect the multi-pin connectors from the battery control module (BCM).
  - Loosen the two bolts.

16. Remove the high-voltage sense lead harness.

**Installation**

1. To install, reverse the removal procedure.
  - Apply Locktite 242 to the 22 traction battery cover bolts.

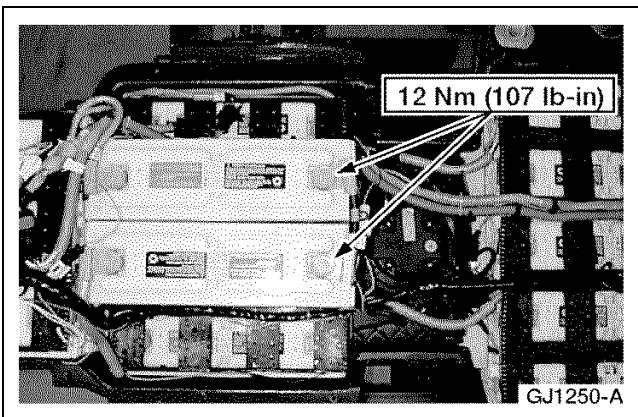
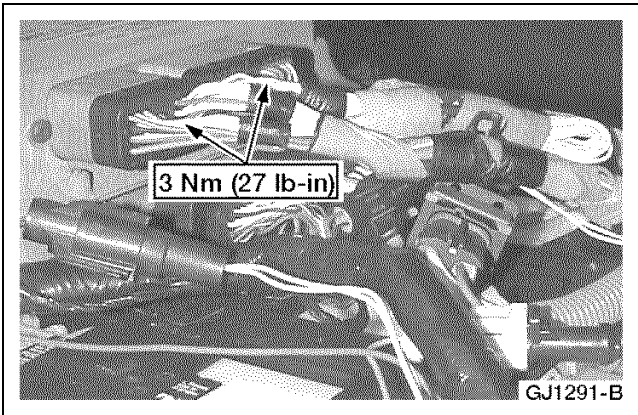

**REMOVAL AND INSTALLATION (Continued)**

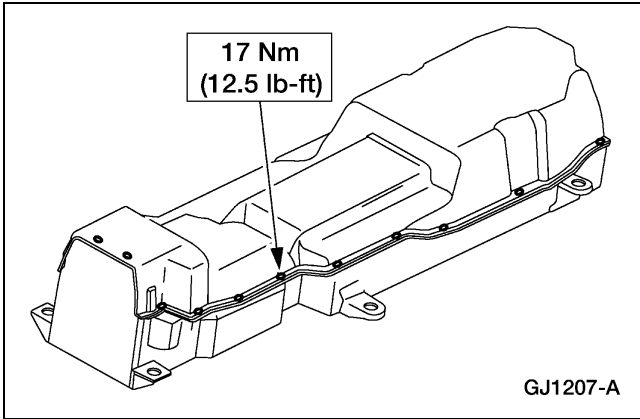

**High Voltage Wiring**

**Special Tool(s)**

<p>ST2091-A</p>	<p>Battery Terminal Cap Opener 418-F215</p>
-----------------	---



**REMOVAL AND INSTALLATION (Continued)**

**High-Voltage Jumper Routing**

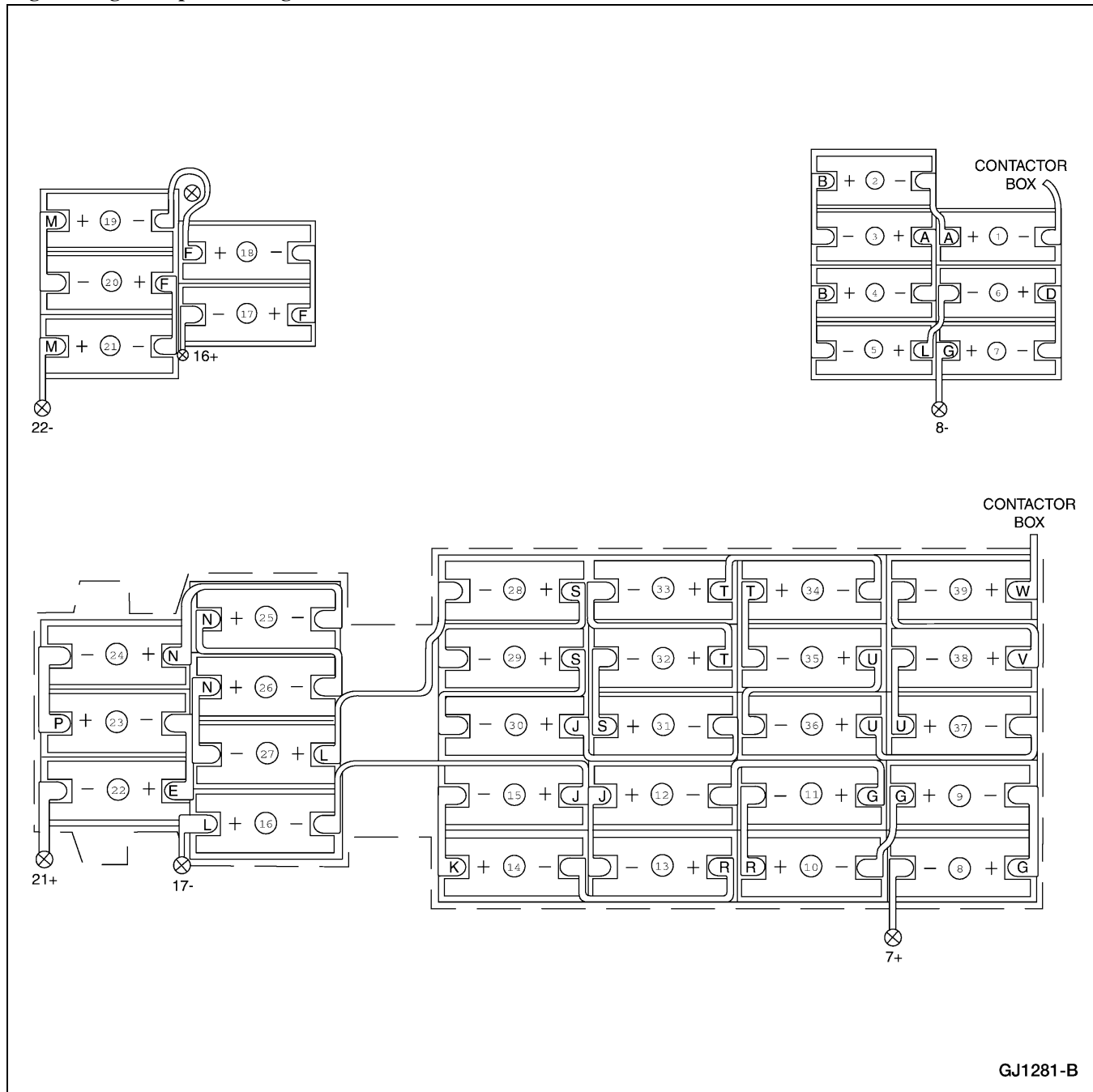

**Removal**

1. Remove the traction battery. Refer to [Traction Battery](#).

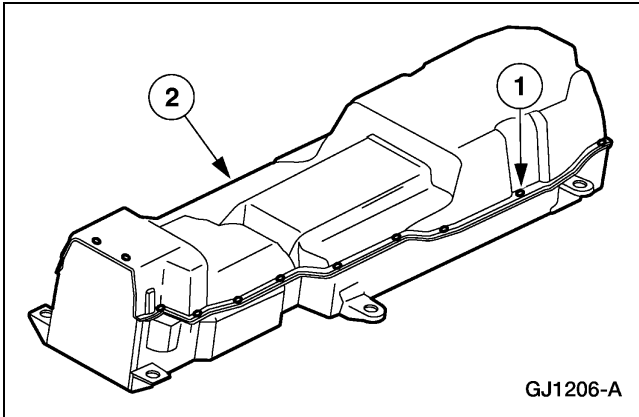
**REMOVAL AND INSTALLATION (Continued)**

2. Remove the traction battery cover.
  - 1 Remove the 22 bolts.
  - 2 Remove the cover.
  
3.  **WARNING: The nominal voltage of the traction battery is 312 volts. The buffer zone must be set up and insulated rubber gloves and a face shield must be worn. Failure to follow these precautions may result in severe personal injury or death.**  
Observe the EV-specific precautions. Refer to [Section 100-00](#).
  - 1 Set up the buffer zone.
  - 2 Test and wear the insulated rubber gloves.
  - 3 Wear the face shield.
  
4. Refer to the High-Voltage Jumper (HVJ) wiring diagram to determine the location of the HVJ to be replaced.
  
5. Remove the battery modules or components necessary to gain access to the HVJ. Refer to the procedures in this section.
  
6. **NOTE:** The sense lead is a thin orange wire that is part of the HVJ.  
Disconnect the sense lead connector for the HVJ being removed.

## REMOVAL AND INSTALLATION (Continued)

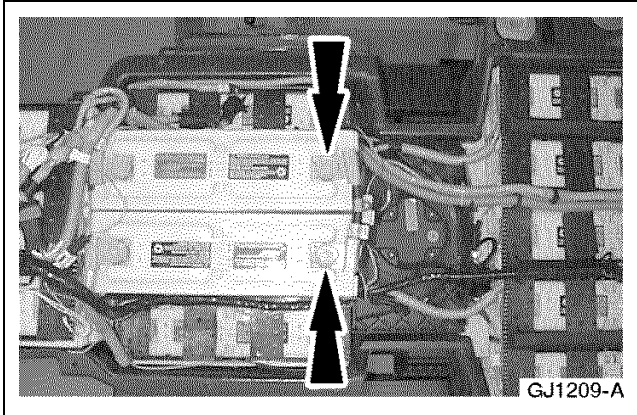

7. Remove the HVJ.
  - Use the Battery Terminal Cap Opener to open the battery module caps.
  - Remove and discard the two nuts.

### Installation

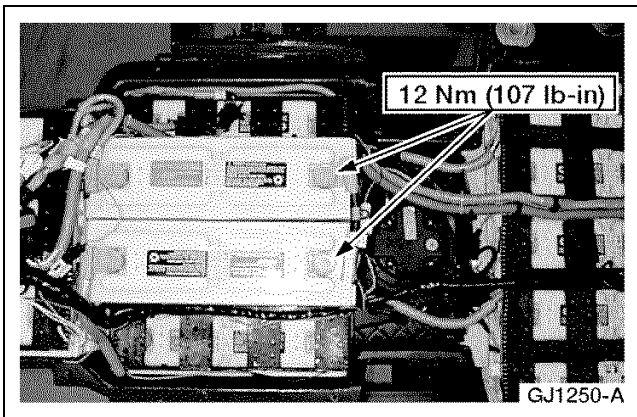

1. To install, reverse the removal procedure.
  - When installing the HVJ on the battery module, route the sense lead wiring under the HVJ cable.
  - Refill the HVJ caps with Nyogel after tightening the nuts.
  - Apply Locktite 242 to the 22 traction battery cover bolts.

## Traction Battery

### Removal

**NOTE:** The total traction battery removal and installation time is 40 minutes.

1. Disconnect the traction battery auxiliary load high-voltage connector. Refer to [Section 100-05](#).
2. Disconnect the traction battery high-voltage two-pin connector. Refer to [Section 100-05](#).

## REMOVAL AND INSTALLATION (Continued)

3.  **WARNING:** The nominal voltage of the traction battery is 312 volts. The buffer zone must be set up and insulated rubber gloves and a face shield must be worn. Failure to follow these precautions may result in severe personal injury or death.

Observe the EV-specific precautions. Refer to [Section 100-00](#).

- 1 Set up the buffer zone.
- 2 Test and wear the insulated rubber gloves.
- 3 Wear the face shield.

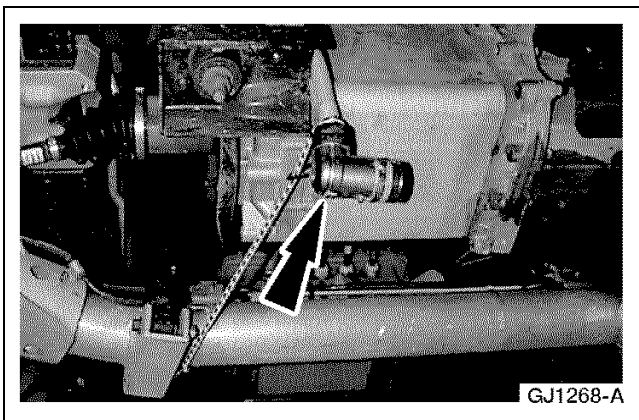

4. Secure the two-pin high-voltage cable to the rear axle to hold it out of the way.

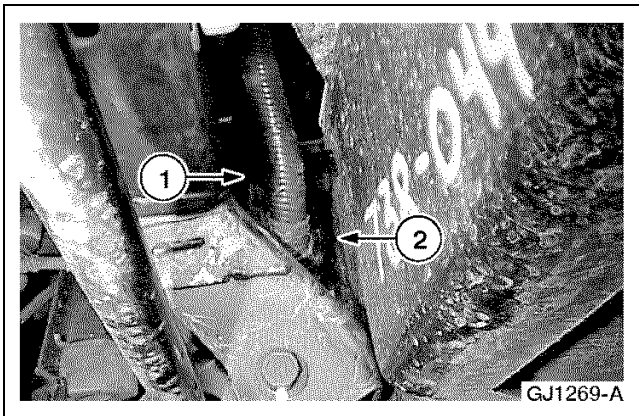

5. Disconnect the 76-pin electrical connector.
- 1 Loosen the bolt.
  - 2 Disconnect the electrical connector.

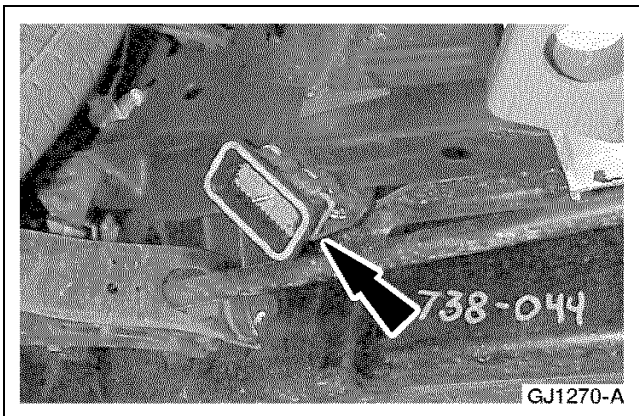

6. Position the 76-pin electrical connector over the control arm.

## REMOVAL AND INSTALLATION (Continued)

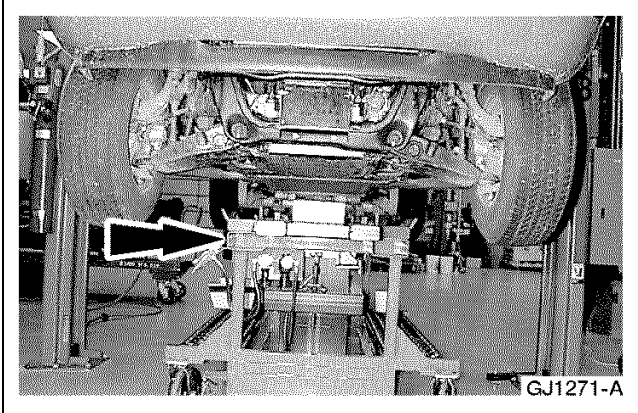

7. Position the lift table under the battery pack assembly.
  - The narrow end of the pallet faces the front of the vehicle.

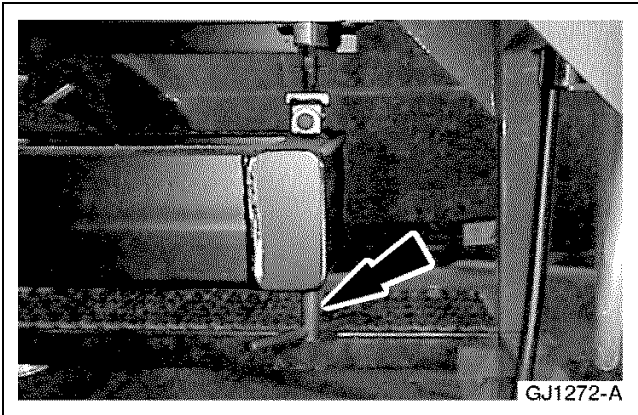

8. Completely lower the lift table and then lower the vehicle until the battery pack is within 25.5 cm (10 in) of the lift table. Verify that the safety locks on the lift are engaged.
9. Adjust the lift table so it is parallel with the battery pack.
  - Turn the adjustment screw at the front of the lift table to vary the angle of the lift table.

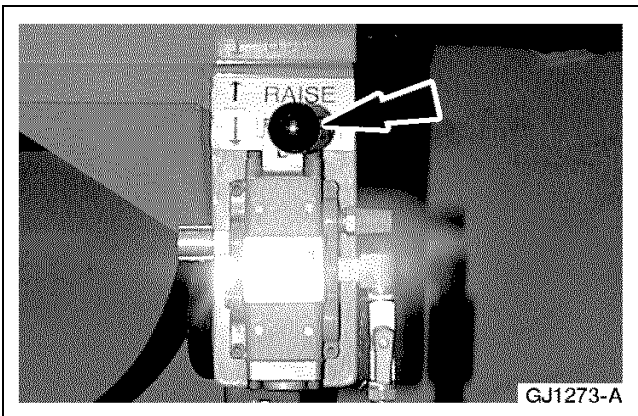

10. **NOTE:** A second person is necessary to position and guide the lift table.  
Align the lift table with the battery pack.
11. **NOTE:** The lift table operates using a minimum of 80 psi and a maximum of 120 psi of compressed air.  
Slowly raise the lift table until it contacts the bottom of the battery pack.
  - Push the lever up.

## REMOVAL AND INSTALLATION (Continued)

12.  **CAUTION: Do not adjust either regulator for more than 60 psi.**

**NOTE:** The lift table is designed to only lift the battery pack assembly. It will not lift the entire vehicle.

Continue to lift the battery pack until the lift table system pressure equalizes and both gauges reach 60 psi.

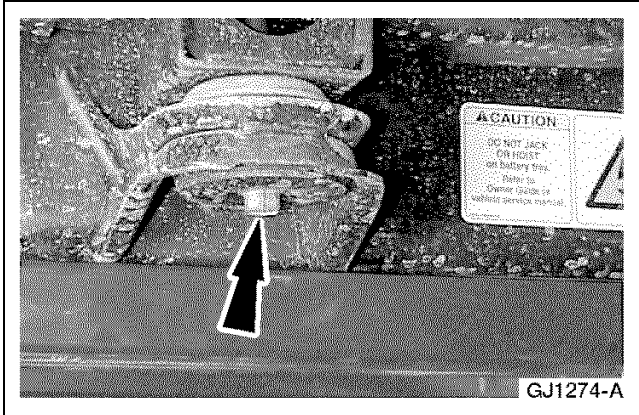

13. **NOTE:** There are three mounting bolts on both the left and right sides of the traction battery. Remove the six mounting bolts from the battery pack.

14. Lower the lift table slowly until it rests on the pallet stops and system pressure is completely released (0 psi).

15. Raise the vehicle.

16. Release the lift table brake, disconnect the air hose, and roll the lift table from under the vehicle.

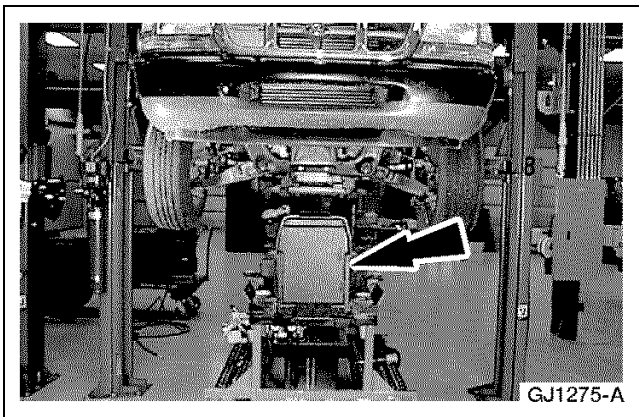

### Installation

1. Raise and support the vehicle. Refer to [Section 100-02](#).

## REMOVAL AND INSTALLATION (Continued)

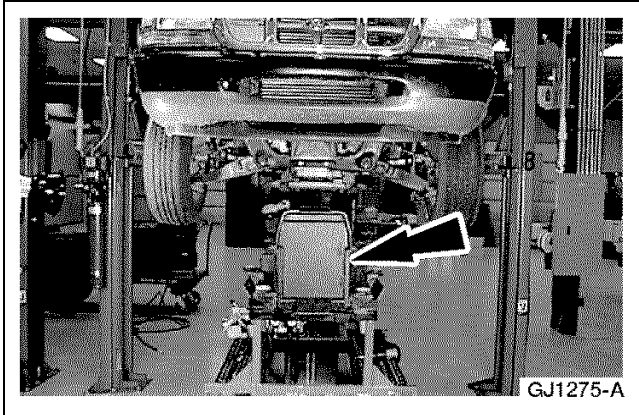

2. Position the lift table and battery pack under the vehicle.
  - Connect the lift table to the shop air supply.

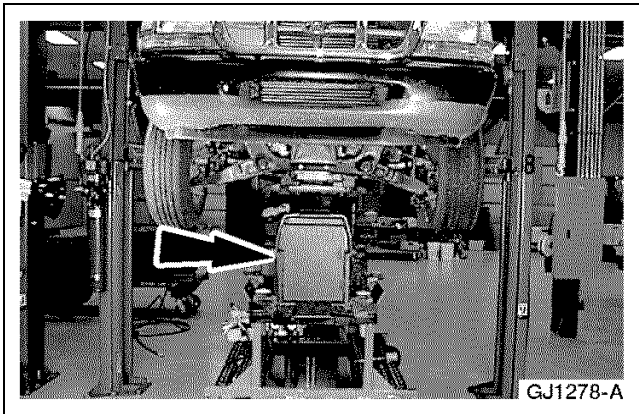

3. With the assistance of a second person, carefully lower the vehicle down to within ten inches of the battery pack.
4.  **CAUTION: Make sure the vehicle and battery pack are aligned during battery pack installation.**  
Lift the battery pack up into the mounting position.

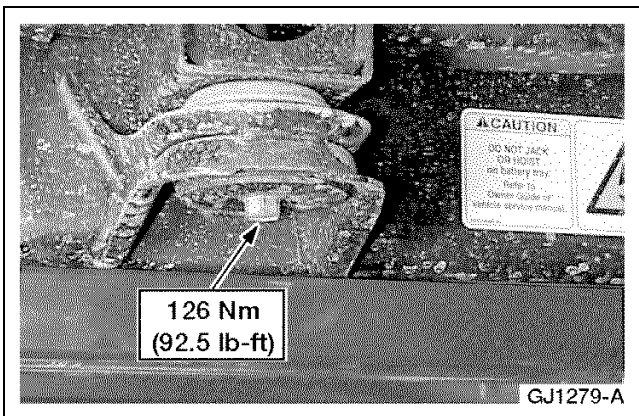

5. **NOTE:** The LH front bolt must be installed first in order to properly align the battery pack. Install the battery pack mounting bolts.
  - Apply Loctite 242 to the bolts prior to installation.
  - Install the LH front bolt first in order to properly locate the battery pack.
6. Lower the lift table and disconnect the shop air source.
7. Raise the vehicle and roll the lift table from under the vehicle.

## REMOVAL AND INSTALLATION (Continued)

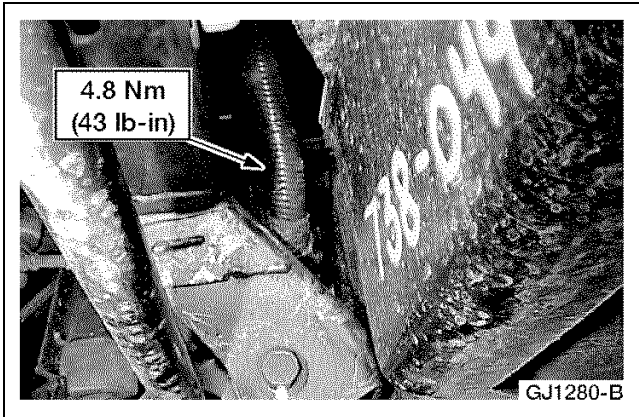

8. **NOTE:** The bolt will break if the specified torque is exceeded. If this happens, pull the connector off the bolt stem and remove the broken bolt.

Connect the 76-pin connector.

- 1 Position the connector.
- 2 Tighten the bolt.

9. Connect the traction battery auxiliary load high-voltage connector. Refer to [Section 100-05](#).
10. Connect the traction battery two-pin high-voltage connector. Refer to [Section 100-05](#).

## Traction Battery Charger

### Removal

1. Remove the high-voltage power distribution box (HVPDB). Refer to [High Voltage Power Distribution Box \(HVPDB\)](#).
2. Disconnect the traction battery charger electrical connectors.

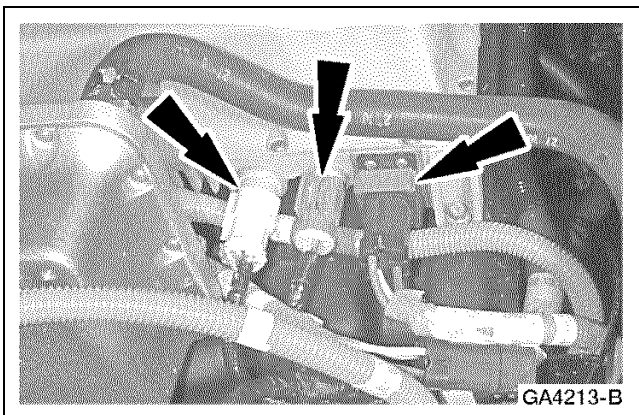



## REMOVAL AND INSTALLATION (Continued)

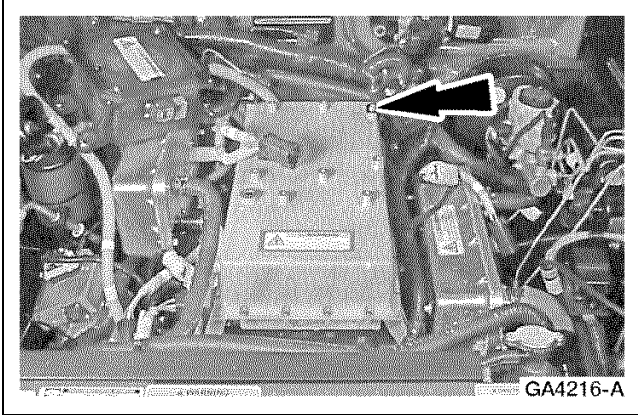

3. Remove the harness bracket.
  - Remove the bolt.

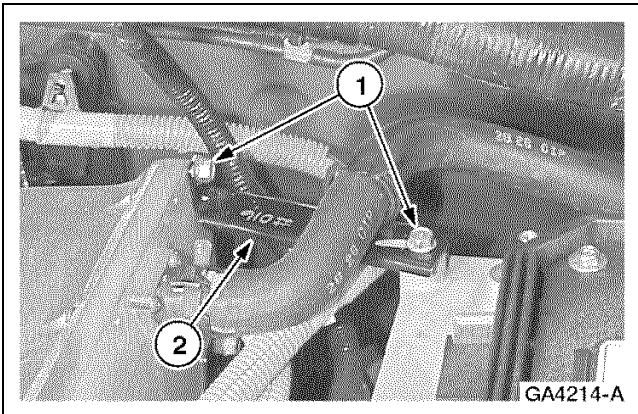

4. Remove the A/C inverter motor controller (IMC) bracket.
  - 1 Remove the bolts.
  - 2 Remove the bracket.

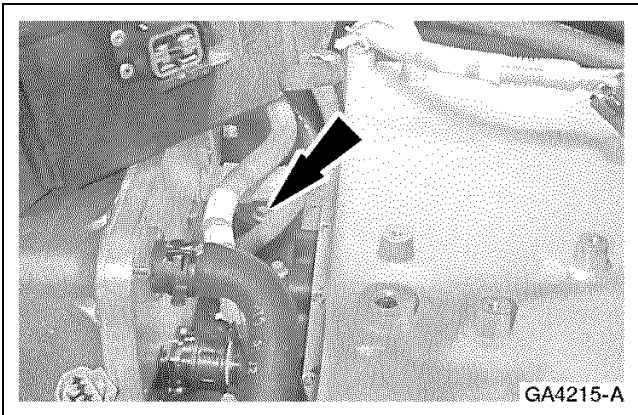

5. Remove the ground strap bolt.

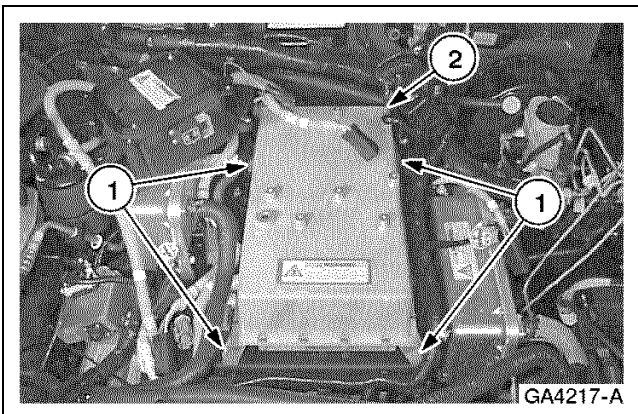

6. Remove the traction battery charger.
  - 1 Remove the four bolts.
  - 2 Remove the charger.

**REMOVAL AND INSTALLATION (Continued)****Installation**

1. To install, reverse the removal procedure.

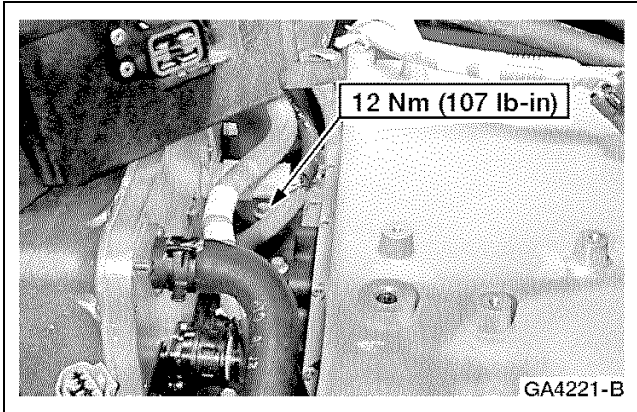
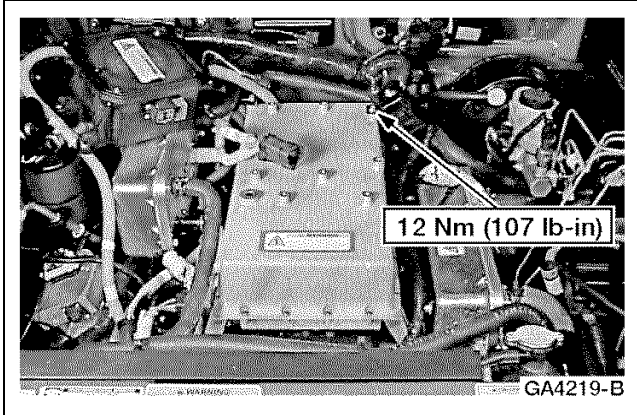
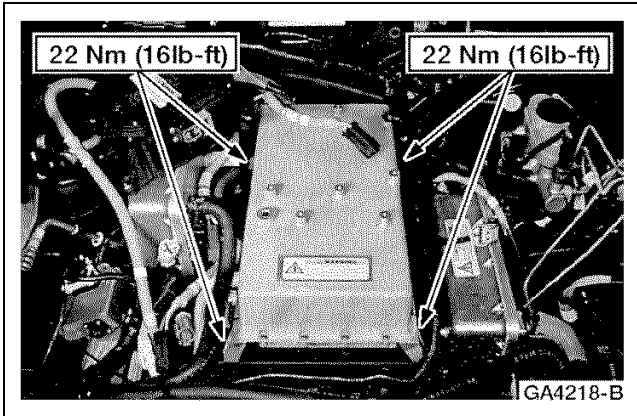

## REMOVAL AND INSTALLATION (Continued)

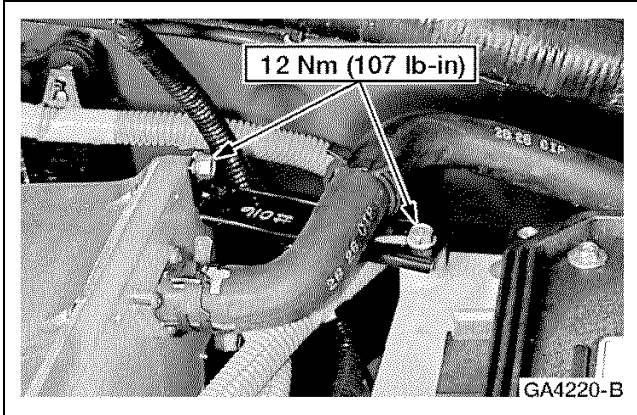

## Traction Battery Cooling/Ventilation Fan

### Removal

1. Remove the traction battery. Refer to [Traction Battery](#).

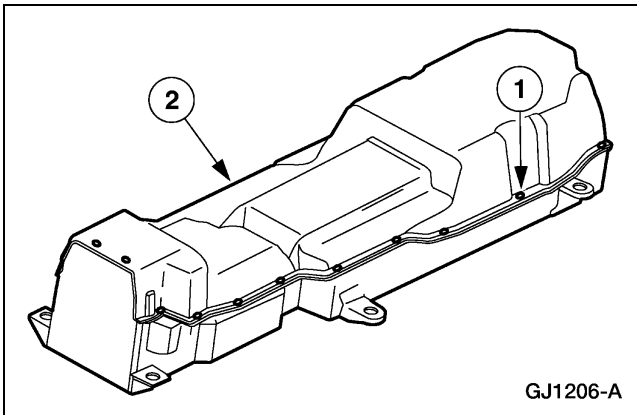

2. Remove the traction battery cover.
  - 1 Remove the 22 bolts.
  - 2 Remove the cover.

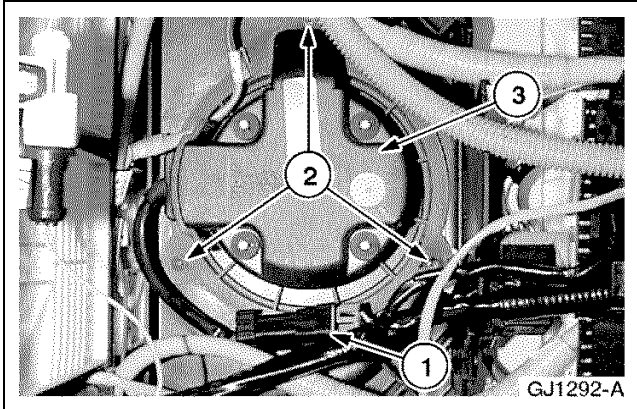

3. Remove the traction battery cooling fan.
  - 1 Disconnect the cooling fan electrical connector.
  - 2 Remove the three screws.
  - 3 Remove the cooling fan.

**REMOVAL AND INSTALLATION (Continued)****Installation**

1. To install, reverse the removal procedure.

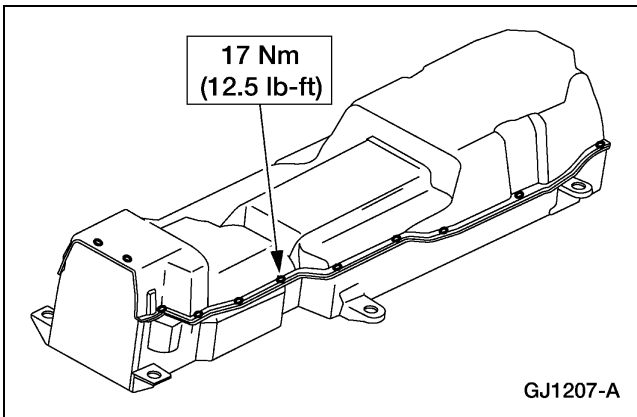
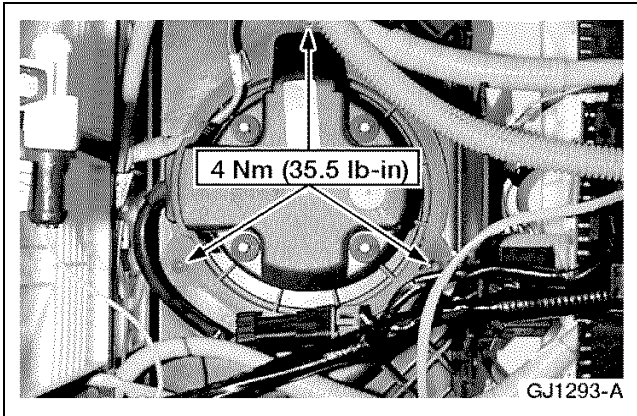

---

**REMOVAL AND INSTALLATION (Continued)****Traction Battery Heating Elements (U/L) —Upper****Removal**

1. **NOTE:** If any of the upper battery modules are replaced, do NOT attempt to reinstall the original heating element. Always install a new Heating Element when installing a new replacement battery module.

**NOTE:** When viewing a heater element, with the adhesive side on the back, the elements with the male electrical connector on the left side are considered LH heater elements. Elements with the male connector on the right side are considered RH elements.

The upper level heating elements are mounted on the side of the battery modules. They are adhesive backed, and the battery module must be removed in order to replace the heating element. Refer to the specific traction battery module procedure in this section.

- Modules 1, 4, 20, and 21 are equipped with LH heater elements.
- Battery modules 2, 3, 5, 6, 7, 17, 18, and 19 are equipped with RH heater elements.

**Installation**

1. The battery module removal and installation procedures contain the heater element removal and installation. Install the battery modules equipped with the new heater elements. Refer to the appropriate traction battery module procedure in this section.
- 

**Traction Battery Heating Elements (U/L) —Lower****Removal**

1. The lower traction battery heating element is located in the bottom of the traction battery tray. The entire traction battery must be disassembled in order to remove and install the heating element. Refer to the traction battery disassembly procedure in this section.

---

**REMOVAL AND INSTALLATION (Continued)****Installation**

1. The lower traction battery heating element is located in the bottom of the traction battery tray. The entire traction battery must be disassembled in order to remove and install the heating element. Refer to the traction battery assembly procedure in this section.
- 

**Traction Battery High Voltage Fuse (250A)****Special Tool(s)**

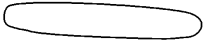
 ST2091-A	Battery Terminal Cap Opener 418-F215
---	---

**Removal**

1. Remove the traction battery. Refer to [Traction Battery](#).
2.  **WARNING: The nominal voltage of the traction battery is 312 volts. The buffer zone must be set up and insulated rubber gloves and a face shield must be worn. Failure to follow these precautions may result in severe personal injury or death.**  
Observe the EV-specific precautions. Refer to [Section 100-00](#).
  - 1 Set up the buffer zone.
  - 2 Test and wear the insulated rubber gloves.
  - 3 Wear the face shield.

## REMOVAL AND INSTALLATION (Continued)

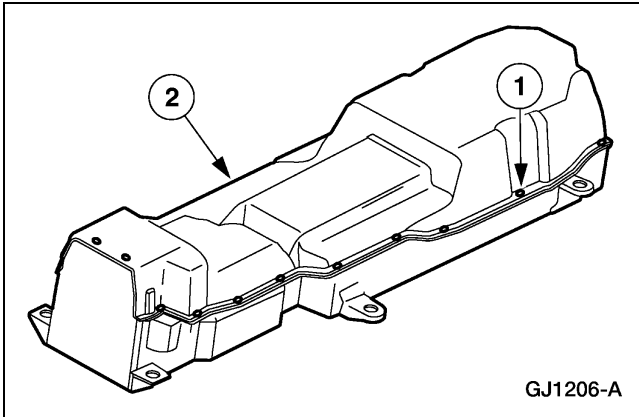

3. Remove the traction battery cover.
  - 1 Remove the 22 bolts.
  - 2 Remove the cover.

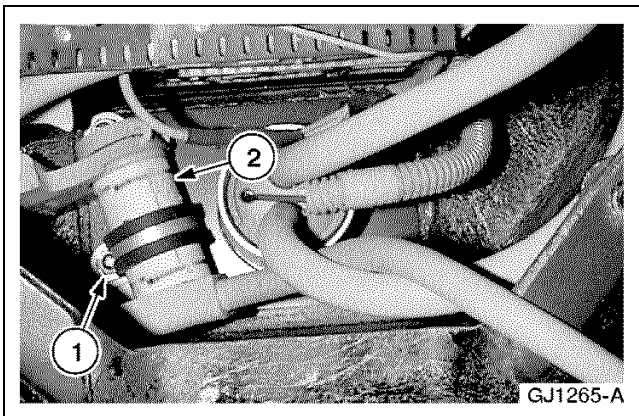

4. Position the high-voltage fuse aside.
  - 1 Remove the nut.
  - 2 Move the fuse up and out of the traction battery pack.

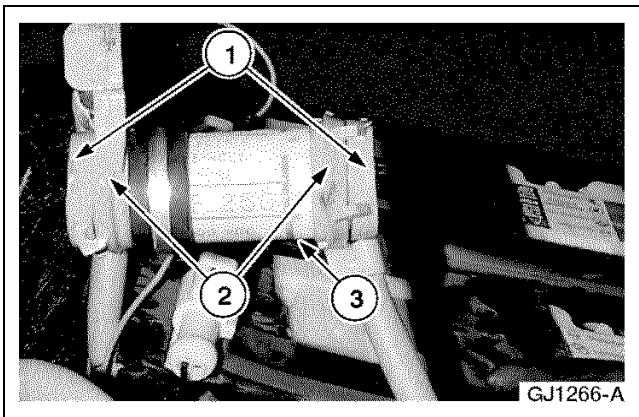

5. **⚠ WARNING: Do not allow the HVJs to touch each other once they are removed from the high-voltage fuse. The HVJs contain high DC voltage and may cause severe personal injury or death.**

Remove the high-voltage fuse.

- 1 Use the Battery Terminal Cap Opener to open the battery module caps.
- 2 Remove the two bolts.
- 3 Remove the fuse.

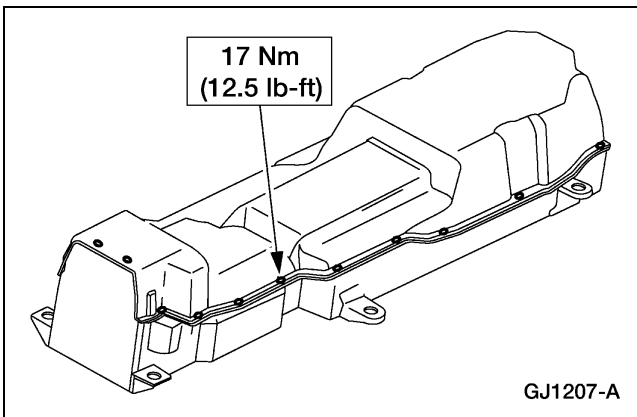
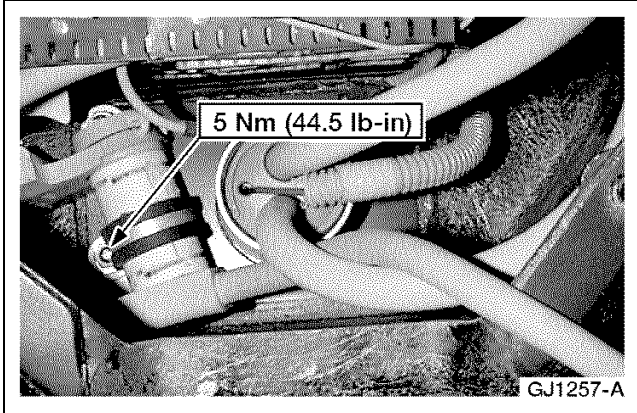
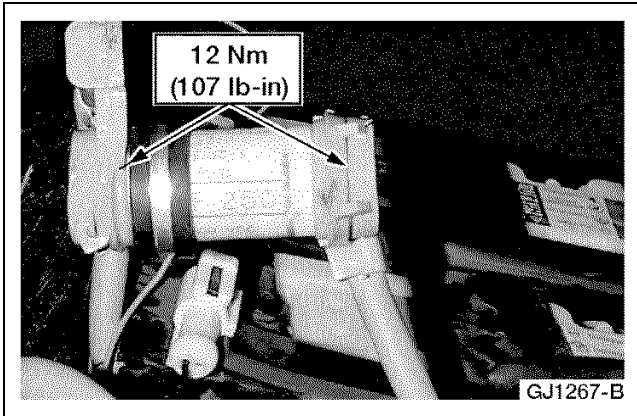
**REMOVAL AND INSTALLATION (Continued)****Installation**

1. To install, reverse the removal procedure.
  - Fill the area around the high-voltage fuse bolts with Nyogel.
  - Apply Loctite 242 to the 22 traction battery cover bolts.

**Traction Battery Module —Modules 1-7****Removal**

1. The battery modules are located on the upper level of the traction battery. Replace the faulty battery module(s). Refer to [Traction Battery Module Replacement](#).



---

**REMOVAL AND INSTALLATION (Continued)****Installation**

1. The battery module replacement procedure also contains the battery module installation.
- 

**Traction Battery Module —Modules 17-18****Removal**

1. These two battery modules are located in the upper level near the front of the traction battery. Replace the faulty battery module(s). Refer to [Battery Control Module \(BCM\)](#).

**Installation**

1. The battery module replacement procedure also contains the battery module installation.
- 

**Traction Battery Module —Modules 19-21****Removal**

1. Remove the battery control module (BCM). Refer to [Battery Control Module \(BCM\)](#).
2. Replace the faulty battery module(s). Refer to [Traction Battery Module Replacement](#).

**Installation**

1. The battery module replacement procedure also contains the battery module installation.
  2. Install the (BCM). Refer to [Battery Control Module \(BCM\)](#).
-

**REMOVAL AND INSTALLATION (Continued)****Traction Battery Module —Modules 8-11****Special Tool(s)**

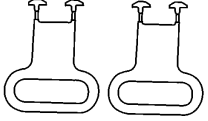
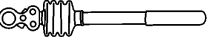
 <p style="text-align: center;">ST2095-A</p>	<p>Battery Module Lifting Tool SR-10009</p>
 <p style="text-align: center;">ST2097-A</p>	<p>Battery Post Torque Wrench 307-026</p>

**Removal**

1.  **WARNING: The nominal voltage of the traction battery is 312 volts. The buffer zone must be set up and insulated rubber gloves and a face shield must be worn. Failure to follow these precautions may result in severe personal injury or death.**  
Observe the EV-specific precautions. Refer to [Section 100-00](#).
  - 1 Set up the buffer zone.
  - 2 Test and wear the insulated rubber gloves.
  - 3 Wear the face shield.
2. Remove battery modules 4-6.
  - Unclip and disconnect the heating element electrical connectors.
  - Remove the separator plates.
  - Remove and discard the high-voltage jumper retaining nuts.
  - Use the Battery Module Lifting Tool to remove the battery modules.
3. Replace the faulty battery module(s). Refer to [Traction Battery Module Replacement](#).

**REMOVAL AND INSTALLATION (Continued)**

**Installation**

1. The battery module replacement procedure also contains the battery module installation.
  
2. Install battery modules 4-6.
  - Use the Battery Module Lifting Tool to install the battery modules.
  - Install and tighten new battery module nuts using the Battery Post Torque Wrench.
  - Install the separator plates.
  - Connect the heating element connectors.
  - Clip the connectors into the separator plate.
  
3. Fill the area around the high-voltage jumper nuts with Nyogel.

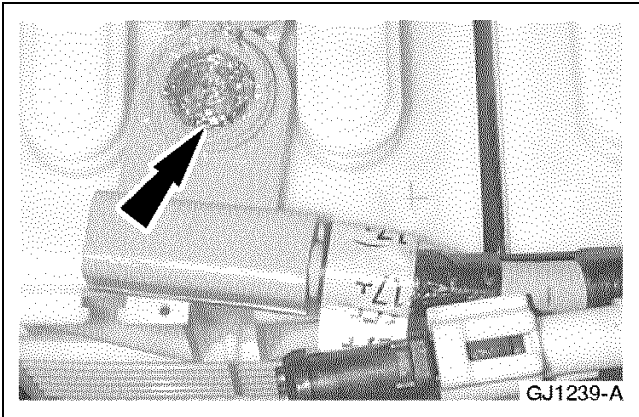

**Traction Battery Module — Modules 34-39**

**Special Tool(s)**

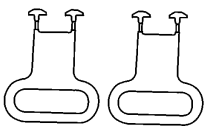
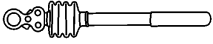
 <p style="text-align: center;">ST2095-A</p>	<p>Battery Module Lifting Tool SR-10009</p>
 <p style="text-align: center;">ST2097-A</p>	<p>Battery Post Torque Wrench 307-026</p>

---

**REMOVAL AND INSTALLATION (Continued)****Removal**

1. Remove the contactor box. Refer to [Contactor Box](#).
2.  **WARNING: The nominal voltage of the traction battery is 312 volts. The buffer zone must be set up and insulated rubber gloves and a face shield must be worn. Failure to follow these precautions may result in severe personal injury or death.**  
Observe the EV-specific precautions. Refer to [Section 100-00](#).
  - 1 Set up the buffer zone.
  - 2 Test and wear the insulated rubber gloves.
  - 3 Wear the face shield.
3. Remove battery modules 1-7.
  - Unclip and disconnect the heating element electrical connectors.
  - Remove the separator plates.
  - Remove and discard the high-voltage jumper retaining nuts.
  - Use the Battery Module Lifting Tool to remove the battery modules.
4. Replace the faulty battery module(s). Refer to [Traction Battery Module Replacement](#).

**Installation**

1. The battery module replacement procedure also contains the battery module installation.
2. Install battery modules 1-7.
  - Use the Battery Module Lifting Tool to install the battery modules.
  - Install and tighten new battery module nuts using the Battery Post Torque Wrench.
  - Install the separator plates.
  - Connect the heating element connectors.
  - Clip the connectors into the separator plate.

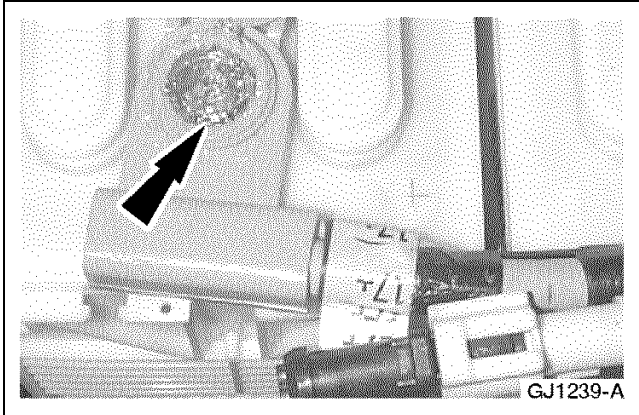
**REMOVAL AND INSTALLATION (Continued)**

3. Fill the area around the high-voltage jumper nuts with Nyogel.

4. Install the contactor box. Refer to [Contactor Box](#).

---



**Traction Battery Module — Modules 12-15, 28-31****Removal**

1. The battery modules are located in the lower center section of the traction battery and have no other battery modules above them. Replace the faulty battery modules. Refer to [Traction Battery Module Replacement](#).

**Installation**

1. The battery module replacement procedure also contains the battery module installation.
-

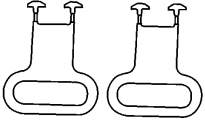
**REMOVAL AND INSTALLATION (Continued)****Traction Battery Module —Modules 16, 25-27****Special Tool(s)**

 <p>ST2095-A</p>	<p>Battery Module Lifting Tool SR-10009</p>
 <p>ST2097-A</p>	<p>Battery Post Torque Wrench 307-026</p>

**Removal**

1.  **WARNING: The nominal voltage of the traction battery is 312 volts. The buffer zone must be set up and insulated rubber gloves and a face shield must be worn. Failure to follow these precautions may result in severe personal injury or death.**  
Observe the EV-specific precautions. Refer to [Section 100-00](#).
  - 1 Set up the buffer zone.
  - 2 Test and wear the insulated rubber gloves.
  - 3 Wear the face shield.
2. Remove battery modules 17-18.
  - Unclip and disconnect the heating element electrical connectors.
  - Remove the separator plates.
  - Remove and discard the high-voltage jumper retaining nuts.
  - Use the Battery Module Lifting Tool to remove the battery modules.
3. Replace the faulty battery module(s). Refer to [Traction Battery Module Replacement](#).

**REMOVAL AND INSTALLATION (Continued)**

**Installation**

1. The battery module replacement procedure also contains the battery module installation.
  
2. Install battery modules 17-18.
  - Use the Battery Module Lifting Tool to install the battery modules.
  - Install and tighten new battery module nuts using the Battery Post Torque Wrench.
  - Install the separator plates.
  - Connect the heating element connectors.
  - Clip the connectors into the separator plate.
  
3. Fill the area around the high-voltage jumper nuts with Nyogel.

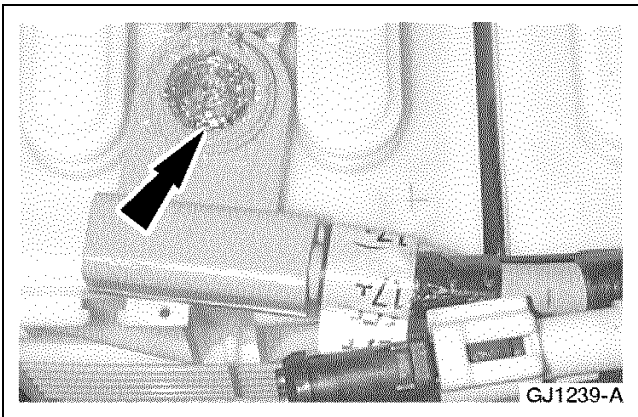

**Traction Battery Module —Modules 22-24**

**Special Tool(s)**

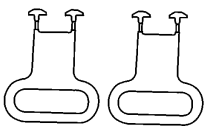
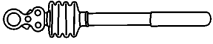
 <p style="text-align: center;">ST2095-A</p>	<p>Battery Module Lifting Tool SR-10009</p>
 <p style="text-align: center;">ST2097-A</p>	<p>Battery Post Torque Wrench 307-026</p>

---

**REMOVAL AND INSTALLATION (Continued)****Removal**

1. Remove the battery control module (BCM). Refer to [Battery Control Module \(BCM\)](#).
2.  **WARNING: The nominal voltage of the traction battery is 312 volts. The buffer zone must be set up and insulated rubber gloves and a face shield must be worn. Failure to follow these precautions may result in severe personal injury or death.**  
Observe the EV-specific precautions. Refer to [Section 100-00](#).
  - 1 Set up the buffer zone.
  - 2 Test and wear the insulated rubber gloves.
  - 3 Wear the face shield.
3. Remove battery modules 17-21.
  - Unclip and disconnect the heating element electrical connectors.
  - Remove the separator plates.
  - Remove and discard the high-voltage jumper retaining nuts.
  - Use the Battery Module Lifting Tool to remove the battery modules.
4. Replace the faulty battery module(s). Refer to [Traction Battery Module Replacement](#).

**Installation**

1. The battery module replacement procedure contains the battery module installation.
2. Install battery modules 17-21.
  - Use the Battery Module Lifting Tool to install the battery modules.
  - Install and tighten new battery module nuts using the Battery Post Torque Wrench.
  - Install the separator plates.
  - Connect the heating element connectors.
  - Clip the connectors into the separator plate.

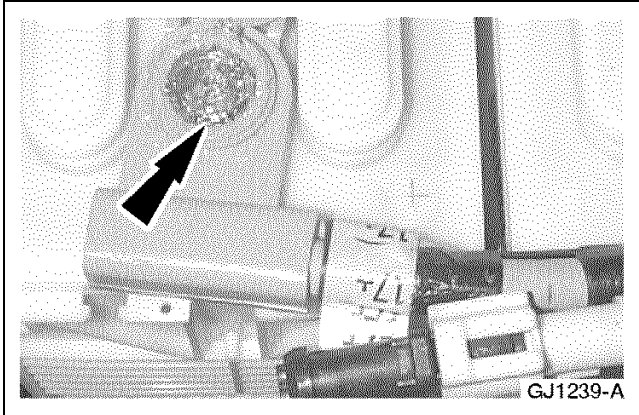

**REMOVAL AND INSTALLATION (Continued)**

3. Fill the area around the high-voltage jumper nuts with Nyogel.

4. Install the BCM. Refer to [Battery Control Module \(BCM\)](#).

---

**Traction Battery Temperature Sensor —Modules 22-24****Removal**

1. The #1 temperature sensor is located on the negative side of the #17 traction battery module. To remove the temperature sensor, remove traction battery module #17. Refer to Traction Battery Module —Modules17-18.
2. The #2 temperature sensor is located on the negative side of the #6 traction battery module. To remove the temperature sensor, remove traction battery module #6. Refer to Traction Battery Module —Modules17-18.
3. The #3 temperature sensor is located on the positive side of the #26 traction battery module. To remove the temperature sensor, remove traction battery module #26. Refer to Traction Battery Module —Modules 16, 25-27.
4. The #4 temperature sensor is located on the positive side of the #31 traction battery module. To remove the temperature sensor, remove traction battery module #31. Refer to Traction Battery Module —Modules 12-15, 28-31.

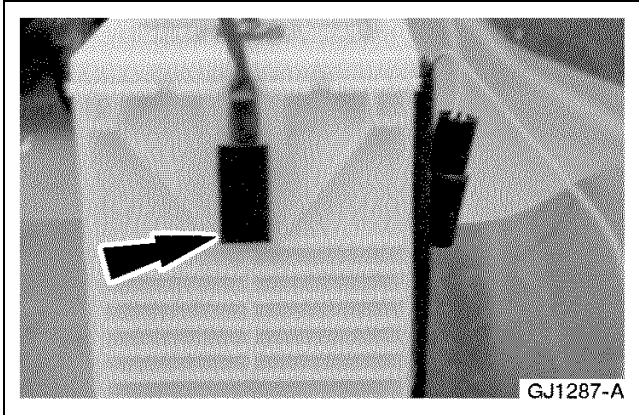
**REMOVAL AND INSTALLATION (Continued)**

5.  **CAUTION: Do not use excessive force to remove the temperature sensor or damage to the battery module may occur.**

**NOTE:** If the sensor is difficult to remove, warm it using a heat gun. Be careful not to overheat the sensor or the battery module, or damage to both may occur.

Remove the temperature sensor.

- Pull the bottom of the temperature sensor from the battery module and remove the sensor.

**Installation**

1. Apply a thin coat of thermal grease to the back of the thermistor.
2. The traction battery temperature sensors are mounted on the side of the battery modules. To install the temperature sensors, reverse the removal procedure for the battery module on which the sensor is located. Refer to the appropriate Traction Battery Module procedure.

## DISASSEMBLY AND ASSEMBLY

### Traction Battery Temperature Sensor

#### Special Tool(s)

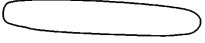
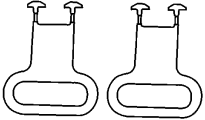
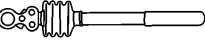
 <p>ST2091-A</p>	Battery Terminal Cap Opener 418-F215
 <p>ST2095-A</p>	Battery Module Lifting Tool 418-F206
 <p>ST2097-A</p>	Battery Post Torque Wrench 307-026

**DISASSEMBLY AND ASSEMBLY (Continued)**

Traction Battery LH View

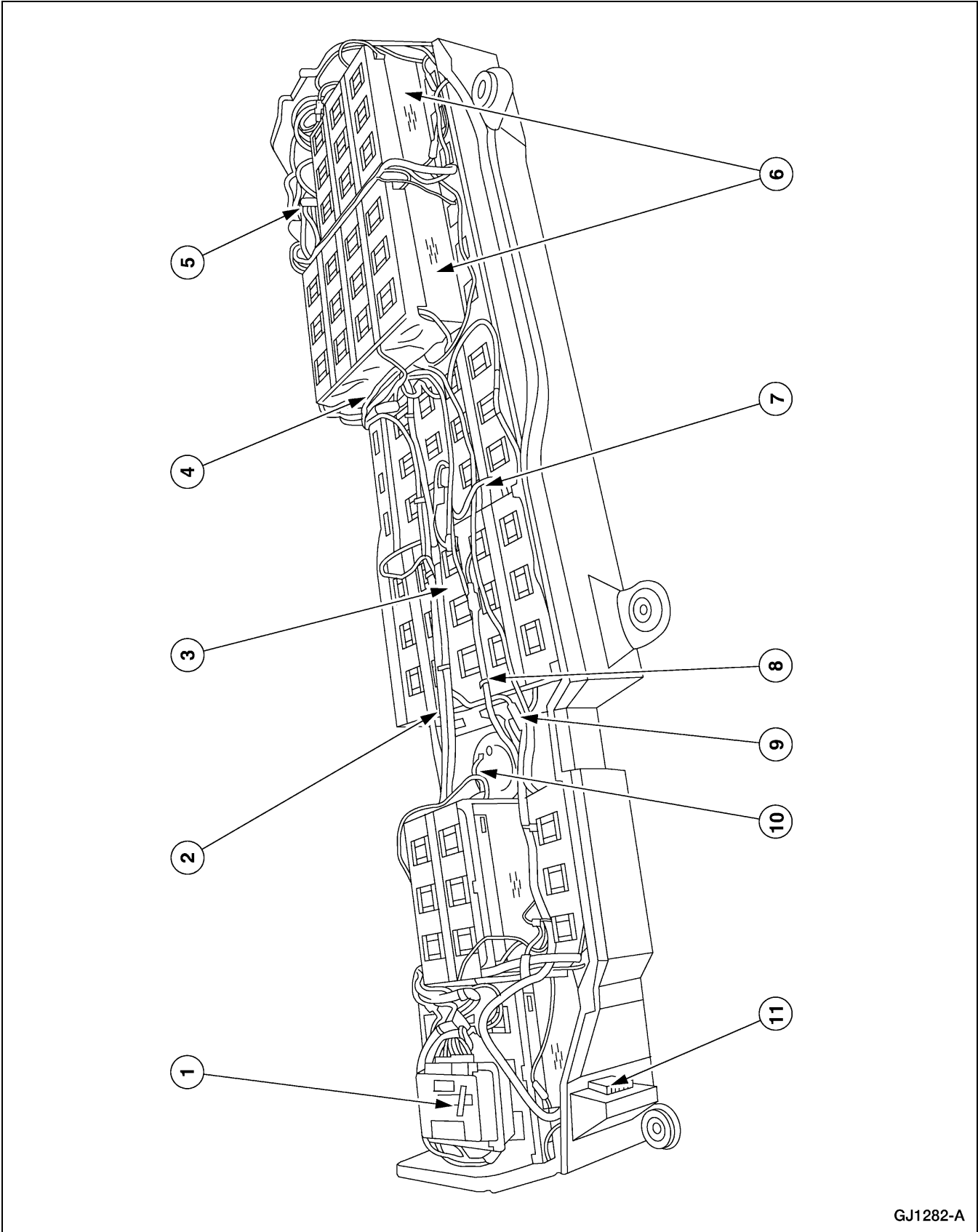

GJ1282-A

**DISASSEMBLY AND ASSEMBLY (Continued)**

<b>Item</b>	<b>Description</b>
1	Battery Control Module (BCM)
2	Contactora Box Harness
3	High-Voltage (Sensor Lead) Harness (10B694)
4	Upper Level Battery Module
5	Contactora Box

(Continued)

<b>Item</b>	<b>Description</b>
6	Upper Level Heating Elements
7	Separator Plate
8	Low-Voltage Harness
9	Traction Battery Cooling Fan Relay
10	Traction Battery Cooling Fan
11	76-Pin Connector

**DISASSEMBLY AND ASSEMBLY (Continued)**

Traction Battery RH View

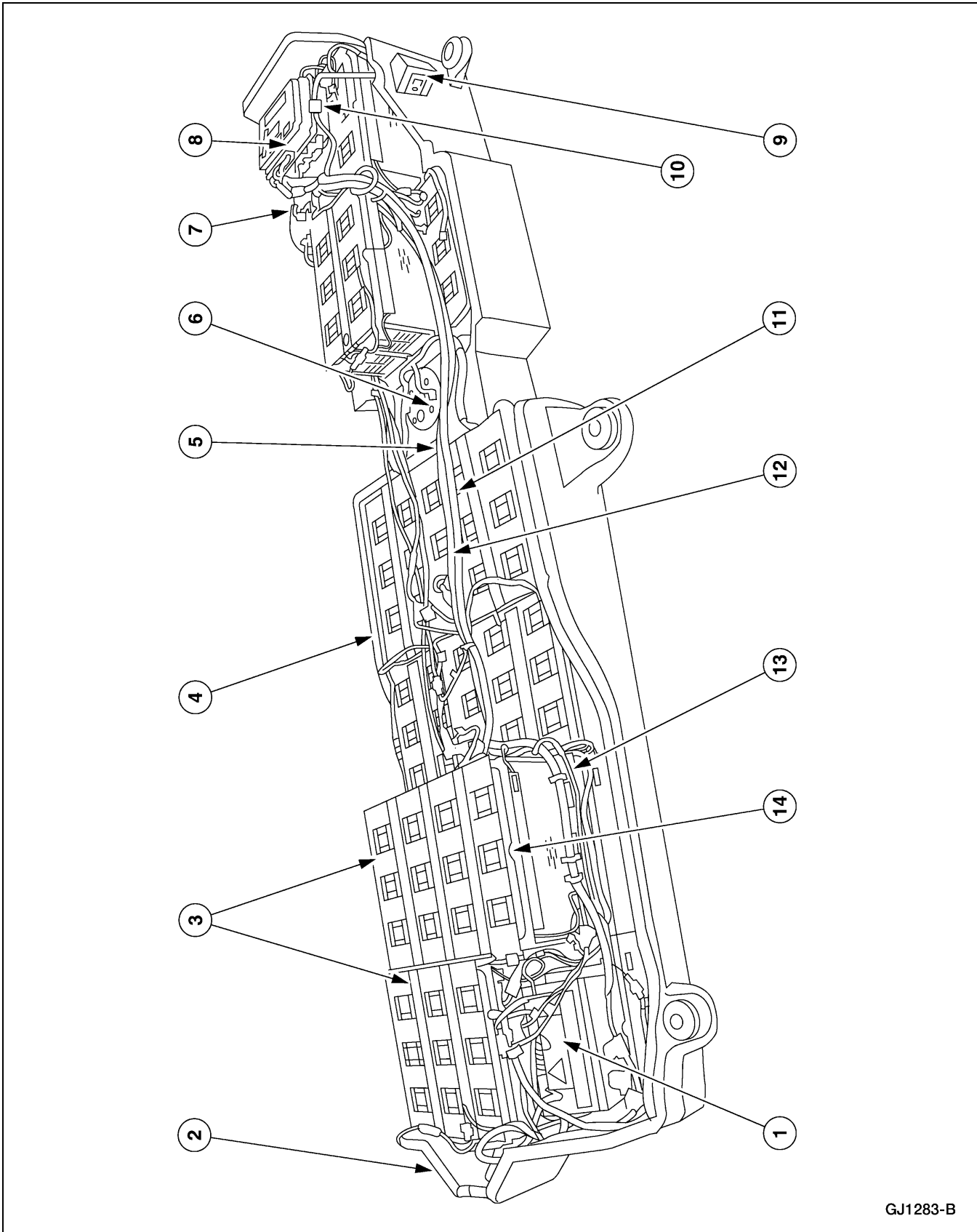

GJ1283-B

**DISASSEMBLY AND ASSEMBLY (Continued)**

Item	Description
1	Contacting Box
2	Two-Pin High-Voltage Connector
3	Separator Plates
4	Traction Battery Case
5	Traction Battery Cooling Fan Relay
6	Traction Battery Cooling Fan
7	76-Pin Connector
8	Battery Control Module (BCM)

(Continued)

Item	Description
9	High Voltage Four-Pin Auxiliary Load Connector
10	High Voltage Four-Pin Auxiliary Load Connector Bracket
11	Contacting Box Harness
12	High-Voltage (Sensor Lead) Harness (10B694)
13	Low-Voltage Harness (10B691)
14	Battery Module

**Disassembly**

1. Remove the traction battery. Refer to [Traction Battery](#).
2. Remove the traction battery cover.
  - 1 Remove the 22 bolts.
  - 2 Remove the cover.

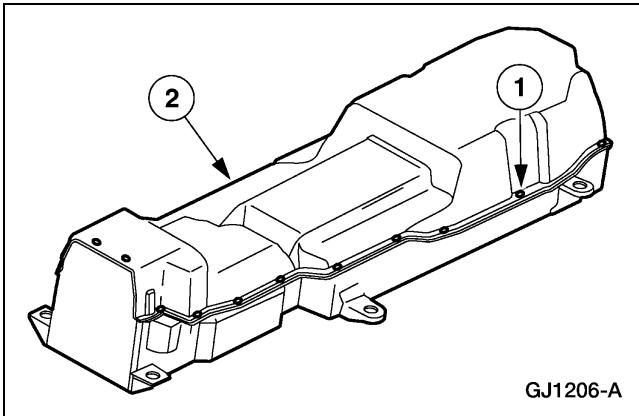

3. **⚠ WARNING: The nominal voltage of the traction battery is 312 volts. The buffer zone must be set up and insulated rubber gloves and a face shield must be worn. Failure to follow these precautions may result in severe personal injury or death.**  
Observe the EV-specific precautions. Refer to [Section 100-00](#).
  - 1 Set up the buffer zone.
  - 2 Test and wear the insulated rubber gloves.
  - 3 Wear the face shield.

## DISASSEMBLY AND ASSEMBLY (Continued)

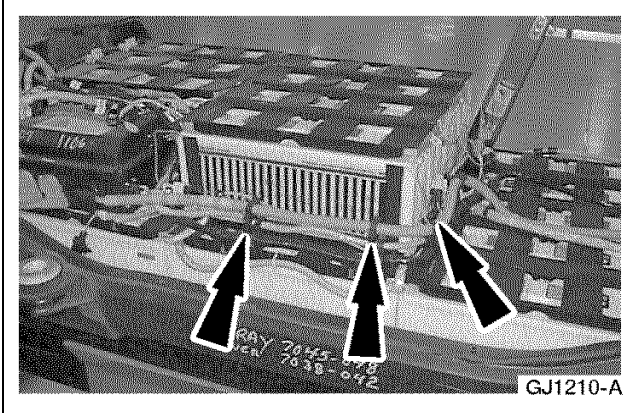

4. Unclip the low and high-voltage wiring harnesses from each other and from the separator plate.

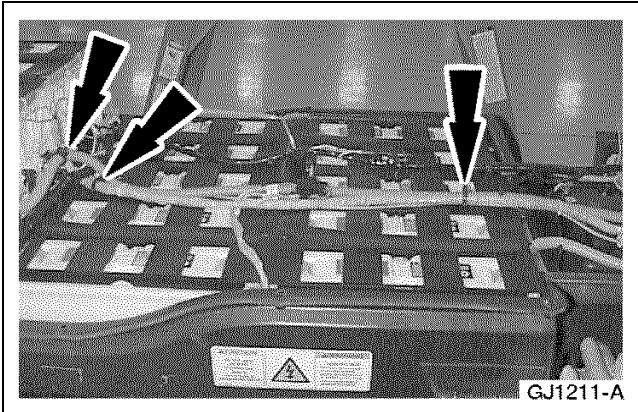

5. Unclip the low and high-voltage wiring harnesses from each other and from the separator plate.
  - Cut the zip tie.

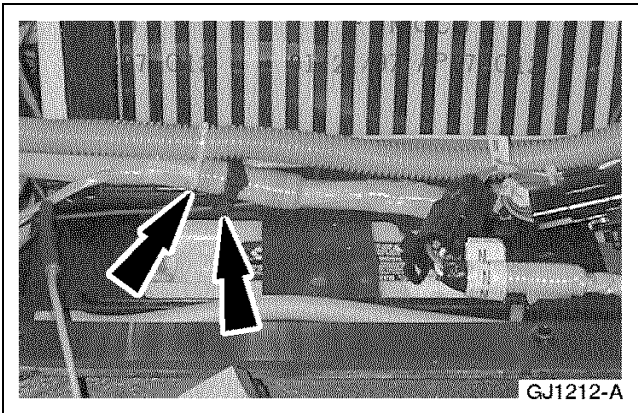

6. Unclip the low and high-voltage wiring harnesses from each other and from the separator plate.
  - Cut the zip tie.

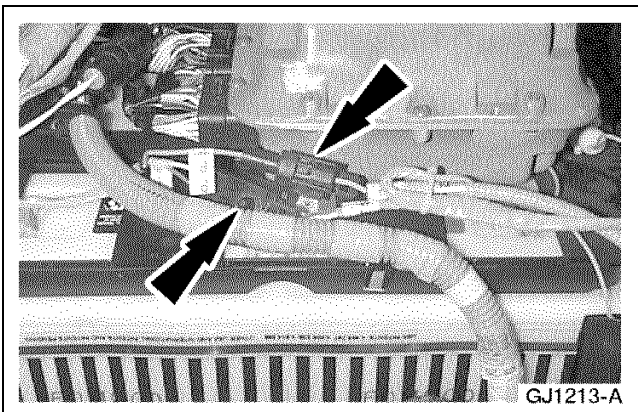

7. **NOTE:** There are 20 sense lead wiring connectors. They can be identified by a white tag with a black letter.  
Unclip and disconnect the sense lead wiring connectors.

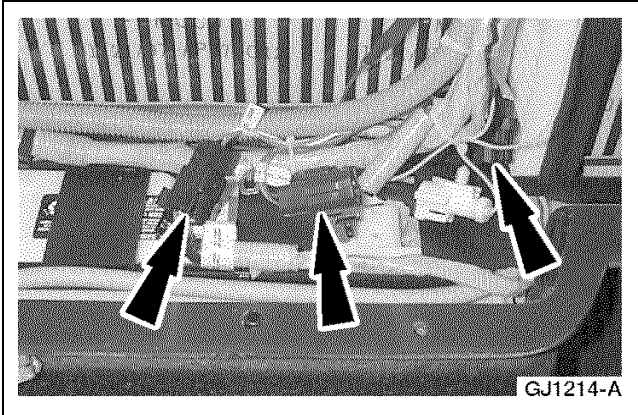

**DISASSEMBLY AND ASSEMBLY (Continued)**

8. Unclip and disconnect the sense lead wiring.

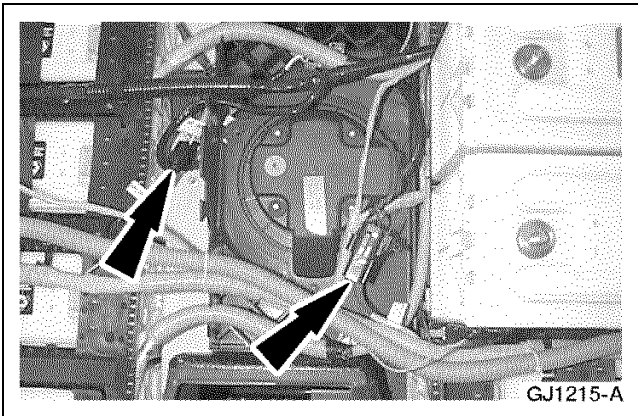

9. Unclip and disconnect the sense lead wiring.

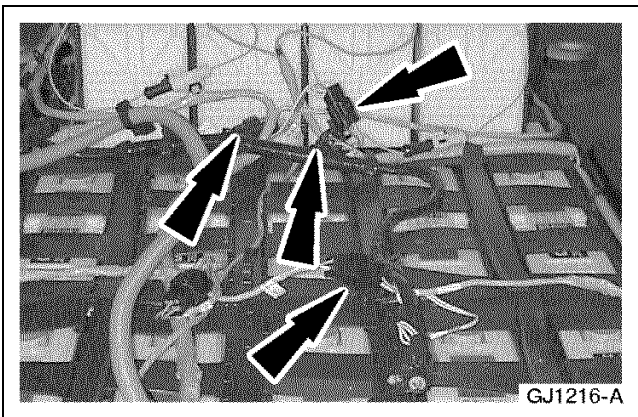

10. Unclip and disconnect the sense lead wiring.

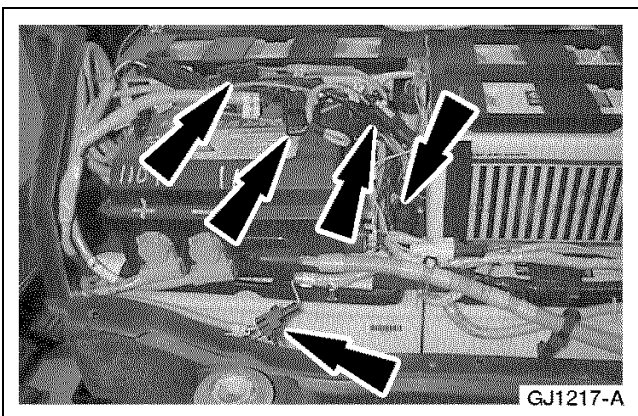

11. Unclip and disconnect the sense lead wiring.

## DISASSEMBLY AND ASSEMBLY (Continued)

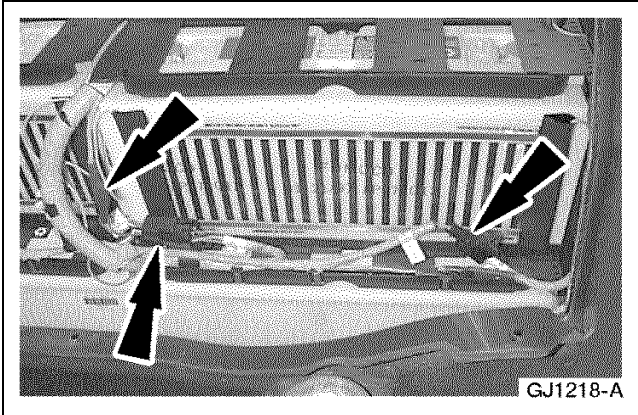

12. Unclip and disconnect the sense lead wiring.

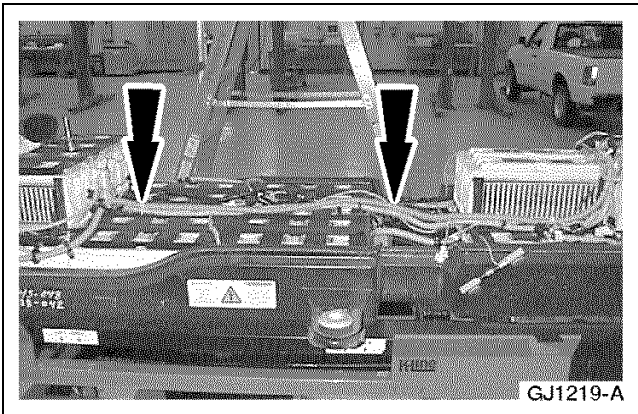

13. Cut the two zip ties from the high-voltage harness.

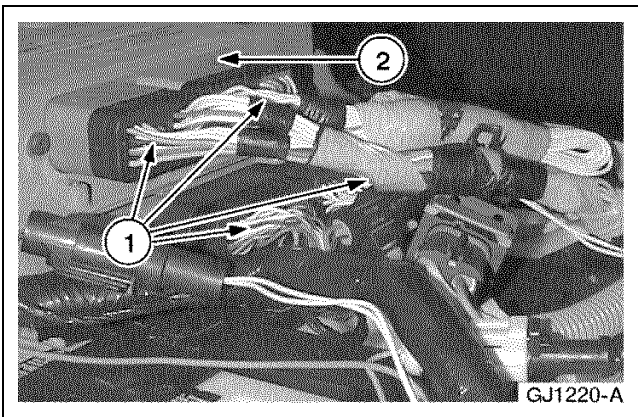

14. **NOTE:** The battery control module (BCM) is held in position with strips of Velcro™.

Remove the BCM.

- 1 Loosen the four bolts and disconnect the four multi-pin connectors from the BCM.
- 2 Remove the BCM.

15. **NOTE:** The high-voltage harness is wrapped with orange tape and runs from the contactor box to the BCM.

Remove the high-voltage harness.

## DISASSEMBLY AND ASSEMBLY (Continued)

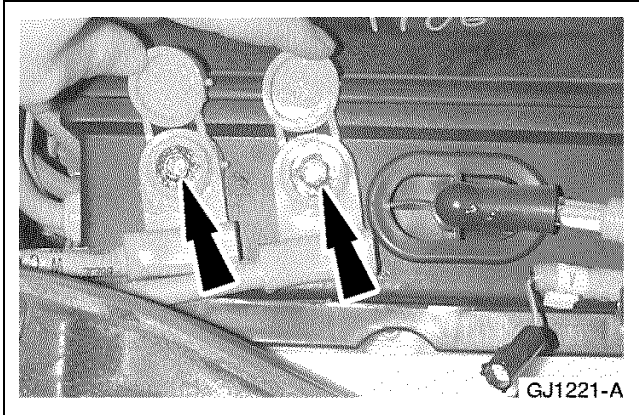

16. **⚠ CAUTION: Do not allow the high voltage jumper (HVJ) ends to contact one another. The ends of the HVJs must be wrapped with orange electrical tape to prevent them from contacting one another.** Disconnect the HVJs from the contactor box, one at a time.
- Use the Battery Terminal Cap Opener to open the battery module caps.
  - Remove the two bolts.
  - Wrap the HVJs with orange electrical tape to prevent contact.

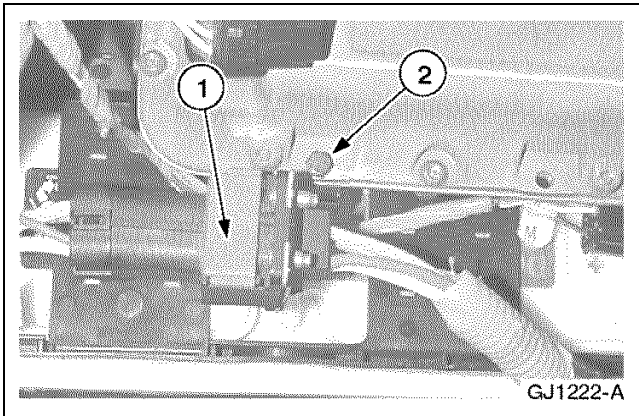

17. Disconnect the contactor box harness.
- 1 Disconnect the harness.
  - 2 Remove the bracket bolt.

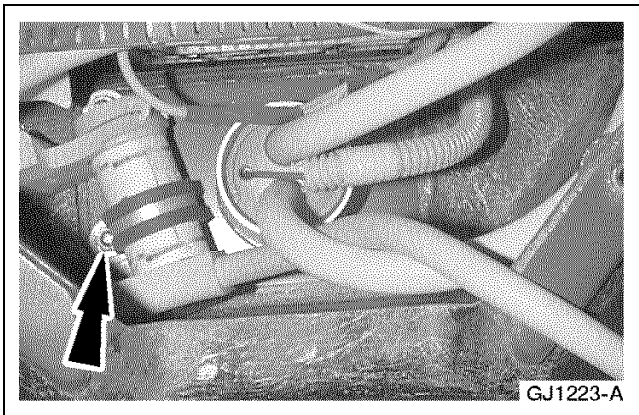

18. Remove the fuse nut.

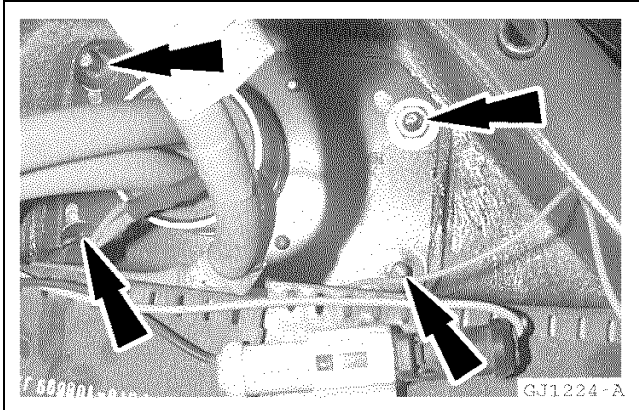

19. Remove the four high-voltage traction battery two-pin connector retaining nuts.

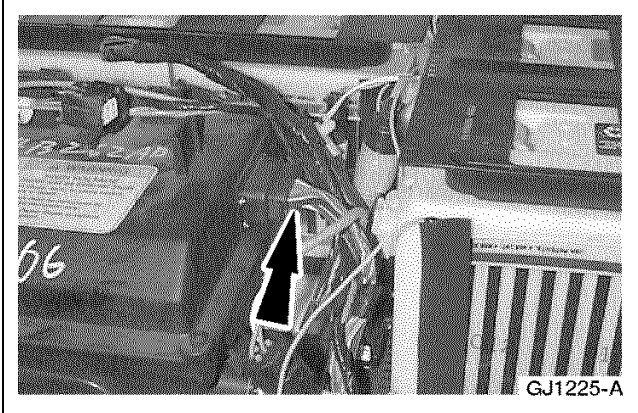
**DISASSEMBLY AND ASSEMBLY (Continued)**

20. Disconnect the low-voltage harness from the contactor box.

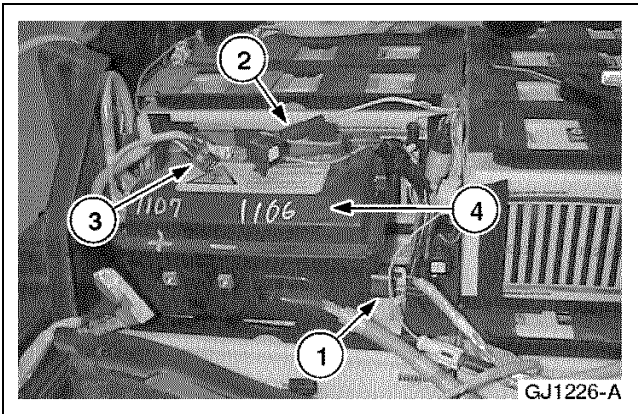

21. Remove the contactor box.
- 1 Unclip the heating element connector.
  - 2 Unclip the temperature sensor connector.
  - 3 Unclip and disconnect the traction battery high-voltage two-pin connector.
  - 4 Remove the contactor box.

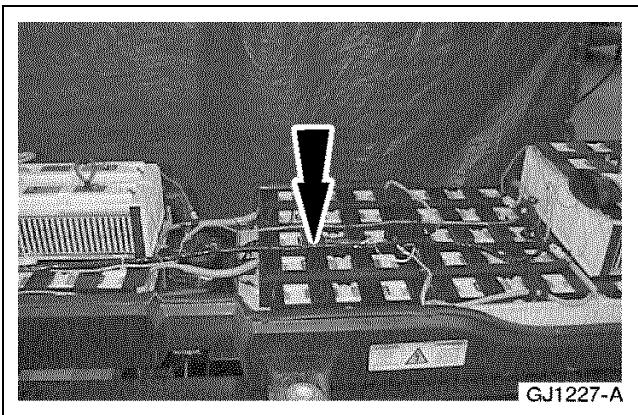

22. Unclip the low-voltage harness from the separator plates.
- Cut the two zip ties.

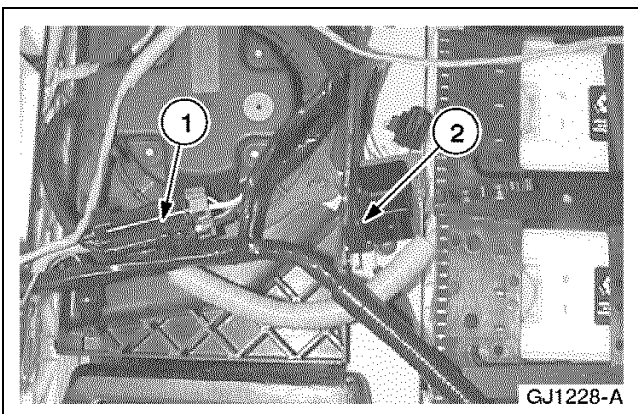

23. Disconnect the cooling fan.
- 1 Disconnect the electrical connector.
  - 2 Remove the relay screw.

## DISASSEMBLY AND ASSEMBLY (Continued)

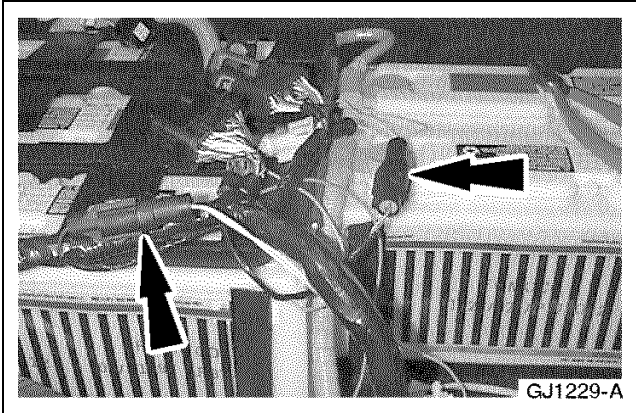

24. Disconnect the two temperature sensors.

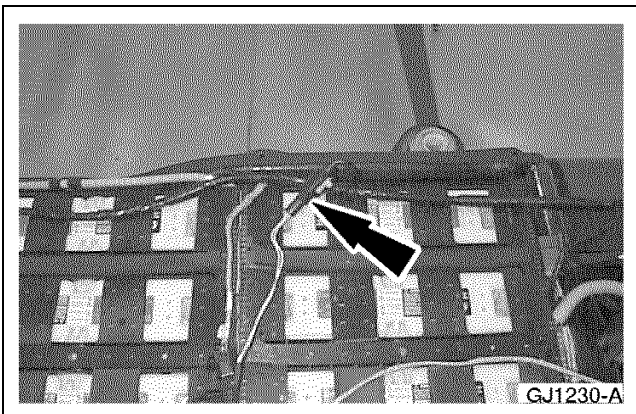

25. Disconnect the temperature sensor.



26. Disconnect the temperature sensor.

27. **NOTE:** The low-voltage harness remains connected to the traction battery at the 76-pin connector.

Remove the low-voltage harness from the traction battery and position the harness aside.

28. Disconnect all remaining connectors that are clipped into the separator plate.

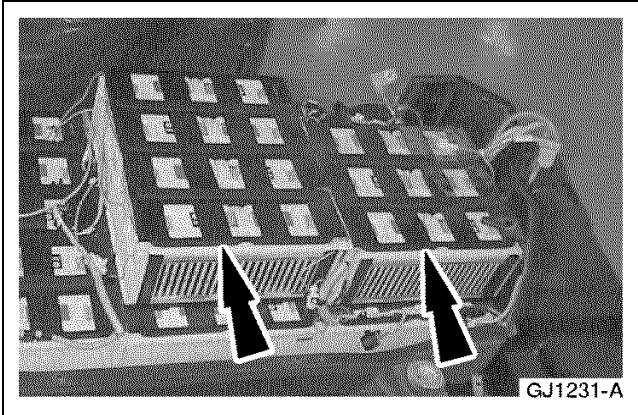
**DISASSEMBLY AND ASSEMBLY (Continued)**

29. Remove the separator plate.

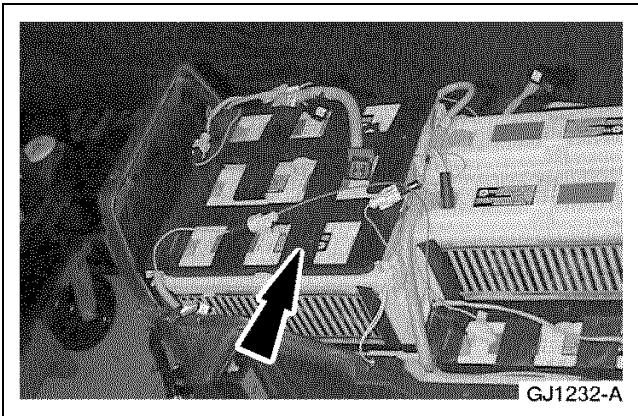

30. Remove the separator plates.

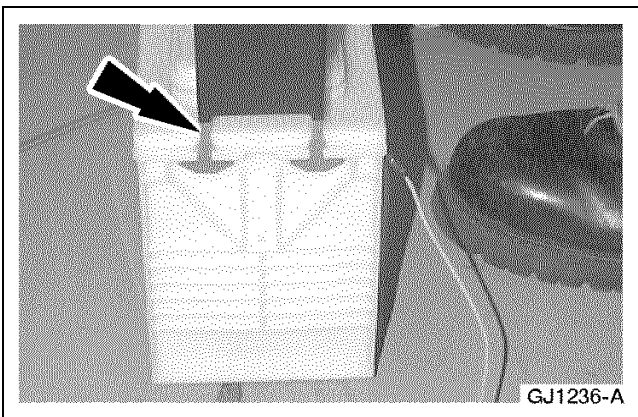

31. Remove all of the upper level battery module HVJs and discard the nuts.

- Use the Battery Terminal Cap Opener to open the battery module caps.

32. Use Battery Module Lifting Tool to remove all of the upper-level battery modules.

- 1 Use one tool on each side of the battery modules to lift them from the pack.

## DISASSEMBLY AND ASSEMBLY (Continued)

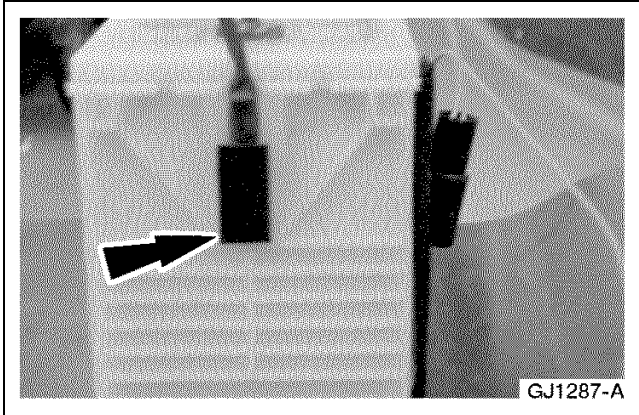

33.  **CAUTION: Do not use excessive force to remove the temperature sensor, or damage to the module may occur.**

**NOTE:** If the sensor is difficult to remove, warm it using a heat gun. Be careful not to overheat the sensor or the battery module, or damage to both may occur.

Remove the temperature sensors that are attached to the two upper battery modules.

- Pull the bottom of the temperature sensor from the battery module and remove the sensor.

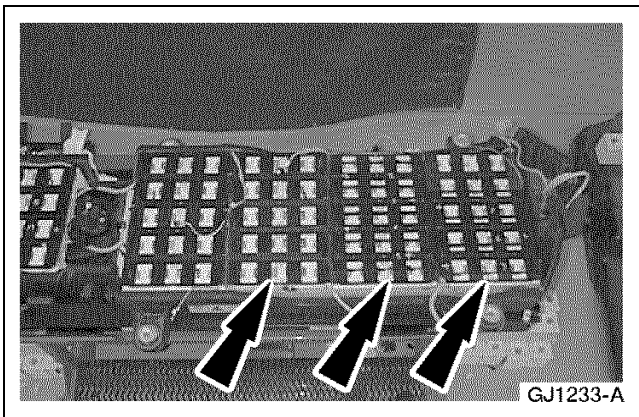

34. Remove the lower separator plates.

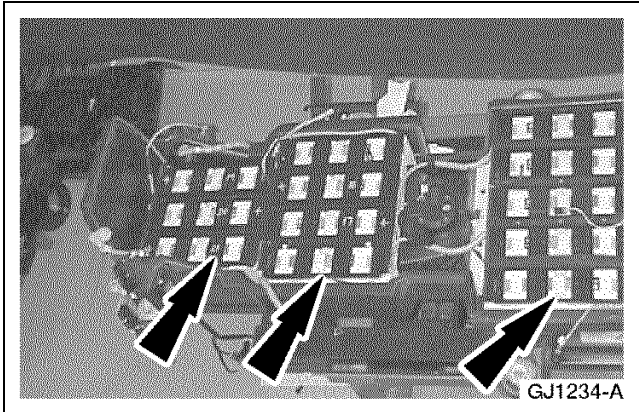

35. Remove the lower separator plates.

36. Remove all of the lower level battery module HVJs and discard the nuts.

- Use the Battery Terminal Cap Opener to open the battery module caps.

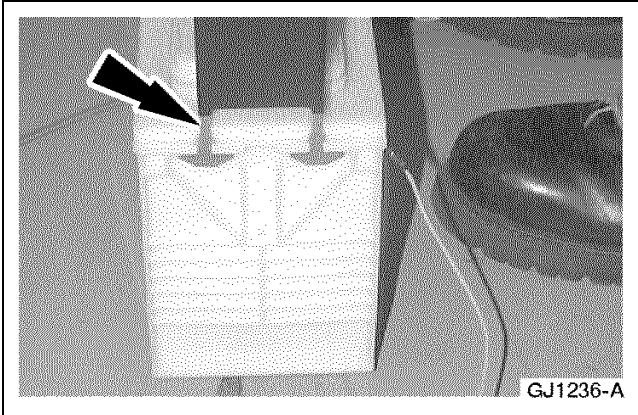
**DISASSEMBLY AND ASSEMBLY (Continued)**

37. Use Battery Module Lifting Tool to remove all of the lower level battery modules.

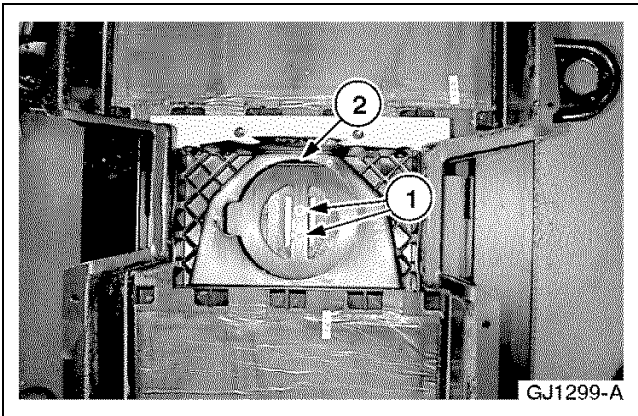

38. Remove the cross bar/blower bracket.
- 1 Remove the two nuts.
  - 2 Remove the cross bar/blower bracket.

39. Remove the lower heating blanket and clean any debris from the traction battery tray.



## DISASSEMBLY AND ASSEMBLY (Continued)

## Assembly

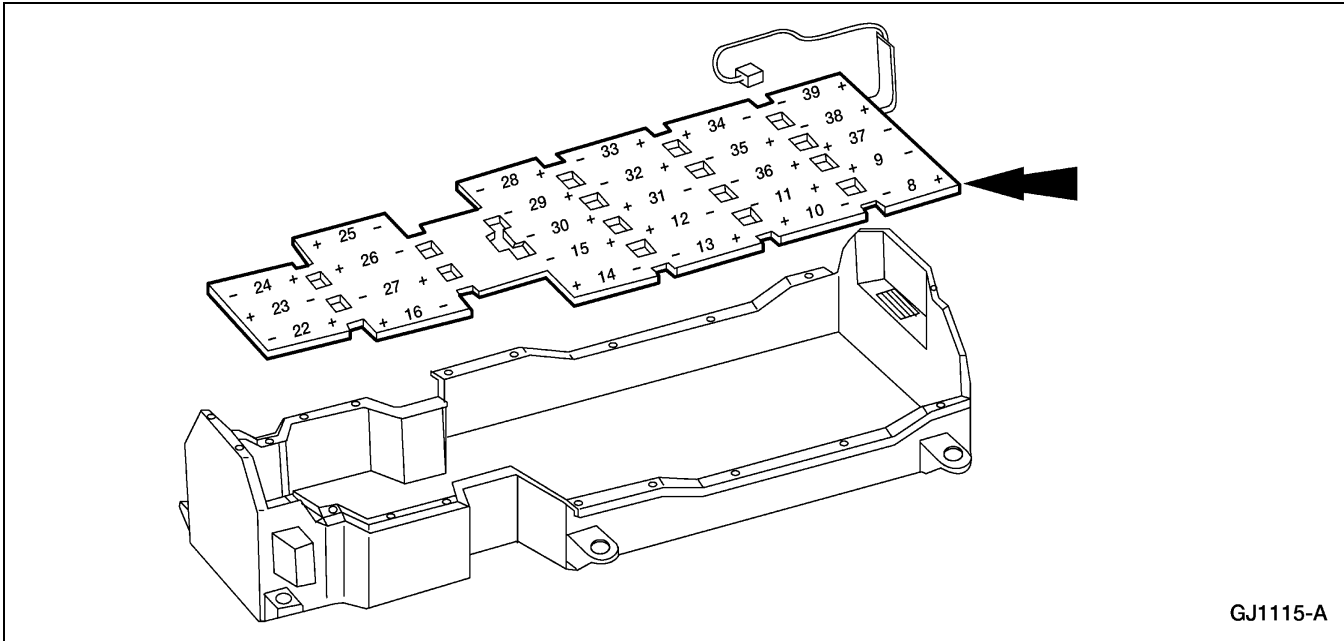

1. Position the lower heating element in the bottom of the battery tray and apply the battery module numbers to the blanket as illustrated.

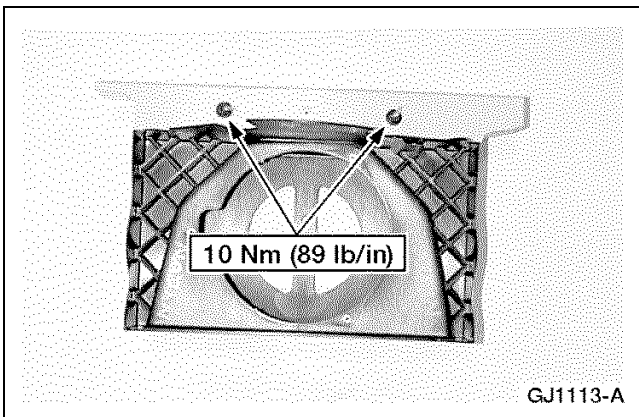

2. **NOTE:** This step only applies to initial traction battery build-up. These components were not separated during the disassembly procedure. Connect the cross bar to the cooling fan bracket.
  - Install the two bolts.

## DISASSEMBLY AND ASSEMBLY (Continued)

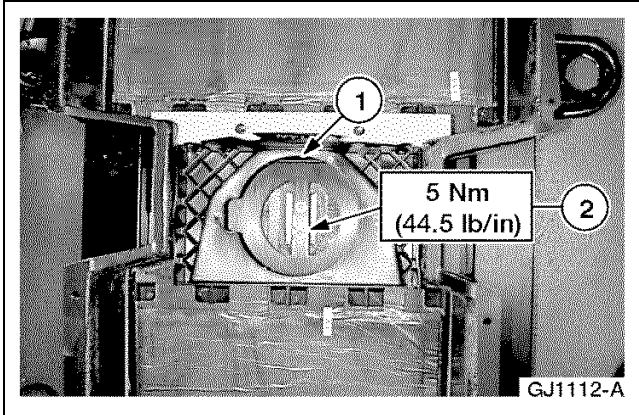

3. Install the cross bar/cooling fan bracket.
  - 1 Position the cross bar/blower bracket.
  - 2 Install the two nuts.

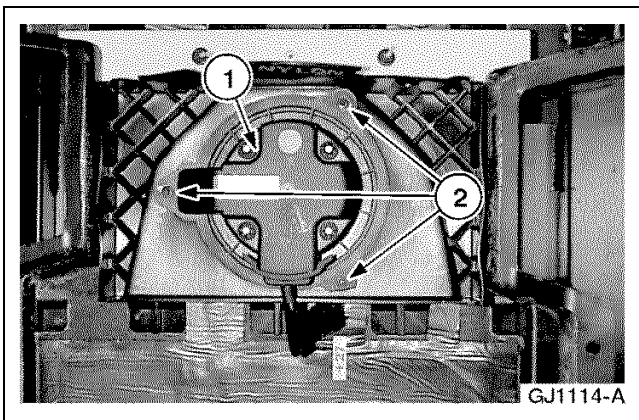

4. Install the cooling fan.
  - 1 Position the cooling fan.
  - 2 Install the three screws.

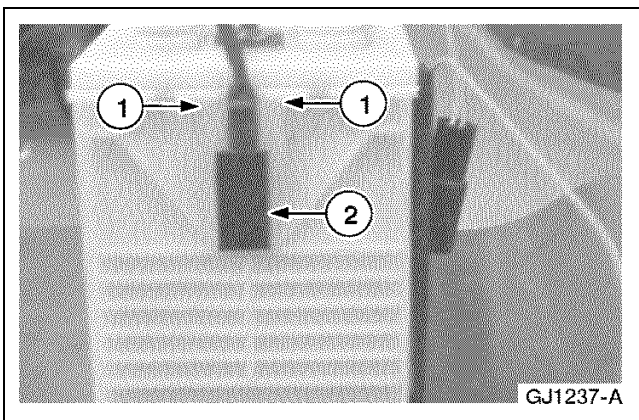

5. Use a heat gun to warm the temperature sensor prior to installation.
6. Apply a thin layer of thermal grease to the back of the thermistor.
7. **⚠ CAUTION: Do not use excessive force to install the temperature sensor, or damage to the module may occur.**

Install a temperature sensor on the + (positive) terminal side of battery modules 26 and 31.

- 1 Position the temperature sensor prongs into the holes in the battery module.
- 2 Clip the temperature sensor into the pin on the battery module.

## DISASSEMBLY AND ASSEMBLY (Continued)

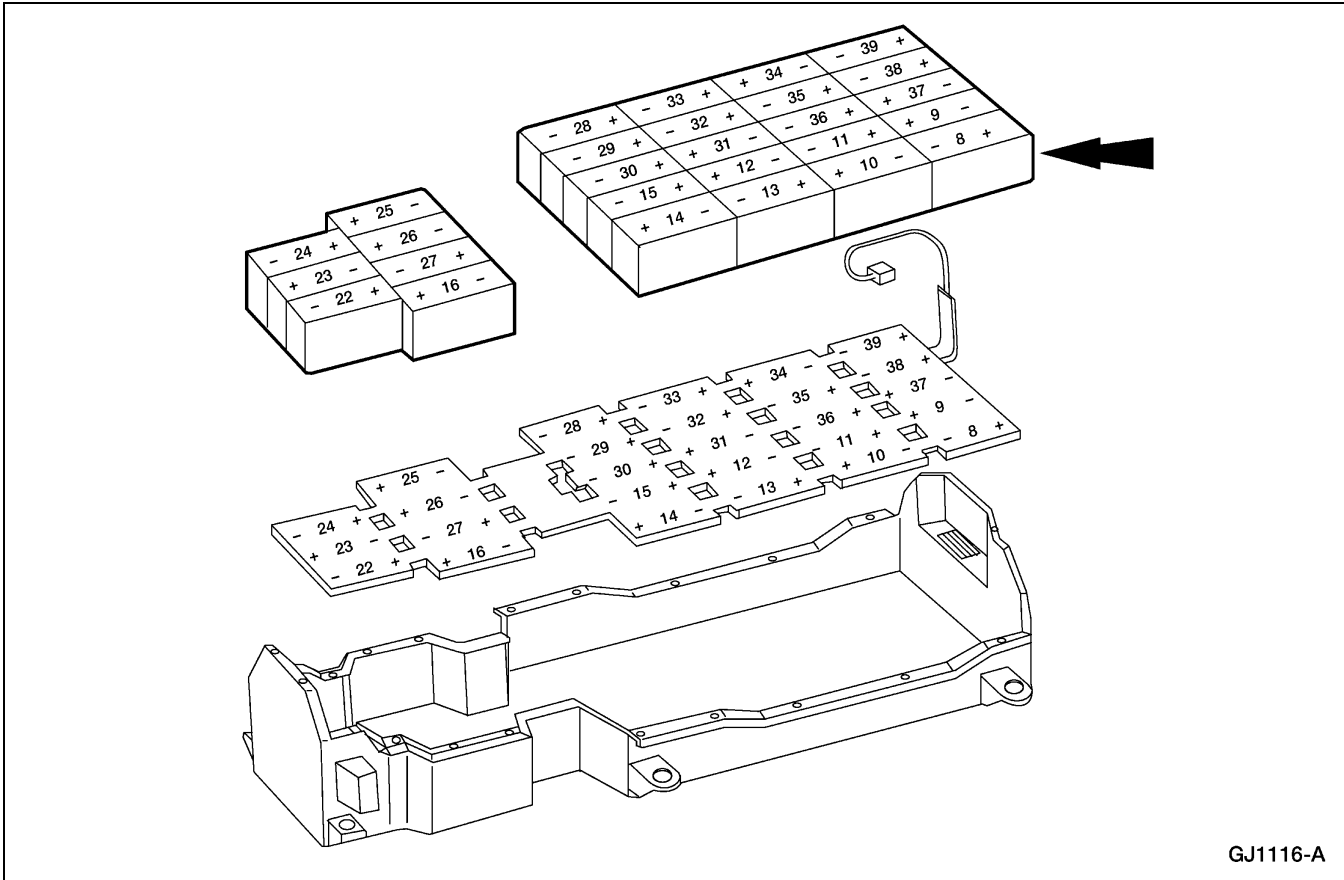

8. **NOTE:** The battery module numbers correspond to the numbers on the heating blanket.

**NOTE:** The battery modules must be installed with the terminals oriented as illustrated.

Install the 27 lower-level battery modules.

- Label the battery modules as illustrated.

**NOTE:** The high-voltage jumper (HVJ) retaining nuts are hand-tightened during initial installation.

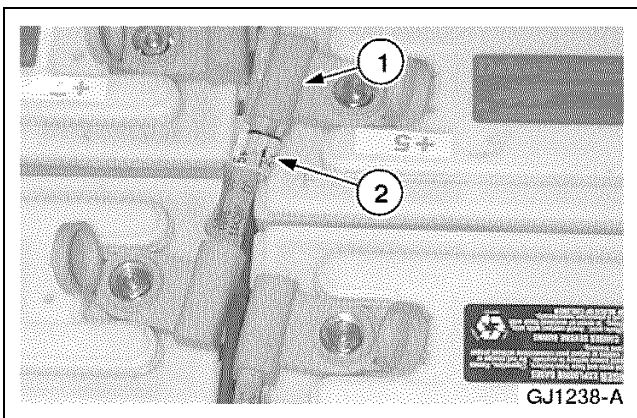

9. HVJ installation notes:

- 1 Position the HVJ cable ends parallel to the side of the battery module.
- 2 Route the sense lead wiring under the main HVJ cable.

**DISASSEMBLY AND ASSEMBLY (Continued)**

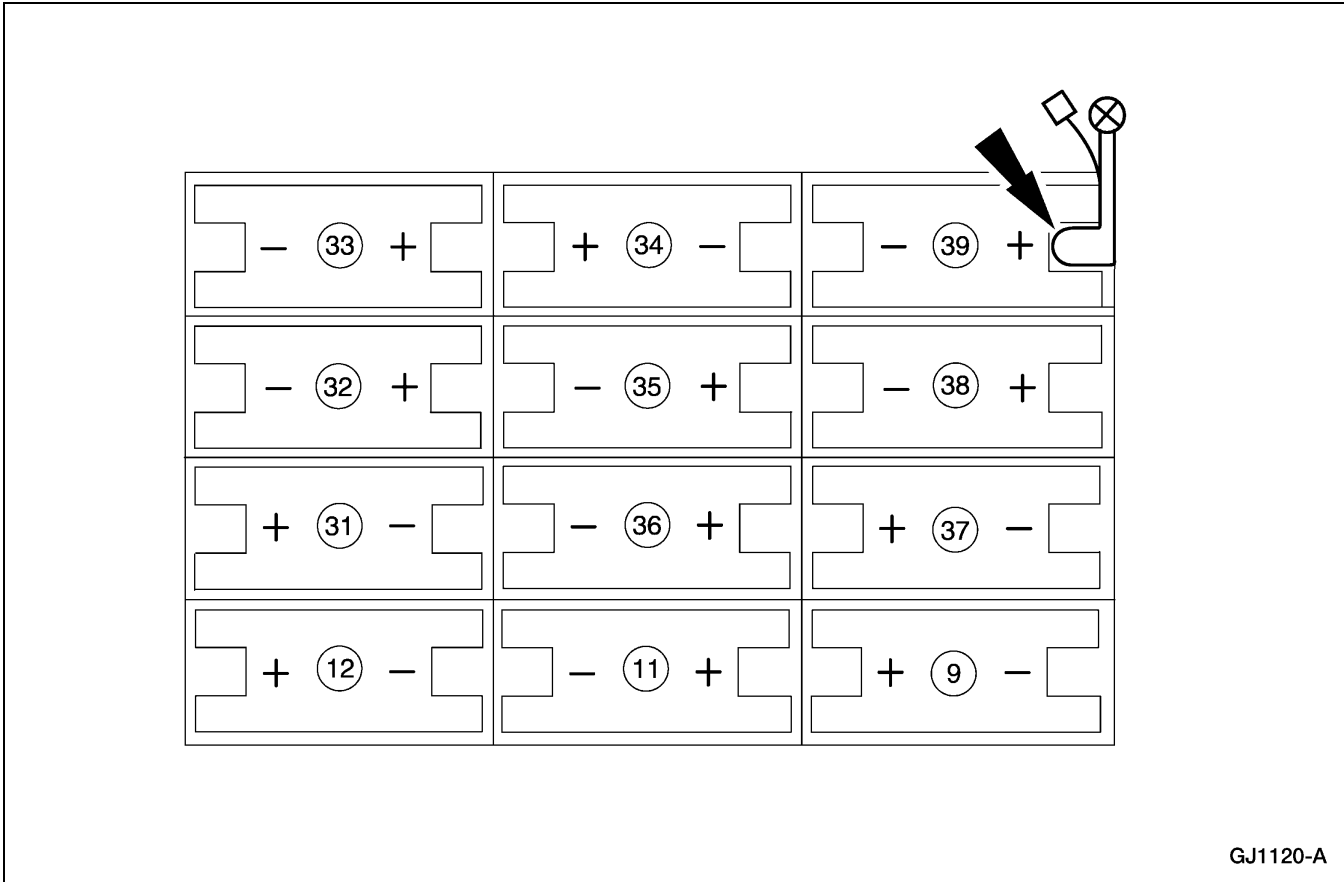

10. Install the W HVJ.
  - Install the 39+ nut.

## DISASSEMBLY AND ASSEMBLY (Continued)

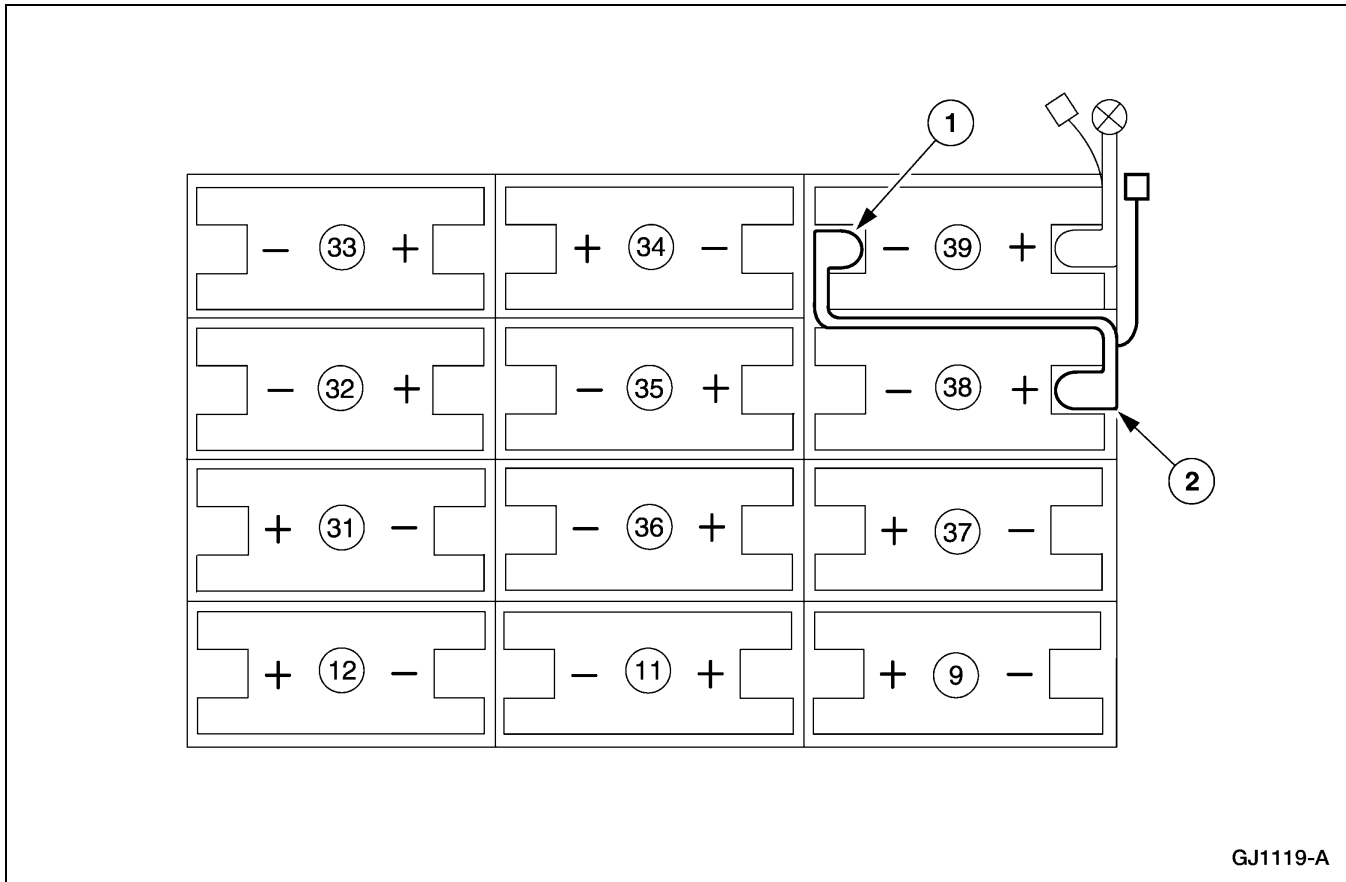

## 11. Install the V HVJ.

- 1 Install the 39 - nut.
- 2 Install the 38+ nut.

## DISASSEMBLY AND ASSEMBLY (Continued)

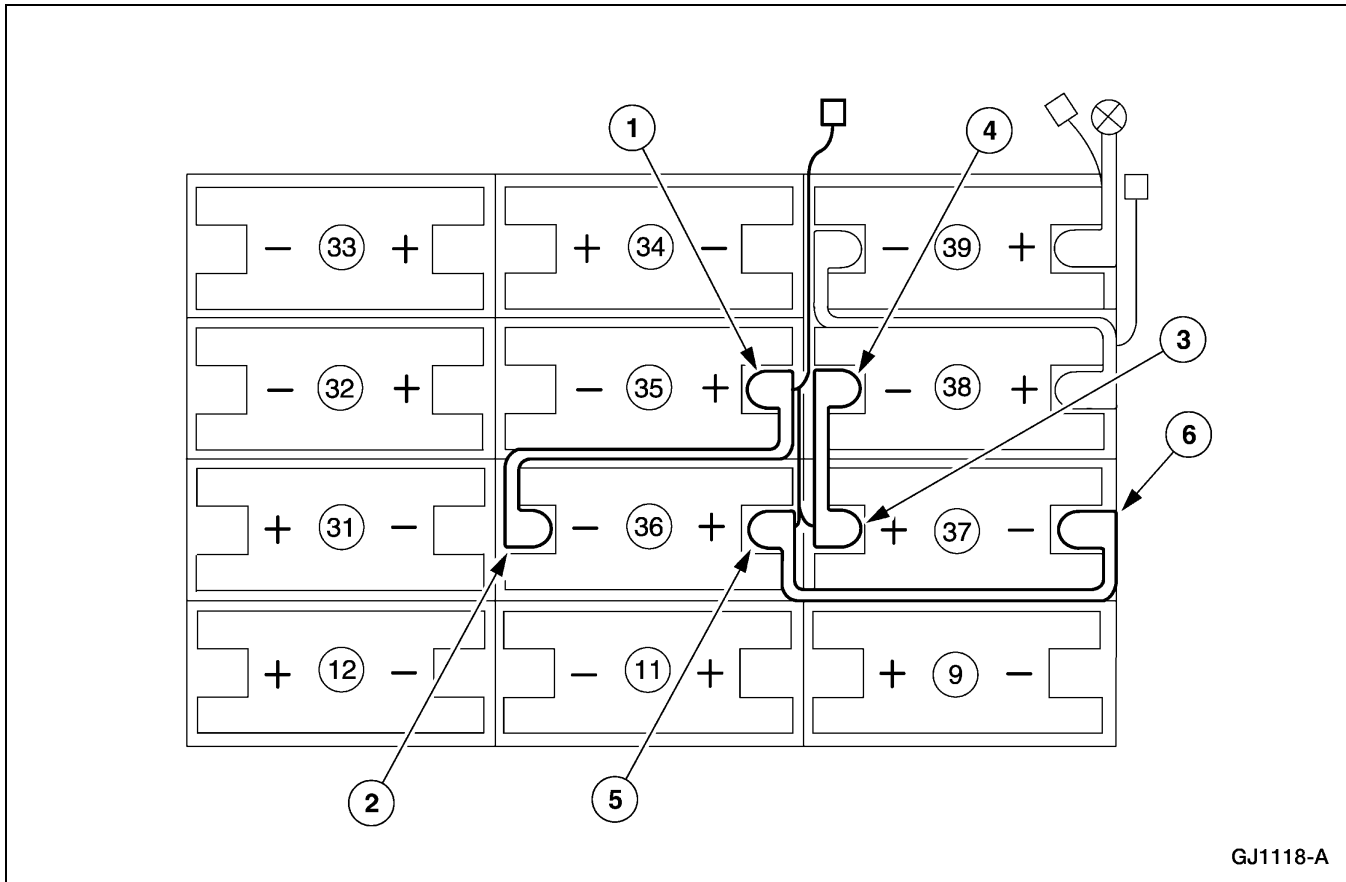

## 12. Install the U HVJ.

- 1 Install the 35+ nut.
- 2 Install the 36- nut.
- 3 Install the 37+ nut.
- 4 Install the 38- nut.
- 5 Install the 36+ nut.
- 6 Install the 37- nut.

## DISASSEMBLY AND ASSEMBLY (Continued)

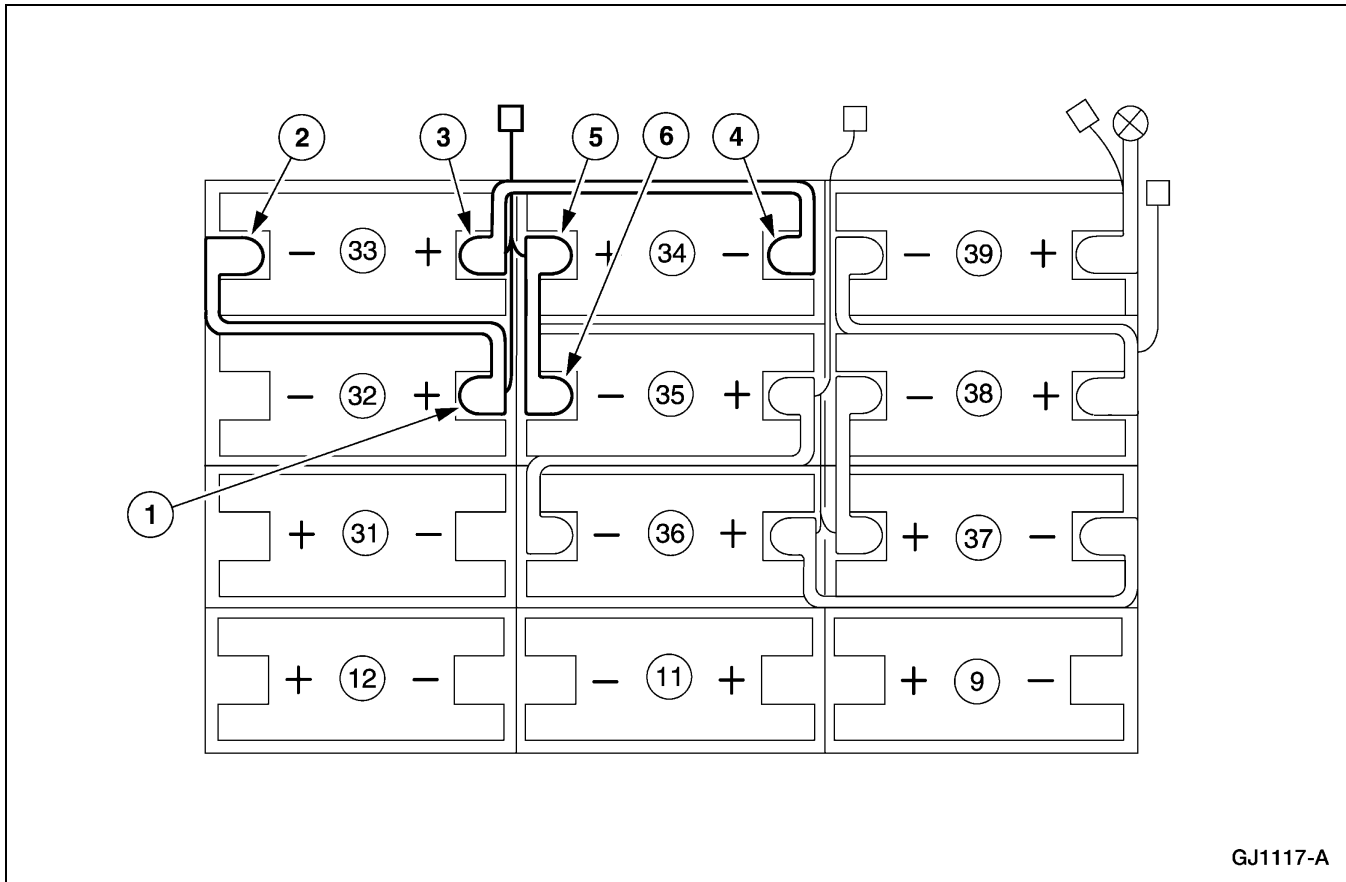

## 13. Install the T HVJ.

- 1 Install the 32+ nut.
- 2 Install the 33- nut.
- 3 Install the 33+ nut.
- 4 Install the 34- nut.
- 5 Install the 34+ nut.
- 6 Install the 35- nut.

## DISASSEMBLY AND ASSEMBLY (Continued)

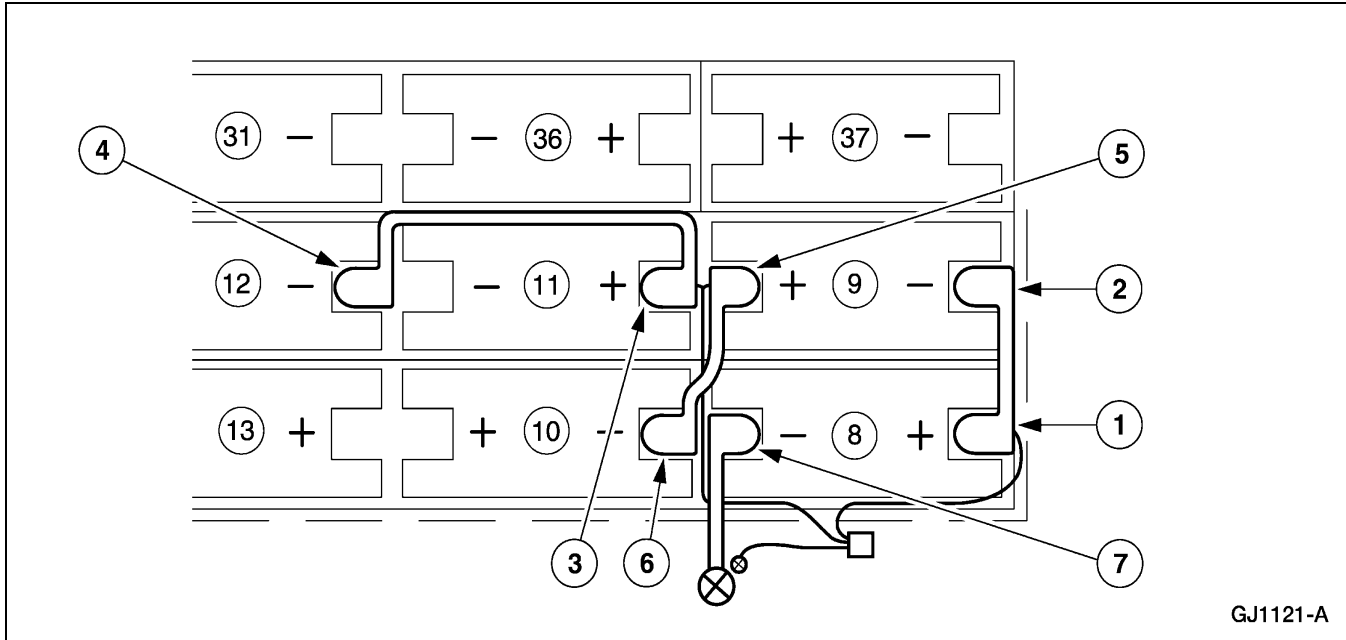

## 14. Install the G HVJ.

- 1 Install the 8+ nut.
  - 2 Install the 9- nut.
  - 3 Install the 11+ nut.
  - 4 Install the 12- nut.
  - 5 Install the 9+ nut.
  - 6 Install the 10- nut.
  - 7 Install the 8- nut.
- The remaining end is not connected at this time. Close the cap.



## DISASSEMBLY AND ASSEMBLY (Continued)

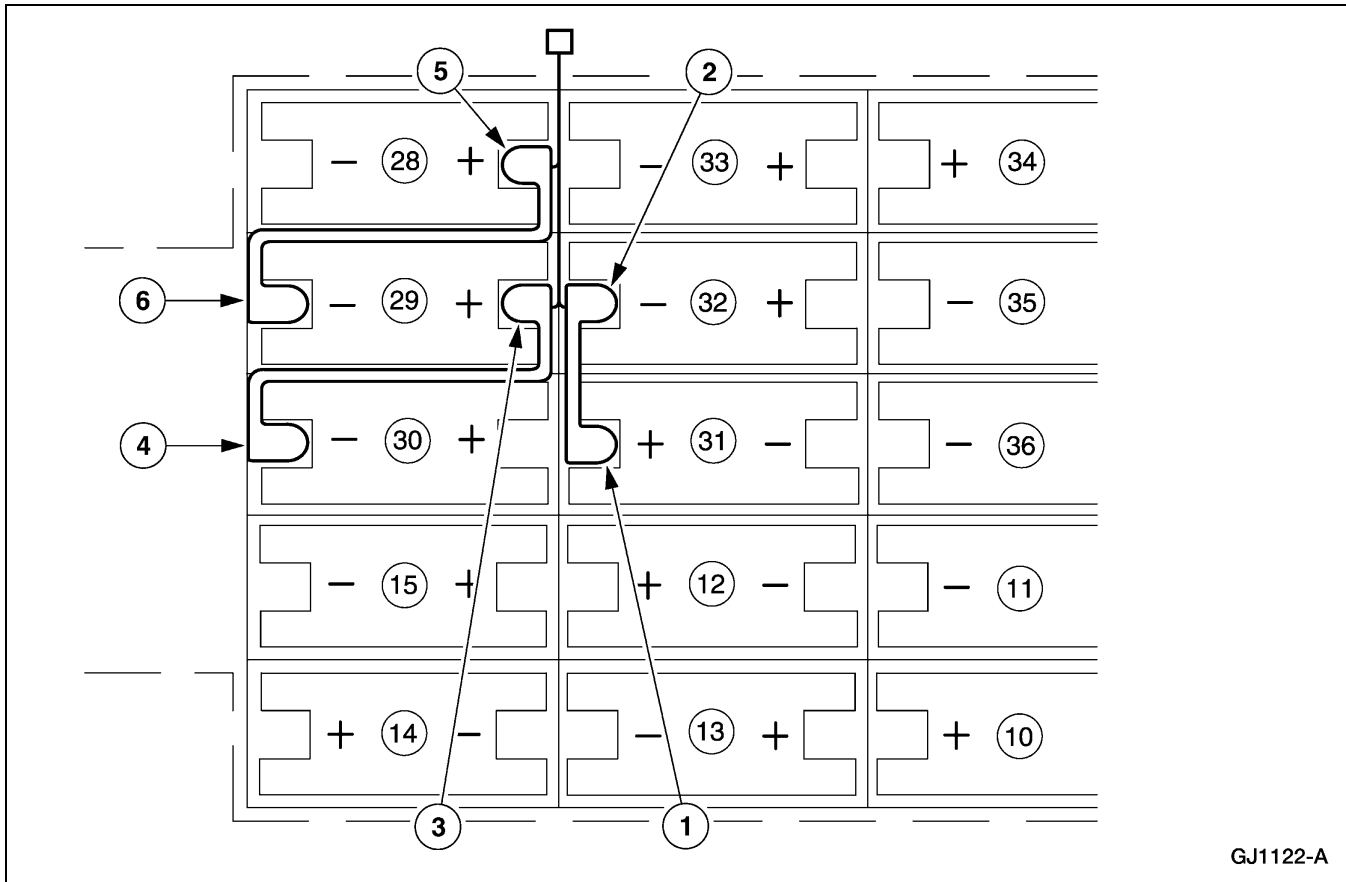

GJ1122-A

## 15. Install the S HVJ.

- 1 Install the 31+ nut.
- 2 Install the 32- nut.
- 3 Install the 29+ nut.
- 4 Install the 30- nut.
- 5 Install the 28+ nut.
- 6 Install the 29- nut.

## DISASSEMBLY AND ASSEMBLY (Continued)

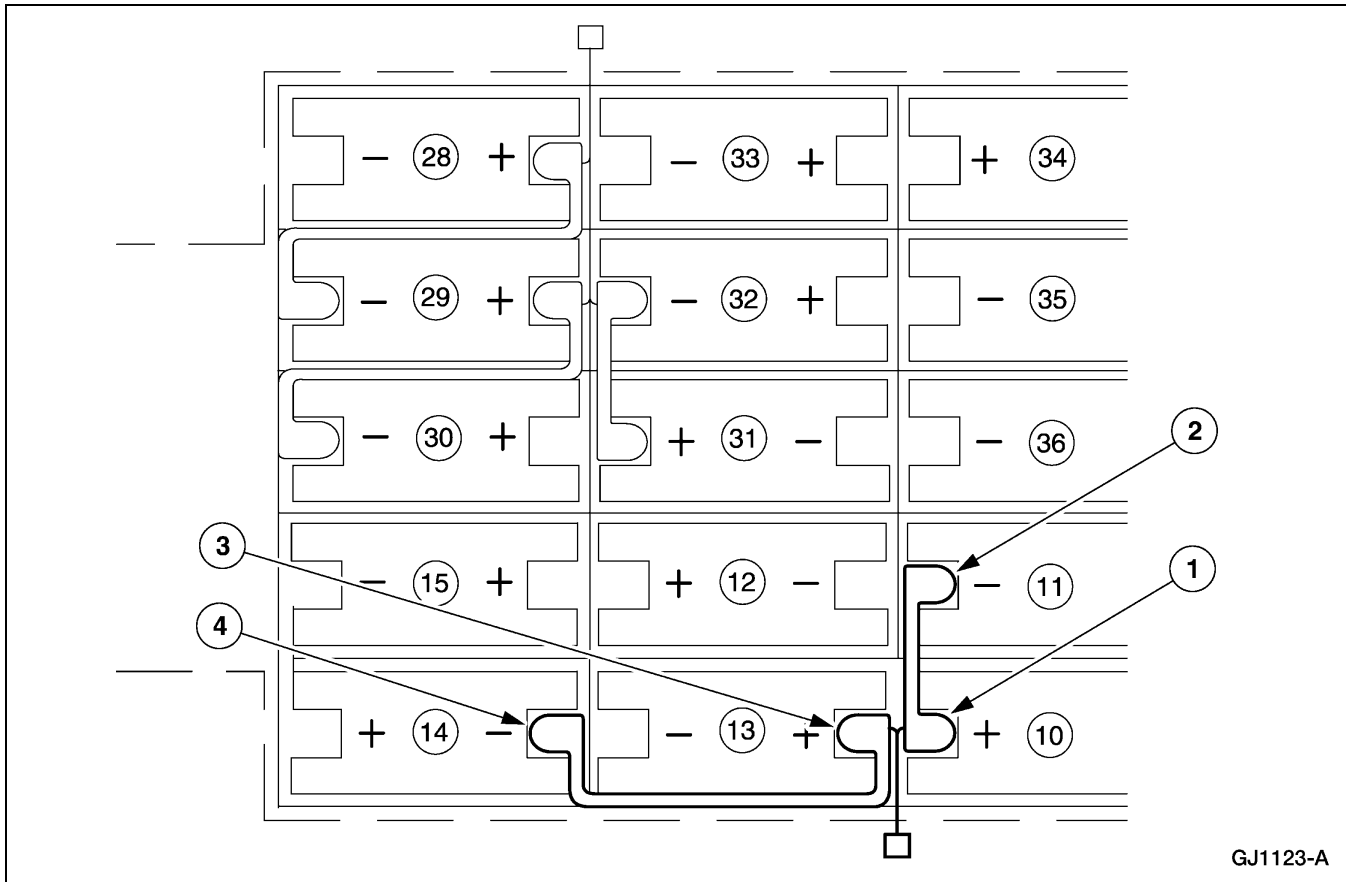

## 16. Install the R HVJ.

- 1 Install the 10+ nut.
- 2 Install the 11- nut.
- 3 Install the 13+ nut.
- 4 Install the 14- nut.

## DISASSEMBLY AND ASSEMBLY (Continued)

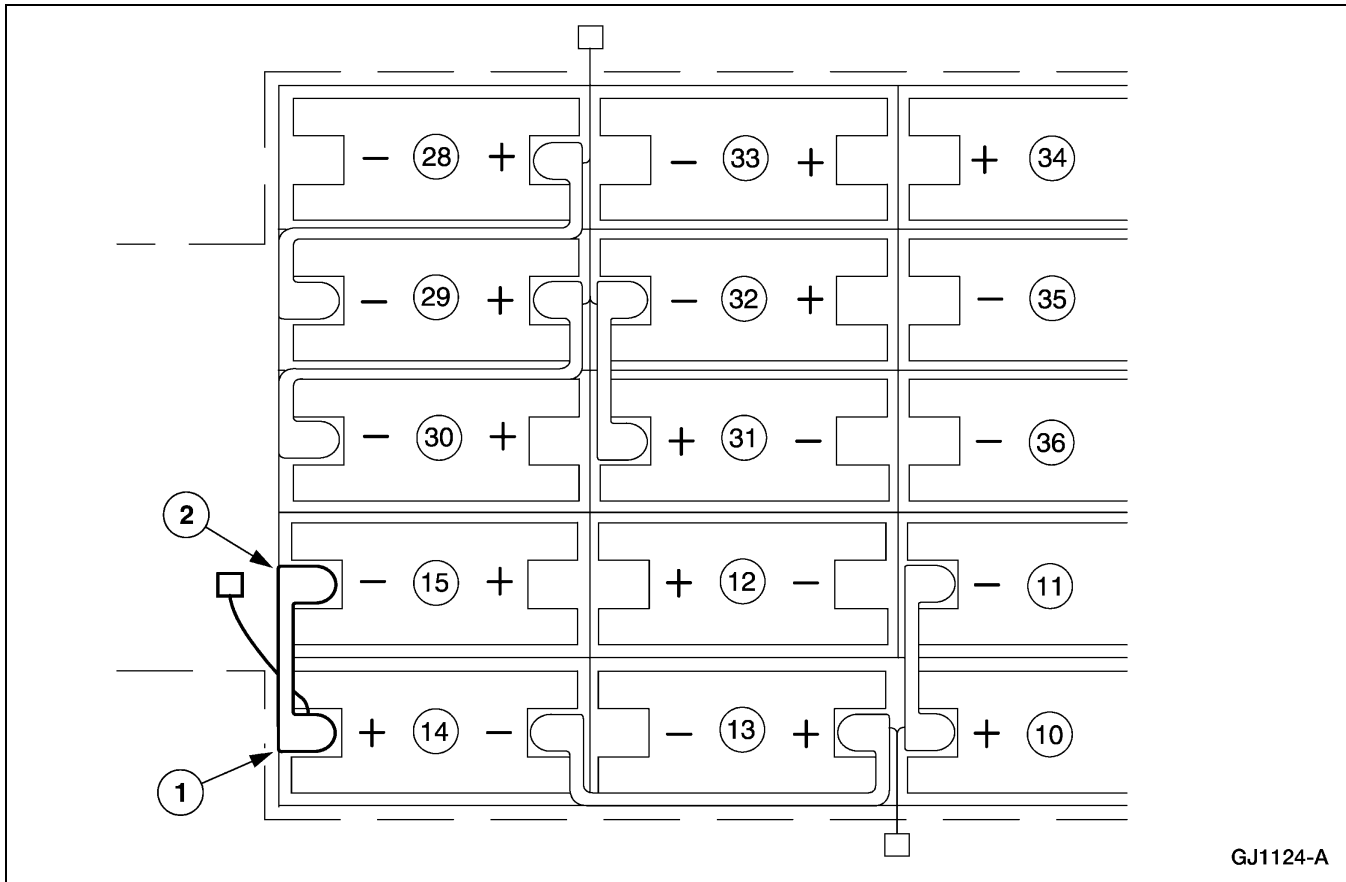

## 17. Install the K HVJ.

- 1 Install the 14+ nut.
- 2 Install the 15- nut.

## DISASSEMBLY AND ASSEMBLY (Continued)

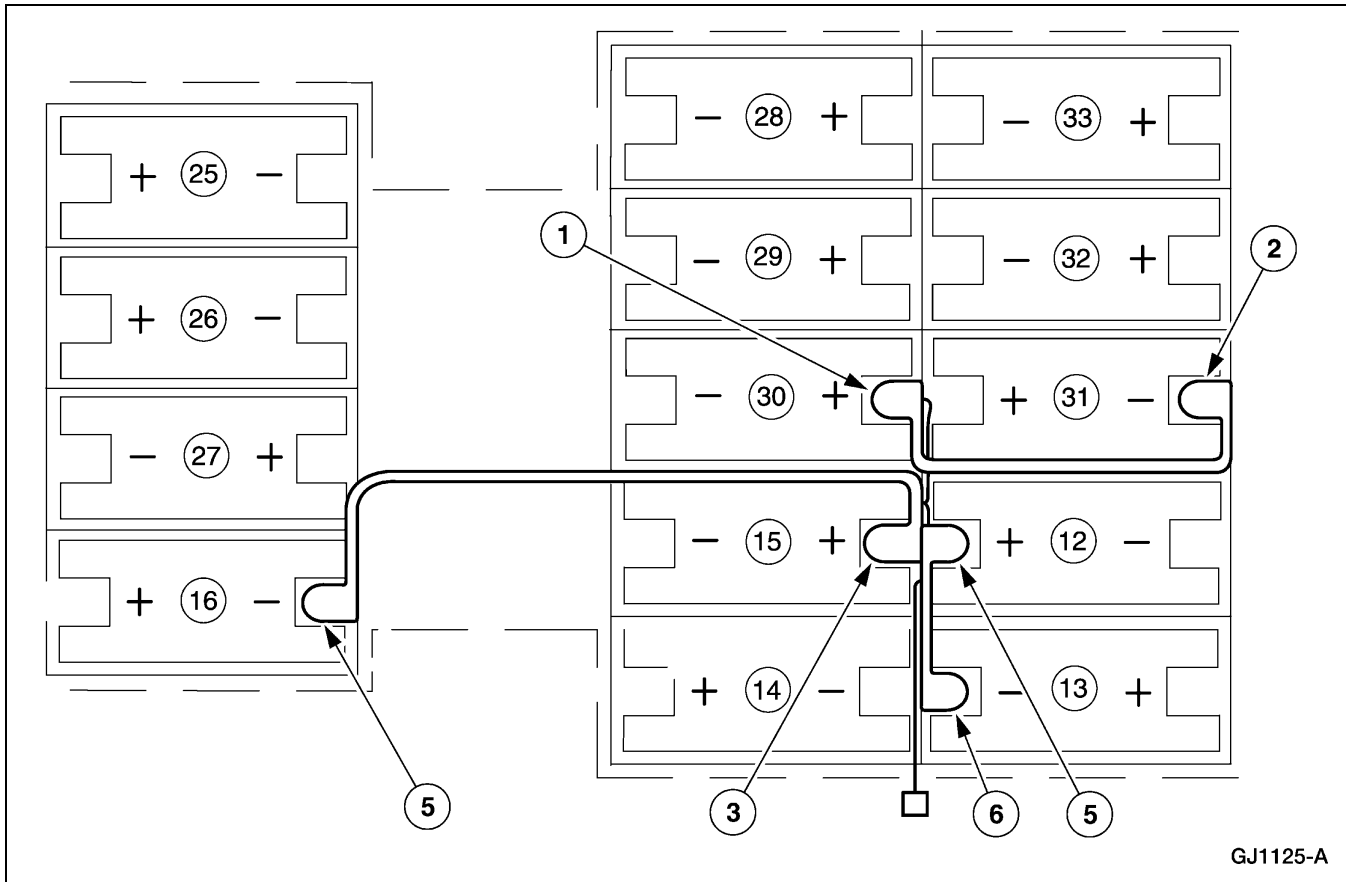

## 18. Install the J HVJ.

- 1 Install the 30+ nut.
- 2 Install the 31- nut.
- 3 Install the 15+ nut.
- 4 Install the 16- nut.
- 5 Install the 12+ nut.
- 6 Install the 13- nut.

## DISASSEMBLY AND ASSEMBLY (Continued)

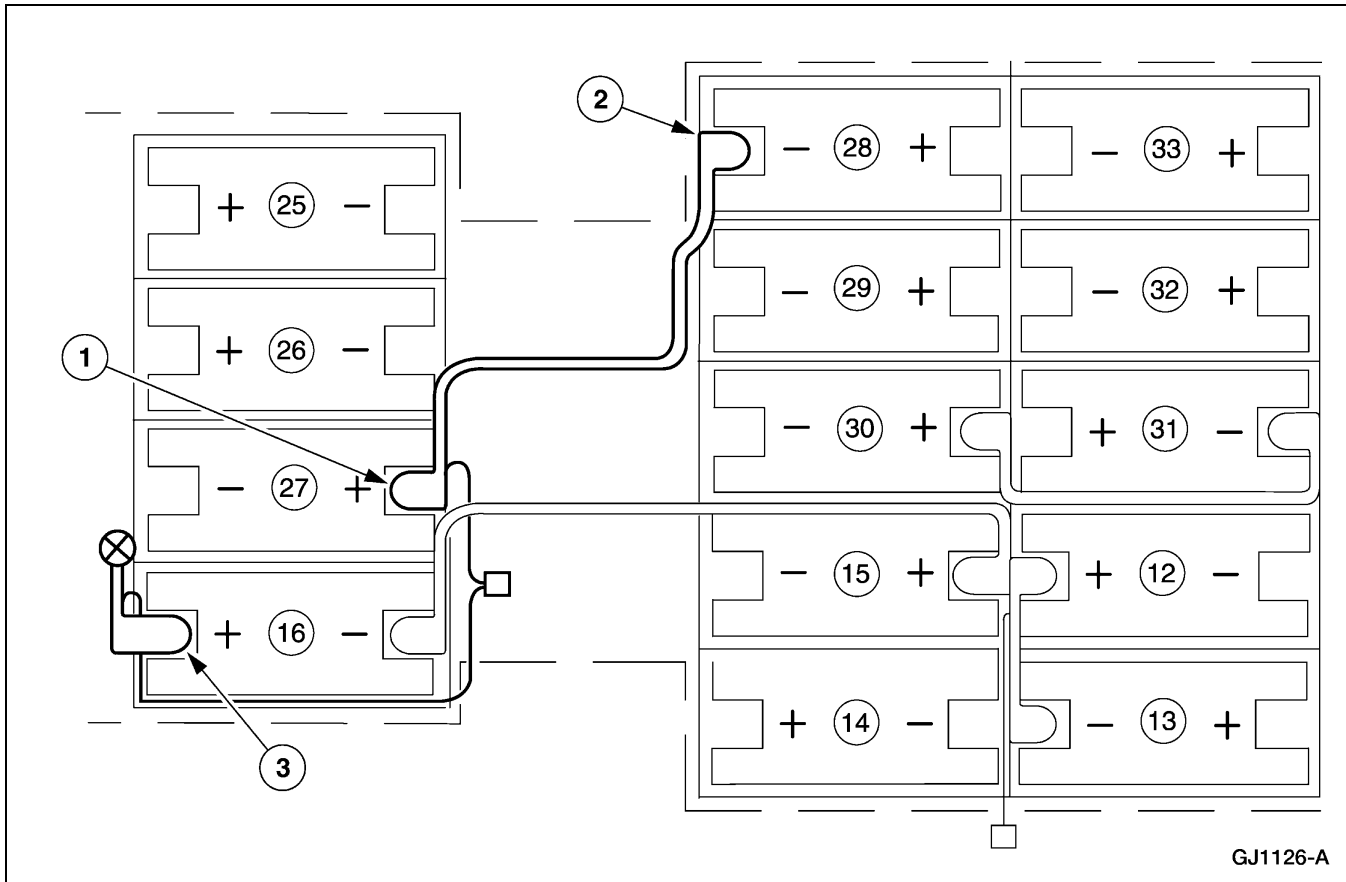

## 19. Install the L HVJ.

- 1 Install the 27+ nut.
  - 2 Install the 28- nut.
  - 3 Install the 16+ nut.
- The remaining end is not connected at this time. Close the cap.

## DISASSEMBLY AND ASSEMBLY (Continued)

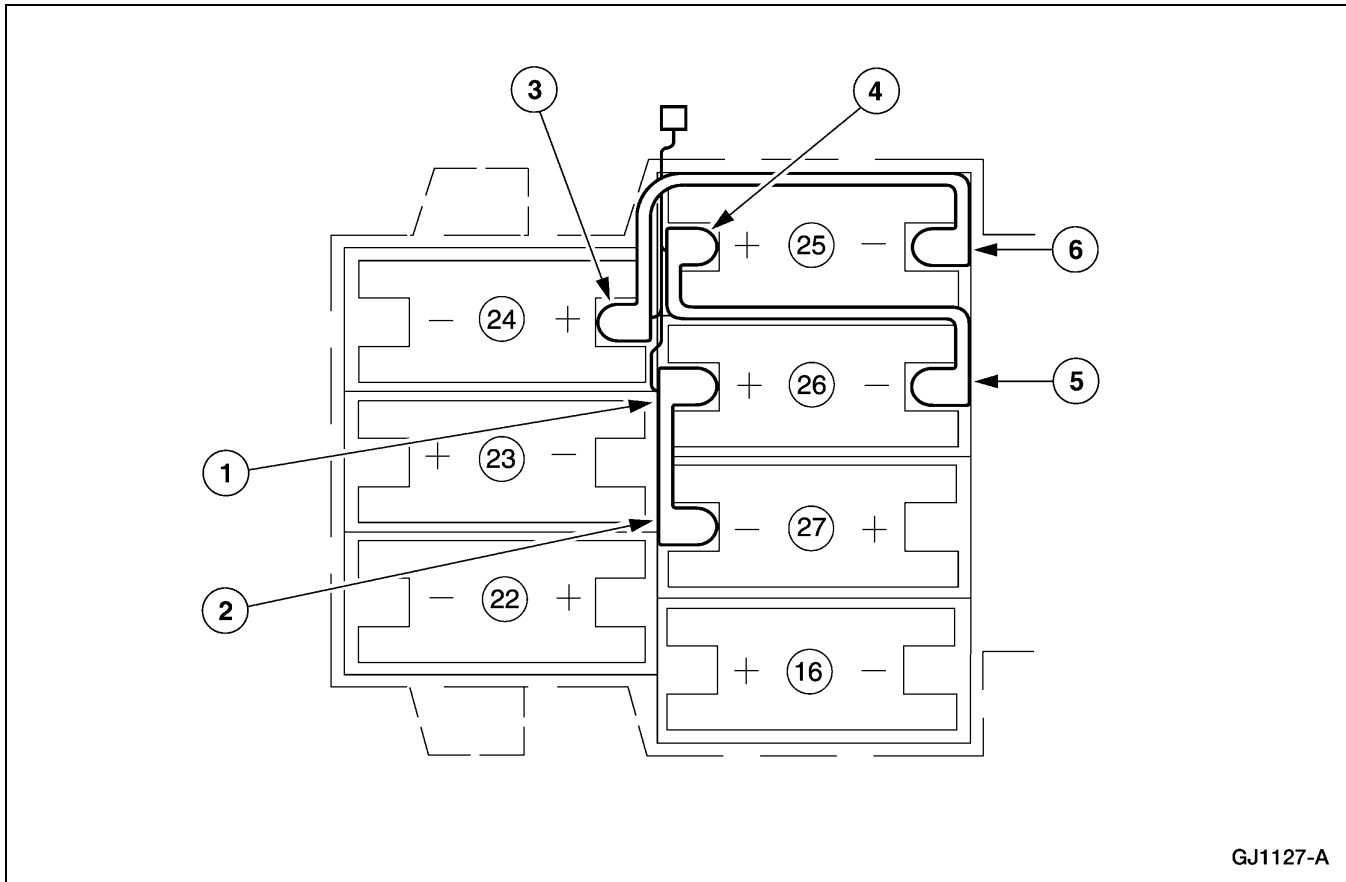

## 20. Install the N HVJ.

- 1 Install the 26+ nut.
- 2 Install the 27- nut.
- 3 Install the 24+ nut.
- 4 Install the 25+ nut.
- 5 Install the 26- nut.
- 6 Install the 25- nut.

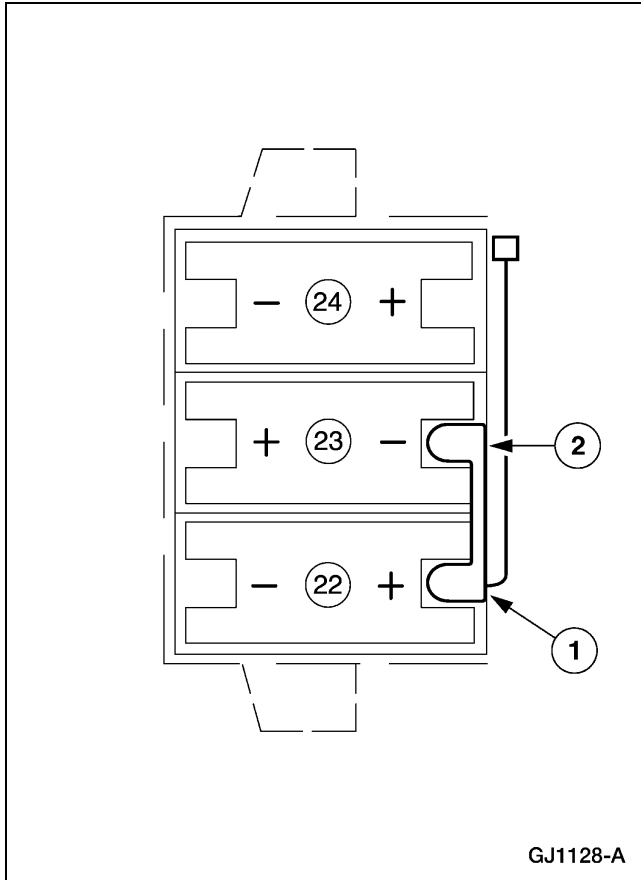
**DISASSEMBLY AND ASSEMBLY (Continued)**

21. Install the E HVJ.

- 1 Install the 22+ nut.
- 2 Install the 23- nut.

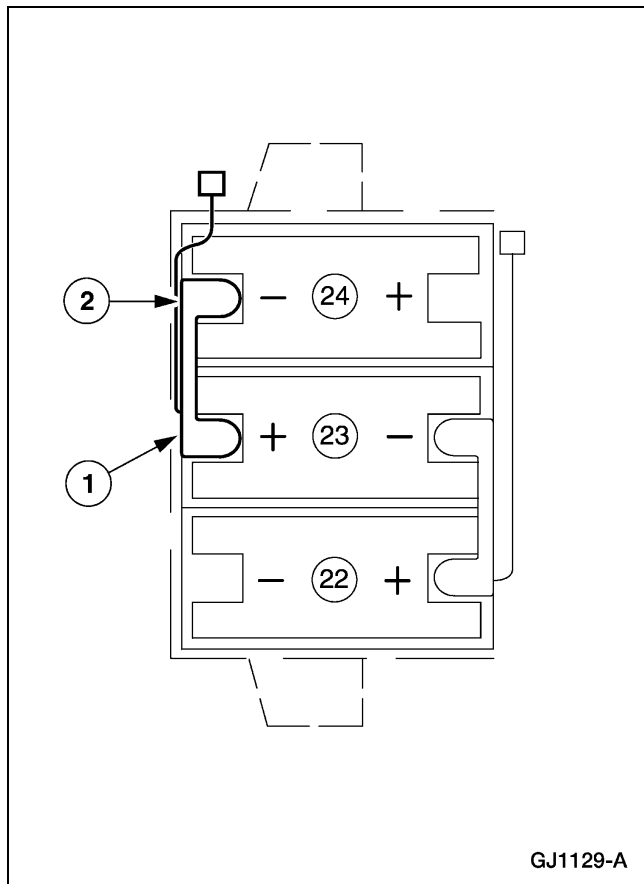
**DISASSEMBLY AND ASSEMBLY (Continued)**

22. Install the P HVJ.

- 1 Install the 23+ nut.
- 2 Install the 24- nut.



**DISASSEMBLY AND ASSEMBLY (Continued)**

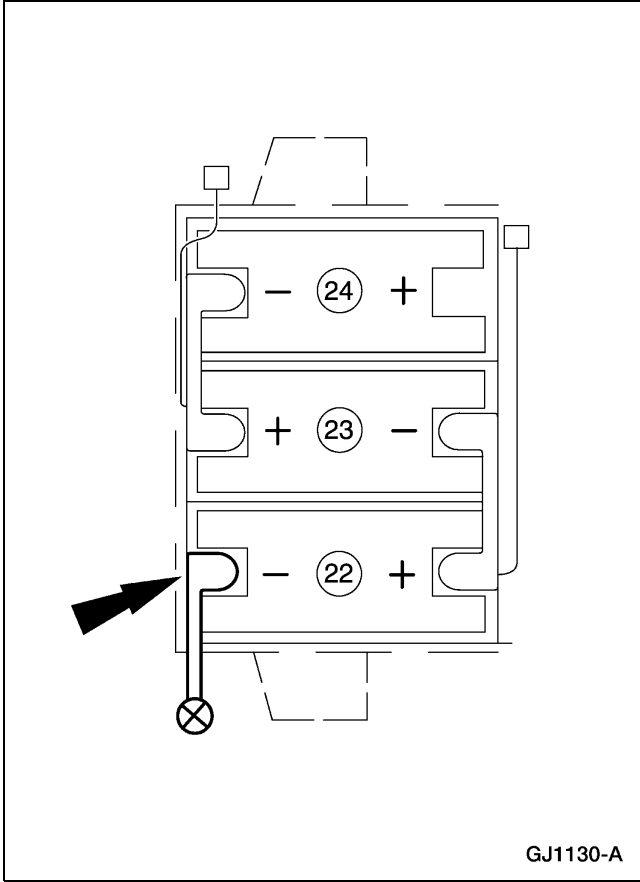

23. Install the M HVJ.

- Install the 22- nut.
- The remaining end is not connected at this time. Close the cap.

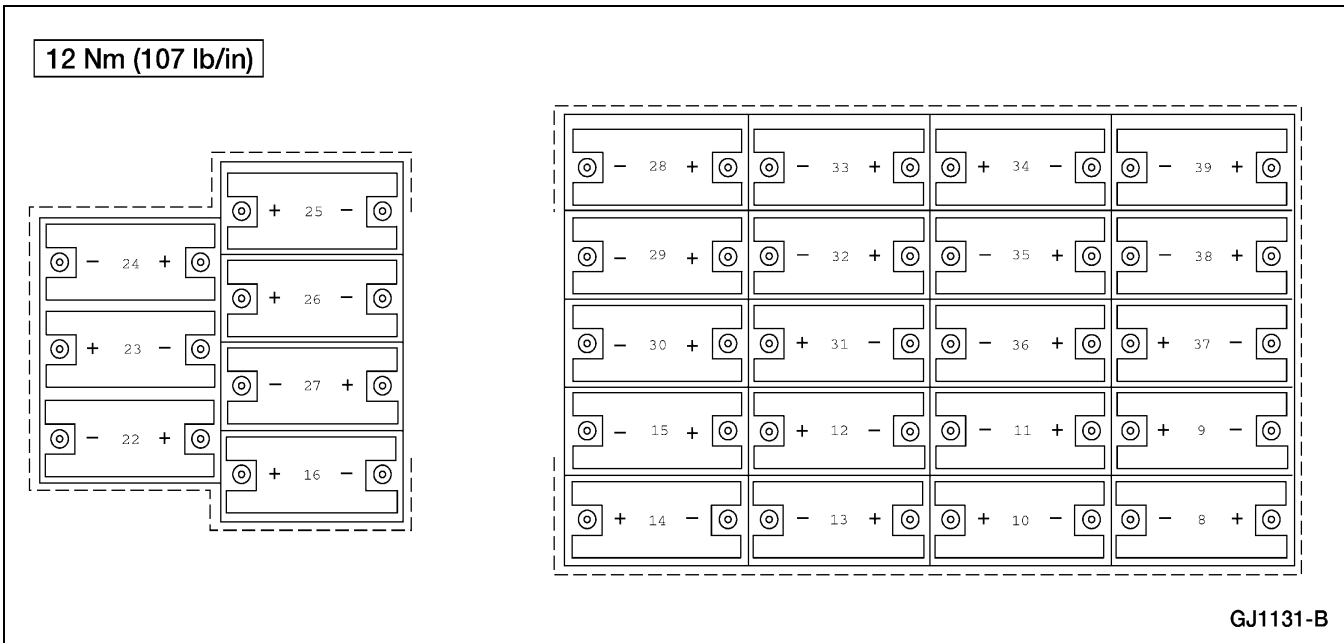

24. Using the Battery Post Torque Wrench, tighten the HVJ to battery module nuts.

## DISASSEMBLY AND ASSEMBLY (Continued)

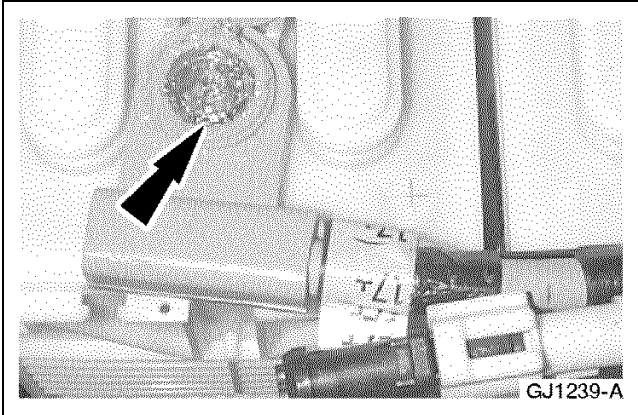

25. Fill the area around the high-voltage jumper nuts with Nyogel and snap the caps closed.

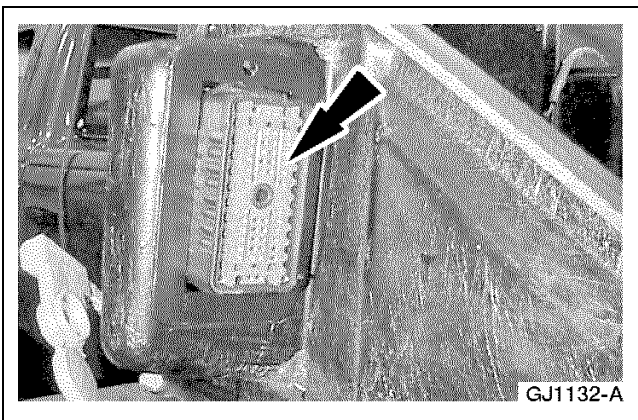

26. **NOTE:** The 76-pin connector is part of the low-voltage wiring harness and is installed from the inside of the battery tray.

Install the 76-pin connector.

- Clip the bottom of the connector into the tray first, then the top.

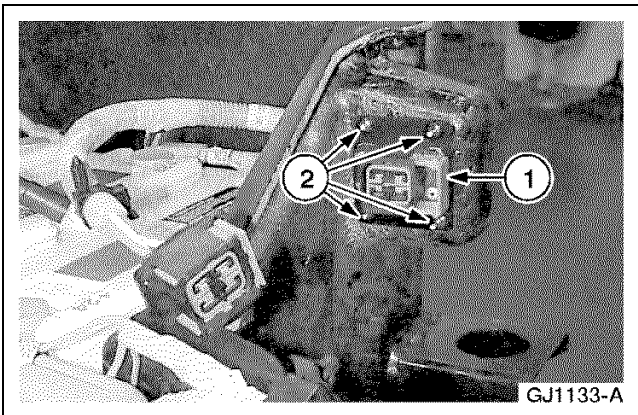

27. **NOTE:** This step only applies to initial traction battery build-up. These components were not separated during the disassembly procedure.

**NOTE:** Install the jumper with the red connector lock facing away from the battery tray.

Install the four pin contactor box jumper.

- 1 Install the jumper.
- 2 Install rivets to secure the jumper.

## DISASSEMBLY AND ASSEMBLY (Continued)

**NOTE:** The temperature sensor harness feeds up through the space between the separators.

**NOTE:** The HVJ wiring that runs between the battery modules must fit into the separators.

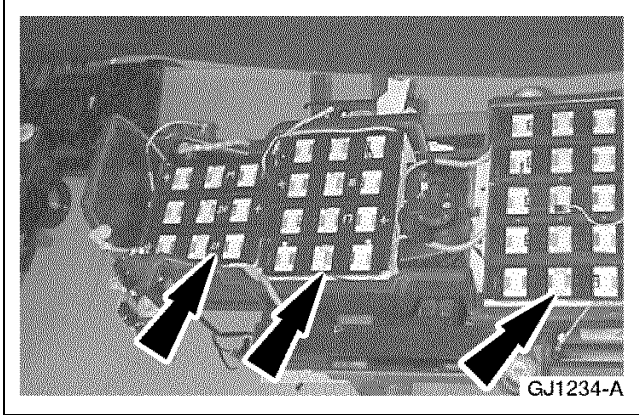

28. Install the front separator plates.

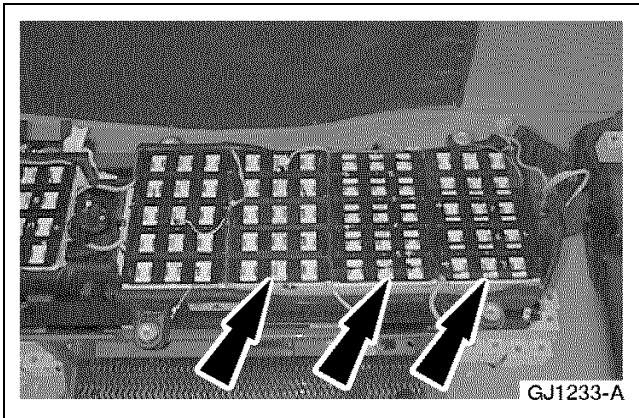

29. **NOTE:** The rear separator can be identified by the velcro strips on the right-hand side. These strips are for holding the contactor box in position.

Install the rear separator plates.

30. Use a heat gun to warm the temperature sensor prior to installation.

31. Apply a thin coat of thermal grease to the back of the thermistor.

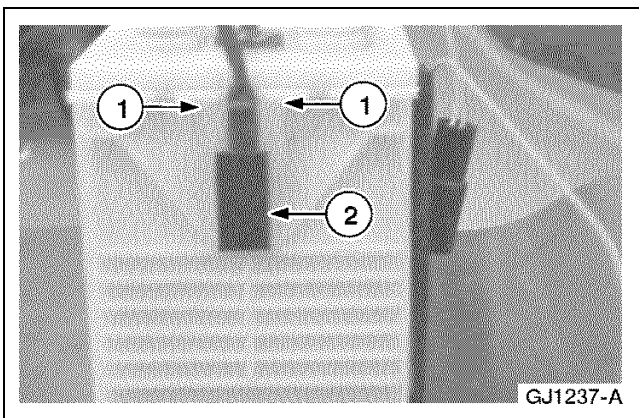

32. **⚠ CAUTION: Do not use excessive force to install the temperature sensor, or damage to the module may occur.**

Install a temperature sensor on the - (negative) terminal side of battery modules 16 and 17.

- 1 Position the temperature sensor prongs into the holes in the battery module.
- 2 Clip the temperature sensor into the pin on the battery module.

## DISASSEMBLY AND ASSEMBLY (Continued)

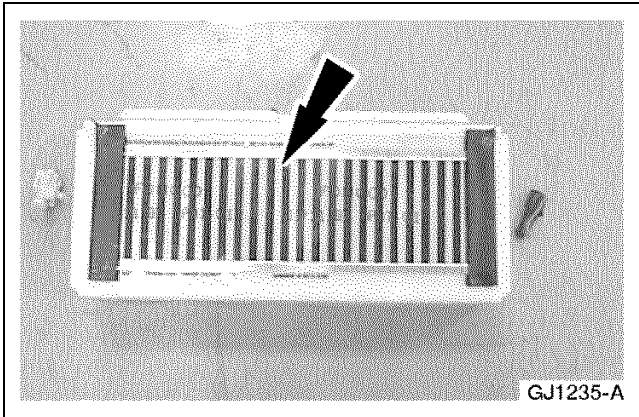

33. The upper battery module heating elements are adhesive backed and are positioned on the battery modules as illustrated in the following steps.

**NOTE:** The battery modules must be installed with the terminals oriented correctly. Verify correct installation.

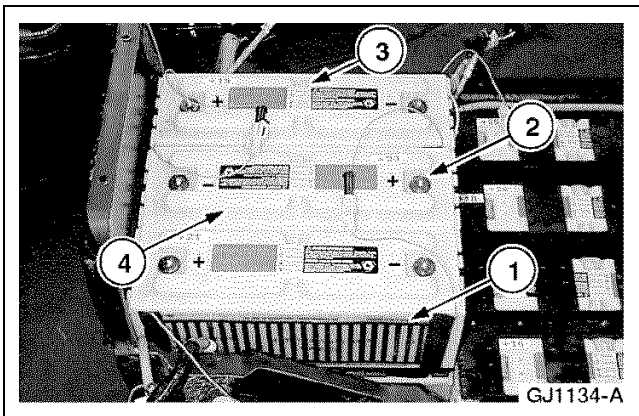

34. Install the upper front battery modules.
- 1 Apply the heating element to battery module 21 on the side facing out, and install the battery module.
  - 2 Apply the heating element to battery module 20 on the side facing battery module 21, and install the battery module.
  - 3 Apply the heating element to battery module 19 on the side facing out, and install the battery module.
  - 4 Connect the heating element electrical connectors.
    - Connect the battery module 19 male connector to the battery module 20 female connector.
    - Connect the battery module 20 male connector to the battery module 21 female connector.

## DISASSEMBLY AND ASSEMBLY (Continued)

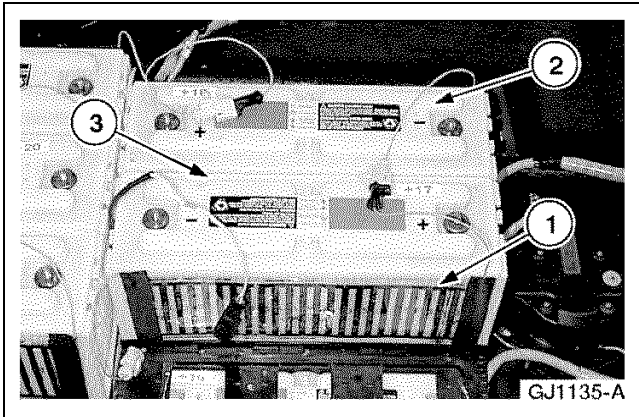

## 35. Install the upper front battery modules.

- 1 Apply the heating element to battery module 17 on the side facing out, and install the battery module.
- 2 Apply the heating element to battery module 18 on the side facing out, and install the battery module.
- 3 Connect the heating element electrical connectors.
  - Connect the battery module 19 female connector to the battery module 18 male connector.
  - Connect the battery module 18 female connector to the battery module 17 male connector.

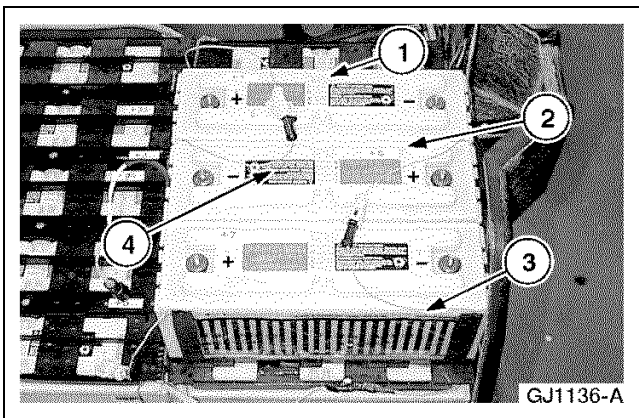

## 36. Install the upper rear battery modules.

- 1 Apply the heating element to battery module 1 on the side facing out, and install the battery module.
- 2 Apply the heating element to battery module 6 on the side facing battery module 1, and install the battery module.
- 3 Apply the heating element to battery module 7 on the side facing out, and install the battery module.
- 4 Connect the heating element electrical connectors.
  - Connect the battery module 1 female connector to the battery module 6 male connector.
  - Connect the battery module 6 female connector to the battery module 7 male connector.

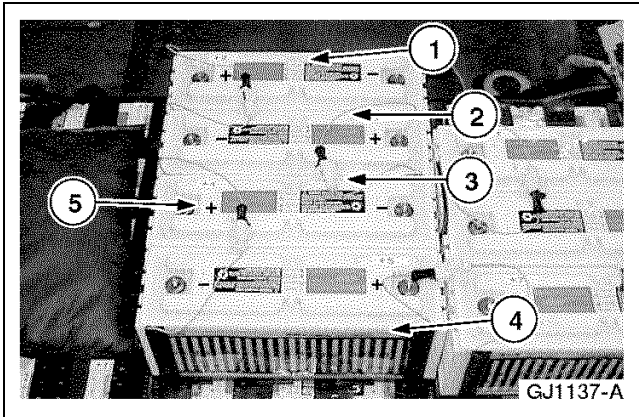
**DISASSEMBLY AND ASSEMBLY (Continued)**

37. Install the remaining upper rear battery modules.
  - 1 Apply the heating element to battery module 2 on the side facing out, and install the battery module.
  - 2 Apply the heating element to battery module 3 on the side facing battery module 2, and install the battery module.
  - 3 Apply the heating element to battery module 4 on the side facing battery module 3, and install the battery module.
  - 4 Apply the heating element to battery module 5 on the side facing out, and install the battery module.
  - 5 Connect the heating element electrical connectors.
    - Connect the battery module 2 male connector to the battery module 3 female connector.
    - Connect the battery module 3 male connector to the battery module 4 female connector.
    - Connect the battery module 4 male connector to the battery module 5 female connector.

**DISASSEMBLY AND ASSEMBLY (Continued)**

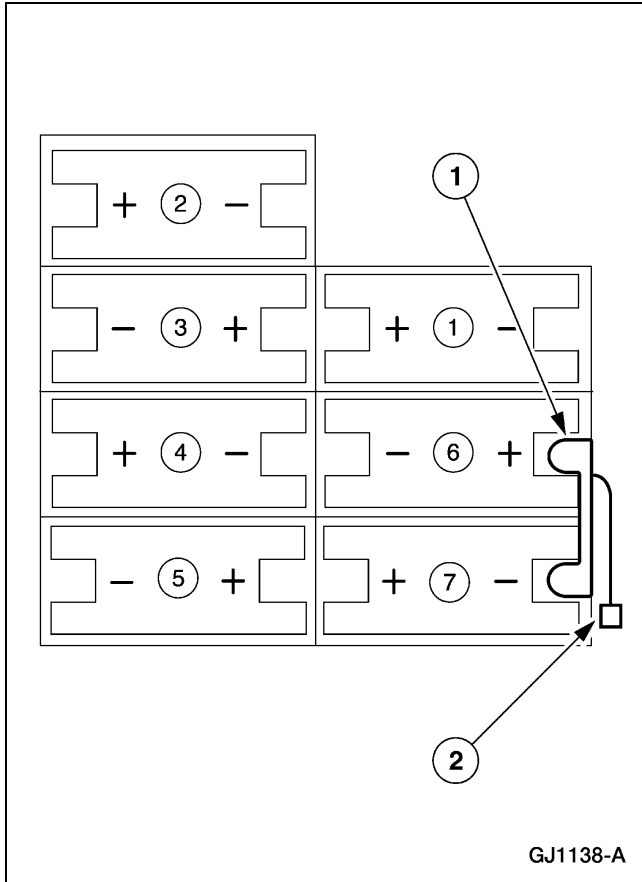

38. Install the D HVJ.

- 1 Install the 6+ nut.
- 2 Install the 7- nut.

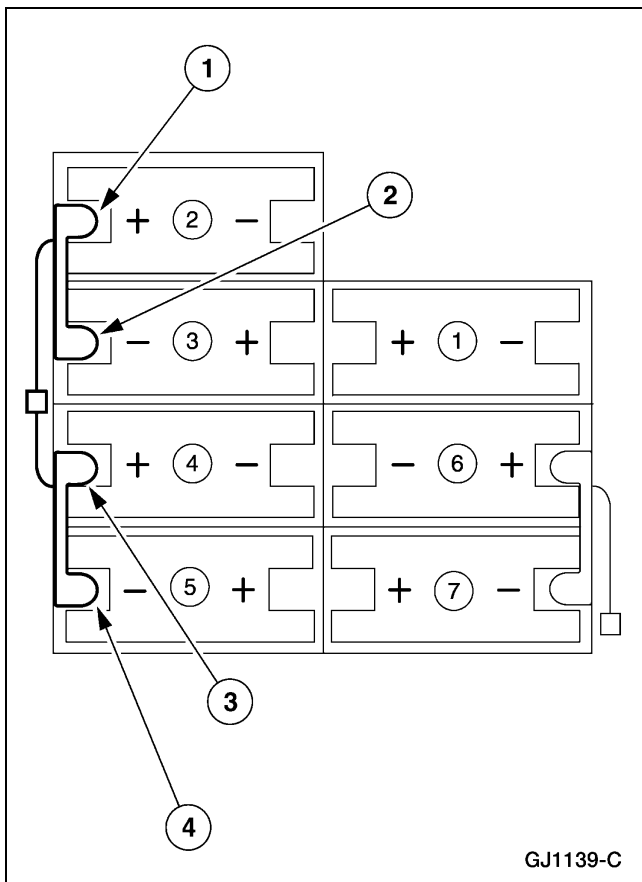

39. Install the B HVJ.

- 1 Install the 2+ nut.
- 2 Install the 3- nut.
- 3 Install the 4+ nut.
- 4 Install the 5- nut.

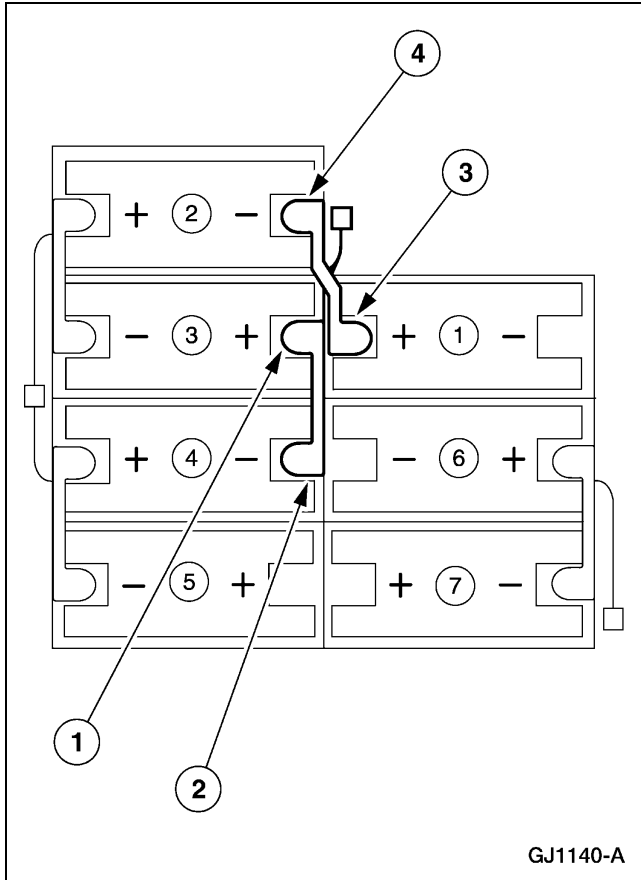
**DISASSEMBLY AND ASSEMBLY (Continued)**

## 40. Install the A HVJ.

- 1 Install the 3+ nut.
- 2 Install the 4- nut.
- 3 Install the 1+ nut.
- 4 Install the 2- nut.

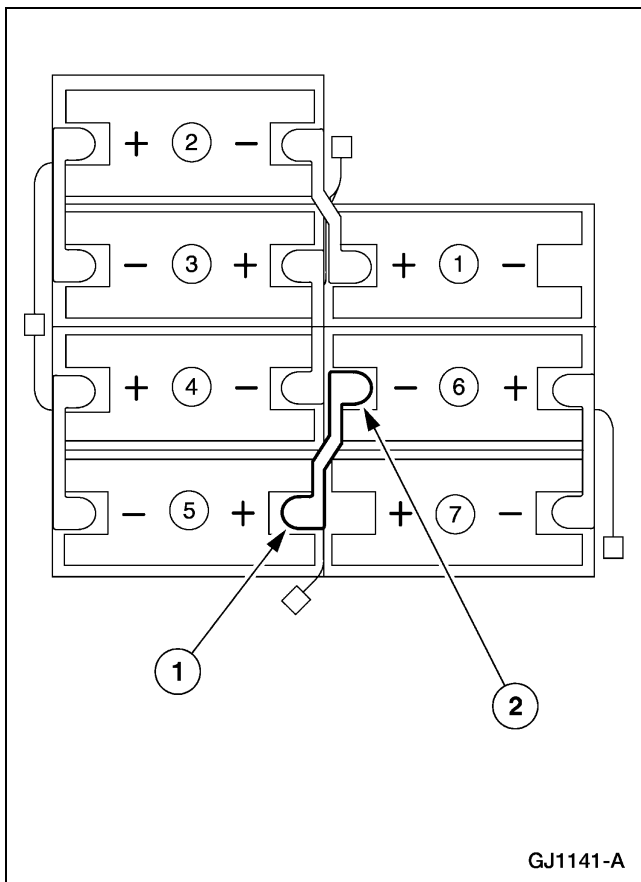

## 41. Install the L HVJ.

- 1 Install the 5+ nut.
- 2 Install the 6- nut.



## DISASSEMBLY AND ASSEMBLY (Continued)

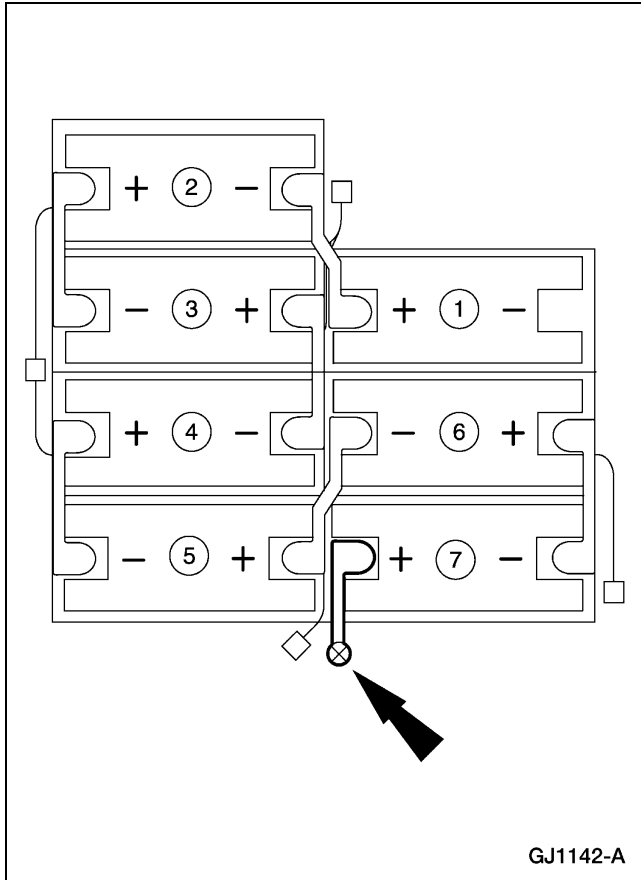

42. Connect the remaining G HVJ end from the lower level battery module to the 7+ battery module terminal.

- Install the nut.

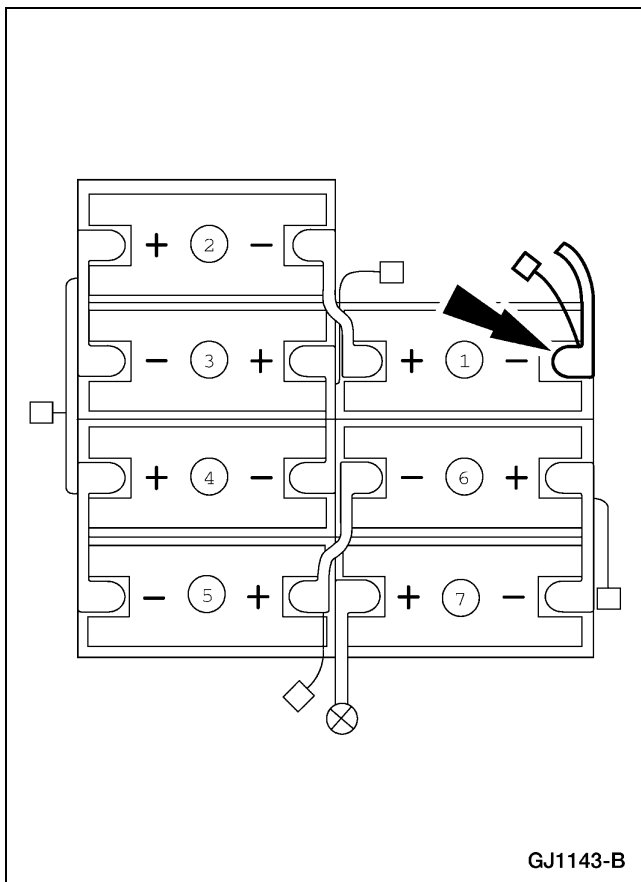

43. **NOTE:** The remaining end of the H HVJ is not connected at this time.

Connect the H HVJ to the 1- battery module terminal.

- Install the nut.

## DISASSEMBLY AND ASSEMBLY (Continued)

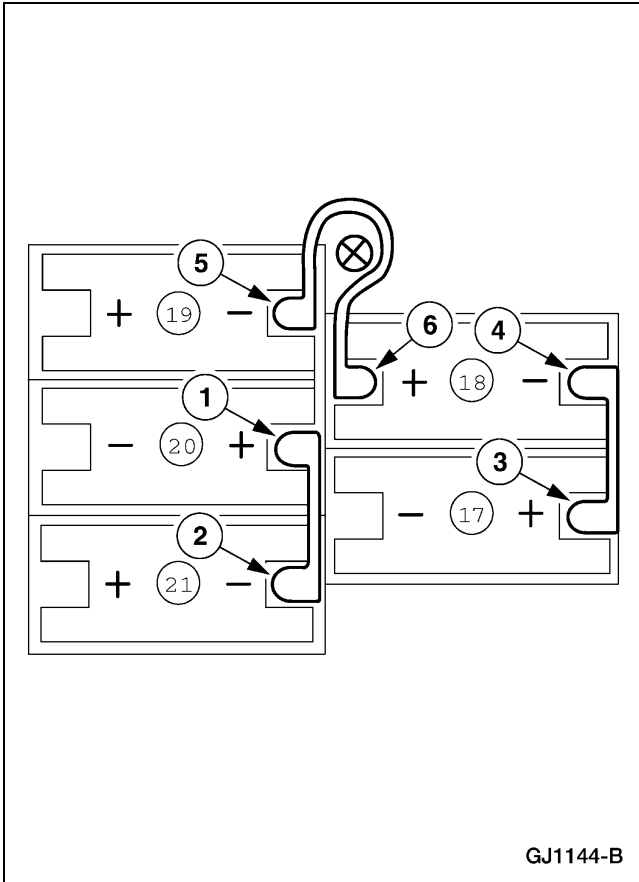

44. **NOTE:** The F HVJ contains a large fuse that is routed around the rear of the battery modules.

Install the F HVJ.

- 1 Install the 20+ nut.
- 2 Install the 21- nut.
- 3 Install the 17+ nut.
- 4 Install the 18- nut.
- 5 Install the 19- nut.
- 6 Install the 18+ nut.

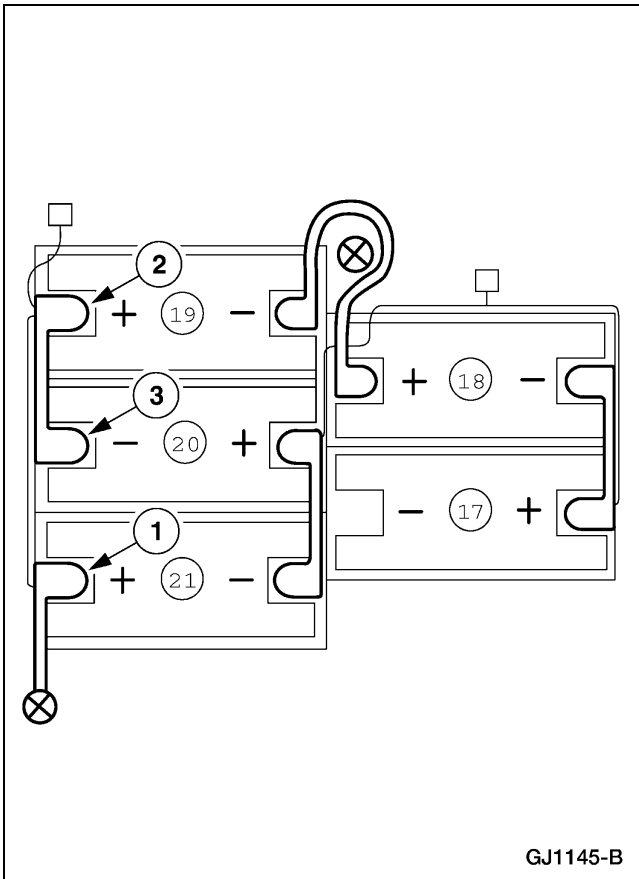

45. Connect the remaining M HVJ ends from the lower-level battery module.

- 1 Install the 21+ nut.
- 2 Install the 20- nut.
- 3 Install the 19+ nut.

**DISASSEMBLY AND ASSEMBLY (Continued)**

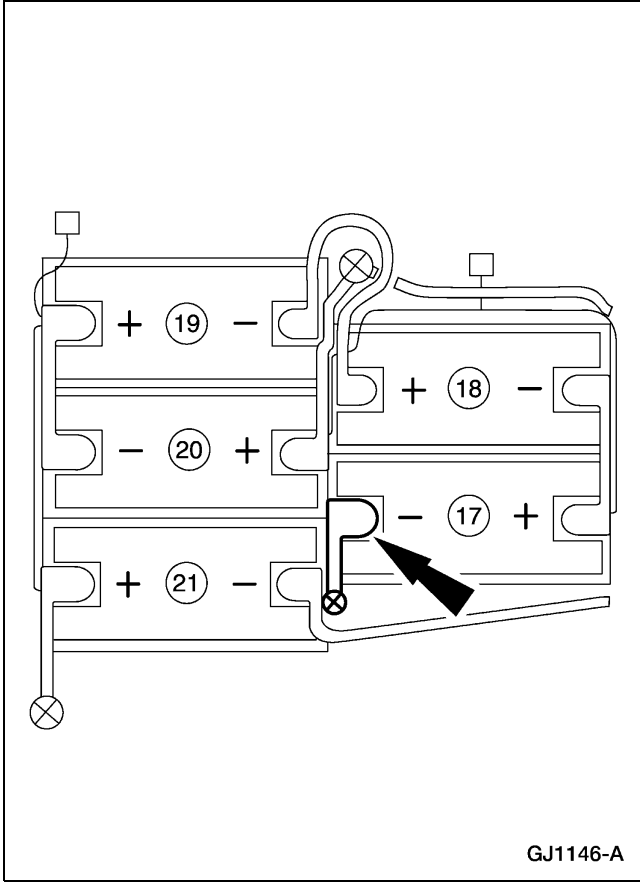

46. **⚠ WARNING: This step will energize the traction battery. Do not touch the contactor box HVJs or allow them to touch each other.**

Connect the remaining L HVJ end from the lower level battery module.

- Install the nut.

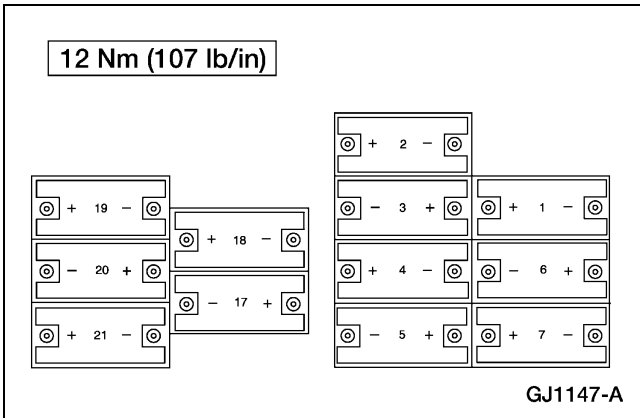

47. Using the Battery Post Torque Wrench, tighten the HVJ to battery module nuts.

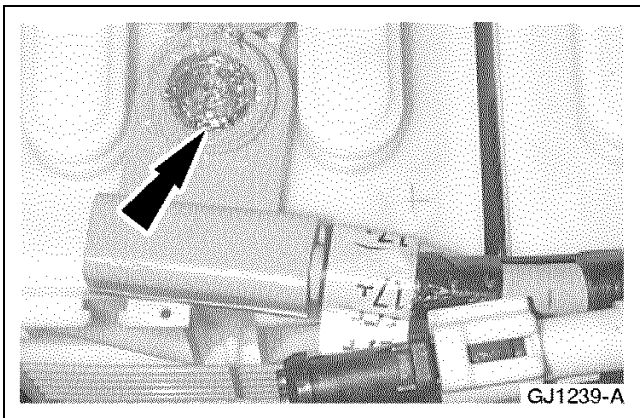

48. Fill the area around the HVJ nuts with Nyogel and snap the caps closed.

## DISASSEMBLY AND ASSEMBLY (Continued)

49. Probe the contactor box HVJs to verify correct traction battery voltage. The voltage should be approximately 323 volts DC.
50. Wrap the contactor box HVJs with orange electrical tape to prevent contact or shorting.
51. **NOTE:** The HVJ wiring that runs between the battery modules must fit into the separators. Install the front battery module separator plates.

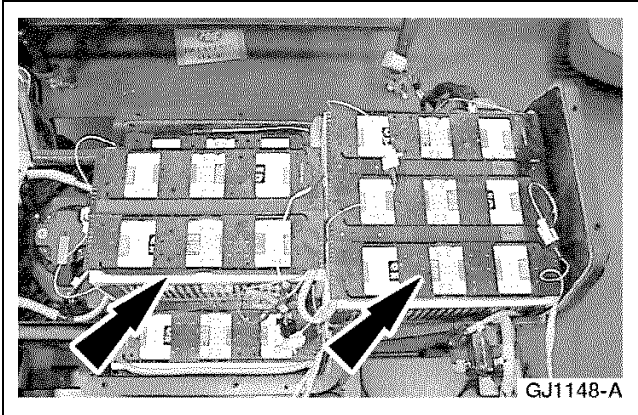

52. Install the rear battery module separator plates.

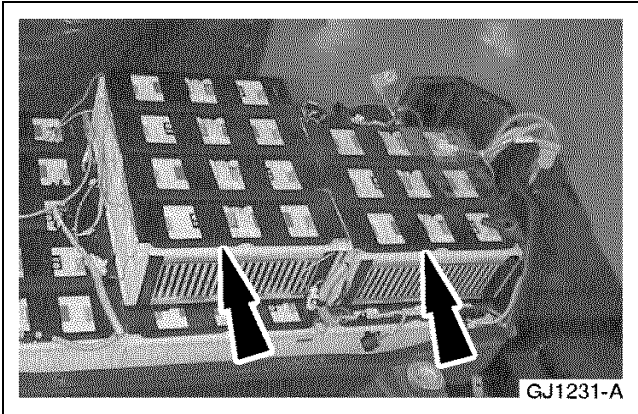

53. **NOTE:** The contactor box is held in position with strips of Velcro™. Install the contactor box in the rear RH side of the traction battery.

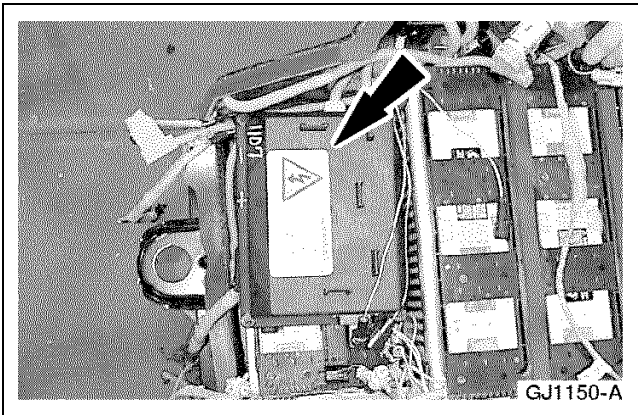

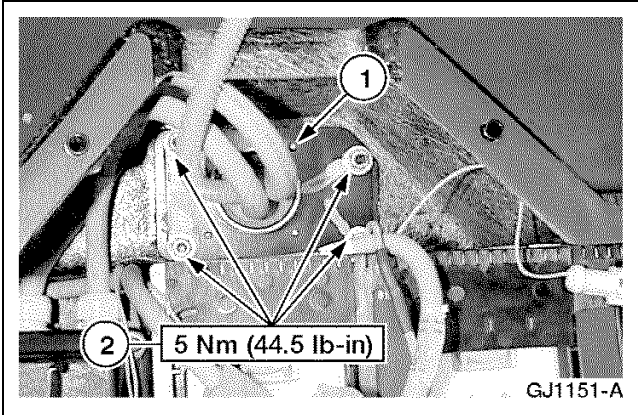
**DISASSEMBLY AND ASSEMBLY (Continued)**

54. Install the two-pin connector in the tray.

- 1 Position the connector.
- 2 Install the four nuts.

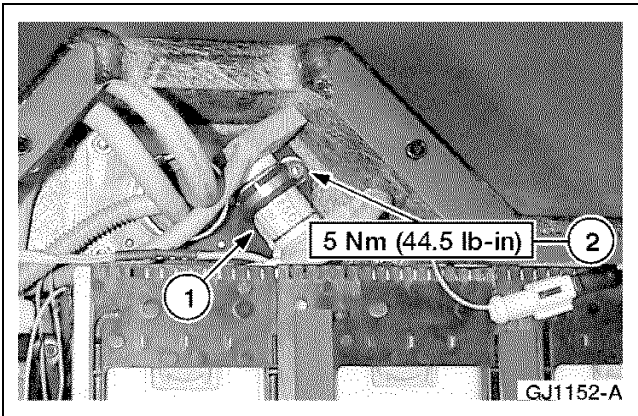

55. Mount the fuse.

- 1 Position the fuse bracket on the left rear stud.
- 2 Install the nut.

## DISASSEMBLY AND ASSEMBLY (Continued)

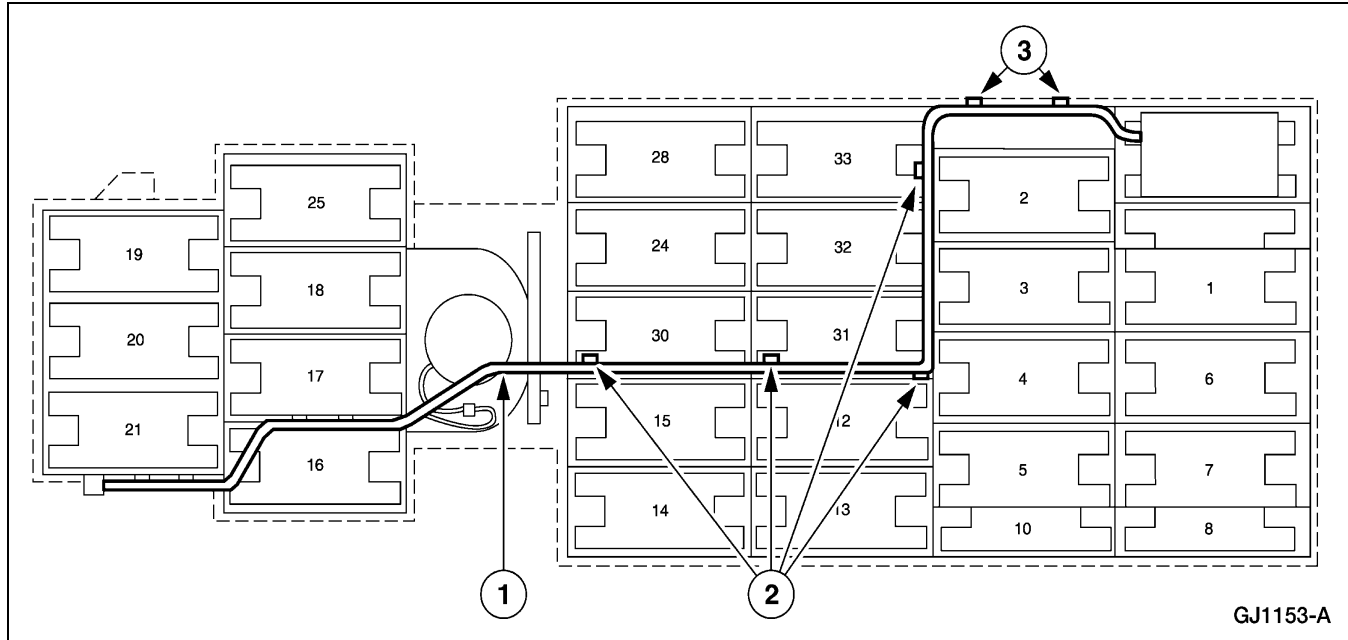

56. Install the black low-voltage harness (part of the 76-pin harness).

- 1 Position the harness with the two BCM connectors at the front of the pack.
- 2 Push the four harness clips into the separator plate.
- 3 Clip the two harness side clips onto the separator plate.

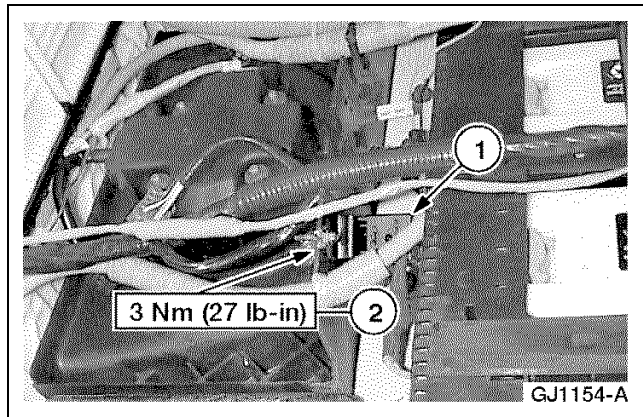

57. Install the cooling fan relay.

- 1 Position the cooling fan relay.
- 2 Install the screw.

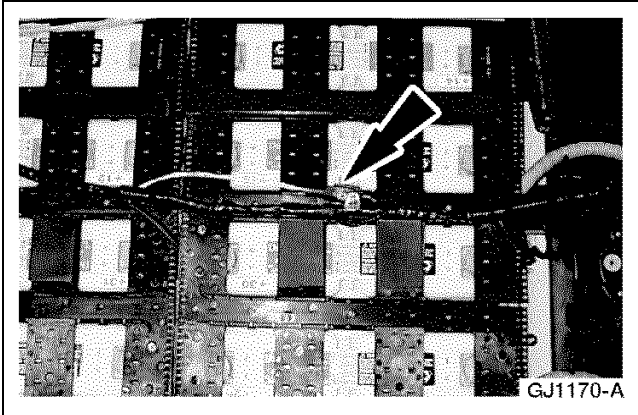
**DISASSEMBLY AND ASSEMBLY (Continued)**

58. Connect the temperature sensor electrical connector to the low-voltage harness.

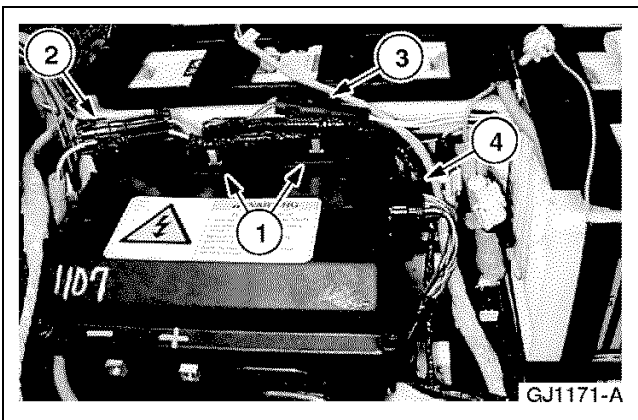

59. Connect the low-voltage harness to the contactor box.
- 1 Clip the two harness clips to the contactor box.
  - 2 Connect the two-pin auxiliary connector.
  - 3 Connect the temperature sensor connector.
  - 4 Connect the harness connector to the contactor box.

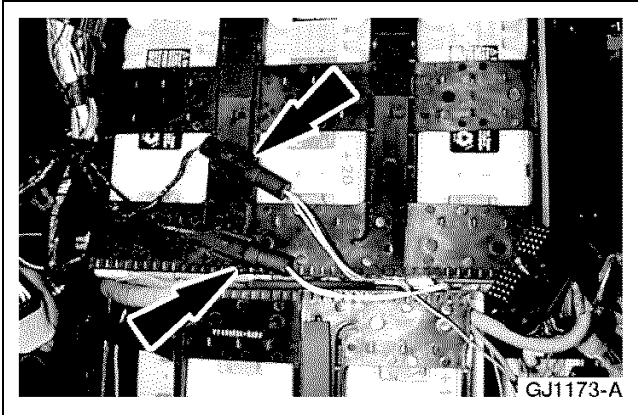

60. Connect and clip the sense lead wiring to the separator plate.

**DISASSEMBLY AND ASSEMBLY (Continued)**

61. Connect the two temperature sensor electrical connectors.
  - Connect the 17- to the brown / brown and white connector.
  - Connect the 26+ lead to the green / red connector.

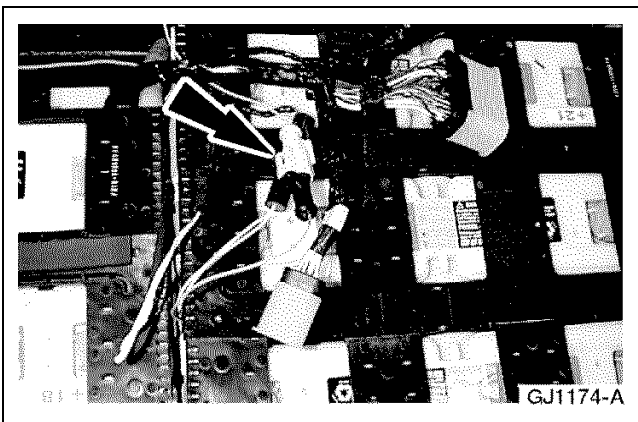

62. Connect the heating element connector.
  - Clip the connector on the low-voltage harness connector.

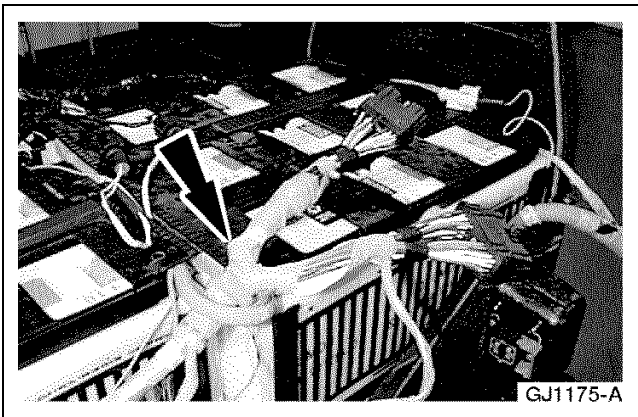

63. Position the orange high-voltage harness.
  - The high-voltage harness passes through the HVJ as illustrated.

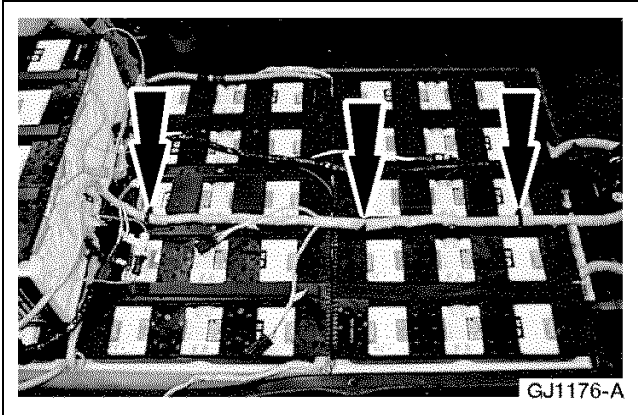

**DISASSEMBLY AND ASSEMBLY (Continued)**

64. Clip the three high-voltage harness clips onto the separator plate.

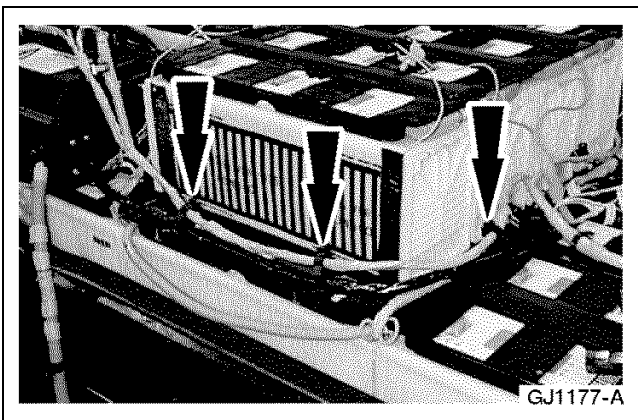

65. Clip the three high-voltage harness clips onto the separator plate.

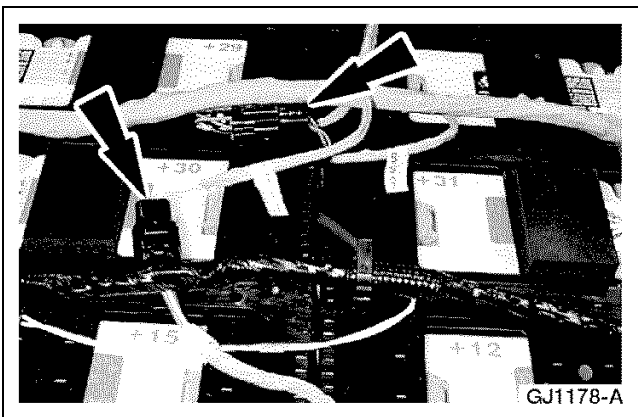

66. Connect the J and S high-voltage connectors and clip them onto the separator plate.

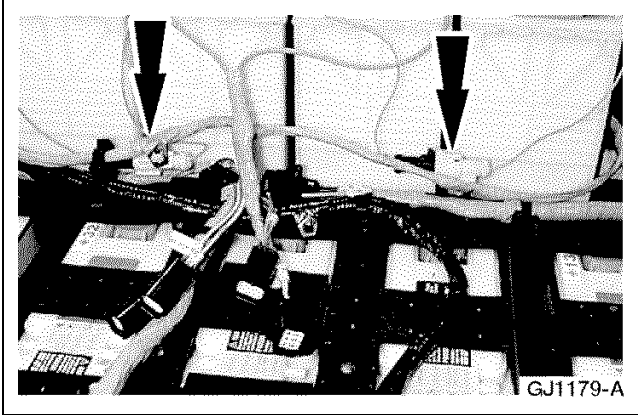
**DISASSEMBLY AND ASSEMBLY (Continued)**

67. Clip the heater harness connectors onto the high-voltage harness.

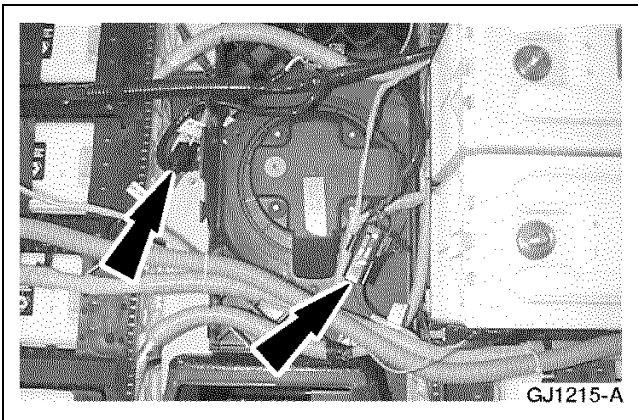

68. Connect the K and L sense lead connectors.

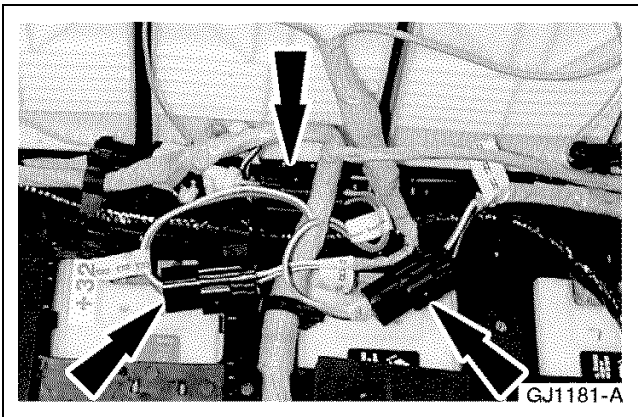

69. Connect the T, B, and H sense lead connectors.
- 1 Connect the T, B, and H connectors.
  - 2 Clip the H connector into the separator plate.
  - 3 Clip the T and B connectors into the wiring harness.

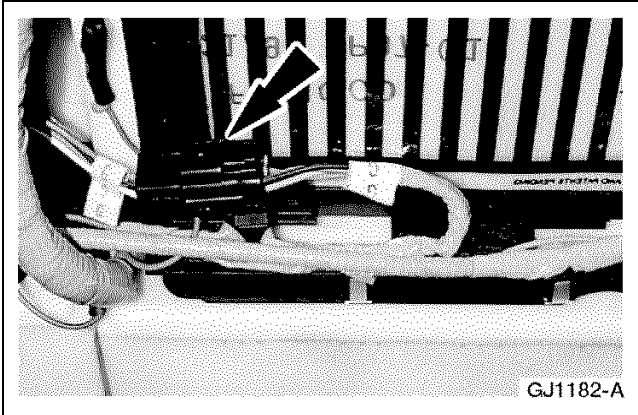
**DISASSEMBLY AND ASSEMBLY (Continued)**

70. Connect the G sense lead connector.

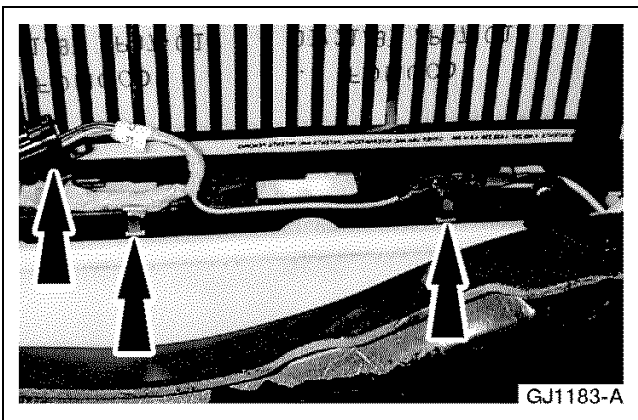

71. Clip the G sense lead harness into the separator plate.

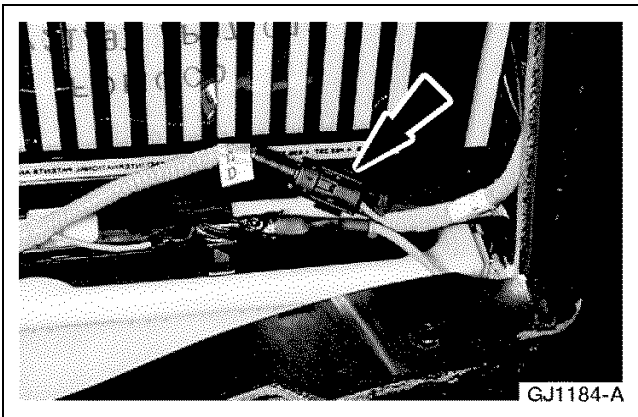

72. Connect the D sense lead connector.

**DISASSEMBLY AND ASSEMBLY (Continued)**

73. Connect the C sense lead connector.

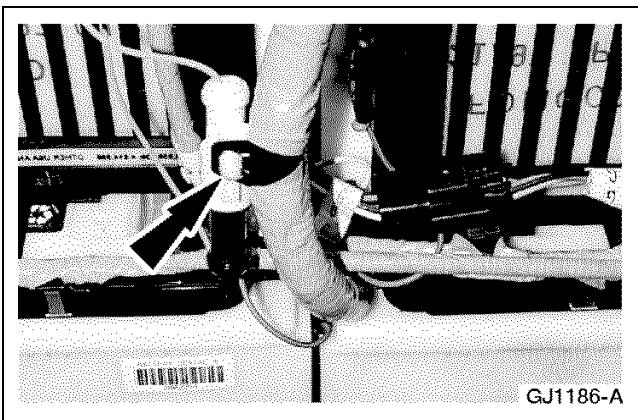

74. Clip the heater connector into the high-voltage harness.

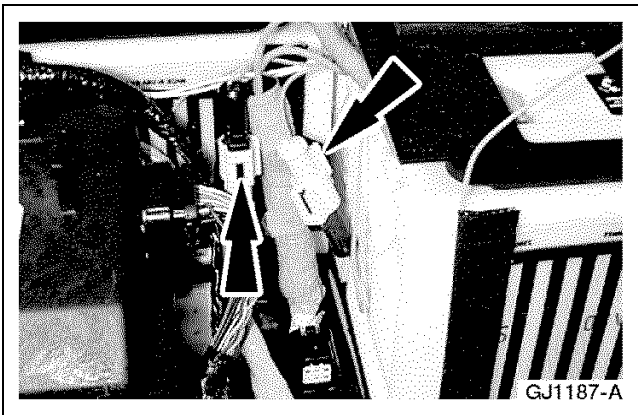

75. Clip the two heating element connectors into the high-voltage harness, located behind the contactor box.

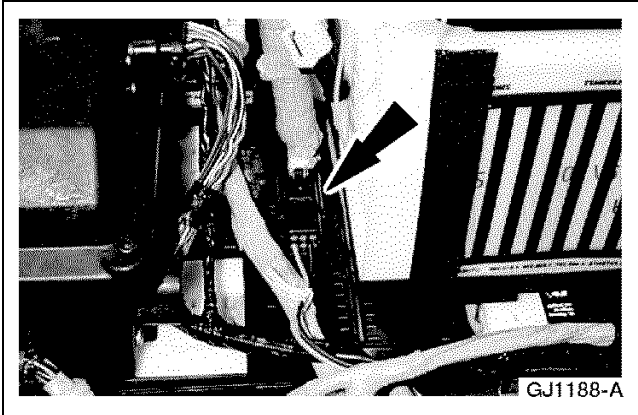
**DISASSEMBLY AND ASSEMBLY (Continued)**

76. Connect the A sense lead and clip it into the separator plate.

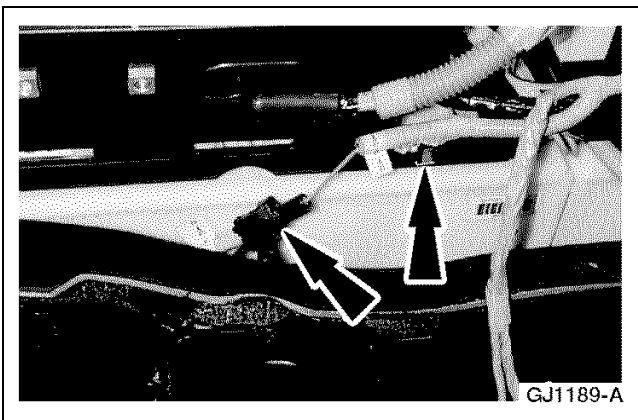

77. Connect the V sense lead connector.
- Clip the sensor lead onto the separator plate.

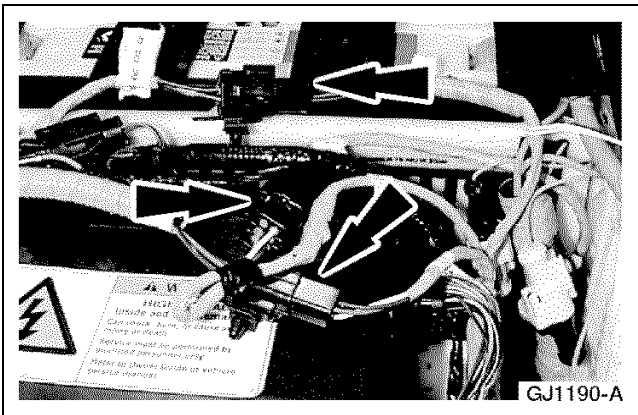

78. Connect the R, U, and W sense leads.

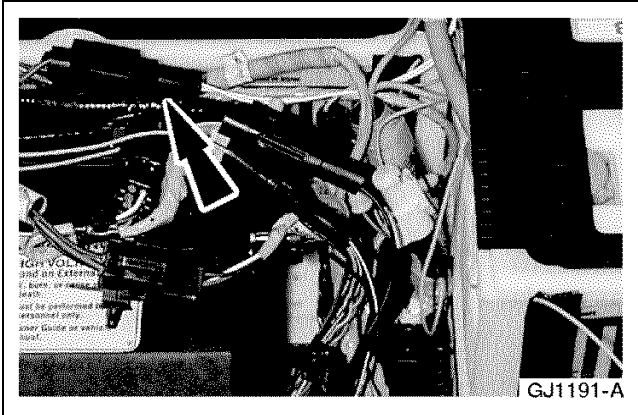
**DISASSEMBLY AND ASSEMBLY (Continued)**

79. Connect the temperature sensor to the 2- battery module.

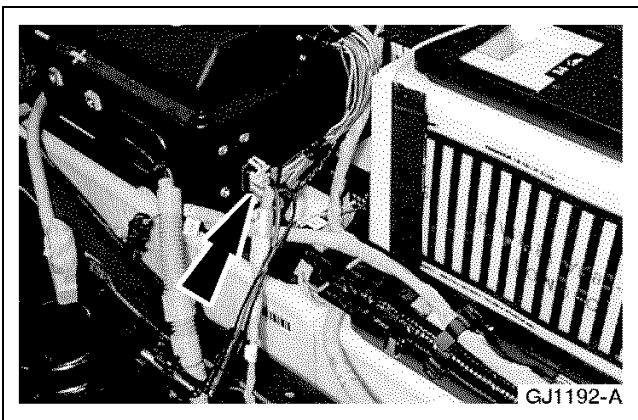

80. Connect the heater harness connector to the contactor box.

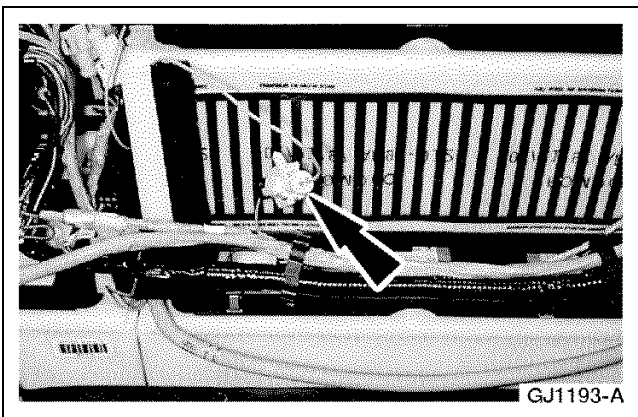

81. Connect the heating element connector to the heater harness, located on the side of battery module 2.

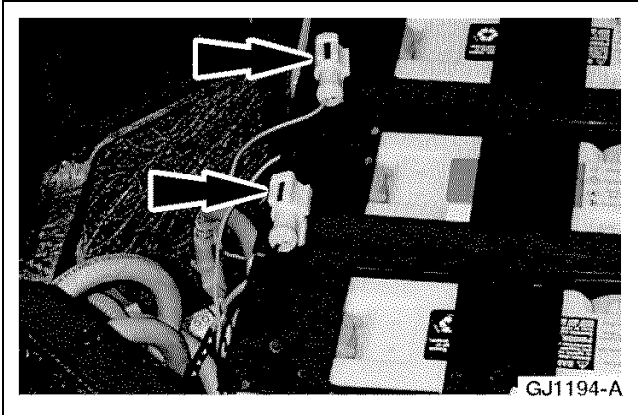
**DISASSEMBLY AND ASSEMBLY (Continued)**

82. Connect the two heating element connectors to the harness and clip them into the separator plate.

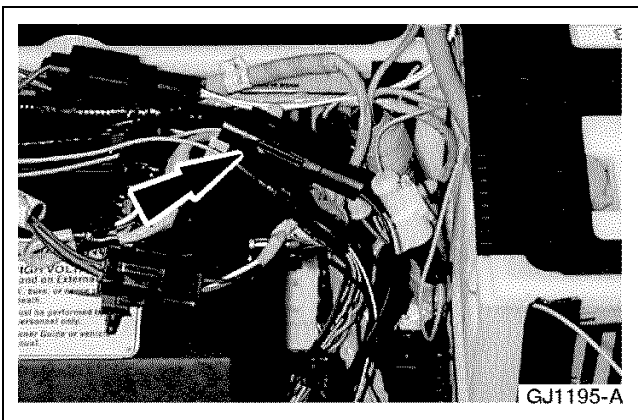

83. Connect the heating element connector to the harness.

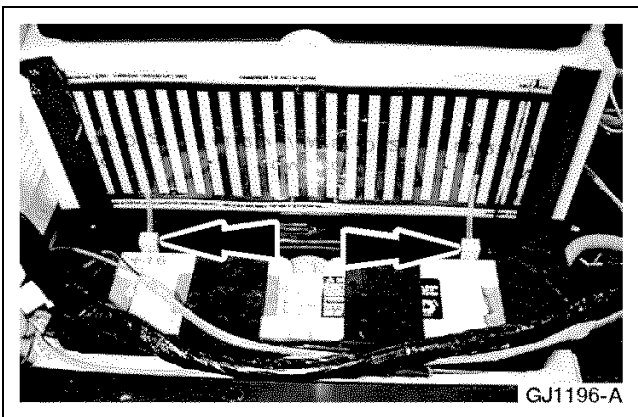

84. Position the heater harness down the center of the battery around the LH front battery modules.
85. Install two clips into the LH front separator plate.
- Place a zip tie through each of the clips.

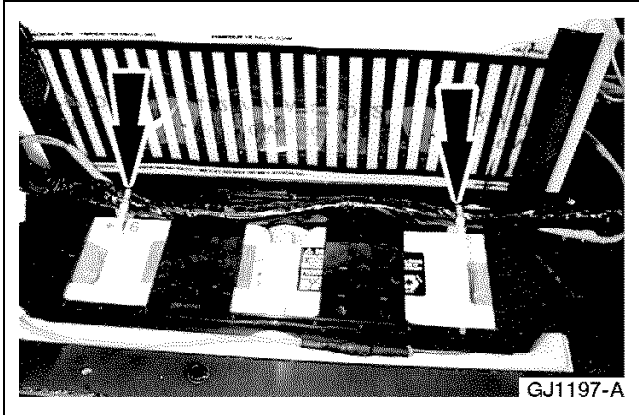
**DISASSEMBLY AND ASSEMBLY (Continued)**

86. Position the heater harness and low-voltage harness across the separator plate and zip tie them into place.

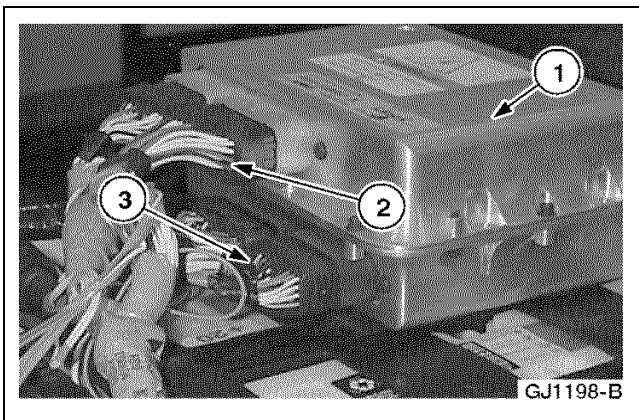

87. **NOTE:** The battery module is held into place with strips of Velcro™.

Install the BCM.

- 1 Position the BCM.
- 2 Connect the two upper high-voltage connectors.
- 3 Connect the two lower low-voltage connectors.

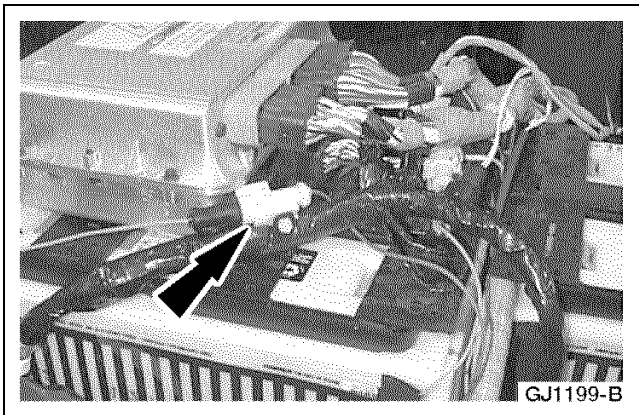

88. Clip the heating element connector into the low-voltage harness.

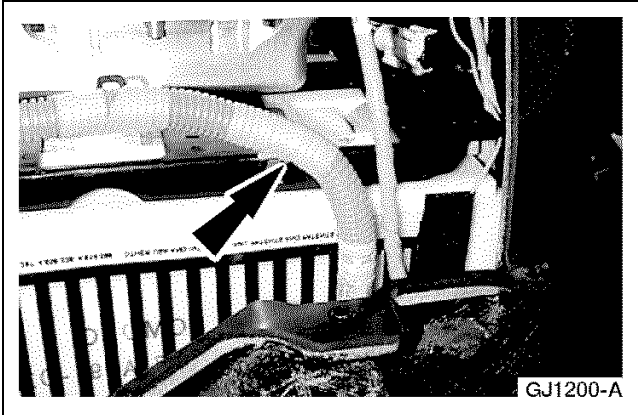

**DISASSEMBLY AND ASSEMBLY (Continued)**

89. Clip the contactor box jumper harness into the separator plate.

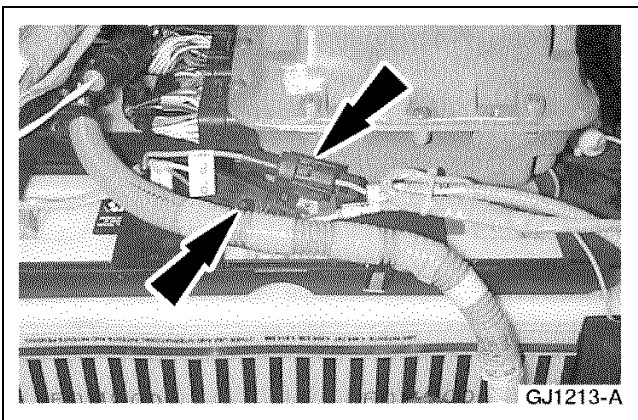

90. Connect the P and M sense lead connectors.
- Clip the P sense lead connector into the high-voltage harness.

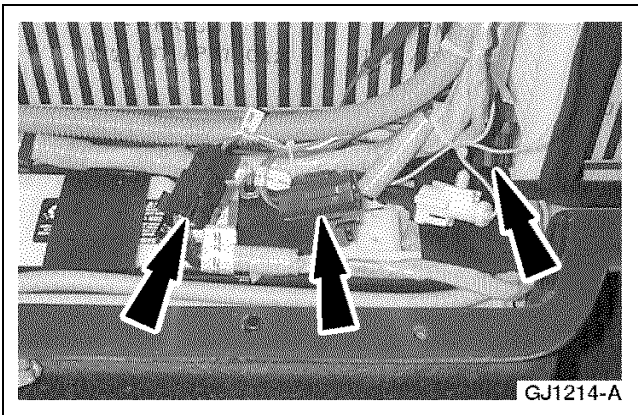

91. Connect the E, F, and N sense lead connectors.
- Clip the F and N connectors into the high-voltage harness.
  - Clip the E connector into the separator plate.

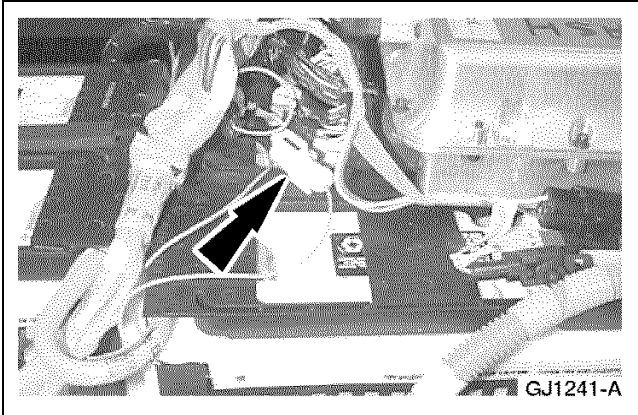
**DISASSEMBLY AND ASSEMBLY (Continued)**

92. Connect the heating element electrical connector and clip it into the BCM harness.

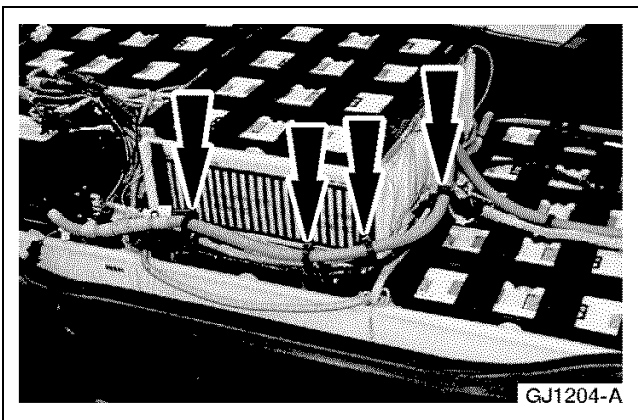

93. Position the contactor box harness.
- Clip the contactor box harness into the four high-voltage harness clips.

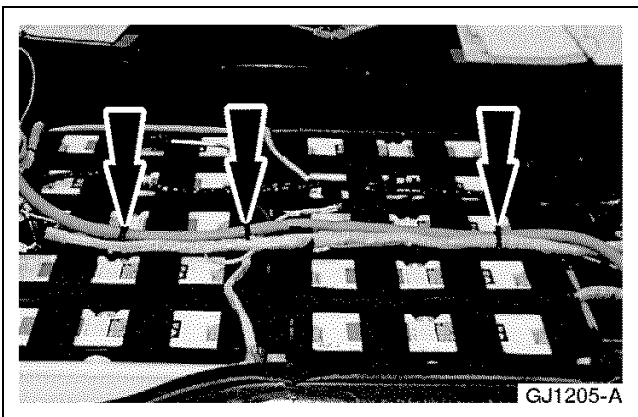

94. Clip the three contactor box harness clips into the separator plate.

## DISASSEMBLY AND ASSEMBLY (Continued)

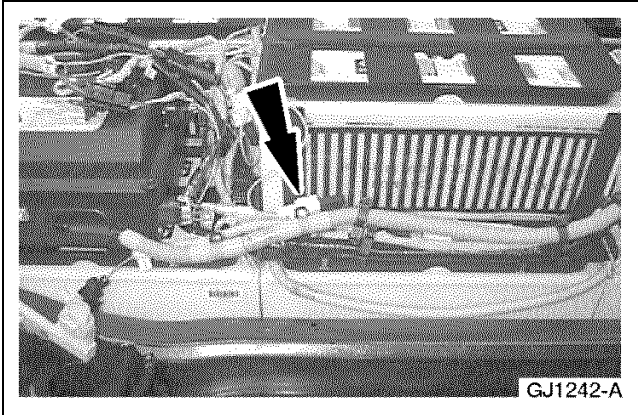

95. Clip the heating element connector into the contactor box harness.

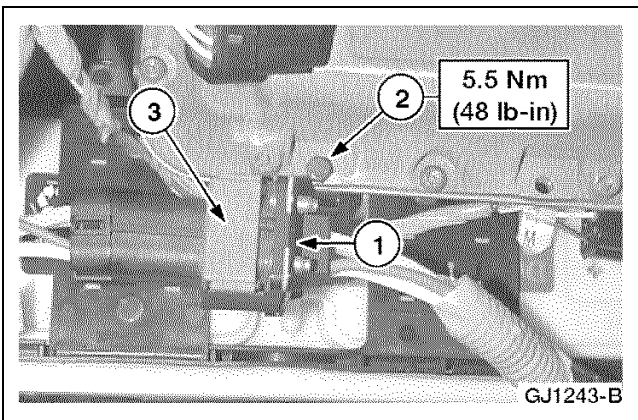

96. Connect the contactor box harness to the HVJ.
- 1 Position the bracket.
  - 2 Install the screw.
  - 3 Connect the harness to the jumper.

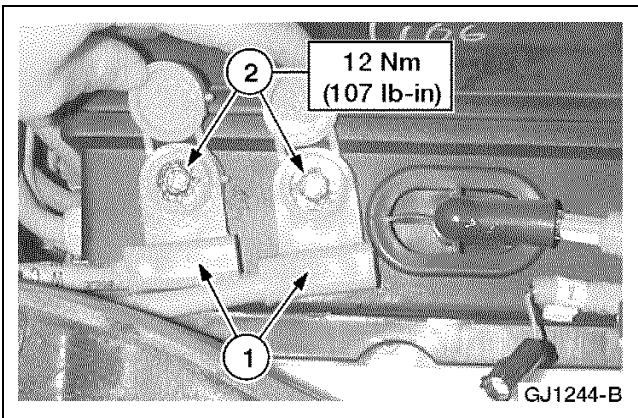

97. Connect the HVJs to the contactor box. The traction battery is now energized.
- 1 Position the HVJs.
  - 2 Install the bolts.

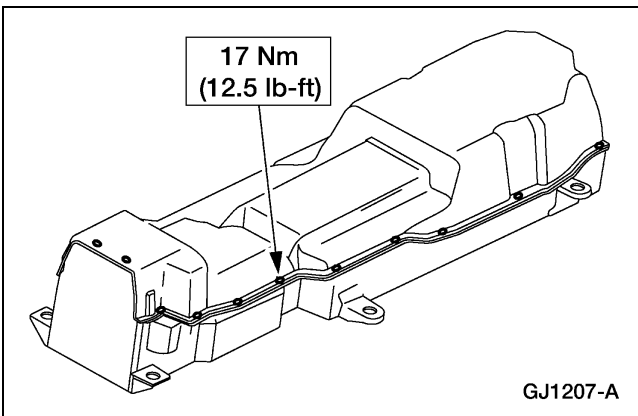

98. Install the traction battery cover.
- 1 Position the cover.
  - 2 Install the 22 bolts.
    - Apply Loctite 242 (Threadlock and Sealer) to the bolts prior to installation.

---

**Manual Table of Contents**

## SECTION 414-03B High Voltage/Traction Battery —Nickel Metal Hydride

**VEHICLE APPLICATION:** Ranger EV

<b>CONTENTS</b>	<b>PAGE</b>
<b>SPECIFICATIONS</b> .....	414-03B-3
<b>DESCRIPTION AND OPERATION</b>	
High Voltage/Traction Battery .....	414-03B-4
<b>DIAGNOSIS AND TESTING</b>	
Auxiliary Contactor Relay Control .....	414-03B-6
Electrical Schematic .....	414-03B-6
Inspection and Verification .....	414-03B-6
Pinpoint Tests .....	414-03B-6
Symptom Chart .....	414-03B-6
Contactor Box Current Sensors .....	414-03B-22
Electrical Schematic .....	414-03B-22
Inspection and Verification .....	414-03B-22
Pinpoint Tests .....	414-03B-22
Symptom Chart .....	414-03B-22
Current Leakage Detection .....	414-03B-25
Electrical Schematic .....	414-03B-25
Inspection and Verification .....	414-03B-25
Pinpoint Tests .....	414-03B-26
Symptom Chart .....	414-03B-26
Emergency Power Off (EPO)/Interlock System .....	414-03B-18
Electrical Schematic .....	414-03B-18
Inspection and Verification .....	414-03B-18
Pinpoint Tests .....	414-03B-19
Symptom Chart .....	414-03B-18
Main/Precharge Contactor Relay Control .....	414-03B-11
Electrical Schematic .....	414-03B-11
Inspection and Verification .....	414-03B-11
Pinpoint Tests .....	414-03B-12
Symptom Chart .....	414-03B-11
Multiple Auxiliary Load Failure Diagnosis .....	414-03B-79
Electrical Schematic .....	414-03B-79
Inspection and Verification .....	414-03B-79
Pinpoint Tests .....	414-03B-79
Symptom Chart .....	414-03B-79
Negative Contactor Relay Control .....	414-03B-16
Electrical Schematic .....	414-03B-16
Inspection and Verification .....	414-03B-16
Pinpoint Tests .....	414-03B-16
Symptom Chart .....	414-03B-16
Regenerative Braking .....	414-03B-37
Electrical Schematic .....	414-03B-37
Inspection and Verification .....	414-03B-37
Pinpoint Tests .....	414-03B-38
Symptom Chart .....	414-03B-38
Traction Battery Charging/Heating System .....	414-03B-40
Electrical Schematic .....	414-03B-41

<b>CONTENTS</b>	<b>PAGE</b>
Inspection and Verification .....	414-03B-42
Pinpoint Tests .....	414-03B-43
Symptom Chart .....	414-03B-42
Traction Battery Cooling/Ventilation System .....	414-03B-63
Electrical Schematic .....	414-03B-63
Inspection and Verification .....	414-03B-63
Pinpoint Tests .....	414-03B-63
Symptom Chart .....	414-03B-63
Traction Battery System .....	414-03B-69
Battery Module Diagnostic Test .....	414-03B-69
Electrical Schematic .....	414-03B-71
Inspection and Verification .....	414-03B-71
Pinpoint Tests .....	414-03B-72
Symptom Chart .....	414-03B-71
<b>GENERAL PROCEDURES</b>	
Battery Tray Seal .....	414-03B-92
Module Charging .....	414-03B-93
Traction Battery Module Replacement .....	414-03B-80
Traction Battery Tray Repair .....	414-03B-88
<b>REMOVAL AND INSTALLATION</b>	
Battery Control Module (BCM) .....	414-03B-94
Charge Inlet .....	414-03B-96
Contactor Box .....	414-03B-99
Contactor Box Fuses .....	414-03B-103
Flow Through Blower .....	414-03B-124
HVPDB Fuses .....	414-03B-105
High Voltage Power Distribution Box (HVPDB) .....	414-03B-107
High Voltage Wiring .....	414-03B-113
High Voltage Wiring —Sensor Lead Harness (10B694) .....	414-03B-108
Independent Observer Module —(IOM) .....	414-03B-171
Recirculating Blower .....	414-03B-126
Traction Battery .....	414-03B-116
Traction Battery Charger .....	414-03B-121
Traction Battery High Voltage Fuse (250A) .....	414-03B-131
Traction Battery Module —Modules 1, 7, 8, 9, 25 .....	414-03B-142
Traction Battery Module —Modules 10, 11, 12, 23, 24 .....	414-03B-149
Traction Battery Module —Modules 13-15 .....	414-03B-153
Traction Battery Module —Modules 16, 19, 20, 22 .....	414-03B-165
Traction Battery Module —Modules 17, 18, 21 .....	414-03B-158
Traction Battery Module —Modules 2-6 .....	414-03B-136
Traction Battery Temperature Sensor .....	414-03B-133
<b>DISASSEMBLY AND ASSEMBLY</b>	
Traction Battery .....	414-03B-174

## SPECIFICATIONS

### Torque Specifications

Description	Nm	Lb-Ft	Lb-In
A/C Inverter Motor Control Bolts	12	—	107
Battery Control Module Bolts	5	—	44
Battery Control Module/Independent Observer Module Bracket Bolts	5	—	44
Battery Control Module Multi-Pin Connector Bolts	3	—	27
Battery Hold Down Bolts	14	10	—
Battery Hold Down Strap Bolts	5	—	44
Charger Inlet Bracket Bolts	7	—	62.5
Composite Bar Bolts	5	—	44
Contactors Box Screws	2	—	18
Flow Through Blower Cover Bolts	12	—	107
Flow Through Blower Bracket Bolts	3	—	27
Flow Through Blower Nuts	6	—	53
Grille Screws	1.5	—	13.5
Ground Strap Bolt	12	—	107
Harness Bracket Bolt	5.4	—	48
High-Voltage Fuse Bolts	12	—	107
High-Voltage Jumper to Battery Module Nuts	12	—	107

(Continued)

### Torque Specifications

Description	Nm	Lb-Ft	Lb-In
High-Voltage Power Distribution Box Bolts	12	—	107
High-Voltage Power Distribution Box Cover Screws	2	—	18
High-Voltage Power Distribution Box Fuse Safety Cover Screws	2	—	18
Recirculating Blower Cover Bolts	14	—	10
Recirculating Blower Bracket Bolts	3	—	27
Recirculating Blower Nuts	6	—	53
Traction Battery Charger Bolts	22	16	—
Traction Battery Cover Bolts	17	12.5	—
Traction Battery Mounting Bolts	126	92.5	—
Two-Pin High-Voltage Connector Nuts	5	—	44.5
76-Pin Connector Bolt	4.8	—	43

### General Specifications

Item	Specification
Loctite 242 (Threadlock and Sealer) EOAZ-19554-AA	WSK-M2G351A5 (Type II)
Nyogel 760G	WSB-M1C239-A
Thermal Grease	ESF-M99G123-A

## DESCRIPTION AND OPERATION

### High Voltage/Traction Battery

The traction battery is the primary source of power for the Ranger EV. It is located between the frame rails and underneath the vehicle. The supporting tray contains all of the traction battery components. The tray is made of a strong, non-conductive composite material and has brackets molded into it at various locations. The traction battery, when fully loaded with all necessary components, weighs 595 kg (1,310 lb). The NiMH traction battery components are not interchangeable with the lead acid traction battery components. The NiMH traction battery is identified by its green label.

The traction battery contains 25 nickel metal hydride battery modules, a battery controller module (BCM), the independent observer module (IOM), a contactor box, a cooling system, and all necessary wiring. The 25 battery modules are wired together in series in order to achieve the necessary 300 volts (nominal) of direct current (DC) required for vehicle operation. The BCM and the IOM are located in the front end of the pack. The contactor box is in the rear end of the pack. The cooling system uses two blowers to circulate fresh, cool air through the battery pack. The flow through blower, which is mounted in the front of the battery pack, brings fresh air into the pack. The recirculating blower is located in the center of the battery pack and circulates air throughout the battery pack.

The traction battery uses a combination of high and low-voltage wiring. The high-voltage wiring is identified by its orange color or orange wrapping. The high-voltage circuit is protected by a 500 volt, 250 amp fuse. The low-voltage harness serves as an interface with the rest of the vehicle. This harness connects the vehicle through the 76-pin connector, located on the LH front of the traction battery.

#### Contacting Box

The contactor box contains relays that switch the high-voltage on and off. The relays shut off high-voltage when the ignition key is in the OFF position, when the vehicle is being charged, or when the inertia switch has been tripped. The contactor box also contains the pre-charge circuits, battery pack current sensing circuitry, and fuses to protect the charger, and high-voltage auxiliary circuits.

#### Battery Controller Module (BCM)

The BCM is a combination low and high-voltage module that controls all traction battery system operations. The BCM monitors selected battery module temperatures, state of charge for the 25 battery modules, and controls traction battery charging and cooling. The module also calculates the maximum source and sink currents to ensure safe and reliable pack performance.

#### High Voltage Power Distribution Box (HVPDB)

The HVPDB is located on top of the traction battery charger in the underhood compartment. The HVPDB distributes high-voltage to the DC/DC converter, vehicle heating system, air conditioning system, power steering system, and the traction battery charger. The box contains fuses to protect the circuits to which the high-voltage is supplied. The box uses a protective cover that is part of the interlock circuit. When the cover is removed, a limit switch will open the relays in the contactor box to interrupt high-voltage to the vehicle.

#### Independent Observer Module (IOM)

The IOM is a module that monitors the traction battery temperature during charging using its own independent thermistors. In the event that the IOM detects a battery pack over-temperature condition, it will interrupt the pilot signal to the BCM. This event will cause an interruption of vehicle charging. Pilot signal from the PCS of the IOM is as follows:

- When the vehicle is plugged into the power control station PCS, a squarewave pilot signal is sent through the charge cord to the IOM via the charge inlet.
- If the IOM determines that the battery temperature is within normal charging parameters, it allows the pilot signal to pass to the onboard battery charger and then to the BCM.
- The BCM receives the signal from the charge inlet door switch notifying it that the vehicle has been plugged in.
- Once the BCM receives the plugged in signal from the charge inlet door switch, it sends fault detection signals to the IOM to determine if there are any faults.

## DESCRIPTION AND OPERATION (Continued)

- If the BCM receives a normal fault detection signal (no faults present) from the IOM, it activates the onboard charger and the traction battery is charged.

### Operation During Over Temperature Conditions

In the event an IOM temperature sensor detects an over-temperature or a rapid rise in temperature, it will interrupt the pilot signal and prevent the BCM from activating the onboard charger.

In the event an over-temperature condition occurs that does not include a rapid temperature rise, charging will be interrupted but no DTC will be set. Charging will resume once the battery pack temperature returns to normal.

If an IOM temperature sensor registers 49 degrees Celsius (120 degrees Fahrenheit) or greater, an over-temperature condition will be identified. The over-temperature condition will exist until the lowest temperature sensor reading is at or below 45 degrees Celsius (113 degrees Fahrenheit).

The BCM will suspend traction battery charging if any BCM temperature sensor exceeds 45 degrees Celsius (113 degrees Fahrenheit). The BCM will allow charging to resume once the lowest BCM temperature sensor reading is at or below 42 degrees Celsius (108 degrees Fahrenheit).

If the cause of the interruption is a rapid rise in temperature or an open or shorted temperature sensor, a signal will be sent from the IOM to the BCM indicating a fault condition. This will cause the BCM to store a DTC. The parameter for a rapid rise in temperature is two degrees Celsius (3.6 degrees Fahrenheit) within six minutes at any IOM temperature sensor.

- An interruption of the pilot signal will be detected using the OPSTATE\_PID referred to in the diagnostic procedures in this section.
- If a DTC is sent in the BCM by the IOM because of a rapid rise in temperature or sensor fault, the IOM will be **latched**.
- Once latched, the IOM will prevent charging until it is **unlatched**.

- To unlatch the IOM, the auxiliary battery negative cable must be removed for 30 seconds. Once this is done, the vehicle will again charge normally.
- After unlatching, the DTC must still be cleared from the BCM memory using a scan tool.
- If, after unlatching the IOM, the fault resets immediately, the source of the concern is likely a failed temperature sensor or its circuit.
- After the IOM has been unlatched, if the fault resets after the vehicle has been charging for some time, the source is likely a rapid rise in temperature.

**NOTE:** Using a scan tool to monitor the BCM temperatures should allow the concern to be verified.

**NOTE:** The vehicle will be unable to continue charging if the IOM goes into a latched condition. Repair the source of the fault before resuming traction battery charging.

**NOTE:** Most all concerns with the IOM are sensor related.

### Emergency Power Off (EPO) / Interlock System

The Electric Ranger is equipped with a power off system that operates in a manner similar to that of a gasoline powered vehicle. When the inertia switch is triggered, the EPO is activated and the contactor box will disable all vehicle power. The power reset light will illuminate to indicate that this situation exists. The inertia switch must be reset before the contactor box will re-activate the vehicle power.

### Leakage Detection

The battery controller module (BCM) monitors current leakage between traction battery positive and negative terminals and the vehicle chassis. If the leakage resistance drops below 50 k ohms, the BCM will request the interface adapter assembly (IAA) to illuminate the electrical hazard warning light. The BCM monitors the leakage rate once every 20 seconds to ensure safety against electrical hazards and to ensure that it is safe to charge the vehicle.



## DIAGNOSIS AND TESTING

### Auxiliary Contactor Relay Control

#### Diagnostic Trouble Code (DTC) Definition

The following DTC relates to the control of the auxiliary contactor relay:

- DTC C1862 Contactor Circuit Failure
  - The interface adapter assembly (IAA) module controls the auxiliary contactor relay to provide high-voltage power to the high-voltage auxiliary loads. The IAA module closes the auxiliary contactor relay when the ignition key is turned to the ON position and monitors its status through a feedback line from the contactor box. The IAA module sets DTC C1862 if it detects the auxiliary contactor relay open when it should be closed and closed when it should be open.

#### Electrical Schematic

Refer to Electrical and Vacuum Troubleshooting Manual, Cell 21, Contactor Box Relay Control for schematic and connector information.

#### Inspection and Verification

Refer to [Section 100-07](#).

### Symptom Chart

#### Symptom Chart

Condition	Possible Sources	Action
<ul style="list-style-type: none"> <li>• DTC C1862 Contactor Circuit Failure</li> </ul>	<ul style="list-style-type: none"> <li>• Circuit(s).</li> <li>• Interface adapter assembly (IAA) module.</li> <li>• High-voltage power distribution box (HVPDB).</li> <li>• Contactor box.</li> <li>• Contactor box high-voltage fuse.</li> </ul>	<ul style="list-style-type: none"> <li>• GO to Pinpoint Test A.</li> </ul>

### Pinpoint Tests

#### Special Tool(s)

104-Pin Breakout Box (BOB) 418-049 (014-00950) or equivalent
Traction Battery High-Voltage Service Cord 418-F218
Traction Battery Low-Voltage Service Cord 418-F219

(Continued)

#### Special Tool(s)

Traction Battery High-Voltage Lockout and Diagnostic Tool 418-F207
High-Voltage Insulated Safety Gloves 100-F036 or equivalent
Face Shield 100-F035 or equivalent

**DIAGNOSIS AND TESTING (Continued)****PINPOINT TEST A: DTC C1862 CONTACTOR CIRCUIT FAILURE**

TEST STEP	ACTION TO TAKE
<p><b>A1 CHECK FOR INTERFACE ADAPTER ASSEMBLY (IAA) MODULE AND TRACTION INVERTER MODULE (TIM) DIAGNOSTIC TROUBLE CODES (DTCs)</b></p> <p><b>NOTE:</b> Do not go to test step A2 unless there is a multiple auxiliary load failure and DTC C1862 occurs after the IAA module on-demand self-test is carried out.</p> <ul style="list-style-type: none"> <li>Retrieve continuous DTCs from the TIM and carry out the on-demand self-test for the IAA module.</li> <li><b>Do IAA module DTCs C1862 Contactor Circuit Failure and U2015 Signal Link Fault (Non SCP), and TIM DTC B1676 Battery Pack Voltage Out of Range all occur?</b></li> </ul>	<p>Yes = REFER to Pinpoint Test A in Main/Precharge Contactor Relay Control in this section.</p> <p>No = GO to A2.</p>
<p><b>A2 CHECK HIGH-VOLTAGE AUXILIARY BUS STATUS</b></p> <ul style="list-style-type: none"> <li>With key ON, monitor IAA module PID AUXHVB.</li> <li><b>Does the AUXHVB PID indicate AVAILA?</b></li> </ul>	<p>Yes = GO to A3.</p> <p>No = If AUXHVB PID indicates UNAVAI, RETRIEVE DTCs from the battery control module (BCM). REFER to Section 100-07. If AUXHVB PID indicates EPO or INERSW, REFER to Emergency Power Off (EPO)/Interlock System in this section.</p>
<p><b>A3 CHECK AUXILIARY CONTACTOR RELAY STATUS</b></p> <ul style="list-style-type: none"> <li>With key ON, monitor IAA module PID AUX__HVC.</li> <li><b>Does the AUX__HVC PID indicate CLOSED?</b></li> </ul>	<p>Yes = System OK. CHECK wiring for intermittent connections.</p> <p>No = If AUX__HVC PID indicates OPEN, GO to A4. If AUX__HVC PID indicates OFAULT, GO to A6.</p>
<p><b>A4 CHECK CHARGER CORD STATUS</b></p> <p><b>NOTE:</b> Verify the power control station (PCS) charger cord is not plugged into the charger inlet before carrying out this test step.</p> <ul style="list-style-type: none"> <li>With key OFF, monitor BCM PID CHGCORD.</li> <li><b>Does the CHGCORD PID indicate OUT?</b></li> </ul>	<p>Yes = GO to A5.</p> <p>No = RETRIEVE DTCs from the BCM. REFER to Section 100-07.</p>
<p><b>A5 VERIFY AVAILABILITY OF AUXILIARY HIGH-VOLTAGE BUS</b></p> <ul style="list-style-type: none"> <li>With key ON, monitor IAA module PID AUXHVB.</li> <li><b>Does the AUXHVB PID indicate AVAILA?</b></li> </ul>	<p>Yes = REPLACE the IAA module. REFER to Section 412-04.</p> <p>No = RETRIEVE DTCs from the BCM. REFER to Section 100-07.</p>
<p><b>A6 CHECK AUXILIARY CONTACTOR RELAY FAULT STATUS</b></p> <ul style="list-style-type: none"> <li>Enter IAA module active command mode AUXILIARY SYSTEM CONTROL, monitor IAA module PID AUX__HVC, and set the active command AUX CONT to CLOSE.</li> <li>After the CLOSE signal is complete, set the active command AUX CONT to OPEN.</li> <li><b>Does the AUX__HVC PID indicate CLOSED?</b></li> </ul>	<p>Yes = System OK. CHECK wiring for intermittent connections.</p> <p>No = If AUX__HVC PID indicates CFAULT, GO to A7.</p>

(Continued)

**DIAGNOSIS AND TESTING (Continued)****PINPOINT TEST A: DTC C1862 CONTACTOR CIRCUIT FAILURE**

TEST STEP	ACTION TO TAKE
	If AUX__HVC PID indicates OFAULT, GO to <b>A14</b> .
<b>A7 CHECK AUXILIARY CONTACTOR RELAY CONTROL SIGNAL (CLOSE FAULT)</b> <ul style="list-style-type: none"> <li>• Connect 104-Pin Breakout Box (BOB) to IAA module and IAA module C1945.</li> <li>• Enter IAA module active command mode AUXILIARY SYSTEM CONTROL, set the active command AUX CONT to OPEN, and measure the voltage between BOB pin 42 and ground (BOB pin 80).</li> <li>• <b>Is the voltage less than 1 volt?</b></li> </ul>	Yes = GO to <b>A10</b> . No = GO to <b>A8</b> .
<b>A8 CHECK CIRCUIT 3998 (GY) FOR SHORT TO POWER</b> <ul style="list-style-type: none"> <li>• Disconnect BOB from IAA module; leave BOB connected to IAA module C1945.</li> <li>• With key ON, measure the voltage between BOB pin 42 and ground (BOB pin 80).</li> <li>• <b>Is the voltage greater than 0 volts?</b></li> </ul>	Yes = GO to <b>A9</b> . No = REPLACE the IAA module. REFER to Section 412-04.
<b>A9 CHECK CIRCUIT 3998 (GY) BETWEEN IAA MODULE AND TRACTION BATTERY SUPPORT TRAY FOR SHORT TO POWER</b> <ul style="list-style-type: none"> <li>• With key OFF, disconnect traction battery support tray in-line C1939.</li> <li>• With key ON, measure the voltage between BOB pin 42 and ground (BOB pin 80).</li> <li>• <b>Is the voltage greater than 0 volts?</b></li> </ul>	Yes = REPAIR the GY wire between the IAA module and in-line C1939M. No = REMOVE the traction battery and REPAIR the GY wire between the contactor box and in-line C1939F.
<b>A10 CHECK AUXILIARY CONTACTOR RELAY STATUS SIGNAL (CLOSE FAULT)</b> <ul style="list-style-type: none"> <li>• Enter IAA module active command mode AUXILIARY SYSTEM CONTROL, set the active command AUX CONT to OPEN, and measure the voltage between BOB pin 26 and ground (BOB pin 80).</li> <li>• <b>Is the voltage greater than 10 volts?</b></li> </ul>	Yes = GO to <b>A11</b> . No = GO to <b>A13</b> .
<b>A11 CHECK CIRCUIT 3999 (DB/LG) BETWEEN IAA MODULE AND TRACTION BATTERY SUPPORT TRAY FOR SHORT TO POWER</b> <ul style="list-style-type: none"> <li>• Disconnect BOB from IAA module; leave BOB connected to IAA module C1945.</li> <li>• With key OFF, disconnect traction battery support tray in-line C1939.</li> <li>• With key ON, measure the voltage between BOB pin 26 and ground (BOB pin 80).</li> <li>• <b>Is the voltage greater than 0 volts?</b></li> </ul>	Yes = REPAIR the DB/LG wire between the IAA module and in-line C1939M. No = GO to <b>A12</b> .
<b>A12 CHECK CIRCUIT 3999 (DB/LG) BETWEEN CONTACTOR BOX AND TRACTION BATTERY SUPPORT TRAY FOR SHORT TO POWER</b> <ul style="list-style-type: none"> <li>• Disconnect BOB from IAA module C1945.</li> <li>• Remove the traction battery and connect Traction Battery High-Voltage Lockout and Diagnostic Tool to traction battery high-voltage two-pin C3994M.</li> </ul>	Yes = REPAIR the DB/LG wire between the contactor box and in-line C1939F. No = REPLACE the contactor box.

(Continued)

**DIAGNOSIS AND TESTING (Continued)****PINPOINT TEST A: DTC C1862 CONTACTOR CIRCUIT FAILURE**

TEST STEP	ACTION TO TAKE
<p> <b>WARNING: The traction battery contains high-voltage components and wiring. High-voltage insulated safety gloves and face shield must be worn when carrying out the following steps. Failure to follow this warning may result in severe personal injury or death.</b></p> <ul style="list-style-type: none"> <li>• Connect Traction Battery High-Voltage Service Cord to traction battery support tray in-line C1935F and in-line C1935M.</li> <li>• Connect BOB to traction battery support tray in-line C1939F using Traction Battery Low-Voltage Service Cord; do not connect Traction Battery Low-Voltage Service Cord to in-line C1939M.</li> <li>• With key OFF, disconnect contactor box C1982.</li> <li>• With key ON, measure the voltage between BOB pin 17 and ground (BOB pin 65).</li> <li>• <b>Is the voltage greater than 0 volts?</b></li> </ul>	
<p><b>A13 CHECK AUXILIARY CONTACTOR RELAY FEEDBACK STATUS</b></p> <ul style="list-style-type: none"> <li>• With key ON, monitor IAA module AUXCN_I.</li> <li>• <b>Does the AUXCN_I PID indicate ENABLED?</b></li> </ul>	<p>Yes = REPLACE the IAA module. REFER to Section 412-04.</p> <p>No = System OK. CHECK wiring for intermittent connections.</p>
<p><b>A14 CHECK AUXILIARY CONTACTOR RELAY STATUS SIGNAL (OPEN FAULT)</b></p> <ul style="list-style-type: none"> <li>• Connect 104-Pin Breakout Box (BOB) to IAA module and IAA module C1945.</li> <li>• Enter IAA module active command mode AUXILIARY SYSTEM CONTROL, set the active command AUX CONT to CLOSE, and measure the voltage between BOB pin 26 and ground (BOB pin 80).</li> <li>• <b>Is the voltage greater than 10 volts?</b></li> </ul>	<p>Yes = System OK. CHECK wiring for intermittent connections.</p> <p>No = GO to <b>A15</b>.</p>
<p><b>A15 CHECK AUXILIARY CONTACTOR RELAY CONTROL SIGNAL (OPEN FAULT)</b></p> <ul style="list-style-type: none"> <li>• Enter IAA module active command mode AUXILIARY SYSTEM CONTROL, set the active command AUX CONT to CLOSE, and measure the voltage between BOB pin 42 and ground (BOB pin 80).</li> <li>• <b>Is the voltage greater than 10 volts?</b></li> </ul>	<p>Yes = GO to <b>A18</b>.</p> <p>No = GO to <b>A16</b>.</p>
<p><b>A16 CHECK CIRCUIT 3998 (GY) FOR SHORT TO GROUND</b></p> <ul style="list-style-type: none"> <li>• Disconnect BOB from IAA module; leave BOB connected to IAA module C1945.</li> <li>• With key OFF, measure the resistance between BOB pin 42 and ground (BOB pin 80).</li> <li>• <b>Is the resistance greater than 10,000 ohms?</b></li> </ul>	<p>Yes = REPLACE the IAA module. REFER to Section 412-04.</p> <p>No = GO to <b>A17</b>.</p>
<p><b>A17 CHECK CIRCUIT 3998 (GY) BETWEEN IAA MODULE AND TRACTION BATTERY SUPPORT TRAY FOR SHORT TO GROUND</b></p> <ul style="list-style-type: none"> <li>• With key OFF, disconnect traction battery support tray in-line C1939.</li> <li>• With key OFF, measure the resistance between BOB pin 42 and ground (BOB pin 80).</li> <li>• <b>Is the resistance greater than 10,000 ohms?</b></li> </ul>	<p>Yes = REMOVE the traction battery and REPAIR the GY wire between the contactor box and in-line C1939F.</p> <p>No = REPAIR the GY wire between the IAA module and in-line C1939M.</p>
<p><b>A18 CHECK CIRCUITS 3998 (GY) AND 3999 (DB/LG) BETWEEN IAA MODULE AND TRACTION BATTERY SUPPORT TRAY FOR OPEN(S)</b></p>	

(Continued)

**DIAGNOSIS AND TESTING (Continued)****PINPOINT TEST A: DTC C1862 CONTACTOR CIRCUIT FAILURE**

<b>TEST STEP</b>	<b>ACTION TO TAKE</b>
<ul style="list-style-type: none"> <li>• With key OFF, disconnect traction battery support tray in-line C1939 and measure the resistance of the GY wire between pin 16 on in-line C1939M and BOB pin 42.</li> <li>• With key OFF, measure the resistance of the DB/LG wire between pin 17 on in-line C1939M and BOB pin 26.</li> <li>• <b>Are the resistances less than 5 ohms?</b></li> </ul>	<p>Yes = GO to <b>A19</b>.</p> <p>No = REPAIR the wire(s) in question.</p>
<p><b>A19 CHECK CIRCUIT 3999 (DB/LG) BETWEEN IAA MODULE AND TRACTION BATTERY SUPPORT TRAY FOR SHORT TO GROUND</b></p> <ul style="list-style-type: none"> <li>• Disconnect BOB from IAA module; leave BOB connected to IAA module C1945.</li> <li>• With key OFF, measure the resistance between BOB pin 26 and ground (BOB pin 80).</li> <li>• <b>Is the resistance greater than 10,000 ohms?</b></li> </ul>	<p>Yes = GO to <b>A20</b>.</p> <p>No = REPAIR the DB/LG wire.</p>
<p><b>A20 CHECK CIRCUITS 3998 (GY) AND 3999 (DB/LG) BETWEEN CONTACTOR BOX AND TRACTION BATTERY SUPPORT TRAY FOR OPEN(S)</b></p> <ul style="list-style-type: none"> <li>• Disconnect BOB from IAA module C1945; do not reconnect IAA module C1945.</li> <li>• Remove the traction battery.</li> </ul> <p><b>⚠ WARNING: The traction battery contains high-voltage components and wiring. High-voltage insulated safety gloves and face shield must be worn when carrying out the following steps. Failure to follow this warning may result in severe personal injury or death.</b></p> <ul style="list-style-type: none"> <li>• Connect BOB to traction battery support tray in-line C1939F using Traction Battery Low-Voltage Service Cord; do not connect Traction Battery Low-Voltage Service Cord to in-line C1939M.</li> <li>• With key OFF, disconnect contactor box C1982 and measure the resistance of the GY wire between pin 19 on contactor box C1982 and BOB pin 16.</li> <li>• With key OFF, measure the resistance of the DB/LG wire between pin 1 on contactor box C1982 and BOB pin 17.</li> <li>• <b>Are the resistances less than 5 ohms?</b></li> </ul>	<p>Yes = GO to <b>A21</b>.</p> <p>No = REPAIR the wire(s) in question.</p>
<p><b>A21 CHECK CIRCUIT 3999 (DB/LG) BETWEEN CONTACTOR BOX AND TRACTION BATTERY SUPPORT TRAY FOR SHORT TO GROUND</b></p> <ul style="list-style-type: none"> <li>• With key OFF, measure the resistance between BOB pin 17 and ground (BOB pin 65).</li> <li>• <b>Is the resistance greater than 10,000 ohms?</b></li> </ul>	<p>Yes = GO to <b>A22</b>.</p> <p>No = REPAIR the DB/LG wire.</p>
<p><b>A22 CHECK HIGH-VOLTAGE AUXILIARY POSITIVE BUS FOR OPEN</b></p> <ul style="list-style-type: none"> <li>• Disconnect power steering assembly high-voltage C1895.</li> <li>• Measure the resistance between circuit 3140 (BK wire) on power steering assembly C1895 and circuit 3132 (Y wire) on high-voltage auxiliary load in-line C1935M.</li> <li>• <b>Is the resistance less than 5 ohms?</b></li> </ul>	<p>Yes = GO to <b>A23</b>.</p> <p>No = REPLACE the HVPDB.</p>
<p><b>A23 CHECK CONTACTOR BOX HIGH-VOLTAGE FUSE</b></p> <ul style="list-style-type: none"> <li>• Remove the 40A AUX fuse from the contactor box. Refer to Contactor Box Fuses Removal and Installation procedure in this section.</li> <li>• Measure the resistance of the 40A AUX fuse.</li> <li>• <b>Is the resistance greater than 1,000 ohms?</b></li> </ul>	<p>Yes = REPLACE the 40A AUX fuse.</p> <p>No = REPLACE the contactor box.</p>

## DIAGNOSIS AND TESTING (Continued)

### Main/Precharge Contactor Relay Control

#### Diagnostic Trouble Code (DTC) Definition

The following DTCs relate to the contactor box relays that are controlled by the traction inverter module (TIM):

- DTC B1676 Battery Pack Voltage Out of Range
  - The TIM monitors the traction battery voltage at its high-voltage input terminals. The TIM receives high-voltage power when the contactor box main contactor relay closes. The TIM closes the main contactor relay after the precharge sequence is complete and the ignition key is turned to the START position with the gear selector in the P (Park) or N (Neutral) position. The TIM sets DTC B1676 when it detects the traction battery voltage is less than 50 volts or greater than 385 volts after the contactor box main contactor relay has been commanded closed. If this occurs, the TIM will shut down preventing the motor from being enabled and the malfunction indicator lamp (MIL) will illuminate.

- DTC C1862 Contactor Circuit Failure
  - The TIM controls two contactor box relays, the precharge and main contactor relays. There are capacitors at the high-voltage input to the TIM that are charged at a slow rate to a high-voltage level when the precharge contactor relay is closed. This prevents arcing and damage to the main contactor relay if the main contactor relay closes without precharge. The TIM closes the precharge contactor relay when the ignition key is turned to the ON position. The TIM sets DTC C1862 if the precharge sequence fails. If this occurs, the TIM will shut down preventing the motor from being enabled and the MIL will illuminate. The TIM also performs a test to determine if the main and/or precharge contactor relays are welded. The TIM sets DTC C1862 if welded contactor relay(s) have been detected. If this occurs, the TIM will allow the motor to be enabled and the MIL will illuminate. The TIM will also send a SCP message (main contactor relay welded/stuck closed) to the Battery Control Module (BCM) so the BCM will not allow charging.

#### Electrical Schematic

Refer to Electrical and Vacuum Troubleshooting Manual, Cell 21, Contactor Box Relay Control for schematic and connector information.

#### Inspection and Verification

Refer to [Section 100-07](#).

### Symptom Chart

#### Symptom Chart

Condition	Possible Sources	Action
<ul style="list-style-type: none"> <li>• DTC B1676 Battery Pack Voltage Out of Range</li> </ul>	<ul style="list-style-type: none"> <li>• Contactor box.</li> <li>• Circuit(s).</li> <li>• Traction inverter module (TIM).</li> <li>• Low voltage TIM fuses:               <ul style="list-style-type: none"> <li>— 9 (10A)</li> <li>— 11 (7.5A)</li> <li>— 24 (7.5A)</li> </ul> </li> <li>• Traction battery high-voltage fuse.</li> </ul>	<ul style="list-style-type: none"> <li>• GO to Pinpoint Test A.</li> </ul>
<ul style="list-style-type: none"> <li>• DTC C1862 Contactor Circuit Failure</li> </ul>	<ul style="list-style-type: none"> <li>• Circuit(s).</li> <li>• Traction inverter module (TIM).</li> <li>• Contactor box.</li> </ul>	<ul style="list-style-type: none"> <li>• GO to Pinpoint Test B.</li> </ul>

**DIAGNOSIS AND TESTING (Continued)**

**Pinpoint Tests**

**Special Tool(s)**

**Special Tool(s)**

104-Pin Breakout Box (BOB) 418-049 (014-00950) or equivalent
BCM/TIM Breakout Box (BOB) Adapter Cable 418-F212
BCM/TIM Breakout Box (BOB) Overlay 418-F220

Traction Battery Low-Voltage Service Cord 418-F219
Traction Battery High-Voltage Lockout and Diagnostic Tool 418-F207
High-Voltage Insulated Safety Gloves 100-F036 or equivalent
Face Shield 100-F035 or equivalent

(Continued)

**PINPOINT TEST A: DTC B1676 BATTERY PACK VOLTAGE OUT OF RANGE**

TEST STEP	ACTION TO TAKE
<p><b>A1 CHECK FOR INTERFACE ADAPTER ASSEMBLY (IAA) MODULE DIAGNOSTIC TROUBLE CODES (DTCs)</b></p> <p><b>NOTE:</b> Make sure low voltage TIM fuse(s) #9 (10A), #11 (7.5A), and #24 (7.5A) are good before performing test A1. If fuse(s) are OK, proceed with A1, if not, install new fuse(s) and perform test A1.</p> <p><b>NOTE:</b> Using High-Voltage Insulated Safety Gloves and Face Shield, disconnect and check the traction battery high-voltage two-pin C3994 for damage before carrying out the following test steps. Repair as necessary. If OK, reconnect and verify the connection is secure.</p> <ul style="list-style-type: none"> <li>Carry out the on-demand self-test for the IAA module.</li> <li><b>Do IAA module DTCs C1862 Contactor Circuit Failure and U2015 Signal Link Fault (Non SCP) occur?</b></li> </ul>	<p>Yes = GO to <b>A2</b>.</p> <p>No = GO to <b>A4</b>.</p>
<p><b>A2 CHECK GROUND TO CONTACTOR BOX</b></p> <ul style="list-style-type: none"> <li>With key OFF, disconnect traction battery support tray in-line C1939 and connect 104-Pin Breakout Box (BOB) to traction battery support tray in-line C1939M using Traction Battery Low-Voltage Service Cord; do not connect Traction Battery Low-Voltage Service Cord to in-line C1939F.</li> <li>With key OFF, measure the resistance between BOB pin 65 and ground.</li> <li><b>Is the resistance less than 5 ohms?</b></li> </ul>	<p>Yes = GO to <b>A3</b>.</p> <p>No = REPAIR the BK wire.</p>
<p><b>A3 CHECK CIRCUIT 57 (BK) FOR OPEN</b></p> <ul style="list-style-type: none"> <li>Disconnect the BOB from in-line C1939M and remove the traction battery.</li> </ul> <p><b>⚠ WARNING: The traction battery contains high-voltage components and wiring. High-voltage insulated safety gloves and face shield must be worn when carrying out the following steps. Failure to follow this warning may result in severe personal injury or death.</b></p> <ul style="list-style-type: none"> <li>Connect BOB to traction battery support tray in-line C1939F using Traction Battery Low-Voltage Service Cord.</li> <li>With key OFF, disconnect contactor box C1982 and measure the resistance between pin 8 (BK wire) on contactor box C1982 and BOB pin 65.</li> <li><b>Is the resistance less than 5 ohms?</b></li> </ul>	<p>Yes = REPLACE the contactor box.</p> <p>No = REPAIR the BK wire.</p>
<p><b>A4 CHECK STATUS OF HIGH-VOLTAGE POWER TO TIM</b></p> <ul style="list-style-type: none"> <li>With key ON, monitor TIM PID BAT_PV.</li> <li>Turn the ignition key to the START position.</li> <li><b>Does the BAT_PV PID indicate between 50 and 385 volts?</b></li> </ul>	<p>Yes = System OK. CHECK wiring for intermittent connections.</p> <p>No = If less than 50 volts, GO to <b>A5</b>. If greater than 385 volts, GO to <b>A12</b>.</p>

(Continued)

**DIAGNOSIS AND TESTING (Continued)****PINPOINT TEST A: DTC B1676 BATTERY PACK VOLTAGE OUT OF RANGE**

TEST STEP	ACTION TO TAKE
<p><b>A5 CHECK MAIN CONTACTOR RELAY</b></p> <p><b>NOTE:</b> The active command PRECHG IN must be sent before sending the active command POS MAIN. If not, New Generation STAR (NGS) Tester will indicate UNABLE TO PERFORM TEST/FUNCTION.</p> <ul style="list-style-type: none"> <li>• Enter the TIM active command mode CONTACTOR OUTPUT CONTROL, monitor the TIM PID BAT__PV, and set the active commands PRECHG IN and POS MAIN to CLOSE.</li> <li>• Set the active command PRECHG IN to OPEN.</li> <li>• <b>Does the BAT__PV PID indicate less than 50 volts?</b></li> </ul>	<p>Yes = GO to <b>A6</b>.</p> <p>No = GO to <b>A12</b>.</p>
<p><b>A6 CHECK TIM MAIN CONTACTOR CONTROL SIGNAL TO CONTACTOR BOX AT TRACTION BATTERY SUPPORT TRAY</b></p> <ul style="list-style-type: none"> <li>• With key OFF, disconnect traction battery support tray in-line C1939 and connect 104-Pin Breakout Box (BOB) to traction battery support tray in-line C1939F and in-line C1939M using Traction Battery Low-Voltage Service Cord.</li> <li>• Turn the ignition key to the START position and measure the voltage between BOB pin 23 and ground (BOB pin 65).</li> <li>• <b>Is the voltage greater than 10 volts?</b></li> </ul>	<p>Yes = GO to <b>A9</b>.</p> <p>No = GO to <b>A7</b>.</p>
<p><b>A7 CHECK CIRCUIT 3986 (DG) BETWEEN TIM AND TRACTION BATTERY SUPPORT TRAY FOR OPEN</b></p> <ul style="list-style-type: none"> <li>• With key OFF, disconnect TIM C4998 and measure the resistance of the DG wire between pin 8 on TIM C4998 and BOB pin 23.</li> <li>• <b>Is the resistance less than 5 ohms?</b></li> </ul>	<p>Yes = GO to <b>A8</b>.</p> <p>No = REPAIR the DG wire.</p>
<p><b>A8 CHECK CIRCUIT 3986 (DG) BETWEEN TIM AND TRACTION BATTERY SUPPORT TRAY FOR SHORT TO GROUND</b></p> <ul style="list-style-type: none"> <li>• With key OFF, measure the resistance between BOB pin 23 and ground (BOB pin 65).</li> <li>• <b>Is the resistance greater than 10,000 ohms?</b></li> </ul>	<p>Yes = REPLACE the TIM. REFER to Section 303-14.</p> <p>No = REPAIR the DG wire.</p>
<p><b>A9 CHECK CIRCUIT 3986 (DG) BETWEEN CONTACTOR BOX AND TRACTION BATTERY SUPPORT TRAY FOR OPEN</b></p> <ul style="list-style-type: none"> <li>• With key OFF, disconnect the BOB from traction battery support tray in-line C1939F and in-line C1939M and remove the traction battery.</li> </ul> <p><b>⚠ WARNING: The traction battery contains high-voltage components and wiring. High-voltage insulated safety gloves and face shield must be worn when carrying out the following steps. Failure to follow this warning may result in severe personal injury or death.</b></p> <ul style="list-style-type: none"> <li>• Reconnect BOB to traction battery support tray in-line C1939F using Traction Battery Low-Voltage Service Cord; do not connect Traction Battery Low-Voltage Service Cord to in-line C1939M.</li> <li>• With key OFF, disconnect contactor box C1982 and measure the resistance of the DG wire between pin 11 on contactor box C1982 and BOB pin 23.</li> <li>• <b>Is the resistance less than 5 ohms?</b></li> </ul>	<p>Yes = GO to <b>A10</b>.</p> <p>No = REPAIR the DG wire.</p>
<p><b>A10 CHECK CIRCUIT 3986 (DG) BETWEEN CONTACTOR BOX AND TRACTION BATTERY SUPPORT TRAY FOR SHORT TO GROUND</b></p> <ul style="list-style-type: none"> <li>• With key OFF, measure the resistance between BOB pin 23 and ground (BOB pin 65).</li> <li>• <b>Is the resistance greater than 10,000 ohms?</b></li> </ul>	<p>Yes = GO to <b>A11</b>.</p> <p>No = REPAIR the DG wire.</p>
<p><b>A11 CHECK TRACTION BATTERY HIGH-VOLTAGE FUSE</b></p>	

(Continued)



**DIAGNOSIS AND TESTING (Continued)****PINPOINT TEST A: DTC B1676 BATTERY PACK VOLTAGE OUT OF RANGE**

TEST STEP	ACTION TO TAKE
<ul style="list-style-type: none"> <li>Measure the resistance between the terminals of the 250A traction battery high-voltage fuse.</li> <li><b>Is the resistance less than 5 ohms?</b></li> </ul>	Yes = REPLACE the contactor box. No = REPLACE the fuse.
<b>A12 CHECK TRACTION BATTERY VOLTAGE</b> <ul style="list-style-type: none"> <li>With key ON, monitor BCM PID BAT__PV and TIM PID BAT__PV.</li> <li>Turn the ignition key to the START position.</li> <li><b>Is there more than a 30-volt difference between the BAT__PV PIDs?</b></li> </ul>	Yes = REPLACE the TIM. REFER to Section 303-14. No = System OK. CHECK wiring for intermittent connections.

**PINPOINT TEST B: DTC C1862 CONTACTOR CIRCUIT FAILURE**

TEST STEP	ACTION TO TAKE
<b>B1 CHECK FOR INTERFACE ADAPTER ASSEMBLY (IAA) MODULE DIAGNOSTIC TROUBLE CODES (DTCs)</b> <p><b>NOTE:</b> Using High-Voltage Insulated Safety Gloves and Face Shield, disconnect and check the traction battery high-voltage two-pin C3994 for damage before carrying out the following test steps. Repair as necessary. If OK, reconnect and verify the connection is secure.</p> <ul style="list-style-type: none"> <li>Carry out the on-demand self-test for the IAA module.</li> <li><b>Do IAA module DTCs C1862 Contactor Circuit Failure and U2015 Signal Link Fault (Non SCP) occur?</b></li> </ul>	Yes = GO to Pinpoint Test A. No = GO to B2.
<b>B2 CHECK FOR TRACTION INVERTER MODULE (TIM) PRECHARGE FAULT</b> <ul style="list-style-type: none"> <li>With key ON, monitor TIM PID PRECH__F.</li> <li><b>Does the PRECH__F PID indicate YES?</b></li> </ul>	Yes = GO to B3. No = GO to B11.
<b>B3 CHECK STATUS OF TIM PRECHARGE BUS VOLTAGE</b> <ul style="list-style-type: none"> <li>With key ON, monitor TIM PID BAT__PV.</li> <li><b>Does the BAT__PV PID indicate less than 50 volts?</b></li> </ul>	Yes = GO to B4. No = GO to B10.
<b>B4 CHECK PRECHARGE CONTACTOR RELAY</b> <ul style="list-style-type: none"> <li>Enter the TIM active command mode CONTACTOR OUTPUT CONTROL, monitor the TIM PID BAT__PV, and set the active command PRECHG IN to CLOSE.</li> <li><b>Does the BAT__PV PID indicate less than 50 volts?</b></li> </ul>	Yes = GO to B5. No = GO to B10.
<b>B5 CHECK TIM PRECHARGE CONTACTOR CONTROL SIGNAL TO TRACTION BATTERY SUPPORT TRAY</b> <ul style="list-style-type: none"> <li>With key OFF, disconnect traction battery support tray in-line C1939 and connect 104-Pin Breakout Box (BOB) to traction battery support tray in-line C1939F and in-line C1939M using Traction Battery Low-Voltage Service Cord.</li> <li>With key ON, measure the voltage between BOB pin 22 and ground (BOB pin 65).</li> <li><b>Is the voltage greater than 10 volts?</b></li> </ul>	Yes = GO to B8. No = GO to B6.
<b>B6 CHECK CIRCUIT 3991 (T) BETWEEN TIM AND TRACTION BATTERY SUPPORT TRAY FOR OPEN</b> <ul style="list-style-type: none"> <li>With key OFF, disconnect TIM C4998 and measure the resistance of the T wire between pin 18 on TIM C4998 and BOB pin 22.</li> <li><b>Is the resistance less than 5 ohms?</b></li> </ul>	Yes = GO to B7. No = REPAIR the T wire.
<b>B7 CHECK CIRCUIT 3991 (T) BETWEEN TIM AND TRACTION BATTERY SUPPORT TRAY FOR SHORT TO GROUND</b> <ul style="list-style-type: none"> <li>With key OFF, measure the resistance between BOB pin 22 and ground (BOB pin 65).</li> </ul>	Yes = REPLACE the TIM. REFER to Section 303-14.

(Continued)

**DIAGNOSIS AND TESTING (Continued)****PINPOINT TEST B: DTC C1862 CONTACTOR CIRCUIT FAILURE**

TEST STEP	ACTION TO TAKE
<ul style="list-style-type: none"> <li>• Is the resistance greater than 10,000 ohms?</li> </ul>	No = REPAIR the T wire.
<p><b>B8 CHECK CIRCUIT 3991 (T) BETWEEN CONTACTOR BOX AND TRACTION BATTERY SUPPORT TRAY FOR OPEN</b></p> <ul style="list-style-type: none"> <li>• With key OFF, disconnect the BOB from traction battery support tray in-line C1939F and in-line C1939M and remove the traction battery.</li> </ul> <p><b>⚠ WARNING: The traction battery contains high-voltage components and wiring. High-voltage insulated safety gloves and face shield must be worn when carrying out the following steps. Failure to follow this warning may result in severe personal injury or death.</b></p> <ul style="list-style-type: none"> <li>• Reconnect BOB to traction battery support tray in-line C1939F using Traction Battery Low-Voltage Service Cord; do not connect Traction Battery Low-Voltage Service Cord to in-line C1939M.</li> <li>• With key OFF, disconnect contactor box C1982 and measure the resistance of the T wire between pin 18 on contactor box C1982 and BOB pin 22.</li> <li>• Is the resistance less than 5 ohms?</li> </ul>	<p>Yes = GO to <b>B9</b>.</p> <p>No = REPAIR the T wire.</p>
<p><b>B9 CHECK CIRCUIT 3991 (T) BETWEEN CONTACTOR BOX AND TRACTION BATTERY SUPPORT TRAY FOR SHORT TO GROUND</b></p> <ul style="list-style-type: none"> <li>• With key OFF, measure the resistance between BOB pin 22 and ground (BOB pin 65).</li> <li>• Is the resistance greater than 10,000 ohms?</li> </ul>	<p>Yes = REPLACE the contactor box.</p> <p>No = REPAIR the T wire.</p>
<p><b>B10 CHECK TRACTION BATTERY VOLTAGE</b></p> <ul style="list-style-type: none"> <li>• With key ON, monitor BCM PID BAT__PV and TIM PID BAT__PV.</li> <li>• Is there more than a 30-volt difference between the BAT__PV PIDs?</li> </ul>	<p>Yes = REPLACE the TIM. REFER to Section 303-14.</p> <p>No = System OK. CHECK wiring for intermittent connections.</p>
<p><b>B11 CHECK FOR WELDED MAIN CONTACTOR RELAY</b></p> <ul style="list-style-type: none"> <li>• Enter TIM active command mode CONTACTOR OUTPUT CONTROL and monitor TIM PID BAT__PV.</li> <li>• Does the voltage for the BAT__PV PID decrease?</li> </ul>	<p>Yes = System OK. CHECK wiring for intermittent connections.</p> <p>No = GO to <b>B12</b>.</p>
<p><b>B12 CHECK MAIN AND PRECHARGE CONTACTOR RELAY OUTPUTS</b></p> <ul style="list-style-type: none"> <li>• Connect 104-Pin Breakout Box (BOB) to TIM and TIM C4998, C4999 using the BCM/TIM BOB Adapter Cable and Overlay.</li> <li>• Enter traction inverter module (TIM) active command mode CONTACTOR OUTPUT CONTROL.</li> <li>• With key ON, measure the voltage between BOB pins A8, A18 and ground (BOB pin A29).</li> <li>• Is either voltage greater than 10 volts?</li> </ul>	<p>Yes = GO to <b>B13</b>.</p> <p>No = REPLACE the contactor box.</p>
<p><b>B13 CHECK CIRCUITS 3991 (T) AND 3986 (DG) FOR SHORT(S) TO POWER</b></p> <ul style="list-style-type: none"> <li>• With key OFF, disconnect the TIM from the BOB; leave BOB connected to TIM C4998, C4999.</li> <li>• With key ON, measure the voltage between BOB pins A8, A18 and ground (BOB pin A29).</li> <li>• Is either voltage greater than 1 volt?</li> </ul>	<p>Yes = REPAIR the wire(s) in question.</p> <p>No = REPLACE the TIM. REFER to Section 303-14.</p>

**DIAGNOSIS AND TESTING (Continued)**

**Negative Contactor Relay Control**

**Diagnostic Trouble Code (DTC) Definition**

The following DTC relates to the negative contactor relay in the contactor box:

- DTC C1862 Contactor Circuit Failure
  - The BCM sets DTC C1862 before entering current mode, voltage mode, and during voltage mode each time before charging if there is current flow through the contactor box auxiliary current sensor while the BCM asserts the negative bus open signal and enables the charger with 72% duty cycle in current mode. This indicates the negative contactor relay is stuck closed. The BCM also sets DTC C1862 if the traction inverter module (TIM) detects a welded main contactor relay and sends the BCM a disable charging message.

**Electrical Schematic**

Refer to Electrical and Vacuum Troubleshooting Manual, Cell 21, Contactor Box Relay Control for schematic and connector information.

**Inspection and Verification**

Refer to [Section 100-07](#).

**Symptom Chart**

**Symptom Chart**

Condition	Possible Sources	Action
<ul style="list-style-type: none"> <li>• DTC C1862 Contactor Circuit Failure</li> </ul>	<ul style="list-style-type: none"> <li>• Circuit.</li> <li>• Contactor box.</li> <li>• Battery control module (BCM).</li> </ul>	<ul style="list-style-type: none"> <li>• GO to Pinpoint Test A.</li> </ul>

**Pinpoint Tests**

**Special Tool(s)**

104-Pin Breakout Box (BOB) 418-049 (014-00950) or equivalent
BCM/TIM Breakout Box (BOB) Adapter Cable 418-F212
BCM/TIM Breakout Box (BOB) Overlay 418-F220

(Continued)

**Special Tool(s)**

Traction Battery High-Voltage Service Cord 418-F218
Traction Battery Low-Voltage Service Cord 418-F219
Traction Battery High-Voltage Lockout and Diagnostic Tool 418-F207
High-Voltage Insulated Safety Gloves 100-F036 or equivalent
Face Shield 100-F035 or equivalent

**PINPOINT TEST A: DTC C1862 CONTACTOR CIRCUIT FAILURE**

TEST STEP	ACTION TO TAKE
<p><b>A1 CHECK STATUS OF BATTERY CONTROL MODULE (BCM) OPERATING STATE</b></p> <ul style="list-style-type: none"> <li>• Connect the vehicle to the power control station (PCS) and press the START button (if necessary) to begin charging.</li> <li>• With key OFF, monitor BCM PID BCM__OP.</li> </ul> <p>• Does the BCM__OP PID indicate 106 (negative contactor relay welded/stuck closed) or 107 (no charge-TIM SCP message: main contactor relay welded/stuck closed)?</p>	<p>Yes = If 106, GO to A2.</p> <p>If 107, GO to Pinpoint Test B in Main/Precharge Contactor Relay Control.</p> <p>No = System OK.</p>

(Continued)

**DIAGNOSIS AND TESTING (Continued)****PINPOINT TEST A: DTC C1862 CONTACTOR CIRCUIT FAILURE**

TEST STEP	ACTION TO TAKE
<b>A2 CHECK FOR WELDED MAIN CONTACTOR RELAY</b> <ul style="list-style-type: none"> <li>• Press the STOP button on the PCS and disconnect the PCS from the charger inlet.</li> <li>• Enter traction inverter module (TIM) active command mode CONTACTOR OUTPUT CONTROL and monitor TIM PID BAT__PV.</li> <li>• <b>Does the voltage for the BAT__PV PID decrease?</b></li> </ul>	Yes = GO to <b>A3</b> .  No = REPLACE the contactor box.
<b>A3 CHECK (MANUALLY) FOR WELDED CONTACTOR RELAY(S)</b> <p><b>NOTE:</b> Do not connect the Traction Battery High-Voltage Lockout and Diagnostic Tool or any of the traction battery service cords until indicated to do so.</p> <ul style="list-style-type: none"> <li>• Remove the traction battery.</li> </ul> <p> <b>WARNING: The traction battery contains high-voltage components and wiring. High-voltage insulated safety gloves and face shield must be worn when carrying out the following steps. Failure to follow this warning may result in severe personal injury or death.</b></p> <ul style="list-style-type: none"> <li>• <b>NOTE:</b> The high-voltage input to the contactor box is on the passenger side of the contactor box. The high-voltage negative input to the contactor box is the post towards the front of the vehicle and the high-voltage positive input is the post towards the rear of the vehicle. The high-voltage negative output pin for the traction battery two-pin connector (C3994) is the pin towards the front of the vehicle and the high-voltage positive output pin is the pin towards the rear of the vehicle. Measure the voltage between the high-voltage positive post on the contactor box and the high-voltage negative pin on the traction battery two-pin connector.</li> <li>• Measure the voltage between the high-voltage negative post on the contactor box and the high-voltage positive pin on the traction battery two-pin connector.</li> <li>• <b>Are any of the voltages greater than 200 volts?</b></li> </ul>	Yes = REPLACE the contactor box.  No = GO to <b>A4</b> .
<b>A4 CHECK NEGATIVE CONTACTOR RELAY CONTROL (OPEN SIGNAL)</b> <ul style="list-style-type: none"> <li>• Connect Traction Battery High-Voltage Lockout and Diagnostic Tool to the traction battery high-voltage two-pin C3994M.</li> <li>• Connect Traction Battery High-Voltage Service Cord to traction battery support tray in-line C1935F and in-line C1935M.</li> <li>• Connect Traction Battery Low-Voltage Service Cord to traction battery support tray in-line C1939F and in-line C1939M.</li> <li>• Connect 104-Pin Breakout Box (BOB) to battery control module (BCM) and BCM C1986, C1987 using BCM/TIM BOB Adapter Cable and Overlay.</li> <li>• Enter BCM active command mode CONTACTOR OUTPUT CONTROL, set the active command NEG MAIN to OPEN, and measure the voltage between BOB pin B7 and ground (BOB pin A33).</li> <li>• <b>Is the voltage greater than 10 volts?</b></li> </ul>	Yes = GO to <b>A6</b> .  No = GO to <b>A5</b> .
<b>A5 CHECK CIRCUIT 3136 (W) FOR SHORT TO GROUND</b> <ul style="list-style-type: none"> <li>• With key OFF, disconnect BOB from BCM; leave BOB connected to BCM C1986 and C1987.</li> <li>• With key OFF, disconnect contactor box C1982 and measure the resistance between BOB pin B7 and ground (BOB pin A33).</li> <li>• <b>Is the resistance greater than 10,000 ohms?</b></li> </ul>	Yes = REPLACE the BCM.  No = REPAIR the W wire.

(Continued)

**DIAGNOSIS AND TESTING (Continued)****PINPOINT TEST A: DTC C1862 CONTACTOR CIRCUIT FAILURE**

TEST STEP	ACTION TO TAKE
<b>A6 CHECK CIRCUIT 3136 (W) FOR OPEN</b> <ul style="list-style-type: none"> <li>With key OFF, disconnect contactor box C1982 and measure the resistance of the W wire between pin 3 on contactor box C1982 and BOB pin B7.</li> <li>Is the resistance less than 5 ohms?</li> </ul>	Yes = REPLACE the contactor box.  No = REPAIR the W wire.

**Emergency Power Off (EPO)/Interlock System****Diagnostic Trouble Code (DTC) Definition**

The following DTC relates to the Emergency Power Off (EPO)/Interlock System:

- DTC B2517 Emergency Power Off System Faulted

— An emergency power off (EPO) occurs when the contactor box outputs an EPO signal through the EPO circuit to the battery control module (BCM), interface adapter assembly (IAA) module and positive temperature coefficient (PTC) switching module. If an EPO condition occurs, the contactor box disables the high-voltage system and the IAA module sets DTC B2517. An open high-voltage connector interlock, an EPO request from the BCM and an activated inertia switch will cause an EPO condition. The IAA module will not set DTC B2517 if the inertia switch is activated. If the inertia switch is activated, the power reset indicator will illuminate.

**Electrical Schematic**

Refer to Electrical and Vacuum Troubleshooting Manual, Cell 20, Emergency Power Off (EPO)/Interlock System for schematic and connector information.

**Inspection and Verification**

Refer to [Section 100-07](#).

**Symptom Chart****Symptom Chart**

Condition	Possible Sources	Action
<ul style="list-style-type: none"> <li>DTC B2517 Emergency Power Off System Faulted</li> </ul>	<ul style="list-style-type: none"> <li>Fuse.</li> <li>Interface adapter assembly (IAA) module.</li> <li>Circuit(s).</li> <li>Inertia switch.</li> <li>High-voltage power distribution box (HVPDB).</li> <li>Power steering assembly.</li> <li>Contactor box.</li> <li>High-voltage harness (14B322).</li> </ul>	<ul style="list-style-type: none"> <li>GO to Pinpoint Test A.</li> </ul>
<ul style="list-style-type: none"> <li>Vehicle Will Not Start (Power Reset Indicator Illuminated)</li> </ul>	<ul style="list-style-type: none"> <li>Inertia switch.</li> <li>Interface adapter assembly (IAA) module.</li> </ul>	<ul style="list-style-type: none"> <li>GO to Pinpoint Test B.</li> </ul>

**DIAGNOSIS AND TESTING (Continued)****Pinpoint Tests****Special Tool(s)**

104-Pin Breakout Box (BOB) 418-049 (014-00950) or equivalent
BCM/TIM Breakout Box (BOB) Adapter Cable 418-F212

(Continued)

**Special Tool(s)**

BCM/TIM Breakout Box (BOB) Overlay 418-F220
Traction Battery High-Voltage Service Cord 418-F218
Traction Battery Low-Voltage Service Cord 418-F219
Traction Battery High-Voltage Lockout and Diagnostic Tool 418-F207

**PINPOINT TEST A: DTC B2517 EMERGENCY POWER OFF SYSTEM FAULTED**

TEST STEP	ACTION TO TAKE
<b>A1 CHECK FUSE</b> <ul style="list-style-type: none"> <li>Check 15A fuse 7 in the electric vehicle power distribution box (EVPDB).</li> <li><b>Is the fuse OK?</b></li> </ul>	Yes = GO to <b>A2</b> .  No = REPLACE the fuse. If fuse fails again, CHECK/REPAIR for a short to ground.
<b>A2 CHECK BATTERY CONTROL MODULE (BCM) EMERGENCY POWER OFF (EPO) STATUS</b> <ul style="list-style-type: none"> <li>With key ON, monitor BCM PID EMG__PO.</li> <li><b>Does the EMG__PO PID indicate ENABLE?</b></li> </ul>	Yes = GO to <b>A5</b> . No = GO to <b>A3</b> .
<b>A3 CHECK EPO DISABLE SIGNAL TO IAA MODULE</b> <ul style="list-style-type: none"> <li>Connect 104-Pin Breakout Box (BOB) to IAA module C1945; leave IAA module disconnected.</li> <li>With key ON, measure the voltage between BOB pin 91 and ground (BOB pin 80).</li> <li><b>Is the voltage greater than 10 volts?</b></li> </ul>	Yes = REPLACE the IAA module. REFER to Section 412-04. No = GO to <b>A4</b> .
<b>A4 CHECK EPO DISABLE SIGNAL TO TRACTION BATTERY SUPPORT TRAY</b> <ul style="list-style-type: none"> <li>Disconnect BOB and reconnect IAA module C1945.</li> <li>With key OFF, disconnect traction battery support tray in-line C1939 and connect BOB to traction battery support tray in-line C1939F and in-line C1939M using Traction Battery Low-Voltage Service Cord.</li> <li>With key ON, measure the voltage between BOB pin 19 and ground (BOB pin 65).</li> <li><b>Is the voltage greater than 10 volts?</b></li> </ul>	Yes = REPAIR circuit 3006 (P/LG wire) between the IAA module and in-line C1939M. No = REMOVE the traction battery and REPAIR circuit 3006 (P/LG wire) between the contactor box and traction battery support tray in-line C1939F.
<b>A5 CHECK TRACTION INVERTER MODULE (TIM) EMERGENCY POWER OFF (EPO) STATUS</b> <ul style="list-style-type: none"> <li>With key ON, monitor TIM PID EMG__PO.</li> <li><b>Does the EMG__PO PID indicate ENABLE?</b></li> </ul>	Yes = GO to <b>A13</b> . No = GO to <b>A6</b> .
<b>A6 CHECK POWER TO IN-LINE C1948</b> <ul style="list-style-type: none"> <li>With key OFF, disconnect two-pin in-line C1948 (located behind the high voltage power distribution box [HVPDB]) and measure the voltage between the O wire on in-line C1948F and ground.</li> <li><b>Is the voltage greater than 10 volts?</b></li> </ul>	Yes = RECONNECT in-line C1948. GO to <b>A9</b> .  No = GO to <b>A7</b> .
<b>A7 CHECK POWER TO INERTIA SWITCH</b> <ul style="list-style-type: none"> <li>With key OFF, disconnect inertia switch C249 and measure the voltage between the LB/W wire on inertia switch C249 and ground.</li> <li><b>Is the voltage greater than 10 volts?</b></li> </ul>	Yes = GO to <b>A8</b> .  No = REPAIR the LB/W wire.
<b>A8 CHECK INERTIA SWITCH</b>	

(Continued)

**DIAGNOSIS AND TESTING (Continued)****PINPOINT TEST A: DTC B2517 EMERGENCY POWER OFF SYSTEM FAULTED**

TEST STEP	ACTION TO TAKE
<ul style="list-style-type: none"> <li>Measure the resistance between the LB/W wire terminal and O wire terminal on the inertia switch with the inertia switch in the deactivated (depressed) position.</li> <li><b>Is the resistance less than 5 ohms?</b></li> </ul>	Yes = REPAIR the O wire between the inertia switch and in-line C1948F. No = REPLACE the inertia switch.
<b>A9 CHECK POWER TO TRACTION BATTERY SUPPORT TRAY</b> <ul style="list-style-type: none"> <li>With key OFF, disconnect high-voltage auxiliary load in-line C1935 on the traction battery support tray and measure the voltage between the R wire on in-line C1935M and ground.</li> <li><b>Is the voltage greater than 10 volts?</b></li> </ul>	Yes = GO to A12. No = GO to A10.
<b>A10 CHECK POWER TO POWER STEERING ASSEMBLY</b> <ul style="list-style-type: none"> <li>With key OFF, disconnect power steering assembly high-voltage C1895 and measure the voltage between the DG wire on power steering assembly C1895 and ground.</li> <li><b>Is the voltage greater than 10 volts?</b></li> </ul>	Yes = GO to A11. No = REPLACE the HVPDB.
<b>A11 CHECK POWER STEERING ASSEMBLY INTERLOCK JUMPER</b> <ul style="list-style-type: none"> <li>With key OFF, measure the resistance between the DG wire terminal and R wire terminal on the power steering assembly.</li> <li><b>Is the resistance less than 5 ohms?</b></li> </ul>	Yes = REPLACE the HVPDB. No = REPLACE the power steering assembly.
<b>A12 CHECK POWER TO CONTACTOR BOX</b> <ul style="list-style-type: none"> <li>Remove the traction battery and connect Traction Battery High-Voltage Lockout and Diagnostic Tool to the traction battery high-voltage two-pin C3994M.</li> <li>Connect Traction Battery High-Voltage Service Cord to high-voltage auxiliary load in-line C1935F on the traction battery support tray and in-line C1935M.</li> </ul> <p><b>⚠ WARNING: The traction battery contains high-voltage components and wiring. High-voltage insulated safety gloves and face shield must be worn when carrying out the following steps. Failure to follow this warning may result in severe personal injury or death.</b></p> <ul style="list-style-type: none"> <li><b>NOTE:</b> Contactor box C3985 is mounted on the passenger side of the BCM. With key OFF, disconnect contactor box C3985 and measure the voltage between the R wire on contactor box C3985 and ground.</li> <li><b>Is the voltage greater than 10 volts?</b></li> </ul>	Yes = REPLACE the contactor box. No = REPAIR the R wire between the contactor box and in-line C1935F.
<b>A13 CHECK POWER TO TRACTION INVERTER MODULE (TIM) TWO-PIN HIGH-VOLTAGE CONNECTOR</b> <ul style="list-style-type: none"> <li>With key OFF, disconnect traction battery high-voltage two-pin C3994.</li> <li>With key OFF, measure the voltage between both interlock pins on the traction battery support tray C3994M and ground.</li> <li><b>Is the voltage greater than 10 volts on one of the interlock pins?</b></li> </ul>	Yes = GO to A15. No = GO to A14.
<b>A14 CHECK POWER TO TRACTION BATTERY SUPPORT TRAY</b> <ul style="list-style-type: none"> <li>With key OFF, disconnect traction battery support tray in-line C1939 and connect BOB to traction battery support tray in-line C1939F and in-line C1939M using Traction Battery Low-Voltage Service Cord.</li> </ul>	Yes = REMOVE the traction battery and REPAIR circuit 974 (O wire) between traction battery support tray in-line C1939F and traction battery support tray C3994M.

(Continued)

**DIAGNOSIS AND TESTING (Continued)****PINPOINT TEST A: DTC B2517 EMERGENCY POWER OFF SYSTEM FAULTED**

TEST STEP	ACTION TO TAKE
<ul style="list-style-type: none"> <li>With key OFF, measure the voltage between BOB pin 47 and ground (BOB pin 65).</li> <li><b>Is the voltage greater than 10 volts?</b></li> </ul>	No = REPAIR circuit 974 (O wire) between in-line C1939M and S1963.
<b>A15 CHECK TIM HIGH-VOLTAGE TWO-PIN CONNECTOR INTERLOCK FOR OPEN</b> <ul style="list-style-type: none"> <li>With key OFF, measure the resistance between the interlock pins on TIM high-voltage two-pin C3994F.</li> <li><b>Is the resistance less than 5 ohms?</b></li> </ul>	Yes = GO to <b>A16</b> .  No = REPLACE the high-voltage harness (14B322) between the TIM and traction battery support tray.
<b>A16 CHECK POWER TO CONTACTOR BOX</b> <ul style="list-style-type: none"> <li>Remove the traction battery and connect Traction Battery High-Voltage Lockout and Diagnostic Tool to the traction battery high-voltage two-pin C3994M.</li> <li>Connect Traction Battery High-Voltage Service Cord to traction battery support tray in-line C1935F and in-line C1935M.</li> </ul> <p> <b>WARNING: The traction battery contains high-voltage components and wiring. High-voltage insulated safety gloves and face shield must be worn when carrying out the following steps. Failure to follow this warning may result in severe personal injury or death.</b></p> <ul style="list-style-type: none"> <li>Connect Traction Battery Low-Voltage Service Cord to traction battery support tray in-line C1939F and in-line C1939M.</li> <li>With key OFF, disconnect contactor box C1982 and measure the voltage between pin 6 (Y wire) on contactor box C1982 and ground.</li> <li><b>Is the voltage greater than 10 volts?</b></li> </ul>	Yes = REPLACE the contactor box.  No = REPAIR the Y wire between the contactor box and traction battery support tray C3994M.

**PINPOINT TEST B: VEHICLE WILL NOT START (POWER RESET INDICATOR ILLUMINATED)**

TEST STEP	ACTION TO TAKE
<b>B1 CHECK FOR ACTIVATED INERTIA SWITCH</b> <ul style="list-style-type: none"> <li>Check the inertia switch.</li> <li><b>Is the inertia switch activated?</b></li> </ul>	Yes = RESET the inertia switch. No = GO to <b>B2</b> .
<b>B2 CHECK INERTIA SWITCH</b> <ul style="list-style-type: none"> <li>With key OFF, disconnect inertia switch C249 and measure the resistance between the LB/W wire terminal and W wire terminal on the inertia switch with the inertia switch in the deactivated (depressed) position.</li> <li><b>Is the resistance less than 5 ohms?</b></li> </ul>	Yes = REPLACE the inertia switch.  No = REPLACE the interface adapter assembly (IAA) module.



**DIAGNOSIS AND TESTING (Continued)**

**Contactor Box Current Sensors**

**Diagnostic Trouble Code (DTC) Definition**

The following DTC relates to the main and auxiliary current sensors in the contactor box:

- DTC C1835 Current Sense Circuit Failure
  - The battery control module (BCM) uses the main current sensor to monitor the current flowing through the main high-voltage bus during the drive cycle and the auxiliary current sensor to monitor the current flowing through the auxiliary high-voltage bus during the charge and drive cycles. The BCM sets DTC C1835 if the main or auxiliary current sensors fall out of range at any time. Out of range is considered to be below 5 milliamps or above 45 milliamps. The BCM also sets DTC C1835 for the main current sensor if the current estimate from the traction inverter module (TIM) is 50 amps greater than the current reading from the main current sensor.

**Electrical Schematic**

Refer to Electrical and Vacuum Troubleshooting Manual, Cell 16, Traction Battery System for schematic and connector information.

**Inspection and Verification**

Refer to [Section 100-07](#).

**Symptom Chart**

**Symptom Chart**

Condition	Possible Sources	Action
<ul style="list-style-type: none"> <li>• DTC C1835 Current Sense Circuit Failure</li> </ul>	<ul style="list-style-type: none"> <li>• Circuit(s).</li> <li>• Contactor box.</li> <li>• Battery control module (BCM).</li> </ul>	<ul style="list-style-type: none"> <li>• GO to Pinpoint Test A.</li> </ul>

**Pinpoint Tests**

**Special Tool(s)**

104-Pin Breakout Box (BOB) 418-049 (014-00950) or equivalent
BCM/TIM Breakout Box (BOB) Adapter Cable 418-F212
BCM/TIM Breakout Box (BOB) Overlay 418-F220

(Continued)

**Special Tool(s)**

Traction Battery High-Voltage Service Cord 418-F218
Traction Battery Low-Voltage Service Cord 418-F219
Traction Battery High-Voltage Lockout and Diagnostic Tool 418-F207
High-Voltage Insulated Safety Gloves 100-F036 or equivalent
Face Shield 100-F035 or equivalent

**PINPOINT TEST A: DTC C1835 CURRENT SENSE CIRCUIT FAILURE**

TEST STEP	ACTION TO TAKE
<b>A1 CHECK STATUS OF CONTACTOR BOX AUXILIARY CURRENT SENSOR</b> <ul style="list-style-type: none"> <li>• With key ON, monitor battery control module (BCM) PID AUX__SEN.</li> <li>• <b>Does the AUX__SEN PID indicate between 0.5 and 4.5 volts?</b></li> </ul>	Yes = GO to <b>A2</b> . No = GO to <b>A4</b> .
<b>A2 CHECK STATUS OF CONTACTOR BOX MAIN CURRENT SENSOR</b> <ul style="list-style-type: none"> <li>• With key ON, monitor BCM PID MAINSEN.</li> </ul>	Yes = GO to <b>A3</b> .



(Continued)

**DIAGNOSIS AND TESTING (Continued)****PINPOINT TEST A: DTC C1835 CURRENT SENSE CIRCUIT FAILURE**

TEST STEP	ACTION TO TAKE
<ul style="list-style-type: none"> <li>• Does the MAINSEN PID indicate between 0.5 and 4.5 volts?</li> </ul>	No = GO to A8.
<b>A3 CHECK STATUS OF CONTACTOR BOX MAIN CURRENT SENSOR WHILE DRIVING</b>	
<ul style="list-style-type: none"> <li>• Lift the vehicle on a hoist. Refer to Section 100-02.</li> <li>• Start the vehicle, move the transmission range selector lever to the Drive (D) position, and depress/release the accelerator pedal two or three times while monitoring BCM PID MAINSEN.</li> </ul>	Yes = GO to A12.
<ul style="list-style-type: none"> <li>• Does the MAINSEN PID voltage increase upon acceleration?</li> </ul>	No = REPLACE the contactor box.
<b>A4 CHECK AUXILIARY CURRENT SENSOR SIGNAL TO BCM</b>	
<ul style="list-style-type: none"> <li>• Remove the traction battery and connect Traction Battery High-Voltage Lockout and Diagnostic Tool to the traction battery high-voltage two-pin C3994M.</li> </ul>	Yes = REPLACE the BCM.
<p> <b>WARNING: The traction battery contains high-voltage components and wiring. High-voltage insulated safety gloves and face shield must be worn when carrying out the following steps. Failure to follow this warning may result in severe personal injury or death.</b></p>	
<ul style="list-style-type: none"> <li>• Connect Traction Battery High-Voltage Service Cord to traction battery support tray in-line C1935F and in-line C1935M.</li> <li>• Connect Traction Battery Low-Voltage Service Cord to traction battery support tray in-line C1939F and in-line C1939M.</li> <li>• Connect 104-Pin Breakout Box (BOB) to BCM C1986, C1987 using the BCM/TIM BOB Adapter Cable and Overlay; leave the BCM disconnected.</li> <li>• With key ON, measure the voltage between BOB pin A17 and ground (BOB pin A33).</li> <li>• Is the voltage between 5 and 8 volts?</li> </ul>	No = GO to A5.
<b>A5 CHECK CIRCUITS 3996 (R/Y) AND 3705 (LB) FOR OPEN(S)</b>	
<ul style="list-style-type: none"> <li>• With key OFF, disconnect contactor box C1982 and measure the resistance of the R/Y wire between pin 21 on contactor box C1982 and BOB pin A16.</li> <li>• With key OFF, measure the resistance of the LB wire between pin 22 on contactor box C1982 and BOB pin A17.</li> <li>• Are the resistances less than 5 ohms?</li> </ul>	Yes = GO to A6. No = REPAIR the wire(s) in question.
<b>A6 CHECK CIRCUIT 3705 (LB) FOR SHORT TO GROUND</b>	
<ul style="list-style-type: none"> <li>• With key OFF, measure the resistance between BOB pin A17 and ground (BOB pin A33).</li> <li>• Is the resistance greater than 10,000 ohms?</li> </ul>	Yes = GO to A7. No = REPAIR the LB wire.
<b>A7 CHECK CIRCUIT 3705 (LB) FOR SHORT TO POWER</b>	
<ul style="list-style-type: none"> <li>• With key ON, measure the voltage between BOB pin A17 and ground (BOB pin A33).</li> <li>• Is the voltage greater than 0 volts?</li> </ul>	Yes = REPAIR the LB wire. No = REPLACE the contactor box.
<b>A8 CHECK MAIN CURRENT SENSOR SIGNAL TO BCM</b>	
<ul style="list-style-type: none"> <li>• Remove the traction battery and connect Traction Battery High-Voltage Lockout and Diagnostic Tool to the traction battery high-voltage two-pin C3994M.</li> </ul>	Yes = REPLACE the BCM.

(Continued)

**DIAGNOSIS AND TESTING (Continued)****PINPOINT TEST A: DTC C1835 CURRENT SENSE CIRCUIT FAILURE**

TEST STEP	ACTION TO TAKE
<p> <b>WARNING: The traction battery contains high-voltage components and wiring. High-voltage insulated safety gloves and face shield must be worn when carrying out the following steps. Failure to follow this warning may result in severe personal injury or death.</b></p> <ul style="list-style-type: none"> <li>• Connect Traction Battery High-Voltage Service Cord to traction battery support tray in-line C1935F and in-line C1935M.</li> <li>• Connect Traction Battery Low-Voltage Service Cord to traction battery support tray in-line C1939F and in-line C1939M.</li> <li>• Connect 104-Pin Breakout Box (BOB) to BCM C1986, C1987 using the BCM/TIM BOB Adapter Cable and Overlay; leave the BCM disconnected.</li> <li>• With key ON, measure the voltage between BOB pin A15 and ground (BOB pin A33).</li> <li>• <b>Is the voltage between 5 and 8 volts?</b></li> </ul>	<p>No = GO to <b>A9</b>.</p>
<p><b>A9 CHECK CIRCUITS 3602 (T/Y) AND 3706 (DB) FOR OPEN(S)</b></p> <ul style="list-style-type: none"> <li>• With key OFF, disconnect contactor box C1982 and measure the resistance of the T/Y wire between pin 23 on contactor box C1982 and BOB pin B1.</li> <li>• With key OFF, measure the resistance of the DB wire between pin 15 on contactor box C1982 and BOB pin A15.</li> <li>• <b>Are the resistances less than 5 ohms?</b></li> </ul>	<p>Yes = GO to <b>A10</b>.</p> <p>No = REPAIR the wire(s) in question.</p>
<p><b>A10 CHECK CIRCUIT 3706 (DB) FOR SHORT TO GROUND</b></p> <ul style="list-style-type: none"> <li>• With key OFF, measure the resistance between BOB pin A15 and ground (BOB pin A33).</li> <li>• <b>Is the resistance greater than 10,000 ohms?</b></li> </ul>	<p>Yes = GO to <b>A11</b>.</p> <p>No = REPAIR the DB wire.</p>
<p><b>A11 CHECK CIRCUIT 3706 (DB) FOR SHORT TO POWER</b></p> <ul style="list-style-type: none"> <li>• With key ON, measure the voltage between BOB pin A15 and ground (BOB pin A33).</li> <li>• <b>Is the voltage greater than 0 volts?</b></li> </ul>	<p>Yes = REPAIR the DB wire.</p> <p>No = REPLACE the contactor box.</p>
<p><b>A12 CHECK CURRENT SENSE CONTROL DISABLE SIGNAL</b></p> <ul style="list-style-type: none"> <li>• Remove the traction battery and connect Traction Battery High-Voltage Lockout and Diagnostic Tool to the traction battery high-voltage two-pin C3994M.</li> </ul> <p> <b>WARNING: The traction battery contains high-voltage components and wiring. High-voltage insulated safety gloves and face shield must be worn when carrying out the following steps. Failure to follow this warning may result in severe personal injury or death.</b></p> <ul style="list-style-type: none"> <li>• Connect Traction Battery High-Voltage Service Cord to traction battery support tray in-line C1935F and in-line C1935M.</li> <li>• Connect Traction Battery Low-Voltage Service Cord to traction battery support tray in-line C1939F and in-line C1939M.</li> <li>• Connect 104-Pin Breakout Box (BOB) to BCM and BCM C1986, C1987 using the BCM/TIM BOB Adapter Cable and Overlay.</li> <li>• Enter BCM active command mode BCM PACKETED COMMANDS, set the active command CURRENT S to DISABLE, and measure the voltage between BOB pin B22 and ground (BOB pin A33).</li> <li>• <b>Is the voltage greater than 7.5 volts?</b></li> </ul>	<p>Yes = GO to <b>A13</b>.</p> <p>No = GO to <b>A15</b>.</p>
<p><b>A13 CHECK CURRENT SENSE CONTROL ENABLE SIGNAL</b></p> <ul style="list-style-type: none"> <li>• Set the active command CURRENT S to ENABLE and measure the voltage between BOB pin B22 and ground (BOB pin A33).</li> <li>• <b>Is the voltage less than 1 volt?</b></li> </ul>	<p>Yes = System OK. CHECK wiring for intermittent connections.</p> <p>No = GO to <b>A14</b>.</p>

(Continued)

**DIAGNOSIS AND TESTING (Continued)****PINPOINT TEST A: DTC C1835 CURRENT SENSE CIRCUIT FAILURE**

TEST STEP	ACTION TO TAKE
<b>A14 CHECK CIRCUIT 3138 (LB/BK) FOR SHORT TO POWER</b> <ul style="list-style-type: none"> <li>With key OFF, disconnect the BOB from the BCM; leave BOB connected to BCM C1986 and C1987.</li> <li>With key OFF, disconnect contactor box C1982.</li> <li>With key ON, measure the voltage between BOB pin B22 and ground (BOB pin A33).</li> <li><b>Is the voltage greater than 0 volts?</b></li> </ul>	Yes = REPAIR the LB/BK wire. No = REPLACE the BCM.
<b>A15 CHECK CONTACTOR BOX SIGNAL TO BCM</b> <ul style="list-style-type: none"> <li>With key OFF, disconnect the BOB from the BCM; leave BOB connected to BCM C1986 and C1987.</li> <li>With key ON, measure the voltage between BOB pin B22 and ground (BOB pin A33).</li> <li><b>Is the voltage between 7.5 and 9 volts?</b></li> </ul>	Yes = REPLACE the BCM. No = GO to <b>A16</b> .
<b>A16 CHECK CIRCUIT 3138 (LB/BK) FOR OPEN</b> <ul style="list-style-type: none"> <li>With key OFF, disconnect contactor box C1982 and measure the resistance of the LB/BK wire between pin 12 on contactor box C1982 and BOB pin B22.</li> <li><b>Is the resistance less than 5 ohms?</b></li> </ul>	Yes = GO to <b>A17</b> . No = REPAIR the LB/BK wire.
<b>A17 CHECK CIRCUIT 3138 (LB/BK) FOR SHORT TO GROUND</b> <ul style="list-style-type: none"> <li>With key OFF, measure the resistance between BOB pin B22 and ground (BOB pin A33).</li> <li><b>Is the resistance greater than 10,000 ohms?</b></li> </ul>	Yes = REPLACE the contactor box. No = REPAIR the LB/BK wire.

**Current Leakage Detection****Diagnostic Trouble Code (DTC) Definition**

The following DTC relates to current leakage detection:

- DTC C1839 Leakage Fault
  - Current leakage is a low level of impedance between vehicle chassis and either traction battery positive (TB+) or traction battery negative (TB-). The battery control module (BCM) checks for a parallel combination of bus leakage impedance (between vehicle chassis and TB+, and between vehicle chassis and TB-) during the charge and drive cycles. The BCM sets DTC C1839 when it detects a low level of leakage (between 10,000 and 50,000 ohms) during charging, high level leakage (less than 10,000 ohms) during charging, leakage (less than 50,000 ohms) during driving, or if the leakage circuit fails. The BCM uses PIDs to indicate when the leakage occurred, the severity of the leakage when it occurred, and the status of the leakage circuits.

**Electrical Schematic**

Refer to Electrical and Vacuum Troubleshooting Manual, Cell 16, Traction Battery System for schematic and connector information.

**Inspection and Verification**

Refer to [Section 100-07](#).

**DIAGNOSIS AND TESTING (Continued)**

**Symptom Chart**

**Symptom Chart**

Condition	Possible Sources	Action
<ul style="list-style-type: none"> <li>DTC C1839 Leakage Fault</li> </ul>	<ul style="list-style-type: none"> <li>High-voltage harness (10B694).</li> <li>High-voltage harness(es) (14A280).</li> <li>Battery control module (BCM).</li> <li>A/C inverter motor controller (IMC).</li> <li>A/C compressor.</li> <li>Traction inverter module (TIM).</li> <li>Motor/transaxle.</li> <li>High-voltage harness (10B700).</li> <li>Contactors box.</li> <li>Power steering assembly.</li> <li>Positive temperature coefficient (PTC) heater.</li> <li>PTC switching module.</li> <li>DC/DC converter.</li> <li>High-voltage power distribution box (HVPDB).</li> <li>Traction battery charger.</li> <li>High-voltage harness (14B322).</li> </ul>	<ul style="list-style-type: none"> <li>GO to Pinpoint Test A.</li> </ul>

**Pinpoint Tests**

**Special Tool(s)**

104-Pin Breakout Box (BOB) 418-049 (014-00950) or equivalent
Traction Battery High-Voltage Lockout and Diagnostic Tool 418-F207
Power Steering Interlock Tool 211-F006

(Continued)

**Special Tool(s)**

Auxiliary Interlock Tool 418-F208
Traction Battery High-Voltage Service Cord 418-F218
Traction Battery Low-Voltage Service Cord 418-F219
High-Voltage Insulated Safety Gloves 100-F036 or equivalent
Face Shield 100-F035 or equivalent

**PINPOINT TEST A: DTC C1839 LEAKAGE FAULT**

TEST STEP	ACTION TO TAKE
<p><b>A1 CHECK FOR CURRENT LEAKAGE</b></p> <ul style="list-style-type: none"> <li>With key ON, monitor battery control module (BCM) PIDs LEAK__DF, LEAKHCF, and LEAKLCF.</li> <li>Wait approximately 50 seconds.</li> <li><b>Do any of the PIDs indicate YES?</b></li> </ul>	<p>Yes = GO to <b>A7</b> (leakage is in vehicle somewhere).</p> <p>No = GO to <b>A2</b> (leakage circuit failure).</p>
<p><b>A2 CHECK FOR LEAKAGE CIRCUIT FAILURE</b></p> <ul style="list-style-type: none"> <li>With key ON, monitor BCM PID LEAK__CF.</li> <li>Wait approximately two minutes.</li> </ul>	<p>Yes = GO to <b>A3</b>.</p>

(Continued)

**DIAGNOSIS AND TESTING (Continued)****PINPOINT TEST A: DTC C1839 LEAKAGE FAULT**

<b>TEST STEP</b>	<b>ACTION TO TAKE</b>
<ul style="list-style-type: none"> <li>Does the LEAK_CF PID indicate YES?</li> </ul>	No = CLEAR the BCM DTCs. DRIVE the vehicle. If the electrical hazard warning indicator illuminates and DTC C1839 still occurs, REPEAT test steps A1 and A2. If all PIDs still indicate NO, REPLACE the BCM. Otherwise, continue as indicated.
<b>A3 CHECK LOW-LEVEL CURRENT LEAKAGE CIRCUIT 3213 (BK/LB) BETWEEN IN-LINE C1750M AND BCM FOR OPEN</b> <ul style="list-style-type: none"> <li>Remove the traction battery and connect Traction Battery High-Voltage Lockout and Diagnostic Tool to the traction battery high-voltage two-pin C3994M.</li> <li>Connect Traction Battery High-Voltage Service Cord to traction battery support tray in-line C1935F and in-line C1935M.</li> </ul> <p><b>⚠ WARNING: The traction battery contains high-voltage components and wiring. High-voltage insulated safety gloves and face shield must be worn when carrying out the following steps. Failure to follow this warning may result in severe personal injury or death.</b></p> <ul style="list-style-type: none"> <li>Connect Traction Battery Low-Voltage Service Cord to traction battery support tray in-line C1939F and in-line C1939M.</li> <li>With key OFF, disconnect BCM high-voltage C1865.</li> <li>With key OFF, disconnect in-line C1750 (label A) and measure the resistance of the BK/LB wire between pin 7 on BCM high-voltage C1865 and in-line C1750M.</li> <li>Is the resistance less than 5 ohms?</li> </ul>	Yes = GO to A4.  No = REPLACE high-voltage harness (10B694).
<b>A4 CHECK LOW-LEVEL CURRENT LEAKAGE CIRCUIT BETWEEN IN-LINE C1750F AND BATTERY MODULE 1 FOR OPEN</b> <ul style="list-style-type: none"> <li>With key OFF, measure the resistance between the BK/LB wire on in-line C1750F and battery module 1 negative (-) post.</li> <li>Is the resistance between 28,000 and 34,000 ohms?</li> </ul>	Yes = GO to A5.  No = REPLACE high-voltage harness (14A280-AB).
<b>A5 CHECK HIGH-LEVEL CURRENT LEAKAGE CIRCUIT 3212 (DB) BETWEEN IN-LINE C1747M AND BCM FOR OPEN</b> <ul style="list-style-type: none"> <li>With key OFF, disconnect BCM high-voltage C1866.</li> <li>With key OFF, disconnect in-line C1747 (label N) and measure the resistance of the DB wire between pin 40 on BCM high-voltage C1866 and in-line C1747M.</li> <li>Is the resistance less than 5 ohms?</li> </ul>	Yes = GO to A6. No = REPLACE high-voltage harness (10B694).
<b>A6 CHECK HIGH-LEVEL CURRENT LEAKAGE CIRCUIT 3212 (DB) BETWEEN IN-LINE C1747F AND BATTERY MODULE 39 FOR OPEN</b>	

(Continued)

**DIAGNOSIS AND TESTING (Continued)****PINPOINT TEST A: DTC C1839 LEAKAGE FAULT**

TEST STEP	ACTION TO TAKE
<ul style="list-style-type: none"> <li>• With key OFF, measure the resistance between the DB wire on in-line C1747F and battery module 25 positive (+) post.</li>   <li>• <b>Is the resistance between 28,000 and 34,000 ohms?</b></li> </ul>	<p>Yes = CLEAR the BCM DTCs. DRIVE the vehicle. If the electrical hazard warning indicator illuminates and DTC C1839 still occurs, REPEAT test steps A1 and A2. If all PIDs still indicate NO, REPLACE the BCM. Otherwise, continue as indicated.</p> <p>No = REPLACE high-voltage harness (14A280-NC).</p>
<p><b>A7 CHECK PARALLEL COMBINATION (TB+ AND TB-) OF CURRENT LEAKAGE RESISTANCE</b></p> <ul style="list-style-type: none"> <li>• With key ON, monitor BCM PID LEAKRES.</li> <li>• Wait approximately 50 seconds.</li> <li>• <b>Does the LEAKRES PID indicate less than 50,000 ohms?</b></li> </ul>	<p>Yes = GO to A9.</p> <p>No = GO to A8.</p>
<p><b>A8 CHECK FOR CURRENT LEAKAGE IN TRACTION BATTERY CHARGER POSITIVE (+) BUS</b></p> <ul style="list-style-type: none"> <li>• With key ON, enter BCM active command mode CONTACTOR OUTPUT CONTROL, monitor BCM PID LKRESB+, and set the active command CHARGER to CLOSE.</li> <li>• Wait approximately 50 seconds.</li> <li>• <b>Does the LKRESB+ PID indicate less than 50,000 ohms?</b></li> </ul>	<p>Yes = GO to A50.</p> <p>No = GO to A11.</p>
<p><b>A9 CHECK FOR CURRENT LEAKAGE IN THE HIGH-VOLTAGE NEGATIVE BUS (TB-)</b></p> <ul style="list-style-type: none"> <li>• With key ON, monitor BCM PID LKRESB- (current leakage measurement between TB- and chassis ground).</li> <li>• Wait approximately 50 seconds.</li> <li>• <b>Does the LKRESB- PID indicate less than 50,000 ohms?</b></li> </ul>	<p>Yes = GO to A29 (leakage is in TB- bus).</p> <p>No = GO to A10.</p>
<p><b>A10 CHECK FOR CURRENT LEAKAGE IN THE HIGH-VOLTAGE POSITIVE BUS (TB+)</b></p> <ul style="list-style-type: none"> <li>• With key ON, monitor BCM PID LKRESB+ (current leakage measurement between TB+ and chassis ground).</li> <li>• Wait approximately 50 seconds.</li> <li>• <b>Does the LKRESB+ PID indicate less than 50,000 ohms?</b></li> </ul>	<p>Yes = GO to A43 (leakage is in TB+ bus).</p> <p>No = GO to A16.</p>
<p><b>A11 CHECK FOR CURRENT LEAKAGE IN THE TRACTION MOTOR</b></p> <ul style="list-style-type: none"> <li>• Raise the vehicle on a hoist.</li> </ul>	<p>Yes = GO to A14 (leakage is in TIM or traction motor).</p>

(Continued)

**DIAGNOSIS AND TESTING (Continued)****PINPOINT TEST A: DTC C1839 LEAKAGE FAULT**

<b>TEST STEP</b>	<b>ACTION TO TAKE</b>
<ul style="list-style-type: none"> <li>• Turn the ignition key to the START position, set the gear selector lever to the Drive (D) position, and monitor BCM PID LEAKRES.</li> <li>• Wait approximately 50 seconds.</li> <li>• <b>Does the LEAKRES PID indicate less than 50,000 ohms?</b></li> </ul>	No = If vehicle is equipped with A/C, GO to <b>A12</b> . If not, CLEAR the BCM DTCs. DRIVE the vehicle. If the electrical hazard warning indicator illuminates and DTC C1839 still occurs, REPEAT test steps A1 and A2. If all PIDs still indicate NO, CHECK the traction battery support tray for excessive moisture or water build-up. If OK, REPLACE the BCM.
<b>A12 CHECK FOR CURRENT LEAKAGE IN A/C INVERTER MOTOR CONTROLLER (IMC) OR A/C COMPRESSOR</b> <ul style="list-style-type: none"> <li>• Depress the brake pedal and set the gear selector lever to the Park (P) position.</li> <li>• With key ON, set the mode select knob to the A/C position, the temperature control knob to the full cool position, and the blower control knob to the high speed position, and monitor BCM PID LEAKRES.</li> <li>• Wait approximately 50 seconds.</li> <li>• <b>Does the LEAKRES PID indicate less than 50,000 ohms?</b></li> </ul>	Yes = GO to <b>A13</b> .  No = CLEAR the BCM DTCs. DRIVE the vehicle. If the electrical hazard warning indicator illuminates and DTC C1839 still occurs, REPEAT test steps A1 and A2. If all PIDs still indicate NO, CHECK the traction battery support tray for excessive moisture or water build-up. If OK, REPLACE the BCM.
<b>A13 CHECK FOR CURRENT LEAKAGE IN A/C COMPRESSOR</b> <ul style="list-style-type: none"> <li>• With key OFF, disconnect A/C inverter motor controller (IMC) high-voltage C1902 (to A/C compressor).</li> <li>• With key ON, monitor BCM PID LEAKRES.</li> <li>• Wait approximately 50 seconds.</li> <li>• <b>Does the LEAKRES PID indicate less than 50,000 ohms?</b></li> </ul>	Yes = REPLACE A/C IMC. REFER to Section 412-03.  No = REPLACE the A/C compressor. REFER to Section 412-03.
<b>A14 CHECK FOR CURRENT LEAKAGE IN TIM OR TRACTION MOTOR</b> <ul style="list-style-type: none"> <li>• With key OFF, disconnect the traction motor three-phase cables from the TIM, and reconnect the traction battery high-voltage two-pin C3994.</li> <li>• With key ON, monitor BCM PID LEAKRES.</li> <li>• Wait approximately 50 seconds.</li> <li>• <b>Does the LEAKRES PID indicate less than 50,000 ohms?</b></li> </ul>	Yes = GO to <b>A15</b> (leakage is in TIM or high-voltage cables to TIM).  No = REPLACE the motor/transaxle. REFER to Section 303-01.
<b>A15 CHECK FOR CURRENT LEAKAGE IN TIM OR HIGH-VOLTAGE CABLES LEADING TO TIM</b> <ul style="list-style-type: none"> <li>• With key OFF, check the high-voltage cables to the TIM to see if the positive (+) or negative (-) cables are touching chassis ground.</li> <li>• <b>Are any of the cables touching chassis ground?</b></li> </ul>	Yes = REPLACE high-voltage harness (14B322).  No = REPLACE the TIM. REFER to Section 303-14.
<b>A16 CHECK FOR CURRENT LEAKAGE IN TRACTION BATTERY SUPPORT TRAY, TRACTION INVERTER MODULE (TIM), MOTOR/TRANSAXLE, OR IN THE AUXILIARY NEGATIVE BUS FOR THE HIGH-VOLTAGE AUXILIARY LOAD COMPONENTS</b>	

(Continued)



**DIAGNOSIS AND TESTING (Continued)****PINPOINT TEST A: DTC C1839 LEAKAGE FAULT**

<b>TEST STEP</b>	<b>ACTION TO TAKE</b>
<ul style="list-style-type: none"> <li>• With key OFF, disconnect high-voltage auxiliary load in-line C1935 on the traction battery support tray.</li> <li>• Connect Auxiliary Interlock Tool to the high-voltage auxiliary load in-line C1935 on the traction battery support tray and in-line interlock C1948 (located behind the high voltage power distribution box [HVPDB]).</li> <li>• With key ON, monitor BCM PID LEAKRES.</li> <li>• Wait approximately 50 seconds.</li> <li>• <b>Does the LEAKRES PID indicate less than 50,000 ohms?</b></li> </ul>	<p>Yes = GO to <b>A24</b> (leakage is in traction battery support tray, TIM, or traction motor).</p> <p>No = GO to <b>A17</b> (leakage is in the auxiliary negative bus).</p>
<p><b>A17 CHECK FOR CURRENT LEAKAGE IN POWER STEERING ASSEMBLY</b></p> <ul style="list-style-type: none"> <li>• With key OFF, remove Auxiliary Interlock Tool, and reconnect in-line interlock C1948 and high-voltage auxiliary load in-line C1935 to the traction battery support tray.</li> <li>• With key OFF, disconnect power steering assembly high-voltage C1895.</li> <li>• Connect Power Steering Interlock Tool to power steering assembly C1895.</li> <li>• With key ON, monitor BCM PID LEAKRES.</li> <li>• Wait approximately 50 seconds.</li> <li>• <b>Does the LEAKRES PID indicate less than 50,000 ohms?</b></li> </ul>	<p>Yes = GO to <b>A18</b>.</p> <p>No = REPLACE the power steering assembly. REFER to Section 211-02.</p>
<p><b>A18 CHECK FOR CURRENT LEAKAGE IN A/C COMPRESSOR</b></p> <ul style="list-style-type: none"> <li>• With key OFF, disconnect A/C inverter motor controller (IMC) high-voltage C1902 (to A/C compressor).</li> <li>• With key ON, monitor BCM PID LEAKRES.</li> <li>• Wait approximately 50 seconds.</li> <li>• <b>Does the LEAKRES PID indicate less than 50,000 ohms?</b></li> </ul>	<p>Yes = GO to <b>A19</b>.</p> <p>No = REPLACE the A/C compressor. REFER to Section 412-03.</p>
<p><b>A19 CHECK FOR CURRENT LEAKAGE IN A/C IMC</b></p> <ul style="list-style-type: none"> <li>• With key OFF, remove the high voltage power distribution box (HVPDB) cover and disconnect HVPDB C1917 (to A/C IMC).</li> <li>• Reinstall the HVPDB cover.</li> <li>• With key ON, monitor BCM PID LEAKRES.</li> <li>• Wait approximately 50 seconds.</li> <li>• <b>Does the LEAKRES PID indicate less than 50,000 ohms?</b></li> </ul>	<p>Yes = GO to <b>A20</b>.</p> <p>No = REPLACE the A/C IMC. REFER to Section 412-03.</p>
<p><b>A20 CHECK FOR CURRENT LEAKAGE IN POSITIVE TEMPERATURE COEFFICIENT (PTC) HEATER</b></p> <ul style="list-style-type: none"> <li>• With key OFF, disconnect PTC switching module high-voltage C1912.</li> <li>• With key ON, monitor BCM PID LEAKRES.</li> <li>• Wait approximately 50 seconds.</li> <li>• <b>Does the LEAKRES PID indicate less than 50,000 ohms?</b></li> </ul>	<p>Yes = GO to <b>A21</b>.</p> <p>No = REPLACE the PTC heater. REFER to Section 412-02.</p>
<p><b>A21 CHECK FOR CURRENT LEAKAGE IN PTC SWITCHING MODULE</b></p> <ul style="list-style-type: none"> <li>• With key OFF, remove the HVPDB cover and disconnect HVPDB C1920 (to PTC switching module).</li> <li>• Reinstall the HVPDB cover.</li> <li>• With key ON, monitor BCM PID LEAKRES.</li> <li>• Wait approximately 50 seconds.</li> <li>• <b>Does the LEAKRES PID indicate less than 50,000 ohms?</b></li> </ul>	<p>Yes = GO to <b>A22</b>.</p> <p>No = REPLACE the PTC switching module. REFER to Section 412-02.</p>
<p><b>A22 CHECK FOR CURRENT LEAKAGE IN DC/DC CONVERTER</b></p> <ul style="list-style-type: none"> <li>• With key OFF, remove the HVPDB cover and disconnect HVPDB C1914 (to DC/DC converter).</li> </ul>	<p>Yes = GO to <b>A23</b>.</p>

(Continued)

**DIAGNOSIS AND TESTING (Continued)****PINPOINT TEST A: DTC C1839 LEAKAGE FAULT**

TEST STEP	ACTION TO TAKE
<ul style="list-style-type: none"> <li>• Reinstall the HVPDB cover.</li> <li>• With key ON, monitor BCM PID LEAKRES.</li> <li>• Wait approximately 50 seconds.</li> <li>• <b>Does the LEAKRES PID indicate less than 50,000 ohms?</b></li> </ul>	No = REPLACE the DC/DC converter. REFER to Section 414-02.
<b>A23 CHECK FOR CURRENT LEAKAGE IN TRACTION BATTERY CHARGER</b> <ul style="list-style-type: none"> <li>• With key OFF, remove the HVPDB cover and disconnect HVPDB C1923 (to traction battery charger).</li> <li>• Reinstall the HVPDB cover.</li> <li>• With key ON, monitor BCM PID LEAKRES.</li> <li>• Wait approximately 50 seconds.</li> <li>• <b>Does the LEAKRES PID indicate less than 50,000 ohms?</b></li> </ul>	Yes = REPLACE the HVPDB.  No = REPLACE the traction battery charger.
<b>A24 CHECK FOR CURRENT LEAKAGE IN TRACTION BATTERY SUPPORT TRAY, TIM, OR TRACTION MOTOR</b> <ul style="list-style-type: none"> <li>• With key OFF, disconnect the traction battery high-voltage two-pin C3994 and connect Traction Battery High-Voltage Lockout and Diagnostic Tool to the traction battery high-voltage two-pin C3994M.</li> <li>• With key ON, monitor BCM PID LEAKRES.</li> <li>• Wait approximately 50 seconds.</li> <li>• <b>Does the LEAKRES PID indicate less than 50,000 ohms?</b></li> </ul>	Yes = GO to <b>A27</b> (leakage is in traction battery support tray).  No = GO to <b>A25</b> (leakage is in TIM or traction motor).
<b>A25 CHECK FOR CURRENT LEAKAGE IN TIM OR TRACTION MOTOR</b> <ul style="list-style-type: none"> <li>• With key OFF, disconnect the traction motor three-phase cables from the TIM, and reconnect the traction battery high-voltage two-pin C3994.</li> <li>• With key ON, monitor BCM PID LEAKRES.</li> <li>• Wait approximately 50 seconds.</li> <li>• <b>Does the LEAKRES PID indicate less than 50,000 ohms?</b></li> </ul>	Yes = GO to <b>A26</b> (leakage is in TIM or high-voltage cables to TIM).  No = REPLACE the motor/transaxle. REFER to Section 303-01.
<b>A26 CHECK FOR CURRENT LEAKAGE IN TIM OR HIGH-VOLTAGE CABLES LEADING TO TIM</b> <ul style="list-style-type: none"> <li>• With key OFF, check the high-voltage cables to the TIM to see if the positive (+) or negative (-) cables are touching chassis ground.</li> <li>• <b>Are any of the cables touching chassis ground?</b></li> </ul>	Yes = REPLACE high-voltage harness (14B322).  No = REPLACE the TIM. REFER to Section 303-14.
<b>A27 CHECK FOR CURRENT LEAKAGE IN HIGH-VOLTAGE NEGATIVE BUS (TB-) (INSIDE TRACTION BATTERY SUPPORT TRAY)</b> <p><b>NOTE:</b> The BCM active command CHARGER must be sent before the BCM active command NEG MAIN is sent.</p> <ul style="list-style-type: none"> <li>• With key ON, enter BCM active command mode CONTACTOR OUTPUT CONTROL, monitor BCM PID LEAKRES, and set the active command CHARGER to CLOSE.</li> <li>• Set the active command NEG MAIN to OPEN.</li> <li>• Wait approximately 50 seconds.</li> <li>• <b>Does the LEAKRES PID indicate less than 50,000 ohms?</b></li> </ul>	Yes = GO to <b>A28</b> (leakage is in battery module voltage sense lines or contactor box).  No = REPLACE the contactor box.
<b>A28 CHECK FOR CURRENT LEAKAGE IN BATTERY MODULE VOLTAGE SENSE LINES</b> <ul style="list-style-type: none"> <li>• With key ON, monitor BCM PID LEAK__ID and note the indicated battery module.</li> </ul>	Yes = REPLACE high-voltage harness (10B694) and/or the high-voltage harness (14A280) in question.

(Continued)

**DIAGNOSIS AND TESTING (Continued)****PINPOINT TEST A: DTC C1839 LEAKAGE FAULT**

TEST STEP	ACTION TO TAKE
<p><b>NOTE:</b> If there is no continuity between the indicated battery module and chassis ground, check for continuity between chassis ground and the positive (+) posts of the two battery modules before and after the indicated battery module.</p> <ul style="list-style-type: none"> <li>With key OFF, disconnect BCM C1865 and C1866, and check for continuity between the positive (+) post of the indicated battery module and chassis ground.</li> <li><b>Is there continuity?</b></li> </ul>	<p>No = REPLACE the contactor box.</p>
<p><b>A29 CHECK FOR CURRENT LEAKAGE IN HIGH-VOLTAGE NEGATIVE BUS (TB-) (INSIDE TRACTION BATTERY SUPPORT TRAY)</b></p> <p><b>NOTE:</b> The BCM active command CHARGER must be sent before the BCM active command NEG MAIN is sent.</p> <ul style="list-style-type: none"> <li>With key ON, enter BCM active command mode CONTACTOR OUTPUT CONTROL, monitor BCM PID LKRESB-, and set the active command CHARGER to CLOSE.</li> <li>Set the active command NEG MAIN to OPEN.</li> <li>Wait approximately 50 seconds.</li> <li><b>Does the LKRESB- PID indicate less than 50,000 ohms?</b></li> </ul>	<p>Yes = GO to <b>A30</b> (leakage is in contactor box or battery module voltage sense lines).</p> <p>No = GO to <b>A32</b>.</p>
<p><b>A30 CHECK FOR CURRENT LEAKAGE IN BATTERY MODULE VOLTAGE SENSE LINES</b></p> <ul style="list-style-type: none"> <li>With key ON, monitor BCM PID LEAK_ID and note the indicated battery module.</li> </ul> <p><b>NOTE:</b> If there is no continuity between the indicated battery module and chassis ground, check for continuity between chassis ground and the positive (+) posts of the two battery modules before and after the indicated battery module.</p> <ul style="list-style-type: none"> <li>With key OFF, disconnect BCM C1865 and C1866, and check for continuity between the positive (+) post of the indicated battery module and chassis ground.</li> <li><b>Is there continuity?</b></li> </ul>	<p>Yes = REPLACE high-voltage harness (10B694) and/or the high-voltage harness (14A280) in question.</p> <p>No = GO to <b>A31</b>.</p>
<p><b>A31 CHECK FOR CURRENT LEAKAGE IN CONTACTOR BOX</b></p> <ul style="list-style-type: none"> <li>With key OFF, disconnect the negative contactor box cable leading to the traction battery 250A high-voltage fuse.</li> </ul> <p><b>NOTE:</b> The BCM active command CHARGER must be sent before the BCM active command NEG MAIN is sent.</p> <ul style="list-style-type: none"> <li>With key ON, enter BCM active command mode CONTACTOR OUTPUT CONTROL, monitor BCM PID LKRESB-, and set the active command CHARGER to CLOSE.</li> <li>Set the active command NEG MAIN to OPEN.</li> <li>Wait approximately 50 seconds.</li> <li><b>Does the LKRESB- PID indicate less than 50,000 ohms?</b></li> </ul>	<p>Yes = REPLACE the BCM.</p> <p>No = REPLACE the contactor box.</p>
<p><b>A32 CHECK FOR CURRENT LEAKAGE IN TRACTION BATTERY SUPPORT TRAY, TRACTION INVERTER MODULE (TIM), MOTOR/TRANSAXLE, OR IN THE AUXILIARY NEGATIVE BUS FOR THE HIGH-VOLTAGE AUXILIARY LOAD COMPONENTS</b></p> <ul style="list-style-type: none"> <li>With key OFF, disconnect high-voltage auxiliary load in-line C1935 on the traction battery support tray.</li> </ul>	<p>Yes = GO to <b>A33</b> (leakage is in contactor box, TIM, or traction motor).</p>

(Continued)

**DIAGNOSIS AND TESTING (Continued)****PINPOINT TEST A: DTC C1839 LEAKAGE FAULT**

TEST STEP	ACTION TO TAKE
<ul style="list-style-type: none"> <li>• With key ON, enter the TIM active command mode CONTACTOR OUTPUT CONTROL, monitor the BCM PID LKRESB-, and set the active command PRECHG IN to CLOSE.</li> <li>• Wait approximately 50 seconds.</li> <li>• <b>Does the LKRESB- PID indicate less than 50,000 ohms?</b></li> </ul>	No = GO to <b>A36</b> (leakage is in the auxiliary negative bus).
<b>A33 CHECK FOR CURRENT LEAKAGE IN CONTACTOR BOX, TIM, OR TRACTION MOTOR</b> <ul style="list-style-type: none"> <li>• With key OFF, disconnect the traction battery high-voltage two-pin C3994 and connect Traction Battery High-Voltage Lockout and Diagnostic Tool to the traction battery high-voltage two-pin C3994M.</li> <li>• With key ON, enter the TIM active command mode CONTACTOR OUTPUT CONTROL, monitor the BCM PID LKRESB-, and set the active command PRECHG IN to CLOSE.</li> <li>• Wait approximately 50 seconds.</li> <li>• <b>Does the LKRESB- PID indicate less than 50,000 ohms?</b></li> </ul>	Yes = REPLACE the contactor box.  No = GO to <b>A34</b> (leakage is in TIM or traction motor).
<b>A34 CHECK FOR CURRENT LEAKAGE IN TIM OR TRACTION MOTOR</b> <ul style="list-style-type: none"> <li>• With key OFF, remove the Traction Battery High-Voltage Lockout and Diagnostic Tool, disconnect the traction motor three-phase cables from the TIM, and reconnect the traction battery high-voltage two-pin C3994.</li> <li>• With key ON, monitor BCM PIDs LKRESB+ and LKRESB-.</li> <li>• Wait approximately 50 seconds.</li> <li>• <b>Does the LKRESB+ or LKRESB- PID indicate less than 50,000 ohms?</b></li> </ul>	Yes = GO to <b>A35</b> (leakage is in TIM or high-voltage cables to TIM).  No = REPLACE the motor/transaxle. REFER to Section 303-01.
<b>A35 CHECK FOR CURRENT LEAKAGE IN TIM OR HIGH-VOLTAGE CABLES LEADING TO TIM</b> <ul style="list-style-type: none"> <li>• With key OFF, check the high-voltage cables to the TIM to see if the positive (+) or negative (-) cables are touching chassis ground.</li> <li>• <b>Are any of the cables touching chassis ground?</b></li> </ul>	Yes = REPLACE high-voltage harness (14B322).  No = REPLACE the TIM. REFER to Section 303-14.
<b>A36 CHECK FOR CURRENT LEAKAGE IN POWER STEERING ASSEMBLY</b> <ul style="list-style-type: none"> <li>• With key OFF, reconnect high-voltage auxiliary load in-line C1935 to the traction battery support tray.</li> <li>• With key OFF, disconnect power steering assembly high-voltage C1895.</li> <li>• Connect Power Steering Interlock Tool to power steering assembly C1895.</li> <li>• With key ON, monitor BCM PID LKRESB-.</li> <li>• Wait approximately 50 seconds.</li> <li>• <b>Does the LKRESB- PID indicate less than 50,000 ohms?</b></li> </ul>	Yes = GO to <b>A37</b> .  No = REPLACE the power steering assembly. REFER to Section 211-02.
<b>A37 CHECK FOR CURRENT LEAKAGE IN A/C COMPRESSOR</b> <ul style="list-style-type: none"> <li>• With key OFF, disconnect A/C inverter motor controller (IMC) high-voltage C1902 (to A/C compressor).</li> <li>• With key ON, monitor BCM PID LKRESB-.</li> <li>• Wait approximately 50 seconds.</li> <li>• <b>Does the LKRESB- PID indicate less than 50,000 ohms?</b></li> </ul>	Yes = GO to <b>A38</b> .  No = REPLACE the A/C compressor. REFER to Section 412-03.
<b>A38 CHECK FOR CURRENT LEAKAGE IN A/C IMC</b> <ul style="list-style-type: none"> <li>• With key OFF, remove the high voltage power distribution box (HVPDB) cover and disconnect HVPDB C1917 (to A/C IMC).</li> <li>• Reinstall the HVPDB cover.</li> <li>• With key ON, monitor BCM PID LKRESB-.</li> <li>• Wait approximately 50 seconds.</li> <li>• <b>Does the LKRESB- PID indicate less than 50,000 ohms?</b></li> </ul>	Yes = GO to <b>A39</b> .  No = REPLACE the A/C IMC. REFER to Section 412-03.

(Continued)

**DIAGNOSIS AND TESTING (Continued)****PINPOINT TEST A: DTC C1839 LEAKAGE FAULT**

<b>TEST STEP</b>	<b>ACTION TO TAKE</b>
<b>A39 CHECK FOR CURRENT LEAKAGE IN POSITIVE TEMPERATURE COEFFICIENT (PTC) HEATER</b> <ul style="list-style-type: none"> <li>• With key OFF, disconnect PTC switching module high-voltage C1912.</li> <li>• With key ON, monitor BCM PID LKRESB-.</li> <li>• Wait approximately 50 seconds.</li> <li>• <b>Does the LKRESB- PID indicate less than 50,000 ohms?</b></li> </ul>	Yes = GO to <b>A40</b> . No = REPLACE the PTC heater. REFER to Section 412-02.
<b>A40 CHECK FOR CURRENT LEAKAGE IN PTC SWITCHING MODULE</b> <ul style="list-style-type: none"> <li>• With key OFF, remove the HVPDB cover and disconnect HVPDB C1920 (to PTC switching module).</li> <li>• Reinstall the HVPDB cover.</li> <li>• With key ON, monitor BCM PID LKRESB-.</li> <li>• Wait approximately 50 seconds.</li> <li>• <b>Does the LKRESB- PID indicate less than 50,000 ohms?</b></li> </ul>	Yes = GO to <b>A41</b> . No = REPLACE the PTC switching module. REFER to Section 412-02.
<b>A41 CHECK FOR CURRENT LEAKAGE IN DC/DC CONVERTER</b> <ul style="list-style-type: none"> <li>• With key OFF, remove the HVPDB cover and disconnect HVPDB C1914 (to DC/DC converter).</li> <li>• Reinstall the HVPDB cover.</li> <li>• With key ON, monitor BCM PID LKRESB-.</li> <li>• Wait approximately 50 seconds.</li> <li>• <b>Does the LKRESB- PID indicate less than 50,000 ohms?</b></li> </ul>	Yes = GO to <b>A42</b> . No = REPLACE the DC/DC converter. REFER to Section 414-02.
<b>A42 CHECK FOR CURRENT LEAKAGE IN TRACTION BATTERY CHARGER</b> <ul style="list-style-type: none"> <li>• With key OFF, remove the HVPDB cover and disconnect HVPDB C1923 (to traction battery charger).</li> <li>• Reinstall the HVPDB cover.</li> <li>• With key ON, monitor BCM PID LKRESB-.</li> <li>• Wait approximately 50 seconds.</li> <li>• <b>Does the LKRESB- PID indicate less than 50,000 ohms?</b></li> </ul>	Yes = REPLACE the HVPDB. No = REPLACE the traction battery charger.
<b>A43 CHECK FOR CURRENT LEAKAGE IN HIGH-VOLTAGE POSITIVE BUS (TB+) (INSIDE TRACTION BATTERY SUPPORT TRAY)</b> <p><b>NOTE:</b> The ignition key must be in the OFF position when carrying out this test step and you must wait approximately three minutes for the results.</p> <ul style="list-style-type: none"> <li>• With key OFF, monitor BCM PID LKRESB+.</li> <li>• Wait approximately three minutes.</li> <li>• <b>Does the LKRESB+ PID indicate less than 50,000 ohms?</b></li> </ul>	Yes = GO to <b>A49</b> (leakage is in contactor box or battery module voltage sense lines). No = GO to <b>A44</b> (leakage is in auxiliary load + bus, TIM, or traction motor).
<b>A44 CHECK FOR CURRENT LEAKAGE IN THE AUXILIARY POSITIVE (+) BUS (INSIDE TRACTION BATTERY SUPPORT TRAY) BETWEEN THE CONTACTOR BOX RELAYS AND TB+</b> <ul style="list-style-type: none"> <li>• With key OFF, disconnect high-voltage auxiliary load in-line C1935 on the traction battery support tray.</li> </ul>	Yes = GO to <b>A45</b> (leakage is in TIM or traction motor)

(Continued)

**DIAGNOSIS AND TESTING (Continued)****PINPOINT TEST A: DTC C1839 LEAKAGE FAULT**

TEST STEP	ACTION TO TAKE
<p><b>NOTE:</b> The active command PRECHG IN must be sent before sending the active command POS MAIN. If not, New Generation STAR (NGS) Tester will indicate UNABLE TO PERFORM TEST/FUNCTION.</p> <ul style="list-style-type: none"> <li>With key ON, enter TIM active command mode CONTACTOR OUTPUT CONTROL, monitor BCM PID LKRESB+, and set the active commands PRECHG IN to CLOSE and POS MAIN to CLOSE.</li> <li>Wait approximately 50 seconds.</li> <li><b>Does the LKRESB+ PID indicate less than 50,000 ohms?</b></li> </ul>	<p>No = GO to <b>A47</b> (leakage is in auxiliary load + bus or traction battery charger + bus).</p>
<p><b>A45 CHECK FOR CURRENT LEAKAGE IN TIM OR TRACTION MOTOR</b></p> <ul style="list-style-type: none"> <li>With key OFF, disconnect the traction battery high-voltage two-pin C3994 and the traction motor three-phase cables from the TIM, and reconnect the traction battery high-voltage two-pin C3994.</li> <li>With key ON, enter TIM active command mode CONTACTOR OUTPUT CONTROL, monitor BCM PIDs LKRESB+ and LKRESB-, and set the active commands PRECHG IN to CLOSE and POS MAIN to CLOSE.</li> <li>Wait approximately 50 seconds.</li> <li><b>Does the LKRESB+ or LKRESB- PID indicate less than 50,000 ohms?</b></li> </ul>	<p>Yes = GO to <b>A46</b> (leakage is in TIM or high-voltage cables leading to TIM).</p> <p>No = REPLACE the motor/transaxle. REFER to Section 303-01.</p>
<p><b>A46 CHECK FOR CURRENT LEAKAGE IN TIM OR HIGH-VOLTAGE CABLES LEADING TO TIM</b></p> <ul style="list-style-type: none"> <li>With key OFF, check the high-voltage cable to the TIM to see if the positive (+) or negative (-) cables are touching chassis ground.</li> <li><b>Are any of the cables touching chassis ground?</b></li> </ul>	<p>Yes = REPLACE high-voltage harness (14B322).</p> <p>No = REPLACE the TIM. REFER to Section 303-14.</p>
<p><b>A47 CHECK FOR CURRENT LEAKAGE IN AUXILIARY LOAD POSITIVE (+) BUS OR TRACTION BATTERY CHARGER POSITIVE (+) BUS</b></p> <ul style="list-style-type: none"> <li>With key OFF, disconnect the traction battery high-voltage two-pin C3994 and connect Traction Battery High-Voltage Lockout and Diagnostic Tool to the traction battery high-voltage two-pin C3994M.</li> <li>With key OFF, reconnect high-voltage auxiliary load in-line C1935 to the traction battery support tray.</li> <li>With key ON, monitor BCM PID LKRESB+.</li> <li>Wait approximately 50 seconds.</li> <li><b>Does the LKRESB+ PID indicate less than 50,000 ohms?</b></li> </ul>	<p>Yes = GO to <b>A51</b> (leakage is in auxiliary load + bus).</p> <p>No = GO to <b>A48</b> (leakage is in traction battery charger + bus).</p>
<p><b>A48 CHECK FOR CURRENT LEAKAGE IN CONTACTOR BOX, BATTERY HEATER HARNESS (IF EQUIPPED), TRACTION BATTERY CHARGER, OR HVPDB</b></p> <ul style="list-style-type: none"> <li>With key OFF, disconnect high-voltage auxiliary load in-line C1935 on the traction battery support tray.</li> <li>Connect Auxiliary Interlock Tool to the high-voltage auxiliary load in-line C1935 on the traction battery support tray and in-line interlock C1948 (located behind the HVPDB).</li> <li>With key OFF, disconnect interface adapter assembly (IAA) module C1945.</li> <li>With key ON, enter BCM active command mode CONTACTOR OUTPUT CONTROL, monitor BCM PID LKRESB+, and set the active command CHARGER to CLOSE.</li> <li>Wait approximately 50 seconds.</li> <li><b>Does the LKRESB+ PID indicate less than 50,000 ohms?</b></li> </ul>	<p>Yes = REPLACE the contactor box.</p> <p>No = GO to <b>A50</b> (leakage is in traction battery charger or HVPDB).</p>
<p><b>A49 CHECK FOR CURRENT LEAKAGE IN BATTERY MODULE VOLTAGE SENSE LINES</b></p>	

(Continued)

**DIAGNOSIS AND TESTING (Continued)****PINPOINT TEST A: DTC C1839 LEAKAGE FAULT**

<b>TEST STEP</b>	<b>ACTION TO TAKE</b>
<ul style="list-style-type: none"> <li>• With key ON, monitor BCM PID LEAK_ID and note the indicated battery module.</li> </ul> <p><b>NOTE:</b> If there is no continuity between the indicated battery module and chassis ground, check for continuity between chassis ground and the positive (+) posts of the two battery modules before and after the indicated battery module.</p> <ul style="list-style-type: none"> <li>• With key OFF, disconnect BCM C1865 and C1866, and check for continuity between the positive (+) post of the indicated battery module and chassis ground.</li> <li>• <b>Is there continuity?</b></li> </ul>	<p>Yes = REPLACE high-voltage harness (10B694) and/or the high-voltage harness (14A280) in question.</p> <p>No = REPLACE the contactor box.</p>
<p><b>A50 CHECK FOR CURRENT LEAKAGE IN TRACTION BATTERY CHARGER OR HVPDB</b></p> <ul style="list-style-type: none"> <li>• With key OFF, remove (if connected) Auxiliary Interlock Tool, and reconnect in-line interlock C1948 and high-voltage auxiliary load in-line C1935 to the traction battery support tray.</li> <li>• With key OFF, remove the high-voltage power distribution box (HVPDB) cover and disconnect HVPDB C1923 (to traction battery charger).</li> <li>• Reinstall the HVPDB cover.</li> <li>• With key ON, enter BCM active command mode CONTACTOR OUTPUT CONTROL, monitor BCM PID LKRESB+, and set the active command CHARGER to CLOSE.</li> <li>• Wait approximately 50 seconds.</li> <li>• <b>Does the LKRESB+ PID indicate less than 50,000 ohms?</b></li> </ul>	<p>Yes = REPLACE the HVPDB.</p> <p>No = REPLACE the traction battery charger.</p>
<p><b>A51 CHECK FOR CURRENT LEAKAGE IN AUXILIARY LOAD POSITIVE (+) BUS, CONTACTOR BOX, OR HVPDB</b></p> <ul style="list-style-type: none"> <li>• With key OFF, disconnect high-voltage auxiliary load in-line C1935 on the traction battery support tray.</li> <li>• Connect Auxiliary Interlock Tool to the high-voltage auxiliary load in-line C1935 on the traction battery support tray and in-line interlock C1948 (located behind the HVPDB).</li> <li>• With key ON, monitor BCM PID LKRESB+.</li> <li>• Wait approximately 50 seconds.</li> <li>• <b>Does the LKRESB+ PID indicate less than 50,000 ohms?</b></li> </ul>	<p>Yes = REPLACE the contactor box.</p> <p>No = GO to <b>A52</b> (leakage is in auxiliary load + bus or HVPDB).</p>
<p><b>A52 CHECK FOR CURRENT LEAKAGE IN POWER STEERING ASSEMBLY</b></p> <ul style="list-style-type: none"> <li>• With key OFF, remove Auxiliary Interlock Tool and reconnect in-line interlock C1948 and high-voltage auxiliary load in-line C1935 to the traction battery support tray.</li> <li>• With key OFF, disconnect power steering assembly high-voltage C1895.</li> <li>• Connect Power Steering Interlock Tool to power steering assembly C1895.</li> <li>• With key ON, monitor BCM PID LKRESB+.</li> <li>• Wait approximately 50 seconds.</li> <li>• <b>Does the LKRESB+ PID indicate less than 50,000 ohms?</b></li> </ul>	<p>Yes = GO to <b>A53</b>.</p> <p>No = REPLACE the power steering assembly. REFER to Section 211-02.</p>
<p><b>A53 CHECK FOR CURRENT LEAKAGE IN A/C COMPRESSOR</b></p> <ul style="list-style-type: none"> <li>• With key OFF, disconnect A/C inverter motor controller (IMC) high-voltage C1902 (to A/C compressor).</li> <li>• With key ON, monitor BCM PID LKRESB+.</li> <li>• Wait approximately 50 seconds.</li> <li>• <b>Does the LKRESB+ PID indicate less than 50,000 ohms?</b></li> </ul>	<p>Yes = GO to <b>A54</b>.</p> <p>No = REPLACE the A/C compressor. REFER to Section 412-03.</p>

(Continued)

**DIAGNOSIS AND TESTING (Continued)****PINPOINT TEST A: DTC C1839 LEAKAGE FAULT**

TEST STEP	ACTION TO TAKE
<b>A54 CHECK FOR CURRENT LEAKAGE IN A/C IMC</b> <ul style="list-style-type: none"> <li>• With key OFF, remove the high-voltage power distribution box (HVPDB) cover and disconnect HVPDB C1917 (to A/C IMC).</li> <li>• Reinstall the HVPDB cover.</li> <li>• With key ON, monitor BCM PID LKRESB+.</li> <li>• Wait approximately 50 seconds.</li> <li>• <b>Does the LKRESB+ PID indicate less than 50,000 ohms?</b></li> </ul>	Yes = GO to <b>A55</b> .  No = REPLACE the A/C IMC. REFER to Section 412-03.
<b>A55 CHECK FOR CURRENT LEAKAGE IN POSITIVE TEMPERATURE COEFFICIENT (PTC) HEATER</b> <ul style="list-style-type: none"> <li>• With key OFF, disconnect PTC switching module high-voltage C1912.</li> <li>• With key ON, monitor BCM PID LKRESB+.</li> <li>• Wait approximately 50 seconds.</li> <li>• <b>Does the LKRESB+ PID indicate less than 50,000 ohms?</b></li> </ul>	Yes = GO to <b>A56</b> . No = REPLACE the PTC heater. REFER to Section 412-02.
<b>A56 CHECK FOR CURRENT LEAKAGE IN PTC SWITCHING MODULE</b> <ul style="list-style-type: none"> <li>• With key OFF, remove the high-voltage power distribution box (HVPDB) cover and disconnect HVPDB C1920 (to PTC switching module).</li> <li>• Reinstall the HVPDB cover.</li> <li>• With key ON, monitor BCM PID LKRESB+.</li> <li>• Wait approximately 50 seconds.</li> <li>• <b>Does the LKRESB+ PID indicate less than 50,000 ohms?</b></li> </ul>	Yes = GO to <b>A57</b> .  No = REPLACE the PTC switching module. REFER to Section 412-02.
<b>A57 CHECK FOR CURRENT LEAKAGE IN DC/DC CONVERTER</b> <ul style="list-style-type: none"> <li>• With key OFF, remove the high-voltage power distribution box (HVPDB) cover and disconnect HVPDB C1914 (to DC/DC converter).</li> <li>• Reinstall the HVPDB cover.</li> <li>• With key ON, monitor BCM PID LKRESB+.</li> <li>• Wait approximately 50 seconds.</li> <li>• <b>Does the LKRESB+ PID indicate less than 50,000 ohms?</b></li> </ul>	Yes = REPLACE the HVPDB.  No = REPLACE the DC/DC converter. REFER to Section 414-02.

**Regenerative Braking****Diagnostic Trouble Code (DTC) Definition**

The following DTCs relate to the regenerative braking system:

- DTC C1446 Brake Switch Circuit Failure
  - The brake pedal position (BPP) switch provides a 12-volt input signal to the traction inverter module (TIM) when the brake pedal is depressed. The TIM sets DTC C1446 if master cylinder brake pressure is detected without the brake pedal depressed. If this occurs, the TIM disables regenerative braking, and the malfunction indicator lamp (MIL) and red brake warning indicator illuminate.

- DTC C1849 Master Cylinder Pressure Out of Range
  - The traction inverter module (TIM) uses the input signal from the master cylinder brake pressure sensor to determine the amount of regenerative braking to be applied. The normal range of the master cylinder brake pressure sensor is between 0.5 and 4.5 volts. The TIM sets DTC C1849 if the signal is out of range. If this occurs, the TIM disables regenerative braking, and the malfunction indicator lamp (MIL) and red brake warning indicator illuminate.

**Electrical Schematic**

Refer to Electrical and Vacuum Troubleshooting Manual, Cell 26, Motor/Transaxle Control for schematic and connector information.

**Inspection and Verification**

Refer to [Section 100-07](#).



**DIAGNOSIS AND TESTING (Continued)****Symptom Chart****Symptom Chart**

<b>Condition</b>	<b>Possible Sources</b>	<b>Action</b>
<ul style="list-style-type: none"> <li>DTC C1446 Brake Switch Circuit Failure</li> </ul>	<ul style="list-style-type: none"> <li>Fuse.</li> <li>Circuit(s).</li> <li>Traction inverter module (TIM).</li> <li>Brake pedal position (BPP) switch.</li> <li>Master cylinder brake pressure sensor.</li> </ul>	<ul style="list-style-type: none"> <li>GO to Pinpoint Test A.</li> </ul>
<ul style="list-style-type: none"> <li>DTC C1849 Master Cylinder Pressure Out of Range</li> </ul>	<ul style="list-style-type: none"> <li>Circuit(s).</li> <li>Master cylinder brake pressure sensor.</li> <li>Traction inverter module (TIM).</li> </ul>	<ul style="list-style-type: none"> <li>GO to Pinpoint Test B.</li> </ul>

**Pinpoint Tests****Special Tool(s)**

104-Pin Breakout Box (BOB) 418-049 (014-00950) or equivalent
BCM/TIM Breakout Box (BOB) Adapter Cable 418-F212
BCM/TIM Breakout Box (BOB) Overlay 418-F220

**PINPOINT TEST A: DTC C1446 BRAKE SWITCH CIRCUIT FAILURE**

<b>TEST STEP</b>	<b>ACTION TO TAKE</b>
<b>A1 CHECK BRAKE SWITCH STATUS</b> <ul style="list-style-type: none"> <li>With key ON, monitor the traction inverter module (TIM) PID BOO__TIM while depressing the brake pedal.</li> <li><b>Does the BOO__TIM PID indicate OFF with the brake pedal not depressed and ON with the brake pedal depressed?</b></li> </ul>	Yes = GO to A5. No = GO to A2.
<b>A2 CHECK FUSE AND POWER TO BRAKE PEDAL POSITION (BPP) SWITCH</b> <ul style="list-style-type: none"> <li>With key OFF, check 10A fuse 13 in the I/P fuse panel.</li> <li>With key OFF, disconnect BPP switch C210 and measure the voltage between pin 3 (LG/R wire) on BPP switch C210 and ground. (V &gt; 10 volts)</li> <li><b>Is everything OK?</b></li> </ul>	Yes = RECONNECT the BPP switch. GO to A3. No = REPAIR as necessary.
<b>A3 CHECK BPP SWITCH SIGNAL TO TIM</b> <ul style="list-style-type: none"> <li>Connect 104-Pin Breakout Box (BOB) to TIM C4998, C4999 using the BCM/TIM BOB Adapter Cable and Overlay; leave the TIM disconnected.</li> <li>With key ON, measure the voltage between BOB pin B14 and ground (BOB pin A29) with the brake pedal depressed.</li> <li><b>Is the voltage greater than 10 volts?</b></li> </ul>	Yes = REPLACE the TIM. REFER to Section 303-14. No = GO to A4.
<b>A4 CHECK CIRCUIT 810 (R/LG) FOR OPEN</b> <ul style="list-style-type: none"> <li>With key OFF, disconnect BPP switch C210 and measure the resistance of the R/LG wire between pin 4 on BPP switch C210 and BOB pin 14.</li> <li><b>Is the resistance less than 5 ohms?</b></li> </ul>	Yes = REPLACE the BPP switch. No = REPAIR the R/LG wire.

(Continued)

**DIAGNOSIS AND TESTING (Continued)****PINPOINT TEST A: DTC C1446 BRAKE SWITCH CIRCUIT FAILURE**

<b>TEST STEP</b>	<b>ACTION TO TAKE</b>
<b>A5 CHECK MASTER CYLINDER PRESSURE STATUS</b> <ul style="list-style-type: none"> <li>With key ON, monitor the TIM PID MC__PRES while depressing the brake pedal.</li> <li><b>Does the MC__PRES PID increase from approximately 0.45 to 4.65 volts as the brake pedal is depressed?</b></li> </ul>	Yes = System OK. CHECK wiring for intermittent connections. No = If MC__PRES decreases from approximately 4.60 to 4.10 volts, GO to <b>A6</b> . If MC__PRES is greater than 4.8 volts at all times, GO to <b>A8</b> .
<b>A6 CHECK MASTER CYLINDER BRAKE PRESSURE SENSOR GROUND REFERENCE CIRCUIT</b> <ul style="list-style-type: none"> <li>With key OFF, disconnect master cylinder brake pressure sensor C1940 and measure the resistance between the W/R wire on master cylinder brake pressure sensor C1940 and ground.</li> <li><b>Is the resistance less than 5 ohms?</b></li> </ul>	Yes = REPLACE the master cylinder brake pressure sensor. No = GO to <b>A7</b> .
<b>A7 CHECK CIRCUIT 3601 (W/R) FOR OPEN</b> <ul style="list-style-type: none"> <li>Connect 104-Pin Breakout Box (BOB) to TIM C4998, C4999 using the BCM/TIM BOB Adapter Cable and Overlay; leave the TIM disconnected.</li> <li>With key OFF, measure the resistance of the W/R wire between master cylinder brake pressure sensor C1940 and BOB pin B21.</li> <li><b>Is the resistance less than 5 ohms?</b></li> </ul>	Yes = REPLACE the TIM. REFER to Section 303-14. No = REPAIR the W/R wire.
<b>A8 CHECK CIRCUIT 3600 (R/W) FOR SHORT TO POWER</b> <ul style="list-style-type: none"> <li>Connect 104-Pin Breakout Box (BOB) to TIM C4998, C4999 using the BCM/TIM BOB Adapter Cable and Overlay; leave the TIM disconnected.</li> <li>With key OFF, disconnect master cylinder brake pressure sensor C1940.</li> <li>With key ON, measure the voltage between BOB pin B22 and ground (BOB pin A29).</li> <li><b>Is the voltage greater than 0 volts?</b></li> </ul>	Yes = REPAIR the R/W wire. No = REPLACE the TIM. REFER to Section 303-14.

**PINPOINT TEST B: DTC C1849 MASTER CYLINDER PRESSURE OUT OF RANGE**

<b>TEST STEP</b>	<b>ACTION TO TAKE</b>
<b>B1 CHECK MASTER CYLINDER PRESSURE STATUS</b> <ul style="list-style-type: none"> <li>With key ON, monitor the traction inverter module (TIM) PID MC__PRES while depressing the brake pedal.</li> <li><b>Does the MC__PRES PID voltage increase from approximately 0.45 to 4.65 volts as the brake pedal is depressed?</b></li> </ul>	Yes = System OK. CHECK wiring for intermittent connections. No = If MC__PRES is between 0.8 and 0.50 volts at all times, GO to <b>B2</b> . If MC__PRES is 0.0 volts at all times, GO to <b>B4</b> .
<b>B2 CHECK CIRCUIT 3600 (R/W) FOR OPEN</b> <ul style="list-style-type: none"> <li>Connect 104-Pin Breakout Box (BOB) to TIM C4998, C4999 using the BCM/TIM BOB Adapter Cable and Overlay; leave the TIM disconnected.</li> <li>With key OFF, disconnect master cylinder brake pressure sensor C1940 and measure the resistance of the R/W wire between master cylinder brake pressure sensor C1940 and BOB pin B22.</li> <li><b>Is the resistance less than 5 ohms?</b></li> </ul>	Yes = GO to <b>B3</b> . No = REPAIR the R/W wire.
<b>B3 CHECK CIRCUIT 3600 (R/W) FOR SHORT TO GROUND</b>	

(Continued)

**DIAGNOSIS AND TESTING (Continued)****PINPOINT TEST B: DTC C1849 MASTER CYLINDER PRESSURE OUT OF RANGE**

TEST STEP	ACTION TO TAKE
<ul style="list-style-type: none"> <li>With key ON, measure the resistance between BOB pin B22 and ground (BOB pin A29).</li> <li><b>Is the resistance greater than 10,000 ohms?</b></li> </ul>	Yes = REPLACE the master cylinder brake pressure sensor. No = REPAIR the R/W wire.
<b>B4 CHECK TIM VOLTAGE REFERENCE TO MASTER CYLINDER BRAKE PRESSURE SENSOR</b> <ul style="list-style-type: none"> <li>With key OFF, disconnect master cylinder brake pressure sensor C1940.</li> <li>With key ON, measure the voltage between the R wire on master cylinder brake pressure sensor C1940 and ground.</li> <li><b>Is the voltage greater than 4.8 volts?</b></li> </ul>	Yes = REPLACE the master cylinder brake pressure sensor. No = GO to <b>B5</b> .
<b>B5 CHECK CIRCUIT 3603 (R) FOR OPEN</b> <ul style="list-style-type: none"> <li>Connect 104-Pin Breakout Box (BOB) to TIM C4998, C4999 using the BCM/TIM BOB Adapter Cable and Overlay; leave the TIM disconnected.</li> <li>With key OFF, measure the resistance of the R wire between master cylinder brake pressure sensor C1940 and BOB pin B23.</li> <li><b>Is the resistance less than 5 ohms?</b></li> </ul>	Yes = GO to <b>B6</b> . No = REPAIR the R wire.
<b>B6 CHECK CIRCUIT 3603 (R) FOR SHORT TO GROUND</b> <ul style="list-style-type: none"> <li>With key OFF, measure the resistance between BOB pin B23 and ground (BOB pin A29).</li> <li><b>Is the resistance greater than 10,000 ohms?</b></li> </ul>	Yes = REPLACE the TIM. REFER to Section 303-14. No = REPAIR the R wire.

**Traction Battery Charging/Heating System****Diagnostic Trouble Code (DTC) Definition**

The following DTCs relate to the traction battery charging/heating system:

- DTC C1836 Battery Temperature Out of Range
  - The battery control module (BCM) uses four temperature sensors to monitor the temperature of the traction battery. The normal range of the temperature sensors is between 430 and 280,000 ohms. The BCM sets DTC C1836 if it detects any of the temperature sensor readings out of range. The BCM uses PIDs to indicate the temperature sensor that is out of range.

**DIAGNOSIS AND TESTING (Continued)**

- DTC C1838 Charging System Fault

- The battery control module (BCM) sets DTC C1838 when a failure occurs in the traction battery charging system. The BCM uses PIDs to indicate the charging system failure that occurred. The possible failures are:
  - A charger charging after being disabled fault occurs if the charger charging signal or the auxiliary current sensor indicates that the charger is still outputting significant current several seconds after the BCM has commanded the charger off.
  - A charger overtemperature fault occurs if the charger fault signal is asserted and the charger ready signal is deasserted during a charge cycle.
  - A charger latchup fault occurs if the charger fault signal and charger ready signal are asserted during a charge cycle.
  - A charger cycling fault occurs if the charger is cycled on and off several times within a short period of time due to a reoccurring fault condition. If this occurs, the BCM disables the charger.
  - A charger undercurrent fault occurs if the BCM commands maximum power output from the charger and little or no current is detected at the auxiliary current sensor for an extended period of time. There are several potential causes for this fault.
  - A charger overcurrent fault occurs if the BCM commands zero power output from the charger and significant current is detected at the auxiliary current sensor for an extended period of time.
  - A charger overvoltage fault occurs if the BCM detects the traction battery voltage to be greater than 385 volts during a charge cycle. If this occurs, the BCM disables the charger.
  - A charger over amp-hours fault occurs the BCM detects that more than 105 amp-hours of current have been put into the traction battery during the charge cycle. If this occurs, the BCM disables the charger.
  - A charger line capacity fault occurs if the BCM commands maximum power output from the charger and little or no current is detected at the auxiliary current sensor for an extended period of time and the charger line capacity

signal indicates zero.

- A charger mode fault occurs if the BCM detects the charger mode signal is not being pulled up to auxiliary battery voltage by the charger. If this occurs, the BCM does not enable the charger.
  - An independent observer module (IOM) to BCM diagnostic signal stuck low fault occurs when the IOM to BCM diagnostic input is shorted to ground or if the BCM to IOM diagnostic output is open.
  - An independent observer module (IOM) to BCM diagnostic signal stuck high fault occurs if any of the following occur: IOM is disconnected, the IOM to BCM diagnostic input is open, the BCM to IOM diagnostic output is shorted to ground, or there is an IOM diagnostic fault due to an IOM battery temperature sensor is out of range or the IOM has detected a high/rapid change in battery temperature.
- DTC C1859 PRNDL Input #2 Circuit Failure
    - The battery control module (BCM) sets DTC C1859 during the BCM on-demand self test if it detects the PRNDE TR2 signal is not grounded. An open or short in the TR2 signal wire or the gear selector not in the PARK position during the on-demand self-test will cause DTC C1859.
  - DTC C1861 PRNDL Input #4 Circuit Failure
    - The battery control module (BCM) sets DTC C1861 during the BCM on-demand self test if it detects the PRNDE TR4 signal is not grounded. An open or short in the TR4 signal wire or the gear selector not in the PARK position during the on-demand self-test will cause DTC C1861.
  - DTC C1863 External Charging Fault
    - The battery control module (BCM) sets DTC C1863 if the on-plug circuit indicates the vehicle is plugged into a power control station (PCS) and the traction inverter module (TIM) indicates the vehicle is traveling faster than 15 km/h (9.4 mph).

**Electrical Schematic**

Refer to Electrical and Vacuum Troubleshooting Manual, Cell 18, Traction Battery Charging/Heating System for schematic and connector information.

**DIAGNOSIS AND TESTING (Continued)****Inspection and Verification**

Refer to [Section 100-07](#).

**Symptom Chart****Symptom Chart**

<b>Condition</b>	<b>Possible Sources</b>	<b>Action</b>
<ul style="list-style-type: none"> <li>DTC C1836 Battery Temperature Out of Range</li> </ul>	<ul style="list-style-type: none"> <li>Circuit(s).</li> <li>Battery temperature sensor.</li> <li>Battery control module (BCM).</li> </ul>	<ul style="list-style-type: none"> <li>GO to Pinpoint Test A.</li> </ul>
<ul style="list-style-type: none"> <li>DTC C1838 Charging System Fault</li> </ul>	<ul style="list-style-type: none"> <li>Charger charging after being disabled fault.</li> <li>Charger over-temperature fault.</li> <li>Charger latchup fault.</li> <li>Charger cycling fault.</li> <li>Charger under current fault.</li> <li>Charger over current fault.</li> <li>Charger over voltage fault.</li> <li>Charger over amp-hours fault.</li> <li>Charger line capacity fault.</li> <li>Charger mode feedback fault.</li> <li>IOM to BCM diagnostic input stuck high fault.</li> <li>IOM to BCM diagnostic input stuck low fault.</li> </ul>	<ul style="list-style-type: none"> <li>GO to Pinpoint Test C.</li> </ul>
<ul style="list-style-type: none"> <li>Charger Charging After Being Disabled Fault</li> </ul>	<ul style="list-style-type: none"> <li>Contactor box.</li> <li>Circuit(s).</li> <li>Traction battery charger.</li> <li>Battery control module (BCM).</li> </ul>	<ul style="list-style-type: none"> <li>GO to Pinpoint Test D.</li> </ul>
<ul style="list-style-type: none"> <li>Charger Latchup Fault</li> </ul>	<ul style="list-style-type: none"> <li>Circuit(s).</li> <li>Traction battery charger.</li> <li>Battery control module (BCM).</li> </ul>	<ul style="list-style-type: none"> <li>GO to Pinpoint Test F.</li> </ul>
<ul style="list-style-type: none"> <li>Charger Cycling Fault</li> </ul>	<ul style="list-style-type: none"> <li>Current leakage condition.</li> <li>Traction battery charger.</li> </ul>	<ul style="list-style-type: none"> <li>GO to Pinpoint Test G.</li> </ul>
<ul style="list-style-type: none"> <li>Charger Under Current Fault</li> </ul>	<ul style="list-style-type: none"> <li>High voltage power distribution box (HVPDB).</li> <li>High-voltage harness (14B326).</li> <li>Contactor box high-voltage fuse.</li> <li>Contactor box.</li> <li>Battery control module (BCM).</li> <li>Circuit(s).</li> <li>Traction battery charger.</li> </ul>	<ul style="list-style-type: none"> <li>GO to Pinpoint Test H.</li> </ul>
<ul style="list-style-type: none"> <li>Charger Over Current Fault</li> </ul>	<ul style="list-style-type: none"> <li>Traction battery charger.</li> <li>Contactor box.</li> <li>Battery control module (BCM).</li> </ul>	<ul style="list-style-type: none"> <li>GO to Pinpoint Test J.</li> </ul>

**DIAGNOSIS AND TESTING (Continued)****Symptom Chart (Continued)**

<b>Condition</b>	<b>Possible Sources</b>	<b>Action</b>
<ul style="list-style-type: none"> <li>Charger Over Voltage Fault</li> </ul>	<ul style="list-style-type: none"> <li>High-voltage harness (14A280-NC).</li> <li>High-voltage harness (14A280-AB).</li> <li>Battery control module (BCM).</li> </ul>	<ul style="list-style-type: none"> <li>GO to Pinpoint Test K.</li> </ul>
<ul style="list-style-type: none"> <li>Charger Over Amp-Hours Fault</li> </ul>	<ul style="list-style-type: none"> <li>Traction battery module(s).</li> <li>Traction battery charger.</li> </ul>	<ul style="list-style-type: none"> <li>GO to Pinpoint Test L.</li> </ul>
<ul style="list-style-type: none"> <li>Charger Line Capacity Fault</li> </ul>	<ul style="list-style-type: none"> <li>Power control station (PCS).</li> <li>Traction battery charger.</li> </ul>	<ul style="list-style-type: none"> <li>GO to Pinpoint Test M.</li> </ul>
<ul style="list-style-type: none"> <li>Charger Mode Feedback Fault</li> </ul>	<ul style="list-style-type: none"> <li>Circuit(s).</li> <li>Traction battery charger.</li> <li>Battery control module (BCM).</li> </ul>	<ul style="list-style-type: none"> <li>GO to Pinpoint Test N.</li> </ul>
<ul style="list-style-type: none"> <li>IOM to BCM Diagnostic Input Stuck High Fault</li> </ul>	<ul style="list-style-type: none"> <li>Circuit(s).</li> <li>IOM battery temperature sensors.</li> <li>Independent observer module (IOM).</li> <li>Battery module(s).</li> <li>Battery control module (BCM).</li> </ul>	<ul style="list-style-type: none"> <li>GO to Pinpoint Test P.</li> </ul>
<ul style="list-style-type: none"> <li>IOM to BCM Diagnostic Input Stuck Low Fault</li> </ul>	<ul style="list-style-type: none"> <li>Circuit(s).</li> <li>Independent observer module (IOM).</li> </ul>	<ul style="list-style-type: none"> <li>GO to Pinpoint Test Q.</li> </ul>
<ul style="list-style-type: none"> <li>DTC C1859 PRNDL Input #2 Circuit Failure</li> </ul>	<ul style="list-style-type: none"> <li>Circuit(s).</li> <li>Battery control module (BCM).</li> </ul>	<ul style="list-style-type: none"> <li>GO to Pinpoint Test R.</li> </ul>
<ul style="list-style-type: none"> <li>DTC C1861 PRNDL Input #4 Circuit Failure</li> </ul>	<ul style="list-style-type: none"> <li>Circuit(s).</li> <li>Battery control module (BCM).</li> </ul>	<ul style="list-style-type: none"> <li>GO to Pinpoint Test S.</li> </ul>
<ul style="list-style-type: none"> <li>DTC C1863 External Charging Fault</li> </ul>	<ul style="list-style-type: none"> <li>Circuit(s).</li> <li>Charger inlet assembly.</li> <li>Battery control module (BCM).</li> </ul>	<ul style="list-style-type: none"> <li>GO to Pinpoint Test T.</li> </ul>
<ul style="list-style-type: none"> <li>Power Control Station (PCS) Operation Verification Test</li> </ul>	<ul style="list-style-type: none"> <li>Improper PCS connection to charger inlet.</li> <li>PCS.</li> <li>Vehicle charging system failure.</li> </ul>	<ul style="list-style-type: none"> <li>GO to Pinpoint Test U.</li> </ul>

**Pinpoint Tests****Special Tool(s)**

104-Pin Breakout Box (BOB) 418-049 (014-00950) or equivalent
BCM/TIM Breakout Box (BOB) Adapter Cable 418-F212
BCM/TIM Breakout Box (BOB) Overlay 418-F220

(Continued)

**Special Tool(s)**

Traction Battery High-Voltage Service Cord 418-F218
Traction Battery Low-Voltage Service Cord 418-F219
Traction Battery High-Voltage Lockout and Diagnostic Tool 418-F207
High-Voltage Insulated Safety Gloves 100-F036 or equivalent
Face Shield 100-F035 or equivalent

**DIAGNOSIS AND TESTING (Continued)****PINPOINT TEST A: DTC C1836 BATTERY TEMPERATURE OUT OF RANGE**

TEST STEP	ACTION TO TAKE
<p><b>A1 CHECK FOR BATTERY TEMPERATURE SENSOR OUT OF RANGE FAULT</b></p> <ul style="list-style-type: none"> <li>With key ON, monitor battery control module (BCM) PIDs BATTMP1, BATTMP2, BATTMP3, and BATTMP4.</li> <li>Do any of the BATTMP PIDs indicate YES?</li> </ul>	<p>Yes = GO to <b>A2</b>.</p> <p>No = System OK. If DTC C1836 reoccurs intermittently, GO to <b>A6</b>.</p>
<p><b>A2 CHECK WIRES TO BATTERY TEMPERATURE SENSOR FOR OPEN(S)</b></p> <ul style="list-style-type: none"> <li>Remove the traction battery and connect Traction Battery High-Voltage Lockout and Diagnostic Tool to the traction battery high-voltage two-pin C3994M.</li> </ul> <p><b>⚠ WARNING: The traction battery contains high-voltage components and wiring. High-voltage insulated safety gloves and face shield must be worn when carrying out the following steps. Failure to follow this warning may result in severe personal injury or death.</b></p> <ul style="list-style-type: none"> <li>Connect 104-Pin Breakout Box (BOB) to BCM C1986, C1987 using the BCM/TIM BOB Adapter Cable and Overlay; leave the BCM disconnected.</li> <li>Measure the resistance of the wires indicated below for the battery temperature sensor in question.</li> </ul> <p><b>Battery Temperature Sensor #1:</b></p> <ul style="list-style-type: none"> <li>With key OFF, disconnect battery temperature sensor #1 C1813 and measure the resistance of the BR wire between BOB pin A40 and temperature sensor #1 C1813.</li> <li>With key OFF, measure the resistance of the BR/W wire between BOB pin A9 and temperature sensor #1 C1813.</li> </ul> <p><b>Battery Temperature Sensor #2:</b></p> <ul style="list-style-type: none"> <li>With key OFF, disconnect battery temperature sensor #2 C1814 and measure the resistance of the GY/BK wire between BOB pin A21 and temperature sensor #2 C1814.</li> <li>With key OFF, measure the resistance of the DG wire between BOB pin A22 and temperature sensor #2 C1814.</li> </ul> <p><b>Battery Temperature Sensor #3:</b></p> <ul style="list-style-type: none"> <li>With key OFF, disconnect battery temperature sensor #3 C1815 and measure the resistance of the LG/BK wire between BOB pin A24 and temperature sensor #3 C1815.</li> <li>With key OFF, measure the resistance of the R/W wire between BOB pin A25 and temperature sensor #3 C1815.</li> </ul> <p><b>Battery Temperature Sensor #4:</b></p> <ul style="list-style-type: none"> <li>With key OFF, disconnect battery temperature sensor #4 C1816 and measure the resistance of the BK/LB wire between BOB pin A26 and temperature sensor #4 C1816.</li> <li>With key OFF, measure the resistance of the O/R wire between BOB pin A27 and temperature sensor #4 C1816.</li> </ul> <p><b>Are the resistances less than 5 ohms?</b></p>	<p>Yes = GO to <b>A3</b>.</p> <p>No = REPAIR the wire(s) in question.</p>
<p><b>A3 CHECK SIGNAL WIRE TO BATTERY TEMPERATURE SENSOR FOR SHORT TO GROUND</b></p> <ul style="list-style-type: none"> <li>With key OFF, measure the resistance between the BOB pins indicated below for the battery temperature sensor in question.</li> </ul>	<p>Yes = GO to <b>A4</b>.</p>

(Continued)

**DIAGNOSIS AND TESTING (Continued)****PINPOINT TEST A: DTC C1836 BATTERY TEMPERATURE OUT OF RANGE**

TEST STEP	ACTION TO TAKE
<p><b>Battery Temperature Sensor #1</b> —BOB pins A9 and A33</p> <p><b>Battery Temperature Sensor #2</b> —BOB pins A22 and A33</p> <p><b>Battery Temperature Sensor #3</b> —BOB pins A25 and A33</p> <p><b>Battery Temperature Sensor #4</b> —BOB pins A27 and A33</p> <p>• <b>Is the resistance greater than 10,000 ohms?</b></p>	<p>No = REPAIR the BR/W wire (#1), DG wire (#2), R/W wire (#3), or O/R wire (#4).</p>
<p><b>A4 CHECK SIGNAL WIRE TO BATTERY TEMPERATURE SENSOR FOR SHORT TO POWER</b></p> <ul style="list-style-type: none"> <li>• Connect Traction Battery Low-Voltage Service Cord to traction battery support tray in-line C1939F and in-line C1939M.</li> <li>• With key OFF, disconnect high-voltage auxiliary load in-line C1935 from the traction battery support tray and connect Traction Battery high-voltage Service Cord to traction battery support tray in-line C1935F and in-line C1935M.</li> <li>• With key ON, measure the voltage between the BOB pins indicated below for the battery temperature sensor in question.</li> </ul> <p><b>Battery Temperature Sensor #1</b> —BOB pins A9 and A33</p> <p><b>Battery Temperature Sensor #2</b> —BOB pins A22 and A33</p> <p><b>Battery Temperature Sensor #3</b> —BOB pins A25 and A33</p> <p><b>Battery Temperature Sensor #4</b> —BOB pins A27 and A33</p> <p>• <b>Is the voltage greater than 0 volts?</b></p>	<p>Yes = REPAIR the BR/W wire (#1), DG wire (#2), R/W wire (#3), or O/R wire (#4).</p> <p>No = GO to A5.</p>
<p><b>A5 CHECK BATTERY TEMPERATURE SENSOR</b></p> <ul style="list-style-type: none"> <li>• With key OFF, measure the resistance between the terminals of the battery temperature sensor in question.</li> </ul> <p>• <b>Is the resistance between 430 and 280,000 ohms?</b></p>	<p>Yes = REPLACE the BCM.</p> <p>No = REPLACE the battery temperature sensor.</p>
<p><b>A6 CHECK WIRING FOR INTERMITTENT CONNECTIONS</b></p> <ul style="list-style-type: none"> <li>• Remove the traction battery and connect Traction Battery High-Voltage Lockout and Diagnostic Tool to the traction battery high-voltage two-pin C3994M.</li> <li>• Connect Traction Battery Low-Voltage Service Cord to traction battery support tray in-line C1939F and in-line C1939M.</li> <li>• Connect Traction Battery High-Voltage Service Cord to traction battery support tray in-line C1935F and in-line C1935M.</li> <li>• Clear the BCM DTCs.</li> <li>• With key ON, monitor BCM PID BATTMP for the battery temperature sensor in question.</li> <li>• Exercise (wiggle) the wiring harness to the battery temperature sensor.</li> </ul> <p>• <b>Does the BATTMP PID indicate YES?</b></p>	<p>Yes = REPAIR the wire(s) for intermittent connections.</p> <p>No = System OK. If DTC C1836 keeps occurring, REPLACE the BCM.</p>



**DIAGNOSIS AND TESTING (Continued)****PINPOINT TEST C: DTC C1838 CHARGER SYSTEM FAULT**

TEST STEP	ACTION TO TAKE
<p><b>C1 CHECK FOR CHARGING SYSTEM FAULT</b></p> <p><b>NOTE:</b> Clear the diagnostic trouble codes (DTCs) from the battery control module (BCM) continuous memory before connecting the vehicle to a power control station (PCS). The vehicle may need to be left on charge for up to five minutes to set a charging system fault (DTC C1838).</p> <ul style="list-style-type: none"> <li>Connect the vehicle to the PCS and press the START button to begin charging.</li> <li>Wait approximately five minutes and retrieve continuous DTCs from the BCM.</li> <li><b>Does DTC C1838 Charging System Fault occur?</b></li> </ul>	<p>Yes = GO to <b>C2</b>.</p> <p>No = System OK.</p>
<p><b>C2 IDENTIFY CHARGING SYSTEM FAULT</b></p> <ul style="list-style-type: none"> <li>With vehicle on-charge, monitor the following BCM PIDs:</li> </ul> <p><b>Charging System Fault PID/Description</b></p> <ul style="list-style-type: none"> <li>—CHG __ABD = Charger Charging After Being Disabled</li> <li>—CHG __CYF = Charger Cycling Fault</li> <li>—CHG __LCF = Charger Line Capacity Fault</li> <li>—CHG __LUF = Charger Latchup Fault</li> <li>—CHG __MFF = Charger Mode Feedback Fault</li> <li>—CHG __OAF = Charger Over Amp-Hours Fault</li> <li>—CHG __OCF = Charger Over Current Fault</li> <li>—CHG __OTF = Charger Over-Temperature Fault</li> <li>—CHG __OVF = Charger Over Voltage Fault</li> <li>—CHG __UCF = Charger Under Current Fault</li> <li>—IOMH __F = IOM to BCM Diagnostic Input Stuck High Fault</li> <li>—IOML __F = IOM to BCM Diagnostic Input Stuck Low Fault</li> </ul> <ul style="list-style-type: none"> <li><b>Do any of the charging system fault PIDs indicate YES?</b></li> </ul>	<p>Yes = REFER to Symptom Chart.</p> <p>No = REPEAT test step C1. IF DTC C1838 does not occur, system OK. CHECK wiring for intermittent connections.</p>

**PINPOINT TEST D: CHARGER CHARGING AFTER BEING DISABLED FAULT**

TEST STEP	ACTION TO TAKE
<p><b>D1 CHECK CHARGER CHARGING AFTER BEING DISABLED STATUS</b></p> <ul style="list-style-type: none"> <li>Verify the vehicle is connected to the power control station (PCS) and the START button has been depressed to begin charging.</li> </ul> <p><b>NOTE:</b> Wait approximately up to five minutes to allow the CHG__ABD PID to be set.</p> <ul style="list-style-type: none"> <li>With key OFF and vehicle on-charge, monitor BCM PID CHG__ABD.</li> <li><b>Does the CHG__ABD PID indicate YES?</b></li> </ul>	<p>Yes = DISCONNECT the PCS from the vehicle. GO to <b>D2</b>.</p> <p>No = System OK. CHECK wiring for intermittent connections.</p>
<p><b>D2 CHECK CONTACTOR BOX AUXILIARY CURRENT SENSOR FOR IN-RANGE FAILURE</b></p> <ul style="list-style-type: none"> <li>With key ON, monitor BCM PID AUX__CNT.</li> <li>Turn the headlamps on.</li> <li><b>Does the amperage for the AUX__CNT PID increase by at least 0.5 amps?</b></li> </ul>	<p>Yes = GO to <b>D3</b>.</p> <p>No = REPLACE the contactor box.</p>
<p><b>D3 CHECK CIRCUIT 3827 (GY/W) (OUTSIDE OF TRACTION BATTERY SUPPORT TRAY) FOR OPEN</b></p>	

(Continued)

**DIAGNOSIS AND TESTING (Continued)****PINPOINT TEST D: CHARGER CHARGING AFTER BEING DISABLED FAULT**

<b>TEST STEP</b>	<b>ACTION TO TAKE</b>
<ul style="list-style-type: none"> <li>With key OFF, disconnect traction battery support tray in-line C1939 and connect 104-Pin Breakout Box (BOB) to in-line C1939M using Traction Battery Low-Voltage Service Cord; do not connect Traction Battery Low-Voltage Service Cord to in-line C1939F.</li> <li>With key OFF, disconnect traction battery charger C1991 and measure the resistance of the GY/W wire between pin 4 on traction battery charger C1991 and BOB pin 57.</li> <li><b>Is the resistance less than 5 ohms?</b></li> </ul>	<p>Yes = GO to <b>D4</b>.</p> <p>No = REPAIR the GY/W wire.</p>
<p><b>D4 CHECK CIRCUIT 3827 (GY/W) (OUTSIDE OF TRACTION BATTERY SUPPORT TRAY) FOR SHORT TO GROUND</b></p> <ul style="list-style-type: none"> <li>With key OFF, measure the resistance between BOB pin 57 and ground (BOB pin 65).</li> <li><b>Is the resistance greater than 10,000 ohms?</b></li> </ul>	<p>Yes = GO to <b>D5</b>.</p> <p>No = REPAIR the GY/W wire.</p>
<p><b>D5 CHECK CIRCUIT 3827 (GY/W) (INSIDE OF TRACTION BATTERY SUPPORT TRAY) FOR OPEN</b></p> <ul style="list-style-type: none"> <li>Disconnect the BOB from in-line C1939M, remove the traction battery, and connect Traction Battery High-Voltage Lockout and Diagnostic Tool to the traction battery high-voltage two-pin C3994M.</li> </ul> <p><b>⚠ WARNING: The traction battery contains high-voltage components and wiring. High-voltage insulated safety gloves and face shield must be worn when carrying out the following steps. Failure to follow this warning may result in severe personal injury or death.</b></p> <ul style="list-style-type: none"> <li>Connect 104-Pin Breakout Box (BOB) to traction battery support tray in-line C1939F using Traction Battery Low-Voltage Service Cord; do not connect Traction Battery Low-Voltage Service Cord to in-line C1939M.</li> <li>With key OFF, disconnect BCM C1986 and measure the resistance of the GY/W wire between pin 8 on BCM C1986 and BOB pin 57.</li> <li><b>Is the resistance less than 5 ohms?</b></li> </ul>	<p>Yes = GO to <b>D6</b>.</p> <p>No = REPAIR the GY/W wire.</p>
<p><b>D6 CHECK CIRCUIT 3827 (GY/W) (INSIDE OF TRACTION BATTERY SUPPORT TRAY) FOR SHORT TO GROUND</b></p> <ul style="list-style-type: none"> <li>With key OFF, measure the resistance between BOB pin 57 and ground (BOB pin 65).</li> <li><b>Is the resistance greater than 10,000 ohms?</b></li> </ul>	<p>Yes = REPLACE the traction battery charger.</p> <p>No = REPAIR the GY/W wire.</p>

**PINPOINT TEST F: CHARGER LATCHUP FAULT**

<b>TEST STEP</b>	<b>ACTION TO TAKE</b>
<p><b>F1 CHECK CHARGER OVER-TEMPERATURE STATUS</b></p> <ul style="list-style-type: none"> <li>Verify the vehicle is connected to the power control station (PCS) and the START button has been depressed to begin charging.</li> </ul> <p><b>NOTE:</b> Wait approximately five minutes to allow the CHG__OTF PID to be set.</p> <ul style="list-style-type: none"> <li>With key OFF and vehicle on-charge, monitor BCM PID CHG__OTF.</li> <li><b>Does the CHG__OTF PID indicate YES?</b></li> </ul>	<p>Yes = GO to Pinpoint Test E.</p> <p>No = DISCONNECT the PCS from the vehicle. GO to <b>F2</b>.</p>
<p><b>F2 CHECK CIRCUIT 3800 (LG/BK) (OUTSIDE OF TRACTION BATTERY SUPPORT TRAY) FOR OPEN</b></p> <ul style="list-style-type: none"> <li>With key OFF, disconnect traction battery support tray in-line C1939 and connect 104-Pin Breakout Box (BOB) to in-line C1939M using Traction Battery Low-Voltage Service Cord; do not connect Traction Battery Low-Voltage Service Cord to in-line C1939F.</li> </ul>	<p>Yes = GO to <b>F3</b>.</p>

(Continued)

**DIAGNOSIS AND TESTING (Continued)****PINPOINT TEST F: CHARGER LATCHUP FAULT**

<b>TEST STEP</b>	<b>ACTION TO TAKE</b>
<ul style="list-style-type: none"> <li>With key OFF, disconnect traction battery charger C1991 and measure the resistance of the LG/BK wire between pin 2 on traction battery charger C1991 and BOB pin 55.</li> <li><b>Is the resistance less than 5 ohms?</b></li> </ul>	No = REPAIR the LG/BK wire.
<b>F3 CHECK CIRCUIT 3800 (LG/BK) (OUTSIDE OF TRACTION BATTERY SUPPORT TRAY) FOR SHORT TO GROUND</b> <ul style="list-style-type: none"> <li>With key OFF, measure the resistance between BOB pin 55 and ground (BOB pin 65).</li> <li><b>Is the resistance greater than 10,000 ohms?</b></li> </ul>	Yes = GO to <b>F4</b> . No = REPAIR the LG/BK wire.
<b>F4 CHECK CIRCUIT 3800 (LG/BK) (INSIDE OF TRACTION BATTERY SUPPORT TRAY) FOR OPEN</b> <ul style="list-style-type: none"> <li>Disconnect the BOB from in-line C1939M, remove the traction battery, and connect Traction Battery High-Voltage Lockout and Diagnostic Tool to the traction battery high-voltage two-pin C3994M.</li> </ul> <p> <b>WARNING: The traction battery contains high-voltage components and wiring. High-voltage insulated safety gloves and face shield must be worn when carrying out the following steps. Failure to follow this warning may result in severe personal injury or death.</b></p> <ul style="list-style-type: none"> <li>Connect 104-Pin Breakout Box (BOB) to traction battery support tray in-line C1939F using Traction Battery Low-Voltage Service Cord; do not connect Traction Battery Low-Voltage Service Cord to in-line C1939M.</li> <li>With key OFF, disconnect BCM C1987 and measure the resistance of the LG/BK wire between pin 14 on BCM C1987 and BOB pin 55.</li> <li><b>Is the resistance less than 5 ohms?</b></li> </ul>	Yes = GO to <b>F5</b> . No = REPAIR the LG/BK wire.
<b>F5 CHECK CIRCUIT 3800 (LG/BK) (INSIDE OF TRACTION BATTERY SUPPORT TRAY) FOR SHORT TO GROUND</b> <ul style="list-style-type: none"> <li>With key OFF, measure the resistance between BOB pin 55 and ground (BOB pin 65).</li> <li><b>Is the resistance greater than 10,000 ohms?</b></li> </ul>	Yes = REPLACE the traction battery charger. No = REPAIR the LG/BK wire.

**PINPOINT TEST G: CHARGER CYCLING FAULT**

<b>TEST STEP</b>	<b>ACTION TO TAKE</b>
<b>G1 CHECK FOR OTHER BATTERY CONTROL MODULE (BCM) DIAGNOSTIC TROUBLE CODES (DTCs)</b> <p><b>NOTE:</b> If vehicle was recently in a hot temperature environment, allow vehicle to cool down before proceeding.</p> <ul style="list-style-type: none"> <li>Connect the vehicle to a power control station (PCS) and press the START button to begin charging.</li> <li>Wait approximately five minutes and retrieve continuous DTCs from the BCM.</li> <li><b>Does DTC C1839 Leakage Fault occur along with DTC C1838 Charging System Fault?</b></li> </ul>	Yes = REFER to Current Leakage Detection in this section. No = If DTC C1838 does not occur, system OK. If DTC C1838 does occur, GO to Pinpoint Test C and REPEAT. If other charging system faults are indicated in Pinpoint Test C, PERFORM the diagnostic procedure for the other faults. If no other charging system faults occur, REPLACE the traction battery charger.

**DIAGNOSIS AND TESTING (Continued)****PINPOINT TEST H: CHARGER UNDER CURRENT FAULT**

TEST STEP	ACTION TO TAKE
<b>H1 CHECK CONTACTOR BOX AUXILIARY CURRENT SENSOR FOR IN-RANGE FAILURE</b> <ul style="list-style-type: none"> <li>• With key ON, monitor battery control module (BCM) PID AUX__CNT.</li> <li>• Turn the A/C on and turn the steering wheel back and forth.</li> <li>• <b>Does the amperage for the AUX__CNT PID increase and decrease?</b></li> </ul>	Yes = GO to <b>H2</b> . No = REPLACE the contactor box.
<b>H2 CHECK CHARGER CONTACTOR RELAY OUTPUT CIRCUIT</b> <ul style="list-style-type: none"> <li>• Disconnect the 12-volt auxiliary battery negative cable and remove the high-voltage power distribution box (HVPDB) cover.</li> </ul> <p> <b>WARNING: The following test steps contain high-voltage procedures. High-voltage insulated safety gloves and face shield must be worn when carrying out the following steps. Failure to follow this warning may result in severe personal injury or death.</b></p> <ul style="list-style-type: none"> <li>• Disconnect HVPDB traction battery charger high-voltage C1923.</li> <li>• Reinstall the HVPDB cover.</li> <li>• Reconnect the 12-volt auxiliary battery negative cable.</li> <li>• Enter battery control module (BCM) active command mode CONTACTOR OUTPUT CONTROL and set active command CHARGER to CLOSE.</li> <li>• With key ON, measure the voltage between circuit 3170 (O wire) and circuit 3171 (W wire) on HVPDB traction battery charger high-voltage C1923F.</li> <li>• <b>Is the voltage greater than 300 volts?</b></li> </ul>	Yes = GO to <b>H10</b> .  No = GO to <b>H3</b> .
<b>H3 CHECK HVPDB CIRCUITS 3134 (O) AND 3133 (W) (OUTSIDE OF TRACTION BATTERY SUPPORT TRAY) FOR OPEN(S)</b> <ul style="list-style-type: none"> <li>• With key OFF, disconnect high-voltage auxiliary load in-line C1935 on the traction battery support tray and measure the resistance between circuit 3170 (O wire) on HVPDB traction battery charger high-voltage C1923F and circuit 3134 (O wire) on in-line C1935M.</li> <li>• With key OFF, measure the resistance between circuit 3171 (W wire) on HVPDB traction battery charger high-voltage C1923 and circuit 3133 (W wire) on in-line C1935M.</li> <li>• <b>Are the resistances less than 5 ohms?</b></li> </ul>	Yes = GO to <b>H4</b> .  No = REPLACE the HVPDB.
<b>H4 CHECK CIRCUITS 3134 (O) AND 3133 (W) (INSIDE TRACTION BATTERY SUPPORT TRAY) FOR OPEN(S)</b> <ul style="list-style-type: none"> <li>• Remove the traction battery and connect Traction Battery High-Voltage Lockout and Diagnostic Tool to the traction battery high-voltage two-pin C3994M.</li> </ul> <p><b>NOTE:</b> Contactor box C3985 is mounted on the passenger side of the BCM.</p> <ul style="list-style-type: none"> <li>• With key OFF, disconnect contactor box C3985 and measure the resistance of the O wire between contactor box C3985F and traction battery support tray in-line C1935F.</li> <li>• With key OFF, measure the resistance of the W wire between contactor box C3985F and traction battery support tray in-line C1935F.</li> <li>• <b>Is the resistance less than 5 ohms?</b></li> </ul>	Yes = GO to <b>H5</b> .  No = REPLACE high-voltage harness (14B326) between traction battery support tray in-line C1935F and contactor box C3985.
<b>H5 CHECK CHARGER CONTACTOR RELAY</b> <ul style="list-style-type: none"> <li>• Reconnect contactor box C3985.</li> </ul>	Yes = GO to <b>H6</b> .

(Continued)

**DIAGNOSIS AND TESTING (Continued)****PINPOINT TEST H: CHARGER UNDER CURRENT FAULT**

<b>TEST STEP</b>	<b>ACTION TO TAKE</b>
<ul style="list-style-type: none"> <li>Connect Traction Battery High-Voltage Service Cord to traction battery support tray in-line C1935F and in-line C1935M.</li> <li>Connect Traction Battery Low-Voltage Service Cord to traction battery support tray in-line C1939F and in-line C1939M.</li> <li>Enter BCM active command mode CONTACTOR OUTPUT CONTROL, set the active command CHARGER to CLOSE, and listen for the charger contactor relay closing.</li> <li><b>Does the charger contactor relay close?</b></li> </ul>	No = GO to <b>H7</b> .
<b>H6 CHECK CONTACTOR BOX HIGH-VOLTAGE FUSE</b> <ul style="list-style-type: none"> <li>Remove the 25A CHARGER fuse from the contactor box. Refer to Contactor Box Fuses Removal and Installation procedure in this section.</li> <li>Measure the resistance of the 25A CHARGER fuse.</li> <li><b>Is the resistance greater than 1,000 ohms?</b></li> </ul>	Yes = REPLACE the 25A CHARGER fuse. No = REPLACE the contactor box.
<b>H7 CHECK CHARGER CONTACTOR RELAY CONTROL (CLOSE SIGNAL)</b> <ul style="list-style-type: none"> <li>Reconnect contactor box C3985.</li> <li>Connect Traction Battery Low-Voltage Service Cord to traction battery support tray in-line C1939F and in-line C1939M.</li> <li>Connect Traction Battery High-Voltage Service Cord to traction battery support tray in-line C1935F and in-line C1935M.</li> <li>Connect 104-Pin Breakout Box (BOB) to BCM and BCM C1986, C1987 using the BCM/TIM BOB Adapter Cable and Overlay.</li> <li>Enter BCM active command mode CONTACTOR OUTPUT CONTROL, set the active command CHARGER to CLOSE, and measure the voltage between BOB pin B9 and ground (BOB pin A33).</li> <li><b>Is the voltage greater than 10 volts?</b></li> </ul>	Yes = GO to <b>H9</b> . No = GO to <b>H8</b> .
<b>H8 CHECK CIRCUIT 3137 (GY/Y) FOR SHORT TO GROUND</b> <ul style="list-style-type: none"> <li>With key OFF, disconnect BOB from BCM; leave BOB connected to BCM C1986 and C1987.</li> <li>With key OFF, disconnect contactor box C1982 and measure the resistance between BOB pin B9 and ground (BOB pin A33).</li> <li><b>Is the resistance greater than 10,000 ohms?</b></li> </ul>	Yes = REPLACE the BCM. No = REPAIR the GY/Y wire.
<b>H9 CHECK CIRCUIT 3137 (GY/Y) FOR OPEN</b> <ul style="list-style-type: none"> <li>With key OFF, disconnect contactor box C1982 and measure the resistance of the GY/Y wire between pin 20 on contactor box C1982 and BOB pin B9.</li> <li><b>Is the resistance less than 5 ohms?</b></li> </ul>	Yes = REPLACE the contactor box. No = REPAIR the GY/Y wire.
<b>H10 CHECK OUTPUT OF TRACTION BATTERY CHARGER</b> <ul style="list-style-type: none"> <li>Connect the power control station (PCS) to the charger inlet connector and press the START button on the PCS.</li> </ul> <p><b>NOTE:</b> Measure the voltage immediately after pressing the START button on the PCS. If no voltage output, monitor the voltage for approximately 2 minutes.</p> <ul style="list-style-type: none"> <li>With vehicle on-charge, measure the voltage between circuit 3170 (O wire) and circuit 3171 (W wire) on HVPDB traction battery charger high-voltage C1923M.</li> <li><b>Is the voltage greater than 200 volts?</b></li> </ul>	Yes = GO to <b>H11</b> . No = GO to <b>H12</b> .
<b>H11 CHECK CHARGER OVER-TEMPERATURE FAULT STATUS</b> <ul style="list-style-type: none"> <li>With key OFF, reconnect HVPDB traction battery charger high-voltage C1923.</li> </ul>	Yes = GO to Pinpoint Test E.

(Continued)

**DIAGNOSIS AND TESTING (Continued)****PINPOINT TEST H: CHARGER UNDER CURRENT FAULT**

TEST STEP	ACTION TO TAKE
<ul style="list-style-type: none"> <li>Connect the vehicle to the PCS and press the START button to begin charging.</li> <li>With vehicle on-charge, monitor BCM PID CHG__OTF for approximately five minutes.</li> <li><b>Does the CHG__OTF PID indicate YES?</b></li> </ul>	No = System OK. CHECK wiring for intermittent connections.
<b>H12 CHECK CIRCUITS 3401 (DB/LG) AND 3985 (PK) (OUTSIDE OF TRACTION BATTERY SUPPORT TRAY) FOR OPEN(S)</b> <ul style="list-style-type: none"> <li>With key OFF, disconnect traction battery support tray in-line C1939 and connect 104-Pin Breakout Box (BOB) to in-line C1939M using Traction Battery Low-Voltage Service Cord; do not connect Traction Battery Low-Voltage Service Cord to in-line C1939F.</li> <li>With key OFF, disconnect traction battery charger C1991 and C1993.</li> <li>With key OFF, measure the resistance of the DB/LG wire between pin 3 on traction battery charger C1993 and BOB pin 63.</li> <li>With key OFF, measure the resistance of the PK wire between pin 3 on traction battery charger C1991 and BOB pin 50.</li> <li><b>Are the resistances less than 5 ohms?</b></li> </ul>	Yes = GO to <b>H13</b> .  No = REPAIR the wire(s) in question.
<b>H13 CHECK CIRCUITS 3401 (DB/LG) AND 3985 (PK) (OUTSIDE OF TRACTION BATTERY SUPPORT TRAY) FOR SHORT(S) TO GROUND</b> <ul style="list-style-type: none"> <li>With key OFF, measure the resistance between BOB pins 50, 63 and ground (BOB pin 65).</li> <li><b>Are the resistances greater than 10,000 ohms?</b></li> </ul>	Yes = GO to <b>H14</b> .  No = REPAIR the wire(s) in question.
<b>H14 CHECK CIRCUITS 3401 (DB/LG) AND 3985 (PK) (INSIDE OF TRACTION BATTERY SUPPORT TRAY) FOR OPEN(S)</b> <ul style="list-style-type: none"> <li>Disconnect the BOB from in-line C1939M, remove the traction battery, and connect Traction Battery High-Voltage Lockout and Diagnostic Tool to the traction battery high-voltage two-pin C3994M.</li> <li>Connect 104-Pin Breakout Box (BOB) to traction battery support tray in-line C1939F using Traction Battery Low-Voltage Service Cord; do not connect Traction Battery Low-Voltage Service Cord to in-line C1939M.</li> </ul> <p><b>⚠ WARNING: The traction battery contains high-voltage components and wiring. High-voltage insulated safety gloves and face shield must be worn when carrying out the following steps. Failure to follow this warning may result in severe personal injury or death.</b></p> <ul style="list-style-type: none"> <li>With key OFF, disconnect BCM C1986 and C1987.</li> <li>Measure the resistance of the DB/LG wire between pin 11 on BCM C1986 and BOB pin 63.</li> <li>Measure the resistance of the PK wire between pin 13 on BCM C1986 and BOB pin 50.</li> <li><b>Are the resistances less than 5 ohms?</b></li> </ul>	Yes = GO to <b>H15</b> .  No = REPAIR the wire(s) in question.
<b>H15 CHECK CIRCUITS 3401 (DB/LG) AND 3985 (PK) (INSIDE OF TRACTION BATTERY SUPPORT TRAY) FOR SHORT(S) TO GROUND</b> <ul style="list-style-type: none"> <li>With key OFF, measure the resistance between BOB pins 50, 63 and ground (BOB pin 65).</li> <li><b>Are the resistances greater than 10,000 ohms?</b></li> </ul>	Yes = REPLACE the traction battery charger.  No = REPAIR the wire(s) in question.

**DIAGNOSIS AND TESTING (Continued)****PINPOINT TEST J: CHARGER OVER CURRENT FAULT**

TEST STEP	ACTION TO TAKE
<b>J1 CHECK CONTACTOR BOX AUXILIARY CURRENT SENSOR FOR IN-RANGE FAILURE</b> <ul style="list-style-type: none"> <li>With key ON, monitor BCM PID AUX__CNT.</li> <li>Turn the A/C on and turn the steering wheel back and forth.</li> <li><b>Does the amperage for the AUX__CNT PID increase and decrease?</b></li> </ul>	Yes = REPLACE the traction battery charger. No = GO to <b>J2</b> .
<b>J2 CHECK AUXILIARY CURRENT SENSOR VOLTAGE STATUS</b> <ul style="list-style-type: none"> <li>Remove the traction battery and connect Traction Battery High-Voltage Lockout and Diagnostic Tool to the traction battery high-voltage two-pin C3994M.</li> </ul> <p><b>⚠ WARNING: The traction battery contains high-voltage components and wiring. High-voltage insulated safety gloves and face shield must be worn when carrying out the following steps. Failure to follow this warning may result in severe personal injury or death.</b></p> <ul style="list-style-type: none"> <li>With key OFF, disconnect contactor box C1982.</li> <li>With key ON, monitor BCM PID AUX__SEN.</li> <li><b>Does the AUX__SEN PID indicate greater than 1 volt?</b></li> </ul>	Yes = REPLACE the BCM. No = REPLACE the contactor box.

**PINPOINT TEST K: CHARGER OVER VOLTAGE FAULT**

TEST STEP	ACTION TO TAKE
<b>K1 CHECK TRACTION BATTERY POSITIVE (+) SENSE LINE CIRCUIT BETWEEN IN-LINE C1885F AND BATTERY MODULE 25 FOR SHORTED RESISTOR</b> <ul style="list-style-type: none"> <li>Remove the traction battery and connect Traction Battery High-Voltage Lockout and Diagnostic Tool to the traction battery high-voltage two-pin C3994M.</li> </ul> <p><b>⚠ WARNING: The traction battery contains high-voltage components and wiring. High-voltage insulated safety gloves and face shield must be worn when carrying out the following steps. Failure to follow this warning may result in severe personal injury or death.</b></p> <ul style="list-style-type: none"> <li>With key OFF, disconnect in-line C1885 (label W) and measure the resistance between the LB wire on in-line C1885F and battery module 25 positive (+) post.</li> <li><b>Is the resistance between 28,000 and 34,000 ohms?</b></li> </ul>	Yes = GO to <b>K2</b> . No = REPLACE high-voltage harness (14A280-NC).
<b>K2 CHECK TRACTION BATTERY NEGATIVE (-) SENSE LINE CIRCUIT BETWEEN IN-LINE C1882F AND BATTERY MODULE 1 FOR OPEN</b> <ul style="list-style-type: none"> <li>With key OFF, disconnect in-line C1882 (label R) and measure the resistance between the PK/BK wire on in-line C1882F and battery module 1 positive (+) post.</li> <li><b>Is the resistance between 28,000 and 34,000 ohms?</b></li> </ul>	Yes = REPLACE the BCM. No = REPLACE high-voltage harness (14A280-AB).

**PINPOINT TEST L: CHARGER OVER AMP-HOURS FAULT**

TEST STEP	ACTION TO TAKE
<b>L1 CHECK STATUS OF TRACTION BATTERY MODULES BY CARRYING OUT THE BATTERY MODULE DIAGNOSTIC TEST</b> <ul style="list-style-type: none"> <li>With key ON, carry out the Battery Module Diagnostic Test. Refer to the procedure in Traction Battery System.</li> </ul>	Yes = GO to <b>L3</b> .

(Continued)

**DIAGNOSIS AND TESTING (Continued)****PINPOINT TEST L: CHARGER OVER AMP-HOURS FAULT**

TEST STEP	ACTION TO TAKE
<ul style="list-style-type: none"> <li>Does the Battery Module Diagnostic Test indicate to replace any battery modules?</li> </ul>	No = GO to L2.
<b>L2 CHECK FOR CHARGING SYSTEM FAULT</b> <ul style="list-style-type: none"> <li>Connect the power control station (PCS) to the vehicle and press the START button to begin charging.</li> <li>Wait approximately five minutes.</li> <li>With key OFF and vehicle on-charge, retrieve continuous DTCs from the BCM.</li> <li>Does DTC C1838 Charging System Fault occur?</li> </ul>	Yes = REPLACE the traction battery charger. No = System OK. CHECK wiring for intermittent connections.
<b>L3 INPUT BATTERY MODULE DATA</b> <ul style="list-style-type: none"> <li>With key ON, monitor BCM PIDs BAT__MC, CHG__CYC, and LOWVOLT and enter the values on the Dealer Battery Return Form that is packaged with the new battery module.</li> <li>Fill out all the required data on the Dealer Battery Return Form and return the form with the damaged battery module.</li> <li>Is the correct data entered on the Dealer Battery Return Form?</li> </ul>	Yes = REPLACE the battery module(s) in question. No = ENTER the indicated data. REPLACE the battery module(s) in question.

**PINPOINT TEST M: CHARGER LINE CAPACITY FAULT**

TEST STEP	ACTION TO TAKE
<b>M1 VERIFY POWER CONTROL STATION (PCS) OPERATION</b> <ul style="list-style-type: none"> <li>Carry out the Power Control Station (PCS) Operation Verification Test. Refer to Pinpoint Test S.</li> <li>Is the PCS OK?</li> </ul>	Yes = GO to M2. No = PERFORM the required action as indicated in Pinpoint Test S.
<b>M2 CHECK FOR CHARGING SYSTEM FAULT</b> <ul style="list-style-type: none"> <li>Connect the power control station (PCS) to the vehicle and the depress the START button to begin charging.</li> <li>Wait approximately five minutes.</li> <li>With key OFF and vehicle on-charge, retrieve continuous DTCs from the BCM.</li> <li>Does DTC C1838 Charging System Fault occur?</li> </ul>	Yes = REPLACE the traction battery charger. No = System OK. CHECK wiring for intermittent connections.

**PINPOINT TEST N: CHARGER MODE FEEDBACK FAULT**

TEST STEP	ACTION TO TAKE
<b>N1 CHECK CHARGER UNDER CURRENT STATUS</b> <ul style="list-style-type: none"> <li>Verify the vehicle is connected to the power control station (PCS) and the START button has been depressed to begin charging.</li> </ul> <p><b>NOTE:</b> Wait approximately one to five minutes to allow the CHG__UCF PID to set.</p> <ul style="list-style-type: none"> <li>With key OFF and vehicle on-charge, monitor BCM PID CHG__UCF.</li> <li>Does the CHG__UCF PID indicate YES?</li> </ul>	Yes = GO to Pinpoint Test H. No = DISCONNECT the PCS from the vehicle. GO to N2.
<b>N2 CHECK POWER SIGNAL TO TRACTION BATTERY CHARGER</b> <ul style="list-style-type: none"> <li>With key OFF, disconnect traction battery charger C1993.</li> <li>With key ON, measure the voltage between pin 1 (W wire) on traction battery charger C1993 and ground.</li> <li>Is the voltage greater than 10 volts?</li> </ul>	Yes = GO to N7. No = GO to N3.
<b>N3 CHECK CIRCUIT 3826 (W) (OUTSIDE OF TRACTION BATTERY SUPPORT TRAY) FOR OPEN</b>	

(Continued)



**DIAGNOSIS AND TESTING (Continued)****PINPOINT TEST N: CHARGER MODE FEEDBACK FAULT**

TEST STEP	ACTION TO TAKE
<ul style="list-style-type: none"> <li>• With key OFF, disconnect traction battery support tray in-line C1939 and connect 104-Pin Breakout Box (BOB) to in-line C1939M using Traction Battery Low-Voltage Service Cord; do not connect Traction Battery Low-Voltage Service Cord to in-line C1939F.</li> <li>• With key OFF, measure the resistance of the W wire between pin 1 on traction battery charger C1993 and BOB pin 38.</li> <li>• <b>Is the resistance less than 5 ohms?</b></li> </ul>	<p>Yes = GO to N4.</p> <p>No = REPAIR the W wire.</p>
<p><b>N4 CHECK CIRCUIT 3826 (W) (OUTSIDE OF TRACTION BATTERY SUPPORT TRAY) FOR SHORT TO GROUND</b></p> <ul style="list-style-type: none"> <li>• With key OFF, measure the resistance between BOB pin 38 and ground (BOB pin 65).</li> <li>• <b>Is the resistance greater than 10,000 ohms?</b></li> </ul>	<p>Yes = GO to N5.</p> <p>No = REPAIR the W wire.</p>
<p><b>N5 CHECK CIRCUIT 3826 (W) (INSIDE OF TRACTION BATTERY SUPPORT TRAY) FOR OPEN</b></p> <ul style="list-style-type: none"> <li>• Disconnect the BOB from in-line C1939M, remove the traction battery, and connect Traction Battery High-Voltage Lockout and Diagnostic Tool to the traction battery high-voltage two-pin C3994M.</li> </ul> <p><b>⚠ WARNING: The traction battery contains high-voltage components and wiring. High-voltage insulated safety gloves and face shield must be worn when carrying out the following steps. Failure to follow this warning may result in severe personal injury or death.</b></p> <ul style="list-style-type: none"> <li>• Connect 104-Pin Breakout Box (BOB) to traction battery support tray in-line C1939F using Traction Battery Low-Voltage Service Cord; do not connect Traction Battery Low-Voltage Service Cord to in-line C1939M.</li> <li>• With key OFF, disconnect BCM C1986 and measure the resistance of the W wire between pin 5 on BCM C1986 and BOB pin 38.</li> <li>• <b>Is the resistance less than 5 ohms?</b></li> </ul>	<p>Yes = GO to N6.</p> <p>No = REPAIR the W wire.</p>
<p><b>N6 CHECK CIRCUIT 3826 (W) (INSIDE OF TRACTION BATTERY SUPPORT TRAY) FOR SHORT TO GROUND</b></p> <ul style="list-style-type: none"> <li>• With key OFF, measure the resistance between BOB pin 38 and ground (BOB pin 65).</li> <li>• <b>Is the resistance greater than 10,000 ohms?</b></li> </ul>	<p>Yes = REPLACE the BCM.</p> <p>No = REPAIR the W wire.</p>
<p><b>N7 CHECK CIRCUIT 3992 (BR/Y) (OUTSIDE OF TRACTION BATTERY SUPPORT TRAY) FOR OPEN</b></p> <ul style="list-style-type: none"> <li>• With key OFF, disconnect traction battery support tray in-line C1939 and connect 104-Pin Breakout Box (BOB) to in-line C1939M using Traction Battery Low-Voltage Service Cord; do not connect Traction Battery Low-Voltage Service Cord to in-line C1939F.</li> <li>• With key OFF, measure the resistance of the BR/Y wire between pin 8 on traction battery charger C1993 and BOB pin 49.</li> <li>• <b>Is the resistance less than 5 ohms?</b></li> </ul>	<p>Yes = GO to N8.</p> <p>No = REPAIR the BR/Y wire.</p>
<p><b>N8 CHECK CIRCUIT 3992 (BR/Y) (OUTSIDE OF TRACTION BATTERY SUPPORT TRAY) FOR SHORT TO GROUND</b></p> <ul style="list-style-type: none"> <li>• With key OFF, measure the resistance between BOB pin 49 and ground (BOB pin 65).</li> <li>• <b>Is the resistance greater than 10,000 ohms?</b></li> </ul>	<p>Yes = GO to N9.</p> <p>No = REPAIR the BR/Y wire.</p>
<p><b>N9 CHECK CIRCUIT 3992 (BR/Y) (INSIDE OF TRACTION BATTERY SUPPORT TRAY) FOR OPEN</b></p> <ul style="list-style-type: none"> <li>• Disconnect the BOB from in-line C1939M, remove the traction battery, and connect Traction Battery High-Voltage Lockout and Diagnostic Tool to the traction battery high-voltage two-pin C3994M.</li> </ul>	<p>Yes = GO to N10.</p>

(Continued)

**DIAGNOSIS AND TESTING (Continued)****PINPOINT TEST N: CHARGER MODE FEEDBACK FAULT**

TEST STEP	ACTION TO TAKE
<p> <b>WARNING:</b> The traction battery contains high-voltage components and wiring. High-voltage insulated safety gloves and face shield must be worn when carrying out the following steps. Failure to follow this warning may result in severe personal injury or death.</p> <ul style="list-style-type: none"> <li>• Connect 104-Pin Breakout Box (BOB) to traction battery support tray in-line C1939F using Traction Battery Low-Voltage Service Cord; do not connect Traction Battery Low-Voltage Service Cord to in-line C1939M.</li> <li>• With key OFF, disconnect BCM C1986 and measure the resistance of the BR/Y wire between pin 7 on BCM C1986 and BOB pin 49.</li> <li>• <b>Is the resistance less than 5 ohms?</b></li> </ul>	<p>No = REPAIR the BR/Y wire.</p>
<p><b>N10 CHECK CIRCUIT 3992 (BR/Y) (INSIDE OF TRACTION BATTERY SUPPORT TRAY) FOR SHORT TO GROUND</b></p> <ul style="list-style-type: none"> <li>• With key OFF, measure the resistance between BOB pin 49 and ground (BOB pin 65).</li> <li>• <b>Is the resistance greater than 10,000 ohms?</b></li> </ul>	<p>Yes = REPLACE the traction battery charger.</p> <p>No = REPAIR the BR/Y wire.</p>

**PINPOINT TEST P: IOM TO BCM DIAGNOSTIC INPUT STUCK HIGH FAULT**

TEST STEP	ACTION TO TAKE
<p><b>P1 CHECK STATUS OF INDEPENDENT OBSERVER MODULE (IOM) DIAGNOSTIC TROUBLE CODE (DTC)</b></p> <p><b>NOTE:</b> If an IOM to BCM Diagnostic Input Stuck High Fault occurs, the 12-volt auxiliary battery negative cable must be disconnected and reconnected (power reset) to clear the latched fault from the BCM after the concern is repaired. If the power reset is not performed, the BCM will not allow charging.</p> <p><b>NOTE:</b> If other BCM DTCs occurred along with DTC C1838 Charging System Fault (IOM to BCM Diagnostic Input Stuck High Fault), carry out the diagnostic procedures for those DTCs before carrying out this pinpoint test. Refer to the BCM DTC Index in Section 100-07.</p> <ul style="list-style-type: none"> <li>• Disconnect and reconnect the 12-volt auxiliary battery negative cable.</li> <li>• Clear the BCM continuous DTCs.</li> <li>• With key OFF, monitor BCM PID IOMH__F.</li> <li>• Connect the vehicle to a power control station (PCS) and press the START button (if necessary) to begin charging.</li> <li>• Wait 30 seconds and retrieve continuous BCM DTCs.</li> <li>• <b>Does the IOMH__F PID indicate YES?</b></li> </ul>	<p>Yes = GO to <b>P2</b>.</p> <p>No = GO to <b>P13</b>.</p>
<p><b>P2 CHECK POWER TO IOM AT TRACTION BATTERY SUPPORT TRAY</b></p> <ul style="list-style-type: none"> <li>• With key OFF, disconnect traction battery support tray in-line C1939 and connect 104-Pin Breakout Box (BOB) to in-line C1939M using Traction Battery Low-Voltage Service Cord; do not connect Traction Battery Low-Voltage Service Cord to in-line C1939F.</li> <li>• With key OFF, measure the voltage between BOB pin 45 and ground (BOB pin 65).</li> <li>• <b>Is the voltage greater than 10 volts?</b></li> </ul>	<p>Yes = GO to <b>P3</b>.</p> <p>No = REPAIR the PK/BK wire between the electric vehicle power distribution box (EVPDB) and in-line C1939M.</p>
<p><b>P3 CHECK POWER TO IOM</b></p> <ul style="list-style-type: none"> <li>• Disconnect the BOB from in-line C1939M, remove the traction battery, and connect Traction Battery High-Voltage Lockout and Diagnostic Tool to the traction battery high-voltage two-pin C3994M.</li> </ul>	<p>Yes = GO to <b>P5</b>.</p>

(Continued)

**DIAGNOSIS AND TESTING (Continued)****PINPOINT TEST P: IOM TO BCM DIAGNOSTIC INPUT STUCK HIGH FAULT**

TEST STEP	ACTION TO TAKE
<p> <b>WARNING: The traction battery contains high-voltage components and wiring. High-voltage insulated safety gloves and face shield must be worn when carrying out the following steps. Failure to follow this warning may result in severe personal injury or death.</b></p> <ul style="list-style-type: none"> <li>• Connect Traction Battery Low-Voltage Service Cord to traction battery support tray in-line C1939F and in-line C1939M.</li> <li>• Connect Traction Battery High-Voltage Service Cord to traction battery support tray in-line C1935F and in-line C1935M.</li> <li>• With key OFF, disconnect IOM C1810 and measure the voltage between pin 29 (PK/BK wire) and pin 16 (BK wire) on IOM C1810.</li> <li>• <b>Is the voltage greater than 10 volts?</b></li> </ul>	<p>No = GO to <b>P4</b>.</p>
<p><b>P4 CHECK GROUND TO IOM</b></p> <ul style="list-style-type: none"> <li>• With key OFF, measure the resistance between pin 16 (BK/W wire) on IOM C1810 and ground (BCM case).</li> <li>• <b>Is the resistance less than 5 ohms?</b></li> </ul>	<p>Yes = REPAIR the PK/BK wire between IOM C1810 and in-line C1939F.</p> <p>No = REPAIR the BK/W wire.</p>
<p><b>P5 CHECK WIRES TO IOM BATTERY TEMPERATURE SENSORS FOR OPEN(S)</b></p> <ul style="list-style-type: none"> <li>• Measure the resistance of the wires indicated below for the IOM battery temperature sensors:</li> </ul> <p><b>IOM Battery Temperature Sensor #1:</b></p> <ul style="list-style-type: none"> <li>• With key OFF, disconnect IOM battery temperature sensor #1 C1803 and measure the resistance of the LB wire between pin 35 on IOM C1810 and temperature sensor #1 C1803.</li> <li>• With key OFF, measure the resistance of the O wire between pin 22 on IOM C1810 and temperature sensor #1 C1803.</li> </ul> <p><b>IOM Battery Temperature Sensor #2:</b></p> <ul style="list-style-type: none"> <li>• With key OFF, disconnect IOM battery temperature sensor #2 C1804 and measure the resistance of the LG wire between pin 36 on IOM C1810 and temperature sensor #2 C1804.</li> <li>• With key OFF, measure the resistance of the W wire between pin 23 on IOM C1810 and temperature sensor #2 C1804.</li> </ul> <p><b>IOM Battery Temperature Sensor #3:</b></p> <ul style="list-style-type: none"> <li>• With key OFF, disconnect IOM battery temperature sensor #3 C1805 and measure the resistance of the P wire between pin 37 on IOM C1810 and temperature sensor #3 C1805.</li> <li>• With key OFF, measure the resistance of the BR wire between pin 24 on IOM C1810 and temperature sensor #3 C1804.</li> <li>• <b>Are the resistances less than 5 ohms?</b></li> </ul>	<p>Yes = GO to <b>P6</b>.</p> <p>No = REPAIR the wire(s) in question.</p>
<p><b>P6 CHECK SIGNAL WIRES TO IOM BATTERY TEMPERATURE SENSORS FOR SHORT(S) TO GROUND</b></p> <ul style="list-style-type: none"> <li>• With key OFF, measure the resistance between the pins on IOM C1810 indicated below for the IOM battery temperature sensor signal wires:</li> </ul> <p><b>IOM Battery Temperature Sensor #1 (LB wire)</b> —pins 35 and 16</p> <p><b>IOM Battery Temperature Sensor #2 (LG wire)</b> —pins 36 and 16</p> <p><b>IOM Battery Temperature Sensor #3 (P wire)</b></p>	<p>Yes = GO to <b>P7</b>.</p> <p>No = REPAIR the wire(s) in question.</p>

(Continued)

**DIAGNOSIS AND TESTING (Continued)****PINPOINT TEST P: IOM TO BCM DIAGNOSTIC INPUT STUCK HIGH FAULT**

TEST STEP	ACTION TO TAKE
<p>—pins 37 and 16</p> <ul style="list-style-type: none"> <li>• Are the resistances greater than 10,000 ohms?</li> </ul>	
<p><b>P7 CHECK SIGNAL WIRES TO IOM BATTERY TEMPERATURE SENSORS FOR SHORT(S) TO POWER</b></p> <ul style="list-style-type: none"> <li>• With key ON, measure the voltage between the pins on IOM C1810 indicated below for the IOM battery temperature sensor signal wires:</li> </ul> <p><b>IOM Battery Temperature Sensor #1 (LB wire)</b> —pins 35 and 16</p> <p><b>IOM Battery Temperature Sensor #2 (LG wire)</b> —pins 36 and 16</p> <p><b>IOM Battery Temperature Sensor #3 (P wire)</b> —pins 37 and 16</p> <ul style="list-style-type: none"> <li>• Are any of the voltages greater than 0 volts?</li> </ul>	<p>Yes = REPAIR the wire(s) in question.</p> <p>No = GO to <b>P8</b>.</p>
<p><b>P8 CHECK IOM BATTERY TEMPERATURE SENSORS</b></p> <ul style="list-style-type: none"> <li>• With key OFF, measure the resistance between the terminals of the IOM battery temperature sensors.</li> <li>• Are the resistances between 430 and 280,000 ohms?</li> </ul>	<p>Yes = GO to <b>P9</b>.</p> <p>No = REPLACE the IOM battery temperature sensor(s) in question.</p>
<p><b>P9 CHECK ON-PLUG DETECT CIRCUIT 3404 (Y) FOR OPEN</b></p> <ul style="list-style-type: none"> <li>• Connect 104-Pin Breakout Box (BOB) to BCM C1986, C1987 using the BCM/TIM BOB Adapter Cable and Overlay; leave the BCM disconnected.</li> <li>• With key OFF, measure the resistance of the Y wire between pin 30 on IOM C1810 and BOB pin B12.</li> <li>• Is the resistance less than 5 ohms?</li> </ul>	<p>Yes = GO to <b>P10</b>.</p> <p>No = REPAIR the Y wire.</p>
<p><b>P10 CHECK IOM TO BCM DIAGNOSTIC INPUT CIRCUIT 4008 (R/BK) FOR OPEN</b></p> <ul style="list-style-type: none"> <li>• With key OFF, measure the resistance of the R/BK wire between pin 32 on IOM C1810 and BOB pin A36.</li> <li>• Is the resistance less than 5 ohms?</li> </ul>	<p>Yes = GO to <b>P11</b>.</p> <p>No = REPAIR the R/BK wire.</p>
<p><b>P11 CHECK BCM TO IOM DIAGNOSTIC OUTPUT CIRCUIT 4007 (Y/LG) FOR SHORT TO GROUND</b></p> <ul style="list-style-type: none"> <li>• With key OFF, measure the resistance between BOB pin B11 and ground (BOB pin A33).</li> <li>• Is the resistance greater than 10,000 ohms?</li> </ul>	<p>Yes = GO to <b>P12</b>.</p> <p>No = REPAIR the Y/LG wire.</p>
<p><b>P12 CHECK IOM TO BCM DIAGNOSTIC INPUT CIRCUIT 4008 (R/BK) FOR SHORT TO POWER</b></p> <ul style="list-style-type: none"> <li>• With key ON, measure the voltage between BOB pin A36 and ground (BOB pin A33).</li> <li>• Is the voltage greater than 0 volts?</li> </ul>	<p>Yes = REPAIR the R/BK wire.</p> <p>No = REPLACE the IOM.</p>
<p><b>P13 CHECK BATTERY TEMPERATURES AFTER STOP OF CHARGING</b></p>	

(Continued)

**DIAGNOSIS AND TESTING (Continued)****PINPOINT TEST P: IOM TO BCM DIAGNOSTIC INPUT STUCK HIGH FAULT**

TEST STEP	ACTION TO TAKE
<p><b>NOTE:</b> The IOM to BCM Diagnostic Signal Stuck High Fault is due to a rapid increase of temperature over time. If any of the battery temperature sensors indicate a temperature higher than 42°C (108°F), the BCM will operate the flow-thru and recirculation fans and not allow charging until the temperature falls below 42°C (108°F).</p> <ul style="list-style-type: none"> <li>Continue charging until the IOMH__F PID indicates YES.</li> <li>With key ON, monitor BCM PIDs TMPSEN1, TMPSEN2, and TMPSEN3.</li> <li><b>Are any of the temperatures 5°C (9°F) higher than the other two temperature sensors?</b></li> </ul>	<p>Yes = If TMPSEN1 is higher, REPLACE battery module 18. If TMPSEN2 is higher, REPLACE battery module 12. If TMPSEN3 is higher, REPLACE battery module 3.</p> <p>No = GO to <b>P14</b>.</p>
<p><b>P14 CHECK BATTERY MODULE CAPACITIES AFTER STOP OF CHARGING</b></p> <ul style="list-style-type: none"> <li>Enter BCM active command mode BATTERY MODULE SELECT, monitor BCM PID BAT__MC, and record the module capacity values for all 25 battery modules.</li> <li><b>Do battery modules 3, 12, or 18 indicate 15 amhours less than the rest of the battery modules in the battery pack?</b></li> </ul>	<p>Yes = If capacity for battery module 3 is less, REPLACE battery module 3. If capacity for battery module 12 is less, REPLACE battery module 12. If capacity for battery module 18 is less, REPLACE battery module 18.</p> <p>No = REPLACE the BCM.</p>

**PINPOINT TEST Q: IOM TO BCM DIAGNOSTIC INPUT STUCK LOW FAULT**

TEST STEP	ACTION TO TAKE
<p><b>Q1 CHECK BATTERY CONTROL MODULE (BCM) TO INDEPENDENT OBSERVER MODULE (IOM) DIAGNOSTIC OUTPUT CIRCUIT 4007 (Y/LG) FOR OPEN</b></p> <p><b>NOTE:</b> If an IOM to BCM Diagnostic Input Stuck Low Fault occurs, the 12-volt auxiliary battery negative cable must be disconnected and reconnected (power reset) to clear the latched fault from the BCM after the concern is repaired. If the power reset is not carried out, the BCM will not allow charging.</p> <ul style="list-style-type: none"> <li>Remove the traction battery and connect Traction Battery High-Voltage Lockout and Diagnostic Tool to the traction battery high-voltage two-pin C3994M.</li> </ul> <p> <b>WARNING: The traction battery contains high-voltage components and wiring. High-voltage insulated safety gloves and face shield must be worn when carrying out the following steps. Failure to follow this warning may result in severe personal injury or death.</b></p> <ul style="list-style-type: none"> <li>Connect 104-Pin Breakout Box (BOB) to BCM C1986, C1987 using the BCM/TIM BOB Adapter Cable and Overlay; leave the BCM disconnected.</li> <li>With key OFF, disconnect independent observer module (IOM) C1810 and measure the resistance of the Y/LG wire between pin 31 on IOM C1810 and BOB pin B11.</li> <li><b>Is the resistance less than 5 ohms?</b></li> </ul>	<p>Yes = GO to <b>Q2</b>.</p> <p>No = REPAIR the Y/LG wire.</p>
<p><b>Q2 CHECK IOM TO BCM DIAGNOSTIC INPUT CIRCUIT 4008 (R/BK) FOR SHORT TO GROUND</b></p> <ul style="list-style-type: none"> <li>With key OFF, measure the resistance between BOB pin A36 and ground (BOB pin A33).</li> </ul>	<p>Yes = GO to <b>Q3</b>.</p>

(Continued)

**DIAGNOSIS AND TESTING (Continued)****PINPOINT TEST Q: IOM TO BCM DIAGNOSTIC INPUT STUCK LOW FAULT**

TEST STEP	ACTION TO TAKE
<ul style="list-style-type: none"> <li>Is the resistance greater than 10,000 ohms?</li> </ul>	No = REPAIR the R/BK wire.
<b>Q3 CHECK BCM TO IOM DIAGNOSTIC OUTPUT CIRCUIT 4007 (Y/LG) FOR SHORT TO POWER</b> <ul style="list-style-type: none"> <li>Connect Traction Battery Low-Voltage Service Cord to traction battery support tray in-line C1939F and in-line C1939M.</li> <li>Connect Traction Battery High-Voltage Service Cord to traction battery support tray in-line C1935F and in-line C1935M.</li> <li>With key ON, measure the voltage between BOB pin B11 and ground (BOB pin A33).</li> <li>Is the voltage greater than 0 volt?</li> </ul>	Yes = REPAIR the Y/LG wire. No = REPLACE the IOM.

**PINPOINT TEST R: DTC C1859 PRNDL INPUT #2 CIRCUIT FAILURE**

TEST STEP	ACTION TO TAKE
<b>R1 CHECK STATUS OF DIGITAL TRANSMISSION RANGE (DTR) SENSOR SIGNAL TR2 TO BATTERY CONTROL MODULE (BCM)</b> <p><b>NOTE:</b> Verify the transmission range selector lever is in the Park (P) position.</p> <ul style="list-style-type: none"> <li>With key ON, monitor BCM PID TRANSGR.</li> <li>Does the TRANSGR PID indicate D6__PRK?</li> </ul>	Yes = System OK. CHECK wiring for intermittent connections. No = GO to <b>R2</b> .
<b>R2 CHECK CIRCUIT 3501 (DB) (OUTSIDE OF TRACTION BATTERY SUPPORT TRAY) FOR OPEN</b> <ul style="list-style-type: none"> <li>With key OFF, disconnect traction battery support tray in-line C1939 and connect 104-Pin Breakout Box (BOB) to in-line C1939M using Traction Battery Low-Voltage Service Cord; do not connect Traction Battery Low-Voltage Service Cord to in-line C1939F.</li> <li>With key OFF, disconnect digital transmission range (DTR) sensor C4996 and measure the resistance of the DB wire between pin 5 on DTR sensor C4996 and BOB pin 40.</li> <li>Is the resistance less than 5 ohms?</li> </ul>	Yes = GO to <b>R3</b> . No = REPAIR the DB wire.
<b>R3 CHECK CIRCUIT 3501 (DB) (INSIDE OF TRACTION BATTERY SUPPORT TRAY) FOR OPEN</b> <ul style="list-style-type: none"> <li>Disconnect the BOB from in-line C1939M, remove the traction battery, and connect Traction Battery High-Voltage Lockout and Diagnostic Tool to the traction battery high-voltage two-pin C3994M.</li> </ul> <p><b>⚠ WARNING: The traction battery contains high-voltage components and wiring. High-voltage insulated safety gloves and face shield must be worn when carrying out the following steps. Failure to follow this warning may result in severe personal injury or death.</b></p> <ul style="list-style-type: none"> <li>Connect 104-Pin Breakout Box (BOB) to traction battery support tray in-line C1939F and in-line C1939M using Traction Battery Low-Voltage Service Cord.</li> <li>With key OFF, disconnect BCM C1987 and measure the resistance of the DB wire between pin 17 on BCM C1987 and BOB pin 40.</li> <li>Is the resistance less than 5 ohms?</li> </ul>	Yes = GO to <b>R4</b> . No = REPAIR the DB wire.
<b>R4 CHECK FOR INTERMITTENT CONCERN(S)</b> <ul style="list-style-type: none"> <li>With key OFF, reconnect DTR sensor C4996 and BCM C1987.</li> <li>Carry out the on-demand self-test for the BCM.</li> <li>Does DTC C1859 PRNDL Input #2 Circuit Failure occur?</li> </ul>	Yes = REPLACE the BCM. No = System OK. CHECK wiring for intermittent connections.

**DIAGNOSIS AND TESTING (Continued)****PINPOINT TEST S: DTC C1861 PRNDL INPUT #4 CIRCUIT FAILURE**

<b>TEST STEP</b>	<b>ACTION TO TAKE</b>
<b>S1 CHECK STATUS OF DIGITAL TRANSMISSION RANGE (DTR) SENSOR SIGNAL TR4 TO BATTERY CONTROL MODULE (BCM)</b>  <b>NOTE:</b> Verify the transmission range selector lever is in the Park (P) position. <ul style="list-style-type: none"> <li>With key ON, monitor BCM PID TRANSGR.</li> <li><b>Does the TRANSGR PID indicate D6__PRK?</b></li> </ul>	Yes = System OK. CHECK wiring for intermittent connections.  No = GO to <b>S2</b> .
<b>S2 CHECK CIRCUIT 3503 (Y) (OUTSIDE OF TRACTION BATTERY SUPPORT TRAY) FOR OPEN</b> <ul style="list-style-type: none"> <li>With key OFF, disconnect traction battery support tray in-line C1939 and connect 104-Pin Breakout Box (BOB) to in-line C1939M using Traction Battery Low-Voltage Service Cord; do not connect Traction Battery Low-Voltage Service Cord to in-line C1939F.</li> <li>With key OFF, disconnect digital transmission range (DTR) sensor C4996 and measure the resistance of the Y wire between pin 6 on DTR sensor C4996 and BOB pin 52.</li> <li><b>Is the resistance less than 5 ohms?</b></li> </ul>	Yes = GO to <b>S3</b> .  No = REPAIR the Y wire.
<b>S3 CHECK CIRCUIT 3503 (Y) (INSIDE OF TRACTION BATTERY SUPPORT TRAY) FOR OPEN</b> <ul style="list-style-type: none"> <li>Disconnect the BOB from in-line C1939M, remove the traction battery, and connect Traction Battery High-Voltage Lockout and Diagnostic Tool to the traction battery high-voltage two-pin C3994M.</li> </ul> <p><b>⚠ WARNING: The traction battery contains high-voltage components and wiring. High-voltage insulated safety gloves and face shield must be worn when carrying out the following steps. Failure to follow this warning may result in severe personal injury or death.</b></p> <ul style="list-style-type: none"> <li>Connect 104-Pin Breakout Box (BOB) to traction battery support tray in-line C1939F and in-line C1939M using Traction Battery Low-Voltage Service Cord.</li> <li>With key OFF, disconnect BCM C1987 and measure the resistance of the Y wire between pin 18 on BCM C1987 and BOB pin 52.</li> <li><b>Is the resistance less than 5 ohms?</b></li> </ul>	Yes = GO to <b>S4</b> .  No = REPAIR the Y wire.
<b>S4 CHECK FOR INTERMITTENT CONCERN(S)</b> <ul style="list-style-type: none"> <li>With key OFF, reconnect DTR sensor C4996 and BCM C1987.</li> <li>Perform the on-demand self-test for the BCM.</li> <li><b>Does DTC C1861 PRNDL Input #4 Circuit Failure occur?</b></li> </ul>	Yes = REPLACE the BCM. No = System OK. CHECK wiring for intermittent connections.

**PINPOINT TEST T: DTC C1863 EXTERNAL CHARGING FAULT**

<b>TEST STEP</b>	<b>ACTION TO TAKE</b>
<b>T1 CHECK CHARGER CORD INPUT STATUS</b>  <b>NOTE:</b> Verify the power control station (PCS) charger cord is not plugged into the charger inlet before performing this test step. <ul style="list-style-type: none"> <li>With key ON, monitor BCM PID CHGCORD.</li> <li><b>Does the CHGCORD PID indicate IN?</b></li> </ul>	Yes = GO to <b>T2</b> .  No = System OK. CHECK wiring for intermittent connections.
<b>T2 CHECK CHARGER INLET CONNECTOR</b> <ul style="list-style-type: none"> <li>With key OFF, disconnect in-line C1969 (located on the chassis next to the right headlamp inside the underhood compartment).</li> <li>With key ON, monitor BCM PID CHGCORD.</li> <li><b>Does the CHGCORD PID indicate IN?</b></li> </ul>	Yes = GO to <b>T3</b> .  No = REPLACE the charger inlet assembly.

(Continued)

**DIAGNOSIS AND TESTING (Continued)****PINPOINT TEST T: DTC C1863 EXTERNAL CHARGING FAULT**

<b>TEST STEP</b>	<b>ACTION TO TAKE</b>
<b>T3 CHECK CHARGER CORD INPUT STATUS CIRCUIT FOR SHORT TO GROUND</b> <ul style="list-style-type: none"> <li>With key OFF, measure the resistance between the Y wire on in-line C1969M and ground.</li> <li><b>Is the resistance greater than 10,000 ohms?</b></li> </ul>	Yes = REPLACE the BCM. No = GO to T4.
<b>T4 CHECK TRACTION INVERTER MODULE (TIM) FOR SHORT TO GROUND</b> <ul style="list-style-type: none"> <li>With key OFF, disconnect TIM C4998 and measure the resistance between the Y wire on in-line C1969M and ground.</li> <li><b>Is the resistance greater than 10,000 ohms?</b></li> </ul>	Yes = REPLACE the TIM. REFER to Section 303-14. No = GO to T5.
<b>T5 CHECK CIRCUIT 3404 (Y) (OUTSIDE TRACTION BATTERY SUPPORT TRAY) FOR SHORT TO GROUND</b> <ul style="list-style-type: none"> <li>With key OFF, disconnect in-line C1939 on the traction battery support tray and measure the resistance between the Y wire on in-line C1969M and ground.</li> <li><b>Is the resistance greater than 10,000 ohms?</b></li> </ul>	Yes = GO to T6. No = REPAIR the Y wire (outside the traction battery support tray).
<b>T6 CHECK CIRCUIT 3404 (Y) (INSIDE TRACTION BATTERY SUPPORT TRAY) FOR SHORT TO GROUND</b> <ul style="list-style-type: none"> <li>Remove the traction battery and connect Traction Battery High-Voltage Lockout and Diagnostic Tool to the traction battery high-voltage two-pin C3994M.</li> <li>Connect 104-Pin Breakout Box (BOB) to traction battery support tray in-line C1939F using Traction Battery Low-Voltage Service Cord; do not connect Traction Battery Low-Voltage Service Cord to in-line C1939M.</li> </ul> <p> <b>WARNING: The traction battery contains high-voltage components and wiring. High-voltage insulated safety gloves and face shield must be worn when carrying out the following steps. Failure to follow this warning may result in severe personal injury or death.</b></p> <ul style="list-style-type: none"> <li>With key OFF, disconnect BCM C1987 and measure the resistance between BOB pin 54 and ground (BOB pin 65).</li> <li><b>Is the resistance greater than 10,000 ohms?</b></li> </ul>	Yes = REPLACE the BCM. No = REPAIR the Y wire (inside the traction battery support tray).

**PINPOINT TEST U: POWER CONTROL STATION (PCS) OPERATION VERIFICATION TEST**

<b>TEST STEP</b>	<b>ACTION TO TAKE</b>
<b>U1 CHECK POWER CONTROL STATION (PCS) SERVICE LIGHT</b> <p><b>NOTE:</b> If turning the power on and off or unplugging and plugging the PCS from the charger inlet connector does not cause any of the lights on the PCS to illuminate, the PCS has either failed or has a damaged cord. Call the manufacturer for repair or replacement.</p> <ul style="list-style-type: none"> <li>Verify the PCS is correctly inserted into the vehicle's charger inlet connector and locked in place.</li> <li>Check the Protection light (EVI manufacturer) or the Charge Interrupted light (SCI manufacturer) on the PCS.</li> <li><b>Is the Protection light (EVI manufacturer) or the Charge Interrupted light (SCI manufacturer) illuminated?</b></li> </ul>	Yes = GO to U2. No = GO to U3.
<b>U2 CLEAR THE FAULT AND RECHECK</b>	

(Continued)





**DIAGNOSIS AND TESTING (Continued)**

**Traction Battery Cooling/Ventilation System**

**Diagnostic Trouble Code (DTC) Definition**

The following DTC relates to the traction battery cooling/ventilation system:

- DTC B2513 Blower (Fan) Circuit Failure
  - The traction battery support tray contains a flow-thru fan that draws in outside air to cool the battery pack and a recirculation fan for recirculating the air to maintain even temperature within the battery pack. The battery control module (BCM) sets DTC B2513 if a failure occurs with the flow-thru fan or recirculation fan. The BCM uses PIDs to indicate if a flow-thru fan or recirculation fan fault occurs. A flow-thru fan fault occurs if the BCM does not receive a feedback signal when the flow-thru fan is enabled or if it receives a feedback signal after it has been disabled. A recirculation fan fault occurs if the BCM does not receive a feedback signal when the recirculation fan has been enabled.

**Electrical Schematic**

Refer to Electrical and Vacuum Troubleshooting Manual, Cell 19, Traction Battery Cooling/Ventilation for schematic and connector information.

**Inspection and Verification**

Refer to [Section 100-07](#).

**Symptom Chart**

**Symptom Chart**

Condition	Possible Sources	Action
<ul style="list-style-type: none"> <li>• DTC B2513 Blower (Fan) Circuit Failure</li> </ul>	<ul style="list-style-type: none"> <li>• Fuse.</li> <li>• Circuit(s).</li> <li>• Flow-thru fan relay.</li> <li>• Flow-thru fan.</li> <li>• Recirculation fan relay.</li> <li>• Recirculation fan.</li> <li>• Battery control module (BCM).</li> </ul>	<ul style="list-style-type: none"> <li>• GO to Pinpoint Test A.</li> </ul>

**Pinpoint Tests**

**Special Tool(s)**

104-Pin Breakout Box (BOB) 418-049 (014-00950) or equivalent
BCM/TIM Breakout Box (BOB) Adapter Cable 418-F212
BCM/TIM Breakout Box (BOB) Overlay 418-F220

(Continued)

**Special Tool(s)**

Traction Battery High-Voltage Service Cord 418-F218
Traction Battery Low-Voltage Service Cord 418-F219
Traction Battery High-Voltage Lockout and Diagnostic Tool 418-F207
High-Voltage Insulated Safety Gloves 100-F036 or equivalent
Face Shield 100-F035 or equivalent

**DIAGNOSIS AND TESTING (Continued)****PINPOINT TEST A: DTC B2513 BLOWER (FAN) CIRCUIT FAILURE**

TEST STEP	ACTION TO TAKE
<p><b>A1 CHECK TRACTION BATTERY FANS FAULT STATUS</b></p> <ul style="list-style-type: none"> <li>With key ON, monitor battery control module (BCM) PIDs FLOW__F and RECIR__F.</li> </ul> <p>• <b>Does the FLOW__F PID or RECIR__F PID indicate YES?</b></p>	<p>Yes = If both PIDs indicate YES, GO to <b>A2</b>. If FLOW__F PID indicates YES, GO to <b>A4</b>. If RECIR__F PID indicates YES, GO to <b>A15</b>.</p> <p>No = System OK. CHECK wiring for intermittent connections.</p>
<p><b>A2 CHECK FUSE AND POWER TO TRACTION BATTERY FAN RELAYS AT TRACTION BATTERY SUPPORT TRAY</b></p> <ul style="list-style-type: none"> <li>Check 15A fuse 17 in the electric vehicle power distribution box (EVPDB).</li> <li>With key OFF, disconnect traction battery support tray in-line C1939 and connect 104-Pin Breakout Box (BOB) to in-line C1939M using Traction Battery Low-Voltage Service Cord; do not connect Traction Battery Low-Voltage Service Cord to in-line C1939F.</li> <li>With key OFF, measure the voltage between BOB pin 64 and ground (BOB pin 65). (V &gt; 10 volts)</li> </ul> <p>• <b>Is everything OK?</b></p>	<p>Yes = GO to <b>A3</b>.</p> <p>No = REPAIR as necessary.</p>
<p><b>A3 CHECK GROUND TO TRACTION BATTERY FANS</b></p> <ul style="list-style-type: none"> <li>Disconnect the BOB from in-line C1939M, remove the traction battery, and connect Traction Battery High-Voltage Lockout and Diagnostic Tool to the traction battery high-voltage two-pin C3994M.</li> </ul> <p> <b>WARNING: The traction battery contains high-voltage components and wiring. High-voltage insulated safety gloves and face shield must be worn when carrying out the following steps. Failure to follow this warning may result in severe personal injury or death.</b></p> <ul style="list-style-type: none"> <li>With key OFF, measure the resistance between pin 1 (BK wire) on recirculation fan C1801 and ground (BCM case).</li> </ul> <p>• <b>Is the resistance less than 5 ohms?</b></p>	<p>Yes = REPAIR circuit 554 (Y/BK wire) between C1939F and the traction battery fan relay connectors.</p> <p>No = REPAIR the BK wire.</p>
<p><b>A4 CHECK FLOW-THRU FAN POWER STATUS</b></p> <p><b>NOTE:</b> If an emergency power off (EPO) condition occurs, the fan power will be disabled. If interface adapter assembly (IAA) module DTC B2517 Emergency Power Off System Faulted occurred, carry out the appropriate diagnostic procedures before carrying out this test step. Refer to the IAA Module DTC Index in Section 100-07.</p> <ul style="list-style-type: none"> <li>Enter BCM active command mode BCM PACKETED COMMANDS, monitor BCM PID FAN__FL, and set active command FAN__FL to ENABLE.</li> </ul> <p>• <b>Does the FAN__FL PID indicate ENABLE?</b></p>	<p>Yes = GO to <b>A5</b>.</p> <p>No = REPLACE the BCM.</p>
<p><b>A5 CHECK FLOW-THRU FAN FEEDBACK STATUS</b></p> <p><b>NOTE:</b> The vehicle may need to be lifted on a hoist to hear the flow-thru fan operate.</p> <ul style="list-style-type: none"> <li>Enter BCM active command mode BCM PACKETED COMMANDS, monitor BCM PID FLOWFBK, and set active command FAN__FL to ENABLE.</li> </ul> <p>• <b>Does the FLOWFBK PID indicate ENABLE?</b></p>	<p>Yes = GO to <b>A6</b>.</p> <p>No = If fan operates, GO to <b>A12</b>. If fan does not operate, GO to <b>A7</b>.</p>

(Continued)

**DIAGNOSIS AND TESTING (Continued)****PINPOINT TEST A: DTC B2513 BLOWER (FAN) CIRCUIT FAILURE**

TEST STEP	ACTION TO TAKE
<p><b>A6 CHECK CIRCUIT 3851 (Y/R) FOR SHORT TO POWER</b></p> <ul style="list-style-type: none"> <li>Remove the traction battery and connect Traction Battery High-Voltage Lockout and Diagnostic Tool to the traction battery high-voltage two-pin C3994M.</li> </ul> <p><b>⚠ WARNING: The traction battery contains high-voltage components and wiring. High-voltage insulated safety gloves and face shield must be worn when carrying out the following steps. Failure to follow this warning may result in severe personal injury or death.</b></p> <ul style="list-style-type: none"> <li>Connect Traction Battery Low-Voltage Service Cord to traction battery support tray in-line C1939F and in-line C1939M.</li> <li>Connect Traction Battery High-Voltage Service Cord to traction battery support tray in-line C1935F and in-line C1935M.</li> <li>Connect BOB to BCM C1986, C1987 using the BCM/TIM BOB Adapter Cable and Overlay; leave the BCM disconnected.</li> <li>With key OFF, disconnect flow-thru fan C1802.</li> <li>With key ON, measure the voltage between BOB pin B6 and ground (BOB pin A33).</li> <li><b>Is the voltage greater than 10 volts?</b></li> </ul>	<p>Yes = REPAIR the Y/R wire.</p> <p>No = REPLACE the flow-thru fan.</p>
<p><b>A7 CHECK POWER TO FLOW-THRU FAN</b></p> <ul style="list-style-type: none"> <li>Remove the traction battery and connect Traction Battery High-Voltage Lockout and Diagnostic Tool to the traction battery high-voltage two-pin C3994M.</li> </ul> <p><b>⚠ WARNING: The traction battery contains high-voltage components and wiring. High-voltage insulated safety gloves and face shield must be worn when carrying out the following steps. Failure to follow this warning may result in severe personal injury or death.</b></p> <ul style="list-style-type: none"> <li>Connect Traction Battery Low-Voltage Service Cord to traction battery support tray in-line C1939F and in-line C1939M.</li> <li>Connect Traction Battery High-Voltage Service Cord to traction battery support tray in-line C1935F and in-line C1935M.</li> <li>With key OFF, disconnect flow-thru fan C1802.</li> <li>Enter BCM active command mode BCM PACKETED COMMANDS and set active command FAN_FL to ENABLE.</li> <li>Measure the voltage between pin 2 (O/LB wire) and pin 1 (BK wire) on flow-thru fan C1802.</li> <li><b>Is the voltage greater than 10 volts?</b></li> </ul>	<p>Yes = REPLACE the flow-thru fan.</p> <p>No = GO to A8.</p>
<p><b>A8 CHECK GROUND TO FLOW-THRU FAN</b></p> <ul style="list-style-type: none"> <li>With key OFF, measure the resistance between pin 1 (BK wire) on flow-thru fan C1802 and ground (BCM case).</li> <li><b>Is the resistance less than 5 ohms?</b></li> </ul>	<p>Yes = GO to A9.</p> <p>No = REPAIR the BK wire.</p>
<p><b>A9 CHECK POWER TO FLOW-THRU FAN RELAY</b></p> <ul style="list-style-type: none"> <li>Disconnect flow-thru fan relay C1983 and measure the voltage between pin 86 (Y/BK wire), pin 87 (Y/BK wire) on flow-thru fan relay C1983 and ground.</li> <li><b>Are the voltages greater than 10 volts?</b></li> </ul>	<p>Yes = GO to A10.</p> <p>No = REPAIR the Y/BK wire(s).</p>
<p><b>A10 CHECK FLOW-THRU FAN RELAY</b></p> <ul style="list-style-type: none"> <li>Connect 12-volts to pin 86 and ground to pin 85 on the flow-thru fan relay.</li> <li>Measure the resistance between pins 30 and 87 on the flow-thru fan relay.</li> <li><b>Is the resistance less than 5 ohms?</b></li> </ul>	<p>Yes = GO to A11.</p> <p>No = REPLACE the flow-thru fan relay.</p>
<p><b>A11 CHECK CIRCUITS 3850 (LG/P) AND 3395 (O/LB) FOR OPEN(S)</b></p>	

(Continued)

**DIAGNOSIS AND TESTING (Continued)****PINPOINT TEST A: DTC B2513 BLOWER (FAN) CIRCUIT FAILURE**

TEST STEP	ACTION TO TAKE
<ul style="list-style-type: none"> <li>Connect BOB to BCM C1986, C1987 using the BCM/TIM BOB Adapter Cable and Overlay; leave the BCM disconnected.</li> <li>With key OFF, measure the resistance of the LG/P wire between pin 85 on flow-thru fan relay C1983 and BOB pin B23.</li> <li>With key OFF, measure the resistance of the O/LB wire between pin 30 on flow-thru fan relay C1983 and pin 2 on flow-thru fan C1802.</li> <li><b>Are the resistances less than 5 ohms?</b></li> </ul>	<p>Yes = REPLACE the BCM.</p> <p>No = REPAIR the wire(s) in question.</p>
<p><b>A12 CHECK FAN FEEDBACK SIGNAL TO BCM</b></p> <ul style="list-style-type: none"> <li>Remove the traction battery and connect Traction Battery High-Voltage Lockout and Diagnostic Tool to the traction battery high-voltage two-pin C3994M.</li> </ul> <p><b>⚠ WARNING: The traction battery contains high-voltage components and wiring. High-voltage insulated safety gloves and face shield must be worn when carrying out the following steps. Failure to follow this warning may result in severe personal injury or death.</b></p> <ul style="list-style-type: none"> <li>Connect Traction Battery Low-Voltage Service Cord to traction battery support tray in-line C1939F and in-line C1939M.</li> <li>Connect Traction Battery High-Voltage Service Cord to traction battery support tray in-line C1935F and in-line C1935M.</li> <li>Connect BOB to BCM and BCM C1986, C1987 using the BCM/TIM BOB Adapter Cable and Overlay.</li> <li>Enter BCM active command mode BCM PACKETED COMMANDS, set active command FAN_FL to ENABLE, and measure the voltage between BOB pin B6 and ground (BOB pin A33).</li> <li><b>Is the voltage between 2.75 and 3.75 volts?</b></li> </ul>	<p>Yes = System OK. CHECK wiring for intermittent connections.</p> <p>No = If voltage is less than 1 volt, GO to A13.</p> <p>If voltage is greater than 4 volts, REPLACE the BCM.</p>
<p><b>A13 CHECK CIRCUIT 3851 (Y/R) FOR OPEN</b></p> <ul style="list-style-type: none"> <li>With key OFF, measure the resistance of the Y/R wire between pin 3 on flow-thru fan C1802 and BOB pin B6.</li> <li><b>Is the resistance less than 5 ohms?</b></li> </ul>	<p>Yes = GO to A14.</p> <p>No = REPAIR the Y/R wire.</p>
<p><b>A14 CHECK CIRCUIT 3851 (Y/R) FOR SHORT TO GROUND</b></p> <ul style="list-style-type: none"> <li>With key OFF, disconnect BOB from BCM; leave BOB connected to BCM C1986, C1987.</li> <li>With key OFF, measure the resistance between BOB pin B6 and ground (BOB pin A33).</li> <li><b>Is the resistance greater than 10,000 ohms?</b></li> </ul>	<p>Yes = REPLACE the flow-thru fan.</p> <p>No = REPAIR the Y/R wire.</p>
<p><b>A15 CHECK RECIRCULATION FAN POWER STATUS</b></p> <p><b>NOTE:</b> If an emergency power off (EPO) condition occurs, the fan power will be disabled. If interface adapter assembly (IAA) module DTC B2517 Emergency Power Off System Faulted occurred, carry out the appropriate diagnostic procedures before carrying out this test step. Refer to the IAA Module DTC Index in Section 100-07.</p> <ul style="list-style-type: none"> <li>Enter BCM active command mode BCM PACKETED COMMANDS, monitor BCM PID FAN_RE, and set active command FAN_RE to ENABLE.</li> <li><b>Does the FAN_RE PID indicate ENABLE?</b></li> </ul>	<p>Yes = GO to A16.</p> <p>No = REPLACE the BCM.</p>
<p><b>A16 CHECK RECIRCULATION FAN FEEDBACK STATUS</b></p> <p><b>NOTE:</b> Wait two minutes for the recirculation fan to reach full speed. The vehicle may need to be lifted on a hoist to hear the recirculation fan operate.</p> <ul style="list-style-type: none"> <li>Enter BCM active command mode BCM PACKETED COMMANDS, monitor BCM PID FANFDBK, and set active command FAN_RE to ENABLE.</li> </ul>	<p>Yes = GO to A17.</p>

(Continued)

**DIAGNOSIS AND TESTING (Continued)****PINPOINT TEST A: DTC B2513 BLOWER (FAN) CIRCUIT FAILURE**

TEST STEP	ACTION TO TAKE
<ul style="list-style-type: none"> <li>Does the FANFDBK PID indicate ENABLE?</li> </ul>	No = If fan operates, GO to A23. If fan does not operate, GO to A18.
<b>A17 CHECK CIRCUIT 3605 (DB/W) FOR SHORT TO POWER</b> <ul style="list-style-type: none"> <li>Remove the traction battery and connect Traction Battery High-Voltage Lockout and Diagnostic Tool to the traction battery high-voltage two-pin C3994M.</li> </ul> <p><b>⚠ WARNING: The traction battery contains high-voltage components and wiring. High-voltage insulated safety gloves and face shield must be worn when carrying out the following steps. Failure to follow this warning may result in severe personal injury or death.</b></p> <ul style="list-style-type: none"> <li>Connect Traction Battery Low-Voltage Service Cord to traction battery support tray in-line C1939F and in-line C1939M.</li> <li>Connect Traction Battery High-Voltage Service Cord to traction battery support tray in-line C1935F and in-line C1935M.</li> <li>With key OFF, disconnect recirculation fan C1801.</li> <li>With key ON, measure the voltage between BOB pin A28 and ground (BOB pin A33).</li> <li>Is the voltage greater than 10 volts?</li> </ul>	Yes = REPAIR the DB/W wire.  No = REPLACE the recirculation fan.
<b>A18 CHECK POWER TO RECIRCULATION FAN</b> <ul style="list-style-type: none"> <li>Remove the traction battery and connect Traction Battery High-Voltage Lockout and Diagnostic Tool to the traction battery high-voltage two-pin C3994M.</li> </ul> <p><b>⚠ WARNING: The traction battery contains high-voltage components and wiring. High-voltage insulated safety gloves and face shield must be worn when carrying out the following steps. Failure to follow this warning may result in severe personal injury or death.</b></p> <ul style="list-style-type: none"> <li>Connect Traction Battery Low-Voltage Service Cord to traction battery support tray in-line C1939F and in-line C1939M.</li> <li>Connect Traction Battery High-Voltage Service Cord to traction battery support tray in-line C1935F and in-line C1935M.</li> <li>Connect BOB to BCM and BCM C1986, C1987 using the BCM/TIM BOB Adapter Cable and Overlay.</li> <li>With key OFF, disconnect recirculation fan C1801.</li> <li>Enter BCM active command mode BCM PACKETED COMMANDS and set active command FAN__RE to ENABLE.</li> <li>Measure the voltage between pin 2 (Y/LG wire) and pin 1 (BK wire) on recirculation fan C1801.</li> <li>Is the voltage greater than 10 volts?</li> </ul>	Yes = REPLACE the recirculation fan.  No = GO to A19.
<b>A19 CHECK GROUND TO RECIRCULATION FAN</b> <ul style="list-style-type: none"> <li>With key OFF, measure the resistance between pin 1 (BK wire) on recirculation fan C1801 and ground (BCM case).</li> <li>Is the resistance less than 5 ohms?</li> </ul>	Yes = GO to A20.  No = REPAIR the BK wire.
<b>A20 CHECK POWER TO RECIRCULATION FAN RELAY</b> <ul style="list-style-type: none"> <li>Disconnect recirculation fan relay C2038 and measure the voltage between pin 86 (Y/BK wire), pin 87 (Y/BK wire) on recirculation fan relay C2038 and ground.</li> <li>Are the voltages greater than 10 volts?</li> </ul>	Yes = GO to A21.  No = REPAIR the Y/BK wire(s).
<b>A21 CHECK RECIRCULATION FAN RELAY</b> <ul style="list-style-type: none"> <li>Connect 12-volts to pin 86 and ground to pin 85 on the recirculation fan relay.</li> </ul>	Yes = GO to A22.

(Continued)

**DIAGNOSIS AND TESTING (Continued)****PINPOINT TEST A: DTC B2513 BLOWER (FAN) CIRCUIT FAILURE**

TEST STEP	ACTION TO TAKE
<ul style="list-style-type: none"> <li>Measure the resistance between pins 30 and 87 on the recirculation fan relay.</li> <li><b>Is the resistance less than 5 ohms?</b></li> </ul>	No = REPLACE the recirculation fan relay.
<b>A22 CHECK CIRCUITS 3852 (BK/LG) AND 3396 (Y/LG) FOR OPEN(S)</b> <ul style="list-style-type: none"> <li>With key OFF, measure the resistance of the BK/LG wire between pin 85 on recirculation fan relay C2038 and BOB pin B10.</li> <li>With key OFF, measure the resistance of the Y/LG wire between pin 30 on recirculation fan relay C2038 and pin 2 on recirculation fan C1801.</li> <li><b>Are the resistances less than 5 ohms?</b></li> </ul>	Yes = REPLACE the BCM.  No = REPAIR the wire(s) in question.
<b>A23 CHECK FAN FEEDBACK SIGNAL TO BCM</b> <ul style="list-style-type: none"> <li>Remove the traction battery and connect Traction Battery High-Voltage Lockout and Diagnostic Tool to the traction battery high-voltage two-pin C3994M.</li> </ul> <p><b>⚠ WARNING: The traction battery contains high-voltage components and wiring. High-voltage insulated safety gloves and face shield must be worn when carrying out the following steps. Failure to follow this warning may result in severe personal injury or death.</b></p> <ul style="list-style-type: none"> <li>Connect Traction Battery Low-Voltage Service Cord to traction battery support tray in-line C1939F and in-line C1939M.</li> <li>Connect Traction Battery High-Voltage Service Cord to traction battery support tray in-line C1935F and in-line C1935M.</li> <li>Connect BOB to BCM and BCM C1986, C1987 using the BCM/TIM BOB Adapter Cable and Overlay.</li> </ul> <p><b>NOTE:</b> Wait two minutes for recirculation fan to reach full speed.</p> <ul style="list-style-type: none"> <li>Enter BCM active command mode BCM PACKETED COMMANDS, set active command FAN__RE to ENABLE, and measure the voltage between BOB pin A28 and ground (BOB pin A33).</li> <li><b>Is the voltage between 2.5 and 3.5 volts?</b></li> </ul>	Yes = System OK. CHECK wiring for intermittent connections.  No = If voltage is greater than 4.75 volts, GO to <b>A24</b> .  If voltage is less than 1 volt, GO to <b>A25</b> .
<b>A24 CHECK CIRCUIT 3605 (DB/W) FOR OPEN</b> <ul style="list-style-type: none"> <li>With key OFF, measure the resistance of the DB/W wire between pin 3 on recirculation fan C1801 and BOB pin A28.</li> <li><b>Is the resistance less than 5 ohms?</b></li> </ul>	Yes = REPLACE the recirculation fan. No = REPAIR the DB/W wire.
<b>A25 CHECK FEEDBACK CIRCUIT</b> <ul style="list-style-type: none"> <li>With key OFF, disconnect recirculation fan C1801.</li> <li>With key ON, measure the voltage between pin 3 (DB/W wire) on recirculation fan C1801 and ground.</li> <li><b>Is the voltage greater than 4.75 volts?</b></li> </ul>	Yes = REPLACE the recirculation fan. No = GO to <b>A26</b> .
<b>A26 CHECK CIRCUIT 3605 (DB/W) FOR SHORT TO GROUND</b> <ul style="list-style-type: none"> <li>With key OFF, disconnect BOB from BCM; leave BOB connected to BCM C1986, C1987.</li> <li>With key OFF, measure the resistance between BOB pin A28 and ground (BOB pin A33).</li> <li><b>Is the resistance greater than 10,000 ohms?</b></li> </ul>	Yes = REPLACE the BCM. No = REPAIR the DB/W wire.

**DIAGNOSIS AND TESTING (Continued)****Traction Battery System****Battery Module Diagnostic Test**

The Battery Module Diagnostic Test is the method used to analyze electric vehicle traction battery modules. All 25 battery modules are analyzed simultaneously.



## DIAGNOSIS AND TESTING (Continued)

**NOTE:** This is a two-phase process. Battery module voltage information must be recorded within five minutes of completing discharge of the traction battery.

**NOTE:** Discharge the traction battery until the Power Limit Light flashes, preferably by driving the vehicle.

- Step 1
- Using the NGS Tester, select the current year and model for the vehicle being serviced.
- Select Diagnostic Data Link.
- Select Battery Control Module.
- Select Active Commands Modes.
- Select Battery Module Select.
- Press #8 SETUP button.
- Select Auto and Hit CANCEL button.
- Press #7 PIDS button and highlight BAT\_MV.
- Hit START button.
- Press TRIGGER and rotate knob to view each battery module. SCROLL through each battery module and record the information.
- Step 2
- Press CANCEL.
- Select Battery Module Select and press ENTER.
- Press the SETUP button and select Auto Send.
- Press CANCEL.
- Press #7 (PIDS) and select BAT\_MC and SOC. <sup>a</sup>
- Press START.
- Press TRIGGER and SCROLL through the Battery Modules recording the information.
- Contact the National Hotline 1-800-826-4694.

### Diagnostic Trouble Code (DTC) Definition

The following DTCs relate to the traction battery system:

- DTC C1755 Power Limit Shutdown Fault

- The traction inverter module (TIM) sets DTC C1755 when the vehicle is shut down for one of three reasons: the temperature protection within the TIM has limited current to zero amps, the battery control module (BCM) sent the TIM a request to limit source current to zero, or due to an overspeed shutdown. If any of these occur, the vehicle shuts down, the malfunction indicator lamp (MIL) illuminates and the power limit warning indicator flashes. The cause of the shutdown is not necessarily due to the TIM. The cooling system loop and traction battery should be checked for faults. The TIM should not be replaced unless the vehicle continues to shut down and no other failures can be detected.
- DTC P1794 Battery Voltage Circuit Malfunction
  - The battery control module (BCM) monitors the 25 individual 12-volt traction battery modules through voltage sense lines. The BCM can sense the battery module voltages if they are within the range of 3 and 16.8 volts. The BCM sets DTC P1794 if it cannot sense three or more battery module voltages.
- DTC B1671 Battery Module Voltage Out of Range
  - The battery control module (BCM) monitors the 25 individual 12-volt traction battery modules through voltage sense lines. The BCM can sense the battery module voltages if they are within the range of 3 and 16.8 volts. The BCM sets DTC B1671 if it cannot sense one or two battery module voltages.
- DTC B1676 Battery Pack Voltage Out of Range
  - The battery control module (BCM) monitors the traction battery voltage through the TB+ and TB- voltage sense lines. The TB+ voltage sense line is connected to battery module 25 and TB- voltage sense line is connected to battery module 1. The BCM sets DTC B1676 if it detects the traction battery voltage to be less than 50 volts or greater than 450 volts. This is usually due to an open or shorted TB+ or TB- voltage sense line.

<sup>a</sup> Do not select BAT\_SOC.

**DIAGNOSIS AND TESTING (Continued)**

## • DTC C1864 Battery Module Fault

— The battery control module (BCM) monitors the 25 individual 12-volt traction battery modules through voltage sense lines. The BCM sets DTC C1864 if it detects a reverse battery module voltage due to incorrect installation (at initial 12-volt powerup), or if it detects the wrong hardware (NiMH BCM in a lead acid battery pack) has been installed into the battery pack.

## • DTC B2236 Weak or Defective Electric Vehicle Battery Module Fault

— The battery control module (BCM) monitors the 25 individual 12-volt traction battery modules through voltage sense lines. The BCM sets DTC B2236 if it detects a bad battery module (capacity is lower than normal or SOC is lower than the other modules) during discharge or if it detects any weaker battery modules (module voltage is lower than the average module voltage by more than one volt) that are much weaker than the rest at the end of charge.

**Electrical Schematic**

Refer to Electrical and Vacuum Troubleshooting Manual, Cell 16, Traction Battery System for schematic and connector information.

**Inspection and Verification**

Refer to [Section 100-07](#).

**Symptom Chart****Symptom Chart**

Condition	Possible Sources	Action
• DTC C1755 Power Limit Shutdown Fault	<ul style="list-style-type: none"> <li>• Cooling system.</li> <li>• Traction battery fault.</li> <li>• Motor/transaxle.</li> <li>• Traction inverter module (TIM).</li> </ul>	• GO to Pinpoint Test A.
• DTC B1671 Battery Module Voltage Out of Range	<ul style="list-style-type: none"> <li>• Battery module(s).</li> <li>• High-voltage harness (10B694).</li> <li>• High-voltage harness(es) (14A280).</li> <li>• Battery control module (BCM).</li> </ul>	• GO to Pinpoint Test B.
• DTC B1676 Battery Pack Voltage Out of Range	<ul style="list-style-type: none"> <li>• High-voltage harness (10B694).</li> <li>• High-voltage harness(es) (14A280).</li> <li>• Battery control module (BCM).</li> </ul>	• GO to Pinpoint Test B.
• DTC P1794 Battery Voltage Circuit Malfunction	<ul style="list-style-type: none"> <li>• Battery module(s).</li> <li>• High-voltage harness (10B694).</li> <li>• High-voltage harness(es) (14A280).</li> <li>• Battery control module (BCM).</li> </ul>	• GO to Pinpoint Test B.

**DIAGNOSIS AND TESTING (Continued)****Symptom Chart (Continued)**

Condition	Possible Sources	Action
<ul style="list-style-type: none"> <li>DTC C1864 Battery Module Fault</li> </ul>	<ul style="list-style-type: none"> <li>Battery module(s) installed incorrectly (reverse cable polarity).</li> <li>Incorrect battery module (12-volt) installed.</li> <li>Battery control module (BCM).</li> </ul>	<ul style="list-style-type: none"> <li>GO to Pinpoint Test C.</li> </ul>
<ul style="list-style-type: none"> <li>DTC B2236 Weak or Defective Electric Vehicle Battery Module Fault</li> </ul>	<ul style="list-style-type: none"> <li>Battery module(s).</li> </ul>	<ul style="list-style-type: none"> <li>GO to Pinpoint Test D.</li> </ul>
<ul style="list-style-type: none"> <li>Battery Pack/Module Verification Test</li> </ul>	<ul style="list-style-type: none"> <li>None.</li> </ul>	<ul style="list-style-type: none"> <li>GO to Pinpoint Test E.</li> </ul>

**Pinpoint Tests****Special Tool(s)**

104-Pin Breakout Box (BOB) 418-049 (014-00950) or equivalent
BCM/TIM Breakout Box (BOB) Adapter Cable 418-F212
BCM/TIM Breakout Box (BOB) Overlay 418-F220

(Continued)

**Special Tool(s)**

Traction Battery High-Voltage Service Cord 418-F218
Traction Battery Low-Voltage Service Cord 418-F219
Traction Battery High-Voltage Lockout and Diagnostic Tool 418-F207
High-Voltage Insulated Safety Gloves 100-F036 or equivalent
Face Shield 100-F035 or equivalent

**PINPOINT TEST A: DTC P1755 POWER LIMIT SHUTDOWN FAULT**

TEST STEP	ACTION TO TAKE
<b>A1 CHECK FOR OTHER TRACTION INVERTER MODULE (TIM) DIAGNOSTIC TROUBLE CODES (DTCs)</b>  <b>NOTE:</b> DTCs must be retrieved from the interface adapter assembly (IAA) module before retrieving DTCs from the TIM. If IAA module DTC C1774 Coolant Temperature Sensor Out of Range occurs, refer to Section 303-03 before proceeding. <ul style="list-style-type: none"> <li>Retrieve DTCs from the TIM.</li> <li><b>Does DTC C1854 Motor Temperature Out of Range also occur?</b></li> </ul>	Yes = REFER to Section 303-14.  No = GO to A2.
<b>A2 CHECK BATTERY CONTROL MODULE (BCM) FOR DTCs</b> <ul style="list-style-type: none"> <li>Retrieve DTCs from the BCM.</li> <li><b>Do any BCM DTCs occur?</b></li> </ul>	Yes = REFER to the BCM DTC Index in Section 100-07.  No = GO to A3.
<b>A3 CHECK DIFFERENCE BETWEEN COOLANT TEMPERATURE AND MOTOR/TRANSAXLE TEMPERATURE</b> <ul style="list-style-type: none"> <li>With key ON, monitor IAA module PID CLNTTMP and TIM PID MTRTMP.</li> <li><b>Is the temperature difference between the CLNTTMP and MTRTEMP PIDs greater than 30°C (86°F)?</b></li> </ul>	Yes = REPLACE the motor/transaxle. REFER to Section 303-01.  No = REPLACE the TIM. REFER to Section 303-14.

**PINPOINT TEST B: BATTERY PACK/MODULE(S) VOLTAGE OUT OF RANGE**

TEST STEP	ACTION TO TAKE
<b>B1 CHECK FOR OTHER BATTERY CONTROL MODULE (BCM) DIAGNOSTIC TROUBLE CODES (DTCs)</b> <ul style="list-style-type: none"> <li>Carry out the on-demand self-test for the BCM.</li> </ul>	Yes = GO to Pinpoint Test C.

(Continued)

**DIAGNOSIS AND TESTING (Continued)****PINPOINT TEST B: BATTERY PACK/MODULE(S) VOLTAGE OUT OF RANGE**

TEST STEP	ACTION TO TAKE
<ul style="list-style-type: none"> <li>Does DTC C1864 Battery Module Fault occur?</li> </ul>	No = GO to <b>B2</b> . If DTC B1676 Battery Pack Voltage Out of Range occurs, GO to <b>B8</b> .
<b>B2 CARRY OUT THE BATTERY MODULE DIAGNOSTIC TEST</b> <ul style="list-style-type: none"> <li>With key ON, carry out the Battery Module Diagnostic Test. Refer to the procedure in Traction Battery System.</li> </ul> <ul style="list-style-type: none"> <li>Does the Battery Module Diagnostic Test Function Test indicate to replace any battery modules or to correct any other concerns?</li> </ul>	Yes = If the B integer value is 1 or 2, GO to <b>B7</b> . If the Battery Module Diagnostic Test integer value is 4 or 5, GO to <b>B3</b> . If the Battery Module Diagnostic Test integer value is 3, REFER to the Lead-Acid Traction Battery, Battery Module Diagnostic Test Integer Values Chart to determine the required action. No = System OK.
<b>B3 CHECK BATTERY MODULE FAULT STATUS</b> <ul style="list-style-type: none"> <li>With key ON, monitor BCM PIDs BTM__1FT thru BTM25FT.</li> <li>Do any of the battery module fault PIDs indicate YES?</li> </ul>	Yes = GO to <b>B4</b> . No = GO to <b>B7</b> .
<b>B4 CHECK VOLTAGE SENSE LINE CIRCUIT BETWEEN BCM AND IN-LINE CONNECTOR FOR OPEN</b> <ul style="list-style-type: none"> <li>Remove the traction battery and connect Traction Battery High-Voltage Lockout and Diagnostic Tool to the traction battery high-voltage two-pin C3994M.</li> </ul> <p> <b>WARNING: The traction battery contains high-voltage components and wiring. High-voltage insulated safety gloves and face shield must be worn when carrying out the following steps. Failure to follow this warning may result in severe personal injury or death.</b></p> <ul style="list-style-type: none"> <li>With key OFF, disconnect BCM high-voltage C1865, C1866 and the appropriate in-line connector for the battery module(s) in question.</li> </ul> <p><b>NOTE:</b> If a single battery module fault PID (with the exception of BTM__1FT and BTM25FT) indicates YES, check the battery module in question for reverse cable polarity. Reinstall (correctly) if necessary. If the cable polarity is OK, GO to <b>B7</b>.</p> <ul style="list-style-type: none"> <li>Measure the resistance of the wire between the BCM high-voltage connector and in-line connector for the indicated battery module fault(s). Use the following information:  <b>Battery Module Faults</b> <ul style="list-style-type: none"> <li>—1: circuit 3089 (LB/W) between in-line C1750M (label A) and pin 4 on BCM C1865</li> <li>—1, 2: circuit 3072 (PK/Y) between in-line C1752M (label C) and pin 10 on BCM C1865</li> <li>—2, 3: circuit 3073 (R/W) between in-line C1751M (label B) and pin 16 on BCM C1865</li> </ul> </li> </ul>	Yes = GO to <b>B5</b> . No = REPLACE high-voltage harness (10B694). GO to <b>B6</b> .

(Continued)

**DIAGNOSIS AND TESTING (Continued)****PINPOINT TEST B: BATTERY PACK/MODULE(S) VOLTAGE OUT OF RANGE**

TEST STEP	ACTION TO TAKE
<p>—3, 4: circuit 3074 (BK/O) between in-line C1752M (label C) and pin 22 on BCM C1865</p> <p>—4, 5: circuit 3075 (Y) between in-line C1751M (label B) and pin 23 on BCM C1865</p> <p>—5, 6: circuit 3076 (Y/W) between in-line C1753M (label D) and pin 24 on BCM C1865</p> <p>—6, 7: circuit 3077 (O/LB) between in-line C1753M (label D) and pin 18 on BCM C1865</p> <p>—7, 8: circuit 3078 (LB/O) between in-line C1754M (label E) and pin 12 on BCM C1865</p> <p>—8, 9: circuit 3079 (W/PK) between in-line C1753M (label D) and pin 6 on BCM C1865</p> <p>—9, 10: circuit 3080 (R/LB) between in-line C1754M (label E) and pin 1 on BCM C1866</p> <p>—10, 11: circuit 3081 (W/R) between in-line C1755M (label F) and pin 11 on BCM C1866</p> <p>—11, 12: circuit 3082 (BK/LG) between in-line C1754M (label E) and pin 21 on BCM C1866</p> <p>—12, 13: circuit 3083 (DG/LG) between in-line C1755M (label F) and pin 31 on BCM C1866</p> <p>—13, 14: circuit 3084 (BK/PK) between in-line C1756M (label G) and pin 32 on BCM C1866</p> <p>—14, 15: circuit 3085 (O/LG) between in-line C1756M (label G) and pin 33 on BCM C1866</p> <p>—15, 16: circuit 3086 (W/P) between in-line C1757M (label H) and pin 23 on BCM C1866</p> <p>—16, 17: circuit 3087 (DG/P) between in-line C1758M (label J) and pin 13 on BCM C1866</p> <p>—17, 18: circuit 3088 (DB/O) between in-line C1759M (label K) and pin 3 on BCM C1866</p> <p>—18, 19: circuit 3090 (P) between in-line C1758M (label J) and pin 4 on BCM C1866</p> <p>—19, 20: circuit 3091 (LB/BK) between in-line C1749M (label L) and pin 5 on BCM C1866</p> <p>—20, 21: circuit 3092 (GY/O) between in-line C1758M (label J) and pin 15 on BCM C1866</p> <p>—21, 22: circuit 3093 (W/LB) between in-line C1759M (label K) and pin 25 on BCM C1866</p> <p>—22, 23: circuit 3094 (LB/R) between in-line C1749M (label L) and pin 35 on BCM C1866</p> <p>—23, 24: circuit 3095 (O/Y) between in-line C1748M (label M) and pin 36 on BCM C1866</p> <p>—24, 25: circuit 3096 (W) between in-line C1748M (label M) and pin 26 on BCM C1866</p> <p>—25: circuit 3097 (R/LG) between in-line C1747M (label N) and pin 16 on BCM C1866</p> <p>• <b>Is the resistance less than 5 ohms?</b></p>	
<p><b>B5 CHECK VOLTAGE SENSE LINE CIRCUIT BETWEEN BATTERY MODULE AND IN-LINE CONNECTOR FOR OPEN</b></p> <p>• Measure the resistance between the wire on the in-line connector and battery module post (+ or -) for the indicated battery module fault(s). Use the following information:</p>	<p>Yes = GO to <b>B7</b>.</p>



(Continued)

**DIAGNOSIS AND TESTING (Continued)****PINPOINT TEST B: BATTERY PACK/MODULE(S) VOLTAGE OUT OF RANGE**

TEST STEP	ACTION TO TAKE
<p><b>Battery Module Faults</b></p> <ul style="list-style-type: none"> <li>—1: between circuit 3089 (LB/W) on in-line C1750F (label A) and battery module 1 (-) post</li> <li>—1, 2: between circuit 3072 (PK/Y) on in-line C1752F (label C) and battery module 1 (+) post</li> <li>—2, 3: between circuit 3073 (R/W) on in-line C1751F (label B) and battery module 2 (+) post</li> <li>—3, 4: between circuit 3074 (BK/O) on in-line C1752F (label C) and battery module 3 (+) post</li> <li>—4, 5: between circuit 3075 (Y) on in-line C1751F (label B) and battery module 4 (+) post</li> <li>—5, 6: between circuit 3076 (Y/W) on in-line C1753F (label D) and battery module 5 (+) post</li> <li>—6, 7: between circuit 3077 (O/LB) on in-line C1753F (label D) and battery module 6 (+) post</li> <li>—7, 8: between circuit 3078 (LB/O) on in-line C1754F (label E) and battery module 7 (+) post</li> <li>—8, 9: between circuit 3079 (W/PK) on in-line C1753F (label D) and battery module 8 (+) post</li> <li>—9, 10: between circuit 3080 (R/LB) on in-line C1754F (label E) and battery module 9 (+) post</li> <li>—10, 11: between circuit 3081 (W/R) on in-line C1755F (label F) and battery module 10 (+) post</li> <li>—11, 12: between circuit 3082 (BK/LG) on in-line C1754F (label E) and battery module 11 (+) post</li> <li>—12, 13: between circuit 3083 (Y/W) on in-line C1755F (label F) and battery module 12 (+) post</li> <li>—13, 14: between circuit 3084 (BK/PK) on in-line C1756F (label G) and battery module 13 (+) post</li> <li>—14, 15: between circuit 3085 (O/LG) on in-line C1756F (label G) and battery module 14 (+) post</li> <li>—15, 16: between circuit 3086 (W/P) on in-line C1757F (label H) and battery module 15 (+) post</li> <li>—16, 17: between circuit 3087 (DG/P) on in-line C1758F (label J) and battery module 16 (+) post</li> <li>—17, 18: between circuit 3088 (DB/O) on in-line C1759F (label K) and battery module 17 (+) post</li> <li>—18, 19: between circuit 3090 (P) on in-line C1758F (label J) and battery module 18 (+) post</li> <li>—19, 20: between circuit 3091 (LB/BK) on in-line C1749F (label L) and battery module 19 (+) post</li> <li>—20, 21: between circuit 3092 (GY/O) on in-line C1758F (label J) and battery module 20 (+) post</li> <li>—21, 22: between circuit 3093 (W/LB) on in-line C1759F (label K) and battery module 21 (+) post</li> <li>—22, 23: between circuit 3094 (LB/R) on in-line C1749F (label L) and battery module 22 (+) post</li> <li>—23, 24: between circuit 3095 (O/Y) on in-line C1748F (label M) and battery module 23 (+) post</li> </ul>	<p>No = REPLACE the harness(es) (14A280) in question. GO to <b>B6</b>.</p>

(Continued)

**DIAGNOSIS AND TESTING (Continued)****PINPOINT TEST B: BATTERY PACK/MODULE(S) VOLTAGE OUT OF RANGE**

TEST STEP	ACTION TO TAKE
<p>—24, 25: between circuit 3096 (W) on in-line C1748F (label M) and battery module 24 (+) post</p> <p>—25: between circuit 3097 (R/LG) on in-line C1747F (label N) and battery module 25 (+) post</p> <ul style="list-style-type: none"> <li>• Is the resistance between 28,000 and 34,000 ohms?</li> </ul>	
<p><b>B6 CHECK OPEN CIRCUIT VOLTAGE OF BATTERY MODULE</b></p> <ul style="list-style-type: none"> <li>• Measure the voltage of the battery module(s) in question.</li> <li>• Is the voltage less than 10.5 volts?</li> </ul>	<p>Yes = GO to <b>B7</b>.</p> <p>No = Battery module OK.</p>
<p><b>B7 INPUT BATTERY MODULE DATA</b></p> <ul style="list-style-type: none"> <li>• Remove the traction battery (if necessary) and connect Traction Battery High-Voltage Lockout and Diagnostic Tool to the traction battery high-voltage two-pin C3994M.</li> <li>• Connect Traction Battery High-Voltage Service Cord to traction battery support tray in-line C1935F and in-line C1935M.</li> </ul> <p> <b>WARNING: The traction battery contains high-voltage components and wiring. High-voltage insulated safety gloves and face shield must be worn when carrying out the following steps. Failure to follow this warning may result in severe personal injury or death.</b></p> <ul style="list-style-type: none"> <li>• Connect Traction Battery Low-Voltage Service Cord to traction battery support tray in-line C1939F and in-line C1939M.</li> <li>• With key ON, monitor BCM PIDs BAT__MC, CHG__CYC, and LOWVOLT and enter the values on the Dealer Battery Return Form that is packaged with the new battery module.</li> <li>• Fill out all the required data on the Dealer Battery Return Form and return the form with the damaged battery module.</li> <li>• Is the correct data entered on the Dealer Battery Return Form?</li> </ul>	<p>Yes = REPLACE the battery module(s) in question.</p> <p>No = ENTER the indicated data. REPLACE the battery module(s) in question.</p>
<p><b>B8 CHECK TRACTION BATTERY POSITIVE (+) SENSE LINE CIRCUIT 3214 (LB) BETWEEN BCM AND IN-LINE C1747M FOR OPEN</b></p> <ul style="list-style-type: none"> <li>• Remove the traction battery and connect Traction Battery High-Voltage Lockout and Diagnostic Tool to the traction battery high-voltage two-pin C3994M.</li> <li>• Connect Traction Battery High-Voltage Service Cord to traction battery support tray in-line C1935F and in-line C1935M.</li> </ul> <p> <b>WARNING: The traction battery contains high-voltage components and wiring. High-voltage insulated safety gloves and face shield must be worn when carrying out the following steps. Failure to follow this warning may result in severe personal injury or death.</b></p> <ul style="list-style-type: none"> <li>• Connect Traction Battery Low-Voltage Service Cord to traction battery support tray in-line C1939F and in-line C1939M.</li> <li>• With key OFF, disconnect BCM high-voltage C1866.</li> <li>• With key OFF, disconnect in-line C1747 (label N) and measure the resistance of the LB wire between pin 30 on BCM high-voltage C1866 and in-line C1747M.</li> <li>• Is the resistance less than 5 ohms?</li> </ul>	<p>Yes = GO to <b>B9</b>.</p> <p>No = REPLACE high-voltage harness (10B694).</p>
<p><b>B9 CHECK TRACTION BATTERY POSITIVE (+) SENSE LINE CIRCUIT BETWEEN IN-LINE C1747F AND BATTERY MODULE 25 FOR OPEN</b></p> <ul style="list-style-type: none"> <li>• With key OFF, measure the resistance between the LB wire on in-line C1747F and battery module 25 positive (+) post.</li> </ul>	<p>Yes = GO to <b>B10</b>.</p>

(Continued)

**DIAGNOSIS AND TESTING (Continued)****PINPOINT TEST B: BATTERY PACK/MODULE(S) VOLTAGE OUT OF RANGE**

TEST STEP	ACTION TO TAKE
<ul style="list-style-type: none"> <li>Is the resistance between 28,000 and 34,000 ohms?</li> </ul>	No = REPLACE high-voltage harness (14A280-NC).
<b>B10 CHECK TRACTION BATTERY NEGATIVE (-) SENSE LINE CIRCUIT 3215 (PK/BK) BETWEEN BCM AND IN-LINE C1750M FOR OPEN</b> <ul style="list-style-type: none"> <li>With key OFF, disconnect BCM high-voltage C1865 and in-line C1750 (label A).</li> <li>With key OFF, measure the resistance of the PK/BK wire between pin 1 on BCM high-voltage C1865 and in-line C1750M.</li> <li>Is the resistance less than 5 ohms?</li> </ul>	Yes = GO to <b>B11</b> . No = REPLACE high-voltage harness (10B694).
<b>B11 CHECK TRACTION BATTERY NEGATIVE (-) SENSE LINE CIRCUIT BETWEEN IN-LINE C1750F AND BATTERY MODULE 1 FOR OPEN</b> <ul style="list-style-type: none"> <li>With key OFF, measure the resistance between the PK/BK wire on in-line C1750F and battery module 1 positive (+) post.</li> <li>Is the resistance between 28,000 and 34,000 ohms?</li> </ul>	Yes = GO to <b>B12</b> . No = REPLACE high-voltage harness (14A280-AB).
<b>B12 CHECK FOR INTERMITTENT CONCERN(S)</b> <ul style="list-style-type: none"> <li>With key OFF, reconnect in-line C1747 (label N), in-line C1750 (label A), and BCM high-voltage C1865 and C1866.</li> <li>Carry out the on-demand self-test for the BCM.</li> <li>Does DTC C1676 Battery Pack Voltage Out of Range occur?</li> </ul>	Yes = REPLACE the BCM. No = System OK.

**PINPOINT TEST C: DTC C1864 BATTERY MODULE FAULT**

TEST STEP	ACTION TO TAKE
<b>C1 CHECK STATUS OF BATTERY PACK</b> <ul style="list-style-type: none"> <li>With key ON, monitor battery control module (BCM) PIDs REV__BAT and WRG__BCM.</li> <li>Do either of the PIDs indicate YES?</li> </ul>	Yes = If PID REV__BAT indicates YES, GO to <b>C2</b> . If PID WRG__BCM indicates YES, GO to <b>C4</b> . No = System OK.
<b>C2 CHECK BATTERY MODULE FAULT STATUS</b> <ul style="list-style-type: none"> <li>With key ON, monitor BCM PIDs BTM__1FT through BTM25FT.</li> <li>Do any of the battery module faults indicate YES?</li> </ul>	Yes = REMOVE the traction battery (if necessary) and REINSTALL (correctly) the battery module for the BTM__FT that indicates YES. The battery module has been incorrectly (reverse cable polarity) installed. No = GO to <b>C3</b> .
<b>C3 CHECK STATUS OF BATTERY CONTROL MODULE (BCM) OPERATING STATE AFTER POWER RESET</b> <ul style="list-style-type: none"> <li>Disconnect the 12-volt auxiliary battery negative cable.</li> <li>Wait 30 seconds.</li> <li>Reconnect the 12-volt auxiliary battery negative cable.</li> <li>With key ON, monitor BCM PID BCM__OP.</li> <li>Does the BCM__OP PID indicate 50 (battery module reversed)?</li> </ul>	Yes = REPLACE the BCM. No = System OK.
<b>C4 CHECK FOR WRONG BCM INSTALLATION</b> <ul style="list-style-type: none"> <li>Verify the BCM and battery pack are NiMH.</li> <li>Are the BCM and battery pack NiMH?</li> </ul>	Yes = REPLACE the BCM. No = INSTALL the correct BCM.



**DIAGNOSIS AND TESTING (Continued)****PINPOINT TEST D: DTC B2236 WEAK OR DEFECTIVE ELECTRIC VEHICLE BATTERY MODULE FAULT**

TEST STEP	ACTION TO TAKE
<p><b>D1 CHECK STATUS OF TRACTION BATTERY MODULES BY CARRYING OUT THE BATTERY MODULE DIAGNOSTIC TEST</b></p> <p><b>NOTE:</b> If DTC B1671 Battery Module Voltage Out of Range occurs along with DTC B2236, do NOT carry out this test step. Go to Pinpoint Test B.</p> <ul style="list-style-type: none"> <li>With key ON, perform Battery Module Diagnostic Test. Refer to the procedure in Traction Battery System.</li> <li><b>Does the Battery Module Diagnostic Test indicate to replace any battery modules?</b></li> </ul>	<p>Yes = REPAIR as indicated.</p> <p>No = System OK.</p>

**PINPOINT TEST E: BATTERY PACK/MODULE VERIFICATION TEST**

TEST STEP	ACTION TO TAKE
<p><b>E1 CARRY OUT THE DIAGNOSTIC PROCESS</b></p> <p><b>NOTE:</b> Verify the power control station (PCS) charger cord is not plugged into the charger inlet before carrying out this test step.</p> <p><b>NOTE:</b> Disregard traction inverter module (TIM) DTC C1862 Contactor Circuit Failure when carrying out the Diagnostic Process for this test step. DTC C1862 occurs due to the connection of the Traction Battery High-Voltage Lockout and Diagnostic Tool to the traction battery high-voltage two-pin connector C3994M.</p> <ul style="list-style-type: none"> <li>Carry out the Diagnostic Process. Refer to Section 100-07.</li> <li><b>Do any DTCs occur?</b></li> </ul>	<p>Yes = REFER to the appropriate Diagnostic Trouble Code  (DTC) Index in Section 100-07.</p> <p>No = GO to <b>E2</b>.</p>
<p><b>E2 CHECK INSTRUMENT CLUSTER INDICATORS</b></p> <ul style="list-style-type: none"> <li>With key ON, check to see if the following instrument cluster indicators are illuminated: <ul style="list-style-type: none"> <li>—Malfunction indicator lamp (MIL)</li> <li>—Power limit warning indicator</li> <li>—Red brake warning indicator</li> <li>—Low state of charge (SOC) indicator</li> <li>—Auxiliary battery indicator</li> <li>—Electrical hazard warning indicator (may or may not illuminate)</li> </ul> </li> <li><b>Do all the instrument cluster indicators listed above illuminate?</b></li> </ul>	<p>Yes = GO to <b>E3</b></p> <p>No = REFER to the Powertrain Diagnostic Routines Index in Section 100-09.</p>
<p><b>E3 CHARGE TRACTION BATTERY TO FULL STATE OF CHARGE (SOC)</b></p> <p><b>NOTE:</b> Clear the continuous diagnostic trouble codes (DTCs) from the battery control module (BCM) before connecting the vehicle to a PCS.</p> <ul style="list-style-type: none"> <li>Disconnect the 12-volt auxiliary battery negative cable.</li> <li>Wait approximately 30 seconds and reconnect the auxiliary battery negative cable.</li> <li>Connect the vehicle to the PCS and press the START button to begin charging.</li> <li>With vehicle on-charge, monitor BCM PID BCM__OP.</li> <li>Note the BCM__OP PID numeric value and refer to the BCM Operating State Index in Section 100-07 to determine the BCM operating state.</li> <li><b>Does the BCM__OP PID indicate any no-charge conditions?</b></li> </ul>	<p>Yes = REFER to Powertrain Diagnostic Routines Index in Section 100-09.</p> <p>No = CHARGE traction battery to full SOC. Test complete.</p>

**DIAGNOSIS AND TESTING (Continued)****Multiple Auxiliary Load Failure  
Diagnosis****Inspection and Verification**Refer to [Section 100-07](#).**Electrical Schematic**

Refer to Electrical and Vacuum Troubleshooting Manual, Cell 13, Power Distribution (High-Voltage) for schematic and connector information.

**Symptom Chart****Symptom Chart**

Condition	Possible Sources	Action
<ul style="list-style-type: none"> <li>All High-Voltage Auxiliary Load Systems Do Not Operate</li> </ul>	<ul style="list-style-type: none"> <li>High-voltage harness (14B326).</li> <li>High voltage power distribution box (HVPDB).</li> <li>Contacto box.</li> </ul>	<ul style="list-style-type: none"> <li>GO to Pinpoint Test A.</li> </ul>

**Pinpoint Tests****Special Tool(s)**

Traction Battery High-Voltage Service Cord 418-F218

**PINPOINT TEST A: ALL HIGH-VOLTAGE AUXILIARY LOAD SYSTEMS DO NOT OPERATE**

TEST STEP	ACTION TO TAKE
<b>A1 VERIFY ALL HIGH-VOLTAGE AUXILIARY LOAD SYSTEMS DO NOT OPERATE</b> <ul style="list-style-type: none"> <li>With key ON, turn the steering wheel. If there is no power assist, the power steering system does not operate.</li> <li>With key ON, measure the voltage of the 12-volt auxiliary battery. The voltage should be greater than 13 volts.</li> <li>With key ON, operate the heater and air conditioner (if equipped).</li> <li><b>Do all the high-voltage auxiliary load systems operate?</b></li> </ul>	Yes = System OK. CHECK wiring for intermittent connections. No = If none of the high-voltage auxiliary load systems operate, GO to A2. If some of the high-voltage auxiliary load systems operate, REFER to the appropriate section(s) for the system(s) in question.
<b>A2 CHECK HIGH-VOLTAGE NEGATIVE BUS (OUTSIDE TRACTION BATTERY SUPPORT TRAY) FOR OPEN</b> <ul style="list-style-type: none"> <li>With key OFF, disconnect high-voltage auxiliary load in-line C1935 on the traction battery support tray and power steering assembly high-voltage C1895.</li> <li>Measure the resistance between circuit 3141 (W wire) on power steering assembly C1895 and circuit 3133 (W wire) on high-voltage auxiliary load in-line C1935M.</li> <li><b>Is the resistance less than 5 ohms?</b></li> </ul>	Yes = GO to A3. No = REPLACE the high voltage power distribution box (HVPDB).
<b>A3 CHECK HIGH-VOLTAGE NEGATIVE BUS (INSIDE TRACTION BATTERY SUPPORT TRAY) FOR OPEN</b> <ul style="list-style-type: none"> <li>Remove the traction battery.</li> </ul>	Yes = REPLACE the contactor box.

(Continued)

**DIAGNOSIS AND TESTING (Continued)**



**PINPOINT TEST A: ALL HIGH-VOLTAGE AUXILIARY LOAD SYSTEMS DO NOT OPERATE**

TEST STEP	ACTION TO TAKE
<p><b>⚠ WARNING:</b> The traction battery contains high-voltage components and wiring. High-voltage insulated safety gloves and face shield must be worn when carrying out the following steps. Failure to follow this warning may result in severe personal injury or death.</p> <ul style="list-style-type: none"> <li>Connect Traction Battery High-Voltage Service Cord to high-voltage auxiliary load in-line C1935F on the traction battery support tray and in-line C1935M.</li> </ul> <p><b>NOTE:</b> Contactor box C3985 is mounted on the passenger side of the BCM.</p> <ul style="list-style-type: none"> <li>With key OFF, disconnect contactor box C3985 and measure the voltage between the R wire on contactor box C3985 and chassis ground.</li> <li>Is the voltage greater than 10 volts?</li> </ul>	<p>No = REPLACE high-voltage harness 14B326 between traction battery support tray in-line C1935F and contactor box C3985.</p>

**GENERAL PROCEDURES**

**Traction Battery Module Replacement**

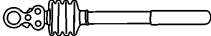
**Special Tool(s)**

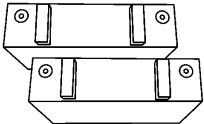
 <p>ST2097-A</p>	<p>Battery Post Torque Wrench 307-026</p>
 <p>ST2091-A</p>	<p>Battery Terminal Cap Opener 418-F215</p>
 <p>ST2092-B</p>	<p>In-Line Bypass Battery Module 418-F210</p>

(Continued)

**Special Tool(s)**

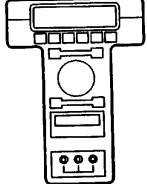
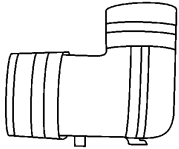
 <p>ST1217-A</p>	<p>New Generation STAR (NGS) Tester or equivalent 418-F048 (007-00500)</p>
 <p>ST2090-A</p>	<p>Traction Battery High-Voltage Lockout and Diagnostic Tool 418-F207</p>

(Continued)

**GENERAL PROCEDURES (Continued)****Special Tool(s)**

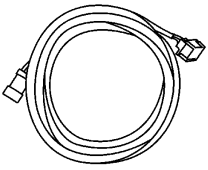
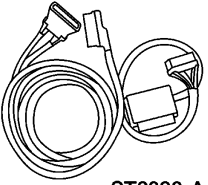
 <p>ST2094-A</p>	<p>Traction Battery High-Voltage Service Cord 418-F218</p>
 <p>ST2093-A</p>	<p>Traction Battery Low-Voltage Service Cord 418-F219</p>

**Module Replacement**

1. If necessary, charge all new replacement battery modules prior to installation. Refer to Module Charging to determine battery module charging conditions.
2. With the key ON, enter battery control module (BCM) active command mode RESET HISTORICAL DATA and set the active command RESET to the battery module(s) that were replaced.
3. **NOTE:** If more than two battery modules need to be replaced, do not replace the traction battery cover or install the traction battery at the end of the procedure. Repeat the battery module removal and installation process until all battery modules have been replaced. Only two battery modules can be replaced at a time, as there are only two In-Line Bypass Battery Modules in the special service tool kit.

**NOTE:** Position the vehicle near a charging station before beginning the procedure.

Remove the traction battery. Refer to **Traction Battery**.

## GENERAL PROCEDURES (Continued)

4.  **WARNING:** The nominal voltage of the traction battery is 300 volts. The buffer zone must be set up and insulated rubber gloves and a face shield must be worn. Failure to follow these precautions may result in severe personal injury or death.

Observe the EV-specific precautions. Refer to [Section 100-00](#).

- 1 Set up the buffer zone.
- 2 Test and wear the insulated rubber gloves.
- 3 Wear the face shield.

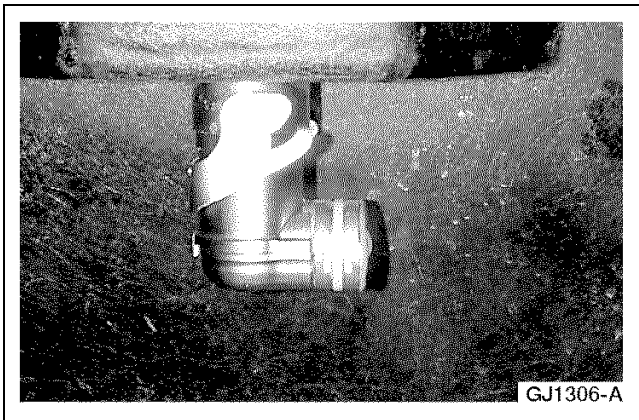

5. **NOTE:** The Traction Battery High-Voltage Lockout and Diagnostic Tool connects to the two-pin high-voltage connector located at the rear of the traction battery.

Install the Traction Battery High-Voltage Lockout and Diagnostic Tool.

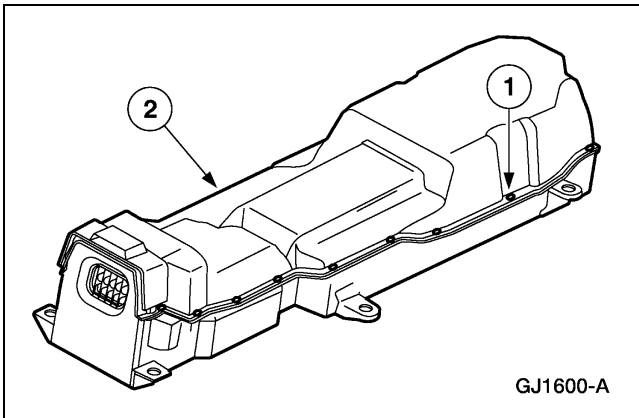

6. Remove the traction battery cover.
  - 1 Remove the 22 bolts.
  - 2 Remove the cover.

7. Check the specific battery module number procedure for specific removal information. The battery modules are grouped as follows: 2-6; 1, 7, 8, 9, 25; 10, 11, 12, 23, 24; 13-15; 16, 19, 20, 22; and 17, 18, 21. Refer to the specific Traction Battery Module procedure.

## GENERAL PROCEDURES (Continued)

8. **NOTE:** Do not replace more than 4 battery modules. If more than 4 battery modules need to be replaced, replace all 25 battery modules. Enter the indicated data on the Battery Module Replacement Data Form. The form is located on the Electric Ranger Service Card that is inside the traction battery support tray. If more than 4 modules need to be replaced, all of the modules in the pack must be replaced. Refer to Traction Battery Disassembly and Assembly.

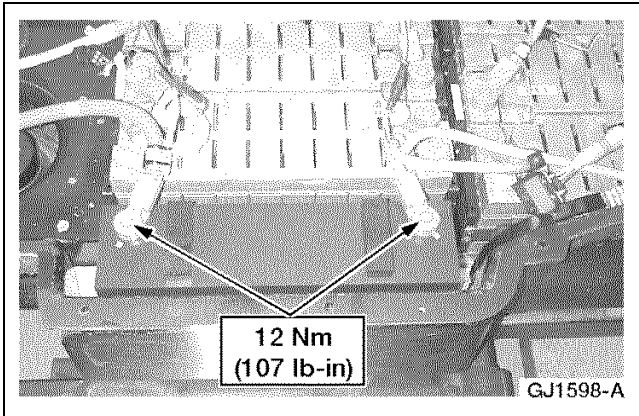

9. Replace the battery module(s) that were removed with the in-line bypass battery module(s) and install the nuts.

10. Replace any components that were removed to gain access to the battery module(s) that were replaced. The traction battery must be assembled prior to charging. The battery modules are grouped as follows: 2-6; 1, 7, 8, 9, 25; 10, 11, 12, 23, 24; 13-15; 16, 19, 20, 22; and 17, 18, 21. Refer to the specific Traction Battery Module procedure.

11. Position the removed traction battery next to the vehicle with the 76-pin connector and the auxiliary load high-voltage connector toward the front of the vehicle.

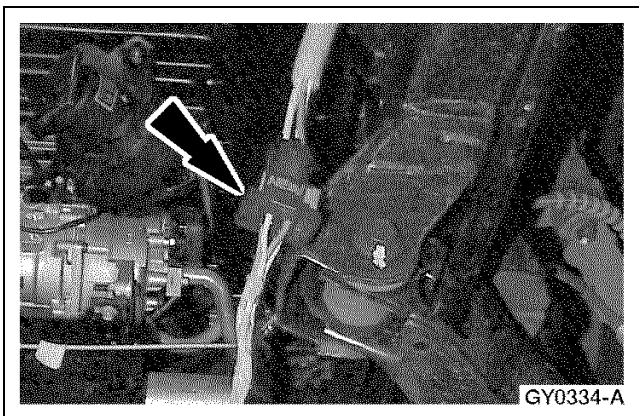

12. Connect the Traction Battery High-Voltage Service Cord to the auxiliary load high-voltage connector on the vehicle.

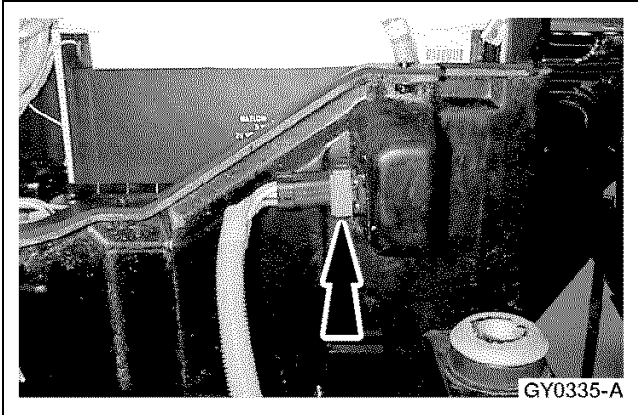
**GENERAL PROCEDURES (Continued)**

13. Connect the Traction Battery High-Voltage Service Cord to the traction battery auxiliary load high-voltage connector on the traction battery.

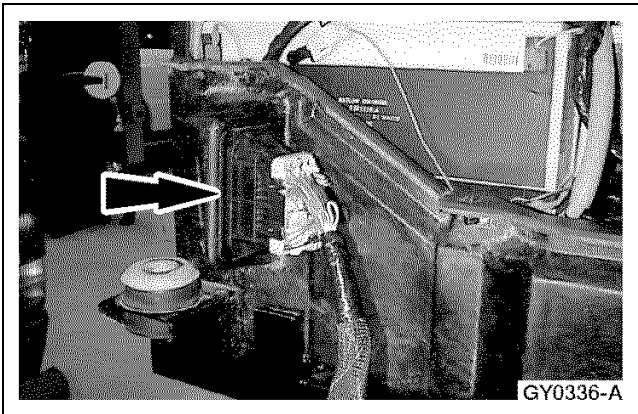

14. Connect the Traction Battery Low-Voltage Service Cord to the 76-pin low-voltage connector on the traction battery.
  - Loosely install the bolt.

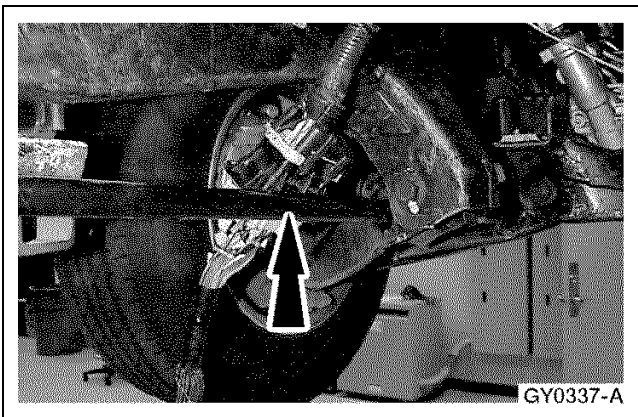

15. Connect the Traction Battery Low-Voltage Service Cord to the 76-pin low-voltage connector on the vehicle.
  - Loosely install the bolt.

16. Charge the traction battery to a full state of charge (SOC). Refer to [Section 100-05](#).

## GENERAL PROCEDURES (Continued)

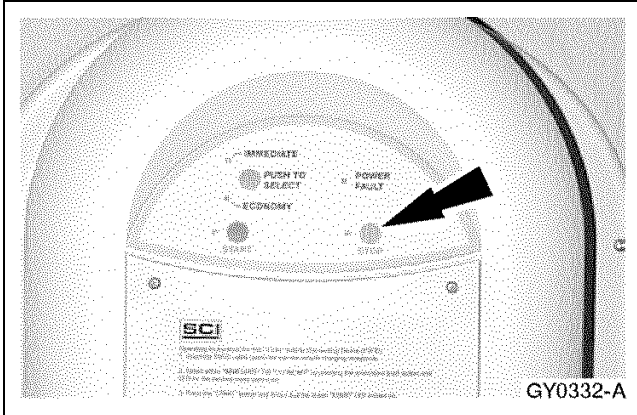

17. After charging has been completed, press the button to deactivate the power control station (PCS).

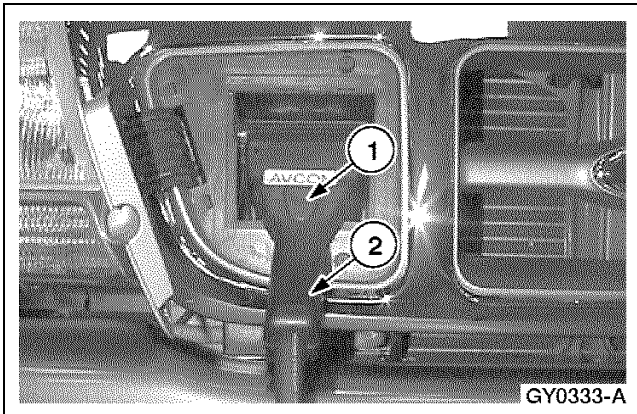

18. Disconnect the PCS from the charger inlet connector.
  - 1 Press and hold the release button.
  - 2 Lift and disconnect the PCS from the charger inlet connector.

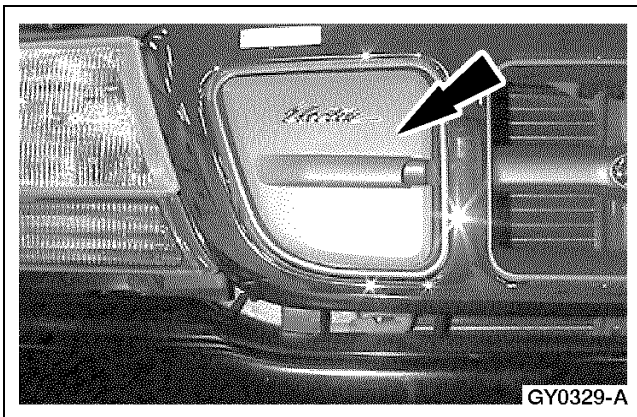

19. Close the charge inlet access door.

20. Enter the indicated data on the Dealer Battery Return Form that is packaged with the new battery module.
21. Remove the In-Line Bypass Battery Module(s) and replace it with a freshly charged battery module(s). Assemble the traction battery. Check the specific battery module number procedure for specific removal information. The battery modules are grouped as follows: 2-6; 1, 7, 8, 9, 25; 10, 11, 12, 23, 24; 13-15; 16, 19, 20, 22; and 17, 18, 21. Refer to the specific Traction Battery Module procedure.



**GENERAL PROCEDURES (Continued)**

22. Connect New Generation STAR (NGS) Tester to the vehicle.
23. Remove the NGS Tester and charge the traction battery to full SOC. Refer to [Section 100-05](#).
24. Perform Battery Pack/Module Verification Test. Refer to Diagnosis and Testing for Traction Battery System in this section.
25. Disconnect the Traction Battery High-Voltage Service Cord from the auxiliary load high-voltage connector on the vehicle.

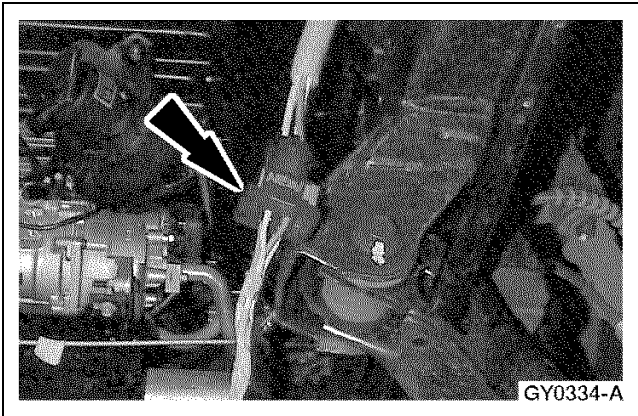

26. Disconnect the Traction Battery High-Voltage Service Cord from the traction battery auxiliary load high-voltage connector on the traction battery.

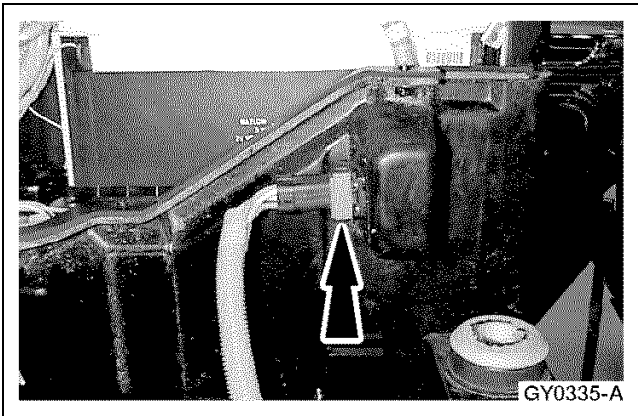

27. Disconnect the Traction Battery Low-Voltage Service Cord from the 76-pin low-voltage connector on the traction battery.

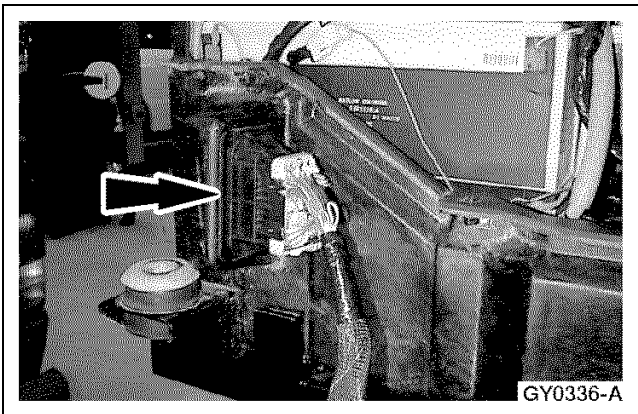

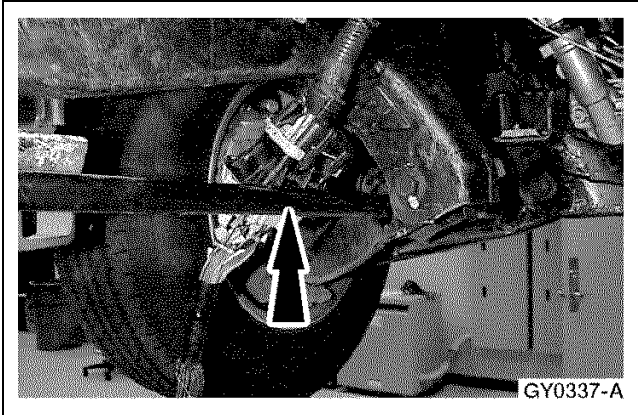
**GENERAL PROCEDURES (Continued)**

28. Disconnect the Traction Battery Low-Voltage Service Cord from the 76-pin low-voltage connector on the vehicle.

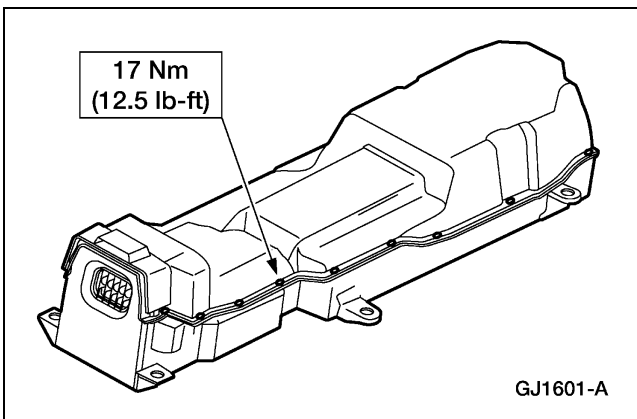

29. Apply Loctite 242 (threadlock and sealer) to the 22 traction battery cover bolts.

30. Install the traction battery cover.
  - Install the 22 bolts.

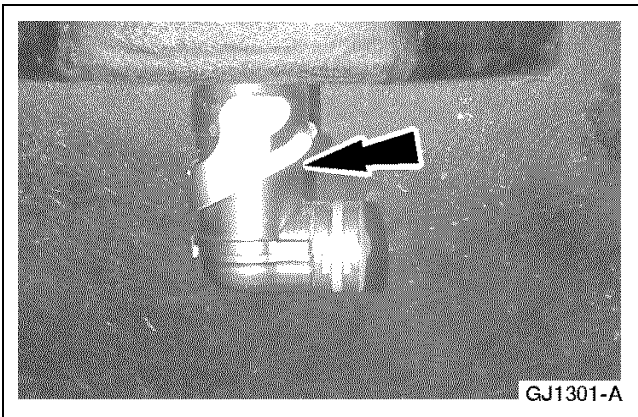

31. Remove the Traction Battery High-Voltage Lockout and Diagnostic Tool.

32. Install the traction battery. Refer to [Traction Battery](#).

**GENERAL PROCEDURES (Continued)**

**Traction Battery Tray Repair**

**Battery Tray**

	Battery hold downs	1
	Battery tray	2
	Brackets	3

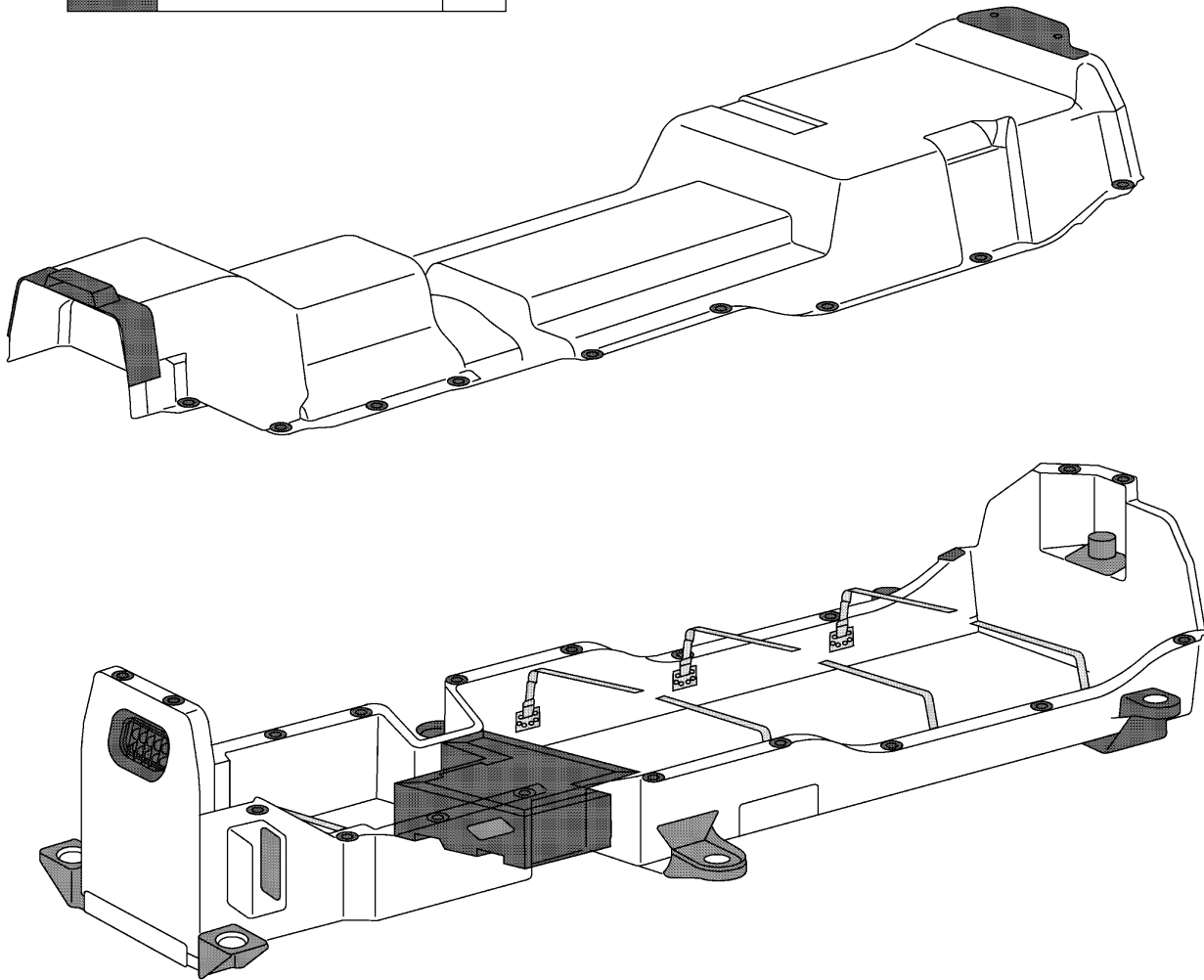

GJ1602-A

## GENERAL PROCEDURES (Continued)

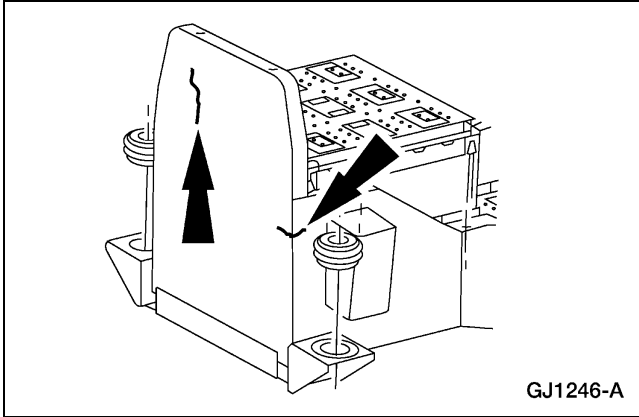

1. **NOTE:** The battery case consists of three main elements: composite enclosure, metal brackets, battery locators, and a battery tray seal. The repair method differs based on what element is affected.

**NOTE:** The composite enclosure is a resin transfer molded (RTM) glass-reinforced thermoset plastic with an integral foam core.

A minor resin split or scratch on the surface of the composite enclosure does not need to be repaired and will not affect the performance of the traction battery case. A resin split can be found on the radii or in smooth high gloss areas.

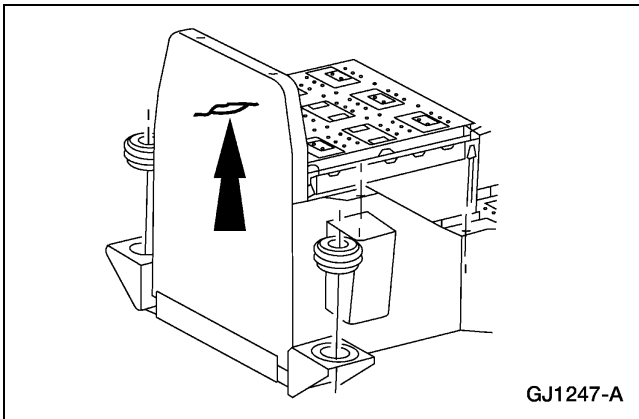

2. **NOTE:** A crack in the composite enclosure is more significant than a resin split and requires repair or replacement of the battery tray. A crack can be identified as a surface that is separated or crushed exposing glass fiber ends or foam core.

A crack in the composite enclosure less than 25 mm (1 in) in length can also be repaired. If the crack is longer than 25 mm (1 in), or the damage passes all the way through the case, the battery case must be replaced.

3. A scratch or split on the surface of the composite enclosure does not need to be repaired and will not affect the performance of the traction battery. If the damage is visible, it can be blended into the surrounding surface by lightly sanding the area.

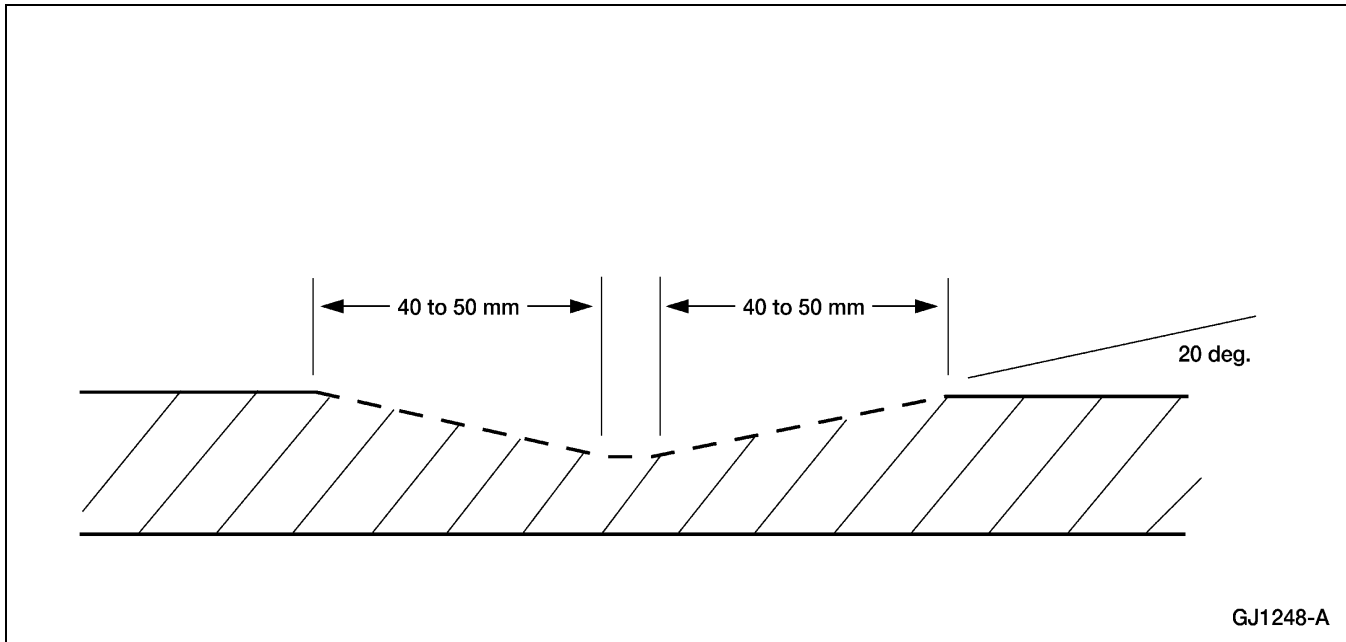
**GENERAL PROCEDURES (Continued)**

4. To repair cracks less than 25 mm (1 in) in length, clean the area surrounding the damage prior to repair. After cleaning, grind a 20 degree bevel extending 40 to 50 mm (1.57 to 2 in) around the damage.

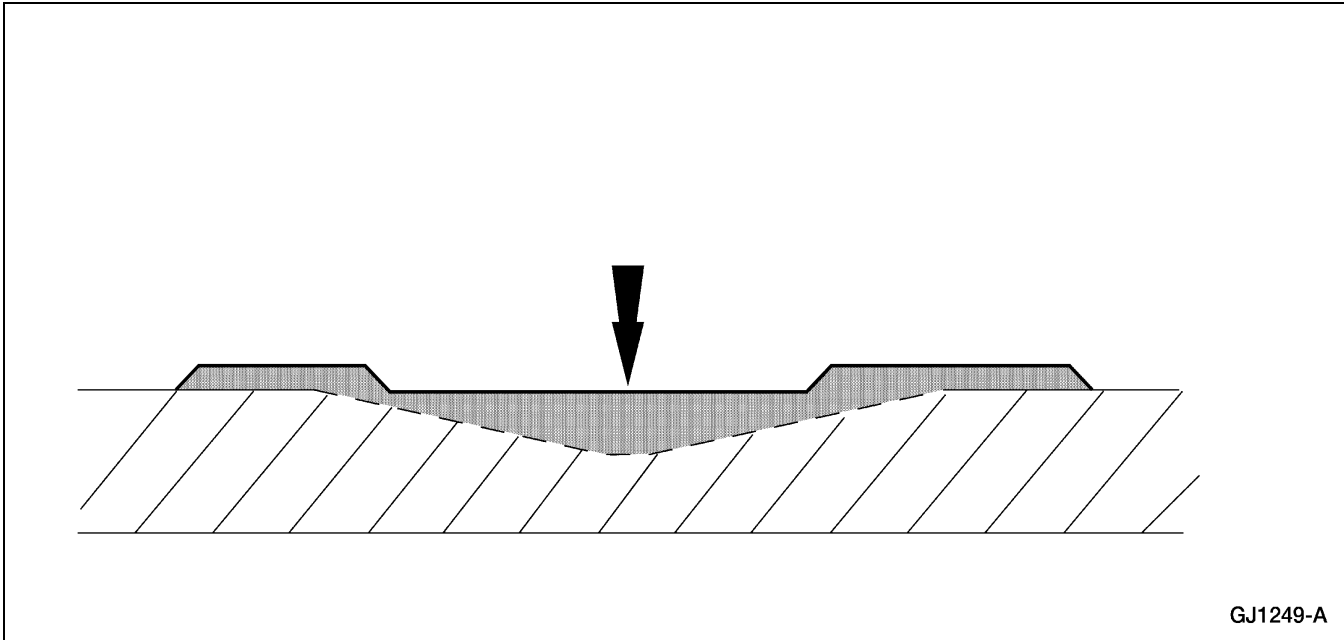
**GENERAL PROCEDURES (Continued)**

5. Immediately after grinding, apply the repair patch. Cut a piece of glass mat that will extend 25 mm (1 in) beyond the damaged area. Prepare a mixture of vinyl ester resin and soak the glass mat in it. Lay the resin soaked glass mat over the damaged area and smooth out the patch using a spreader. The patch should lay on the surface of the composite member as illustrated.
6. Allow the patched area to cure for at least 1.5 to 2 hours at 24°C (75°F). Curing will take longer at colder temperatures. A heat lamp placed no less than 45 cm (18 in) from the repair for approximately 15 minutes will help decrease cure time. After the patch has cured, grind the repair until it is flush with the surrounding area.
7. Seal repaired area with catalyzed resin and a thin ply of glass. Allow the surface resin to cure 1.5 to 2 hours at 24°C (75°F). Blend the repaired area to the surrounding material.

**Metal Bracket Replacement**

1. Make locating marks to indicate the position of the damaged bracket or locator.

---

**GENERAL PROCEDURES (Continued)**

2. Remove the damaged bracket or locator using a heat gun positioned at least 150 mm (6 in) from the part being removed. The gun will heat the adhesive and allow the part to be removed. Keep the gun moving over the part in order to prevent exposing the composite material to excessive heat. Once the adhesive softens, the part can be removed and discarded.
3. Scrape and sand off all of the remaining adhesive. The surface must be clean and roughly sanded for correct adhesion.
4. Clean the area with alcohol.
5. Prepare a mixture of Pilogrip urethane adhesive and apply it to the bonding area.
6. Position a new bracket. The adhesive should be 1-2 mm (.04-.08 in) thick for correct bonding. Do not squeeze out excessive amounts of the adhesive or the bond may fail.
7. Allow the adhesive to cure for 1 hour at 24°C (75°F). After curing, excess adhesive may be trimmed using a sharp knife.

**Battery Tray Seal**

1. **NOTE:** The seal surrounds the entire battery tray to prevent moisture in the battery case. Minor splits or gouges within the seal will not affect the performance of the traction battery. Significant rips or tears require replacement of the seal.  
Remove damaged seal by peeling it away from the battery tray.
2. Scrape away any remaining seal pieces stuck to the battery tray.
3. Clean the area with alcohol.
4. Place the new seal on the battery tray by peeling back the white strip to expose the adhesive. Start at one end of the seal to maintain a good fit.

**GENERAL PROCEDURES (Continued)**

5. Press down continuously along the entire length of the seal to ensure a good bond to the surface of the battery tray.

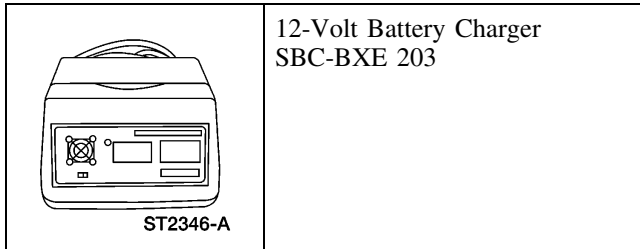
**Module Charging****Special Tool(s)**

1.  **CAUTION: Do not use any charger other than the required SBC-BXE 203 12-Volt Battery Charger.**  
Plug the Battery Charger in and ensure that it is turned OFF.
2. Connect the Battery Charger to the module. Connect the RED lead to the positive terminal and the BLACK lead to the negative terminal on the module. Turn the charger on. A flashing green light on the charger will indicate that the charger is operating and that the module is being charged. During the charging cycle, the charger will produce approximately 14 volts DC.
3. The flashing green light on the charger indicates that the charger is in the charge mode and is working properly. The time that the charger remains in this mode depends on the size and state of charge of the module being charged.
4. When the module reaches 100% state of charge, the green light will steadily illuminate. The steady green light indicates that the charger has completed charging the module.
5. If the green and red lights flash sequentially, the charger to module polarity is incorrect and must be corrected before module charging can begin.



## REMOVAL AND INSTALLATION

### Battery Control Module (BCM)

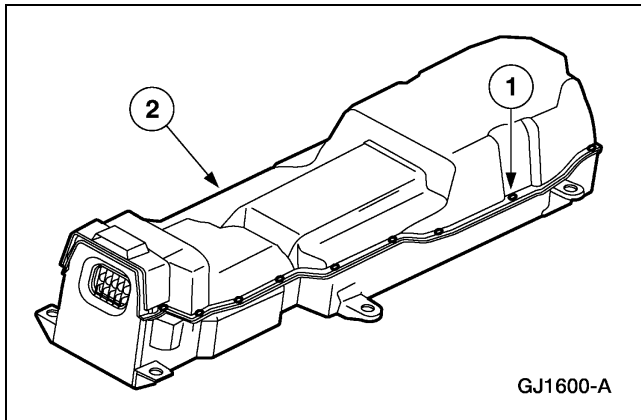

#### Removal

1. Remove the traction battery. Refer to [Traction Battery](#).
2. Remove the traction battery cover.
  - 1 Remove the 22 bolts.
  - 2 Remove the cover.

3. **⚠ WARNING: The nominal voltage of the traction battery is 300 volts. The buffer zone must be set up and insulated rubber gloves and a face shield must be worn. Failure to follow these precautions may result in severe personal injury or death.**

Observe the EV-specific precautions. Refer to [Section 100-00](#).

- 1 Set up the buffer zone.
- 2 Test and wear the insulated rubber gloves.
- 3 Wear the face shield.

4. Disconnect the high-voltage connector.
  - 1 Loosen the bolts.
  - 2 Disconnect the connectors.

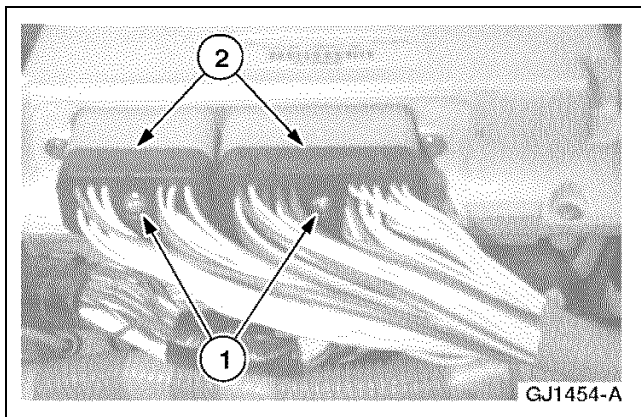

## REMOVAL AND INSTALLATION (Continued)

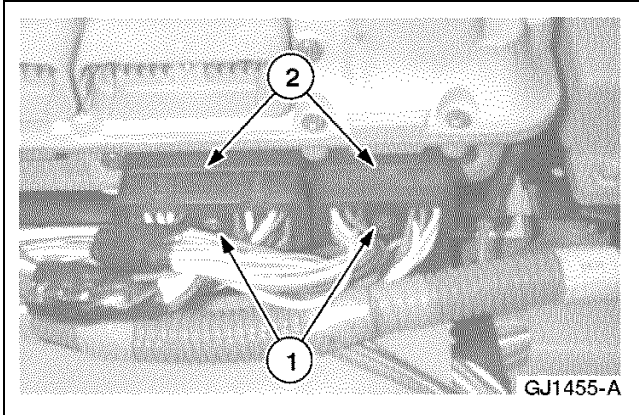

5. Disconnect the low voltage connector.
  - 1 Loosen the bolts.
  - 2 Disconnect the connectors.

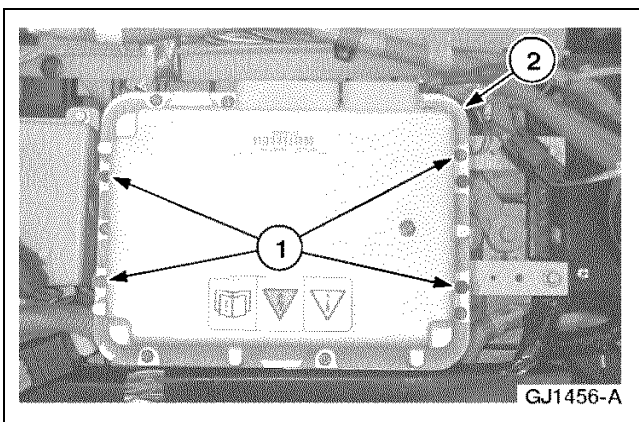

6. Remove the battery control module (BCM).
  - 1 Remove the bolts.
  - 2 Remove the BCM.

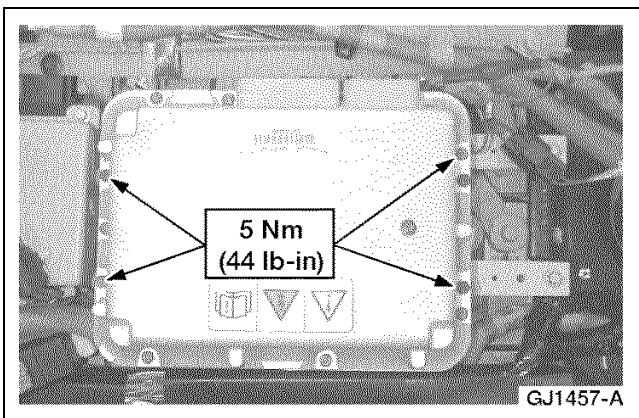

## Installation

1. **⚠ CAUTION: Do not overtighten the BCM multi-pin connectors. Damage to the connectors may occur if overtightened.**  
To install, reverse the removal procedure.
  - Apply Loctite 242 to the 22 traction battery cover bolts.
  - After installation, connect the New Generation STAR (NGS). Turn the ignition key ON. Enter the battery control module (BCM) active command mode RESET HISTORICAL DATA and set the active command RESET to ALL.
  - Remove the NGS and charge the traction battery. Refer to [Section 100-05](#).

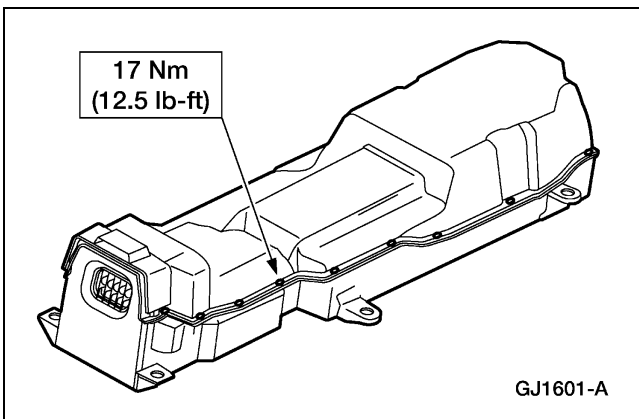
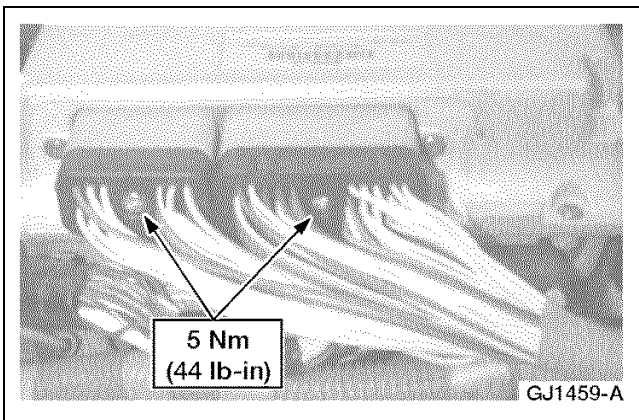
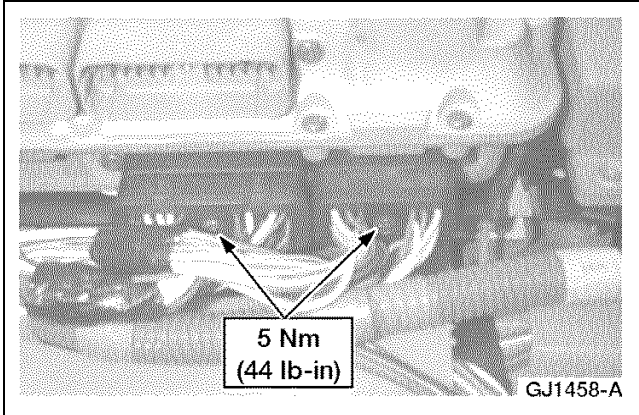
**REMOVAL AND INSTALLATION (Continued)****Charge Inlet****Removal**

1. Disconnect the traction battery auxiliary load high-voltage connector. Refer to [Section 100-05](#).

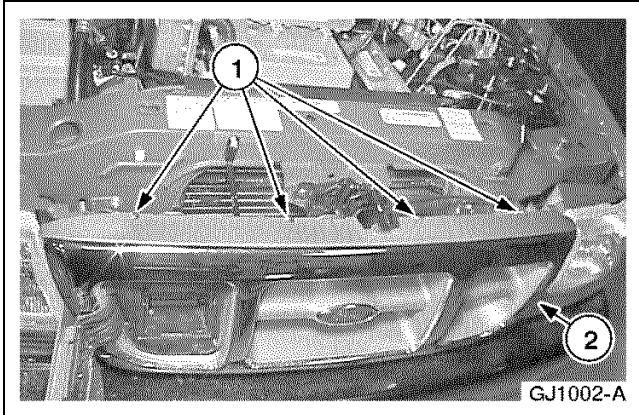
**REMOVAL AND INSTALLATION (Continued)**

2. Remove the grille.
  - 1 Remove the four screws.
  - 2 Remove the grille.

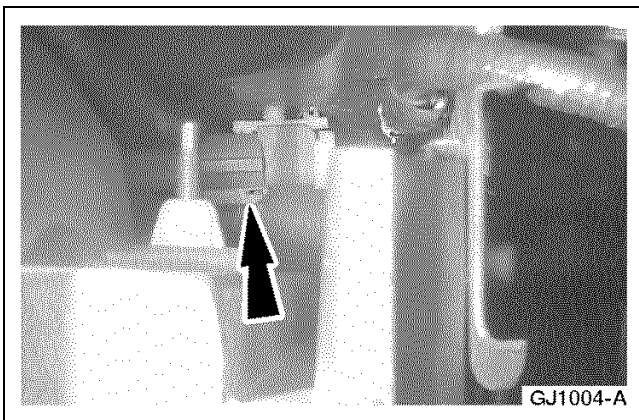

3. **NOTE:** The low-voltage connector is located at the rear of the charger inlet.  
Disconnect the low-voltage electrical connector.

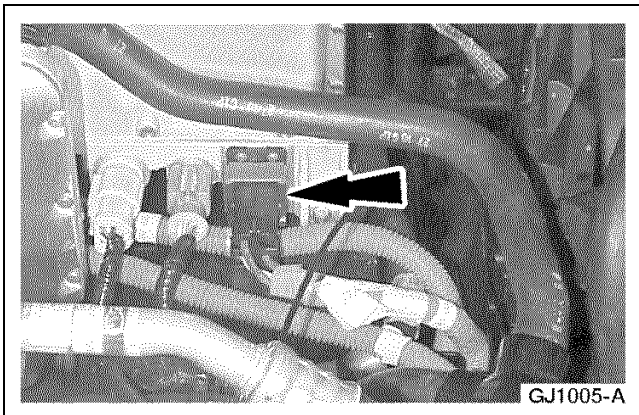

4. Disconnect the traction battery charger high-voltage electrical connector.
  - Unclip the four wiring harness clips.

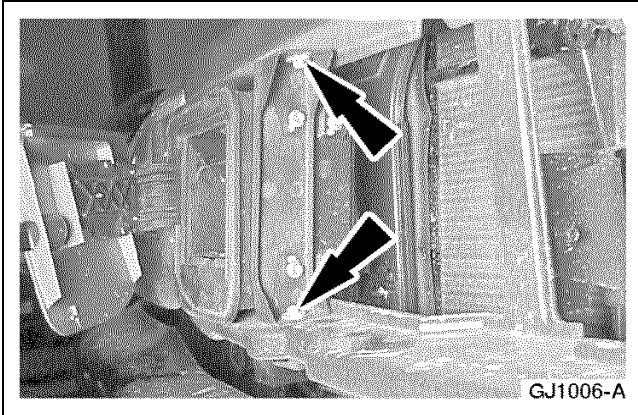
**REMOVAL AND INSTALLATION (Continued)**

5. Remove the two charge bracket bolts.

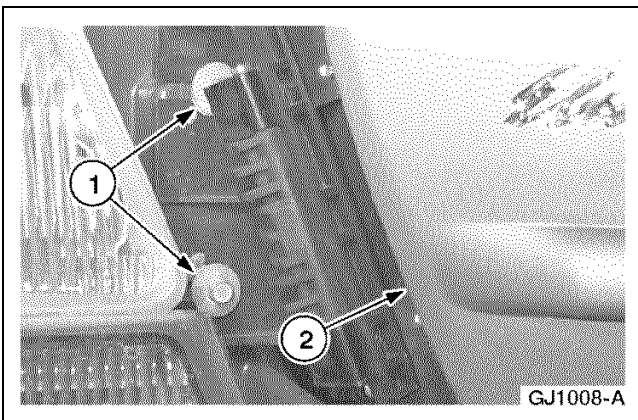

6. Remove the charge inlet.
  - 1 Loosen the two charge inlet bracket bolts.
  - 2 Slide the charge inlet from behind the bolts and remove.

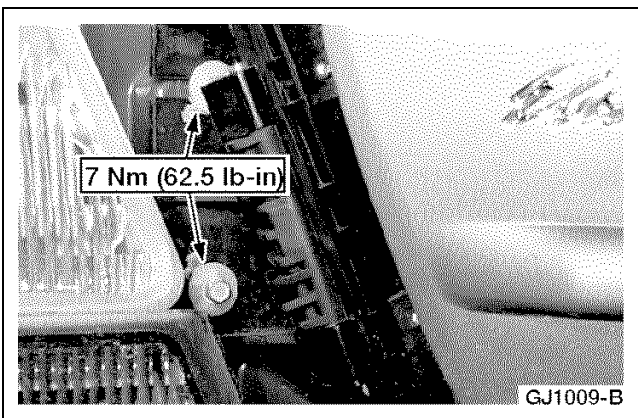
**Installation**

1. To install, reverse the removal procedure.

## REMOVAL AND INSTALLATION (Continued)

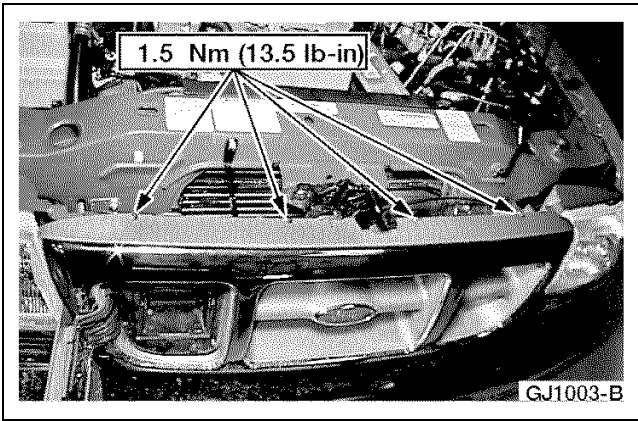
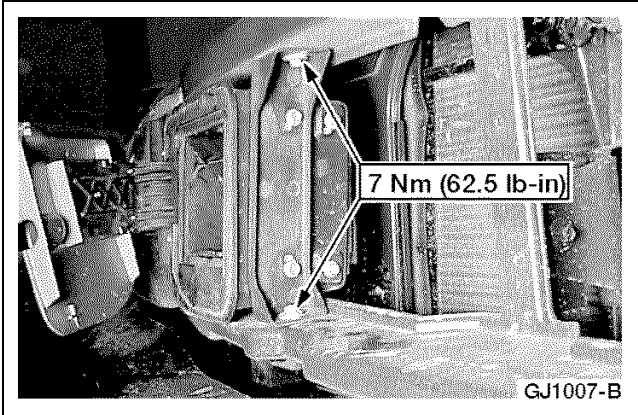

### Contactor Box

#### Special Tool(s)

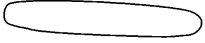
 <p data-bbox="259 1470 357 1491">ST2091-A</p>	<p data-bbox="397 1270 722 1333">Battery Terminal Cap Opener 418-F215</p>
---	---

### Removal

1. Remove the traction battery. Refer to [Traction Battery](#).

## REMOVAL AND INSTALLATION (Continued)

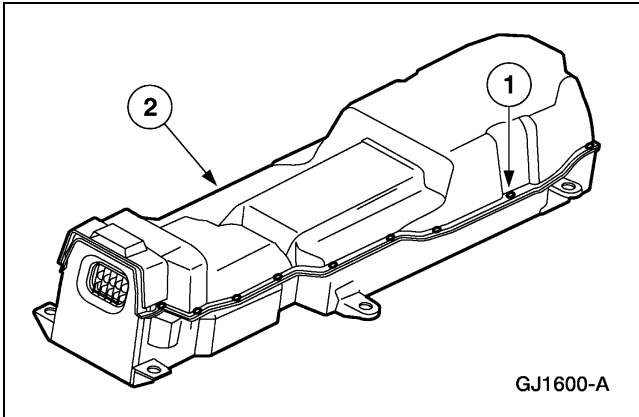

2. Remove the traction battery cover.
  - 1 Remove the 22 bolts.
  - 2 Remove the cover.

3. **⚠ WARNING: The nominal voltage of the traction battery is 300 volts. The buffer zone must be set up and insulated rubber gloves and a face shield must be worn. Failure to follow these precautions may result in severe personal injury or death.**

Observe the EV-specific precautions. Refer to [Section 100-00](#).

- 1 Set up the buffer zone.
- 2 Test and wear the insulated rubber gloves.
- 3 Wear the face shield.

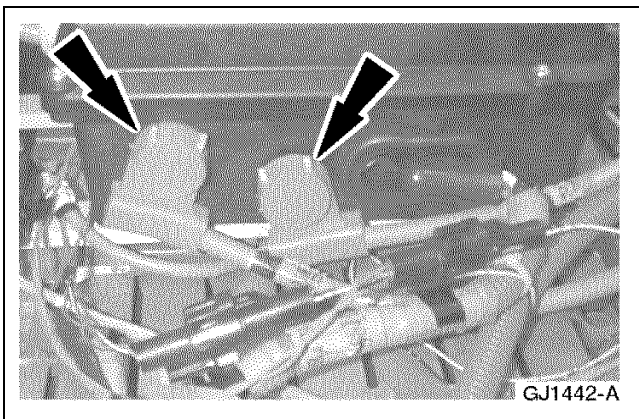

4. **⚠ CAUTION: Disconnect only one HVJ at a time.**

Disconnect the HVJs from the contactor box.

- Open the cap.
- Remove the bolt.

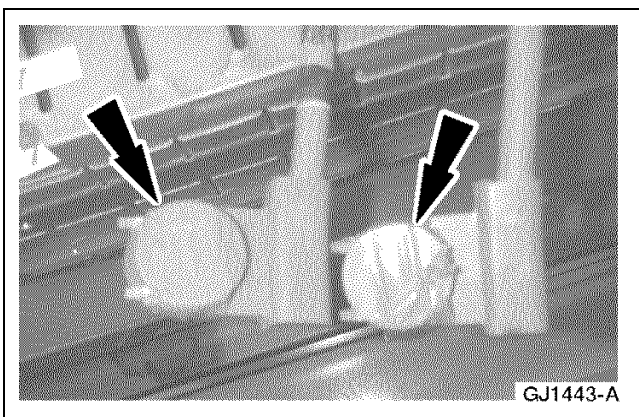

5. Wrap the HVJ ends with orange electrical tape.

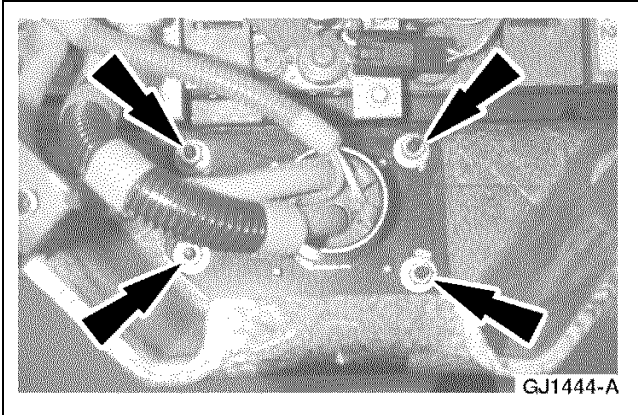
**REMOVAL AND INSTALLATION (Continued)**

6. Remove the two-pin high-voltage connector nuts.

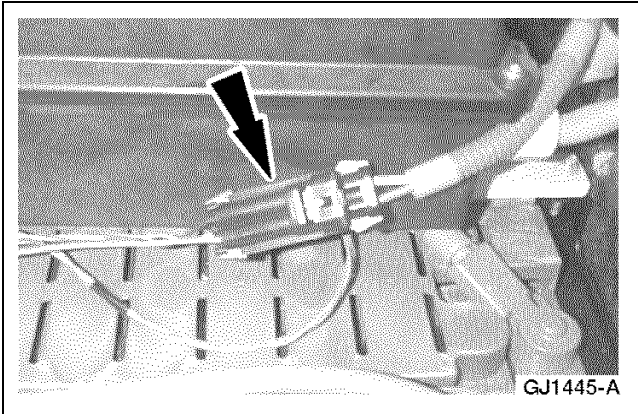

7. Disconnect the high-voltage interlock electrical connector.

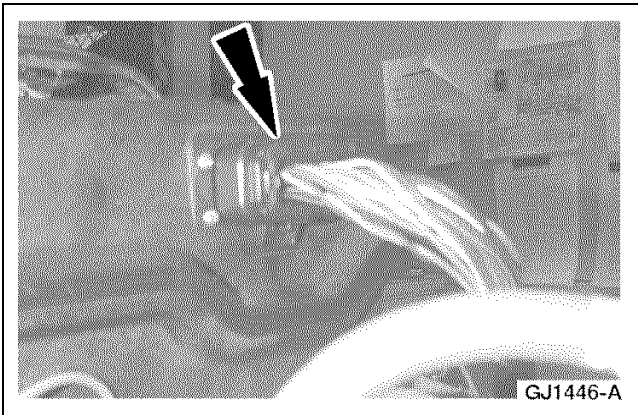

8. Disconnect the low-voltage electrical connector.

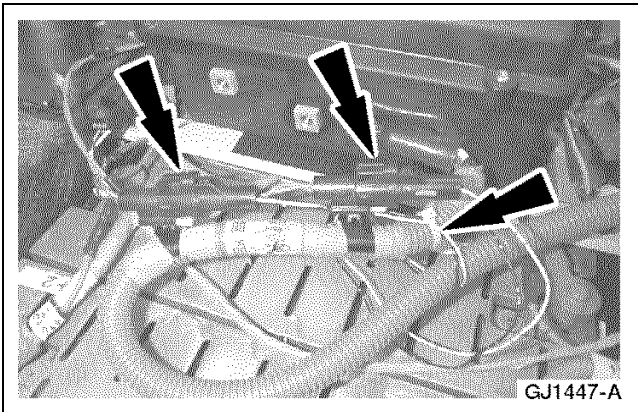

9. Unclip the thermistors from the high-voltage harness and cut the zip tie.

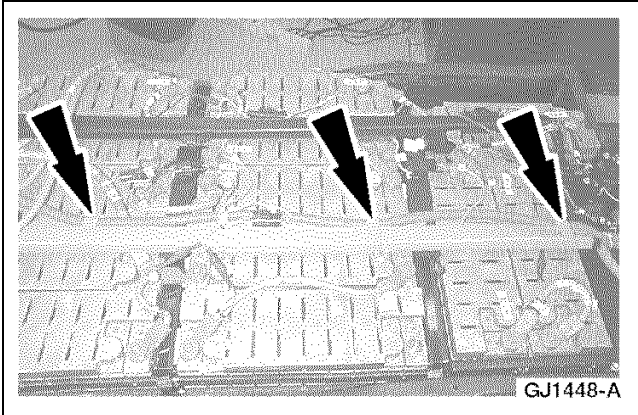

**REMOVAL AND INSTALLATION (Continued)**

10. Open the clips that secure the contactor box harness to the high-voltage harness.

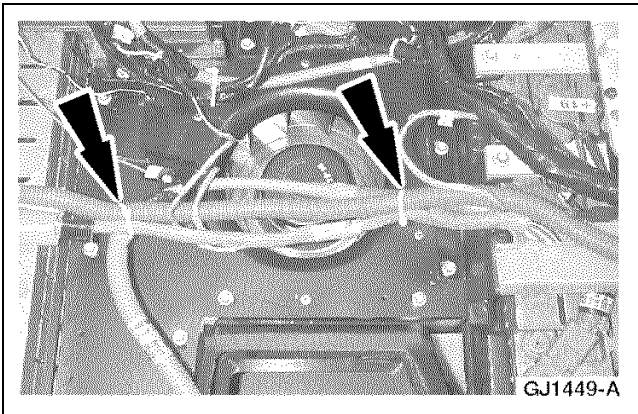

11. Cut the two zip ties securing the contactor box harness.

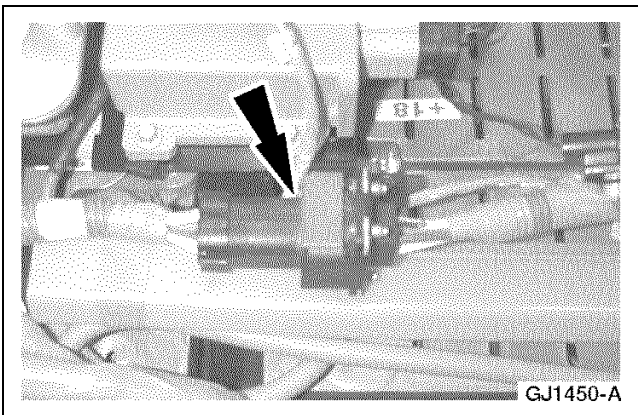

12. Disconnect the contactor box harness.

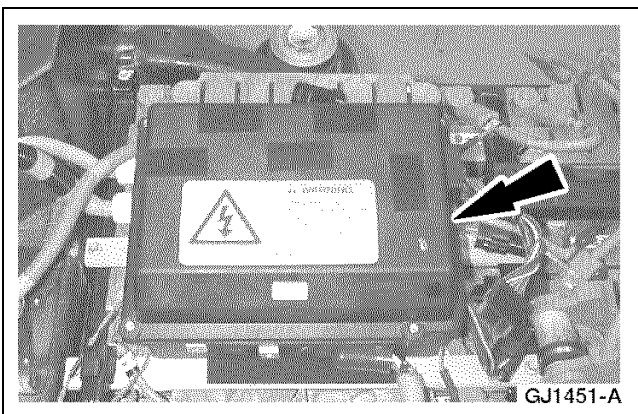

13. **NOTE:** The contactor box is held in place with strips of Velcro™. Remove the contactor box.

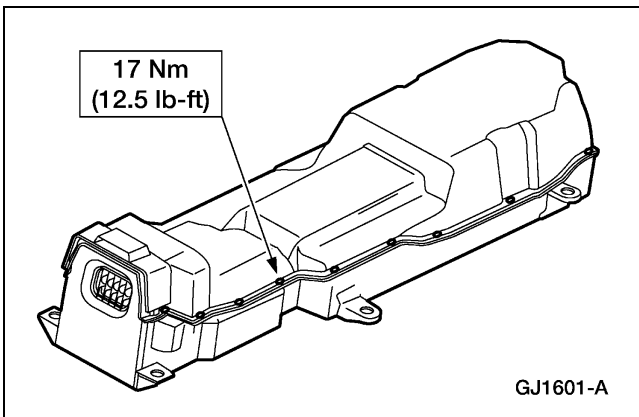
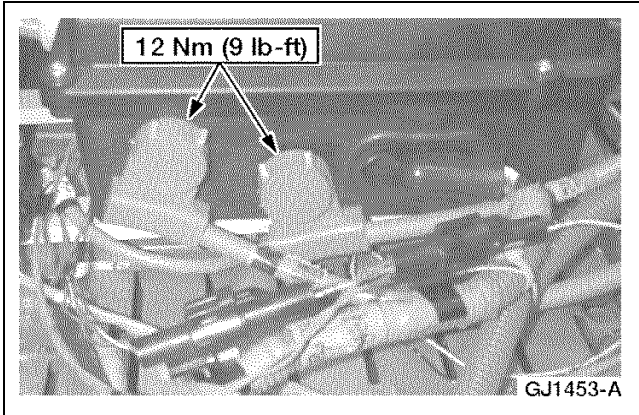
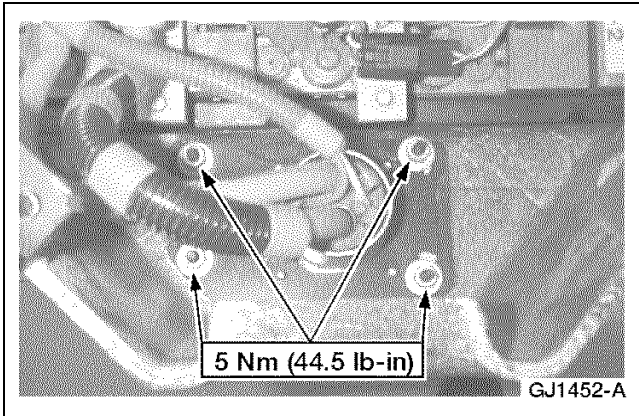
**REMOVAL AND INSTALLATION (Continued)****Installation**

1. To install, reverse the removal procedure.
  - Fill the high-voltage jumper connectors with Nyogel after final tightening of the nuts/bolts.
  - Apply Loctite 242 to the 22 traction battery cover bolts.

**Contactors Box Fuses****Removal**

1. Remove the traction battery. Refer to [Traction Battery](#).

## REMOVAL AND INSTALLATION (Continued)

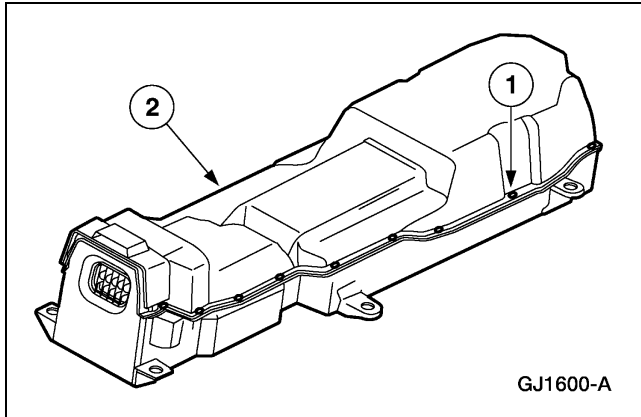

2. Remove the traction battery cover.
  - 1 Remove the 22 bolts.
  - 2 Remove the cover.

3. **⚠ WARNING: The nominal voltage of the traction battery is 300 volts. The buffer zone must be set up and insulated rubber gloves and a face shield must be worn. Failure to follow these precautions may result in severe personal injury or death.**

Observe the EV-specific precautions. Refer to [Section 100-00](#).

- 1 Set up the buffer zone.
- 2 Test and wear the insulated rubber gloves.
- 3 Wear the face shield.

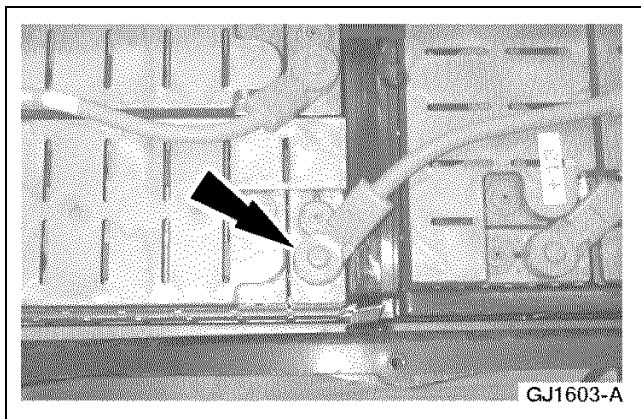

4. Disconnect the +23 module high voltage jumper.

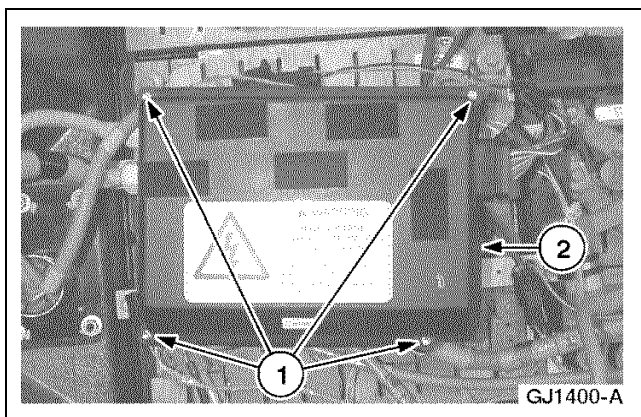

5. Open the contactor box.
  - 1 Remove the four screws.
  - 2 Open the contactor box.

## REMOVAL AND INSTALLATION (Continued)

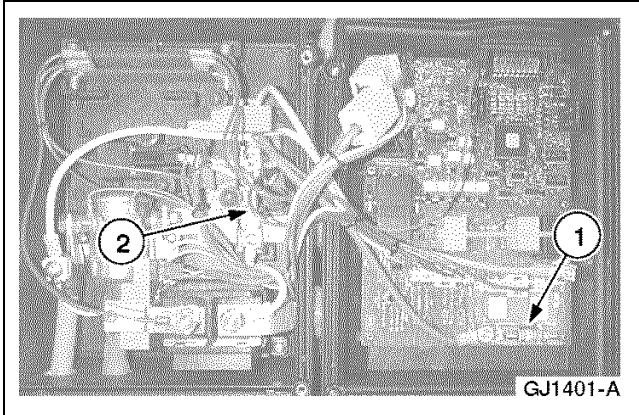

6. Use a fuse puller to remove the necessary fuse.
  - 1 25A Charger Fuse
  - 2 40A Auxiliary Fuse

### Installation

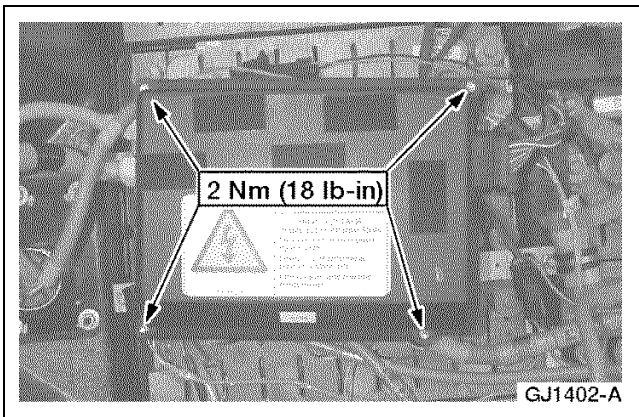

1. To install, reverse the removal procedure.
  - Apply Loctite 242 to the 22 traction battery cover bolts.

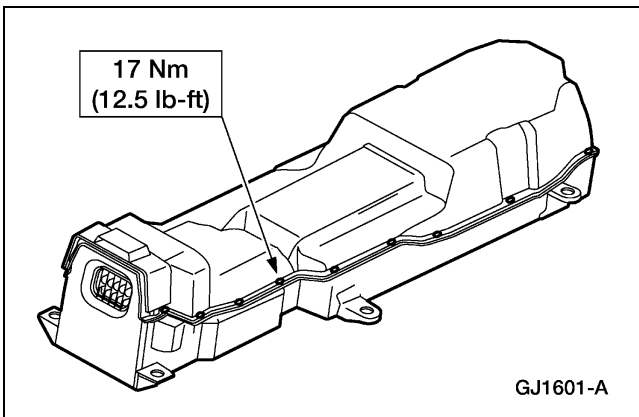

## HVPDB Fuses

### Removal

1. Disconnect the traction battery auxiliary load high-voltage connector. Refer to [Section 100-05](#).

## REMOVAL AND INSTALLATION (Continued)

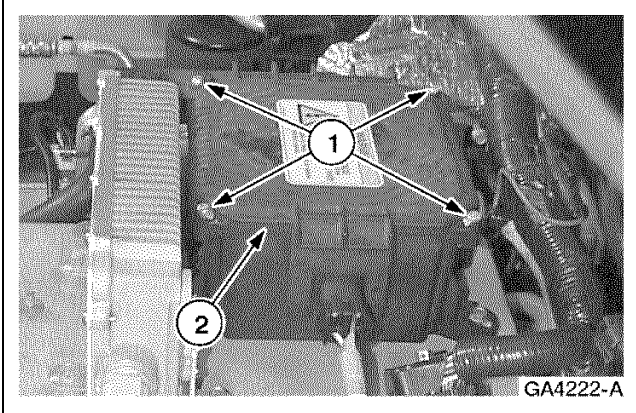

2. Remove the high-voltage power distribution box (HVPDB) cover.
  - 1 Remove the four screws.
  - 2 Remove the cover.

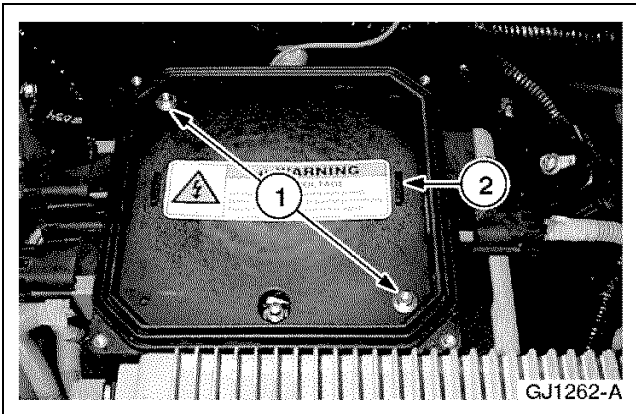

3. Remove the HVPDB fuse safety cover.
  - 1 Remove the two screws.
  - 2 Remove the cover.

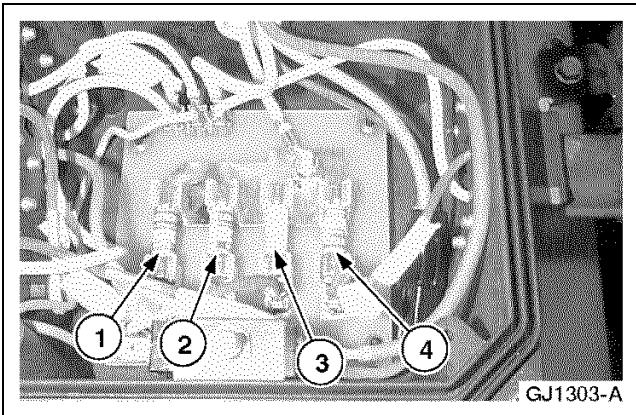

4. Use a fuse puller to remove the necessary fuse.
  - 1 10A Power Steering Fuse
  - 2 25A Positive Temperature Coefficient (PTC) Heater Fuse
  - 3 25A A/C Fuse
  - 4 10A DC/DC Fuse

### Installation

1. To install, reverse the removal procedure.

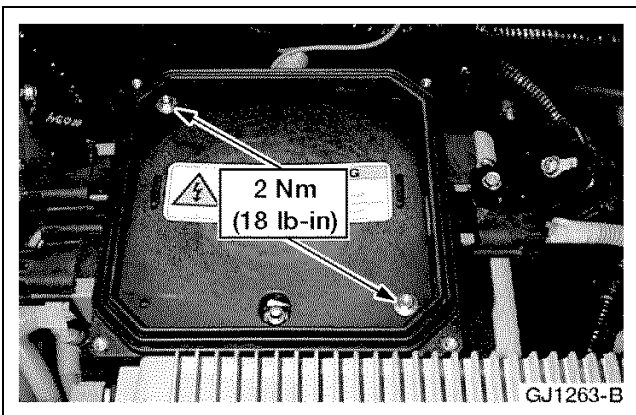

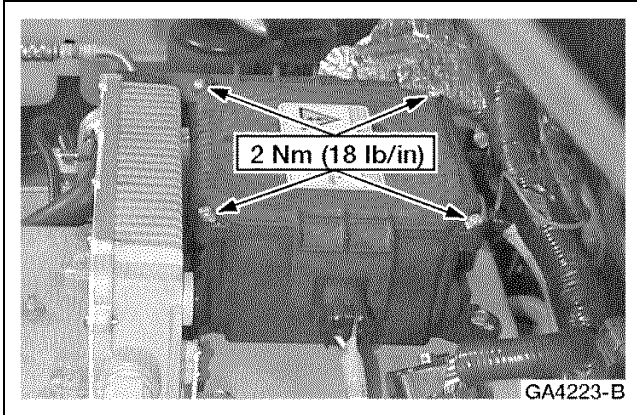
**REMOVAL AND INSTALLATION (Continued)****High Voltage Power Distribution Box (HVPDB)****Removal**

1. Remove the positive temperature coefficient (PTC) module. Refer to [Section 412-04](#).
2. Disconnect the power steering pump electrical connector.
3. Disconnect the electrical connectors.

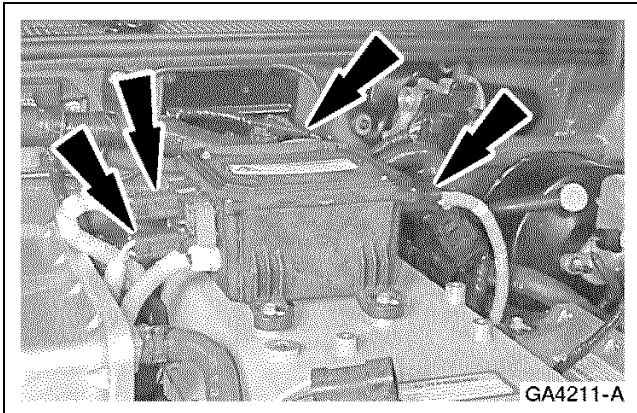
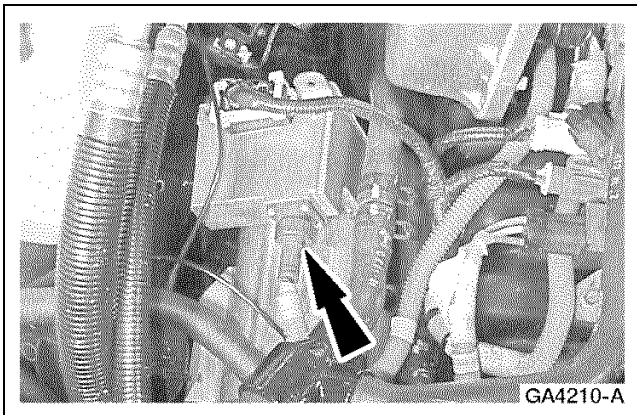

## REMOVAL AND INSTALLATION (Continued)

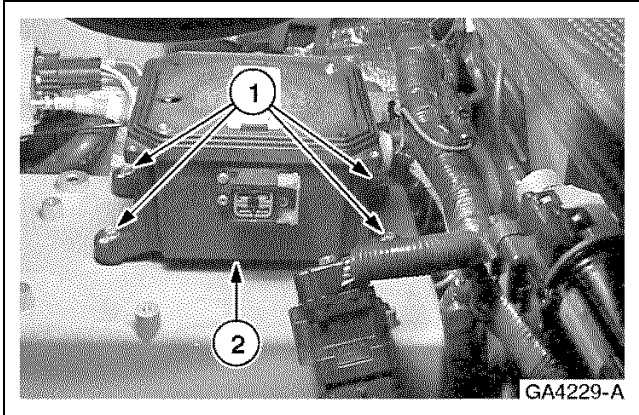

4. **NOTE:** The HVPDB power supply cable is held in position with three clips.

Remove the HVPDB.

- 1 Remove the bolts.
- 2 Remove the HVPDB.

### Installation

1. To install, reverse the removal procedure.

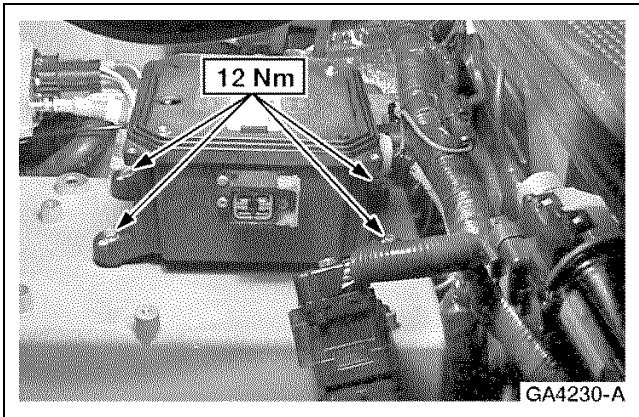

## High Voltage Wiring —Sensor Lead Harness (10B694)

### Removal

1. Remove the traction battery. Refer to [Traction Battery](#).
2. Remove the traction battery cover.
  - 1 Remove the 22 bolts.
  - 2 Remove the cover.

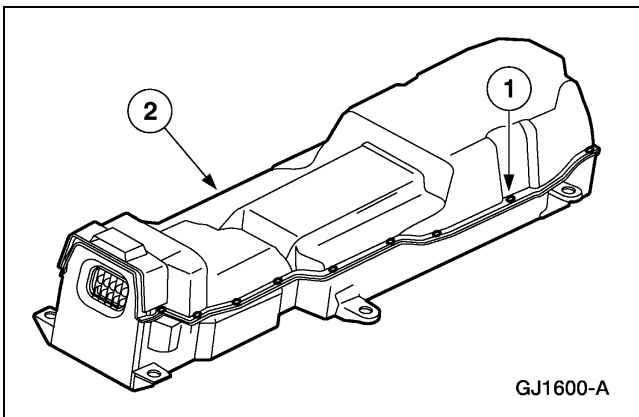

## REMOVAL AND INSTALLATION (Continued)

3.  **WARNING:** The nominal voltage of the traction battery is 300 volts. The buffer zone must be set up and insulated rubber gloves and a face shield must be worn. Failure to follow these precautions may result in severe personal injury or death.

Observe the EV specific precautions. Refer to [Section 100-00](#).

- 1 Set up the buffer zone.
- 2 Test and wear the insulated rubber gloves.
- 3 Wear the face shield.



4. Open the clips that secure the contactor box harness to the high-voltage harness.

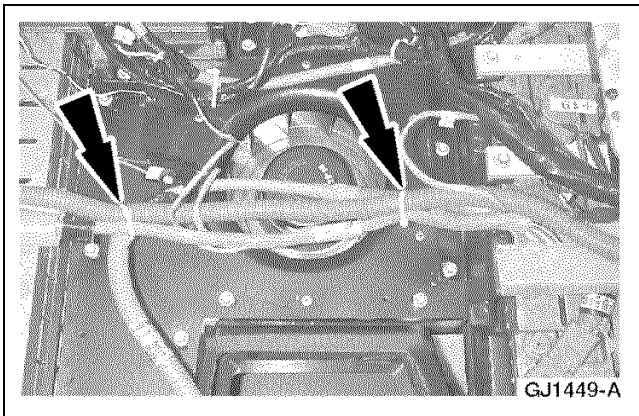

5. Cut the two zip ties securing the contactor box harness.

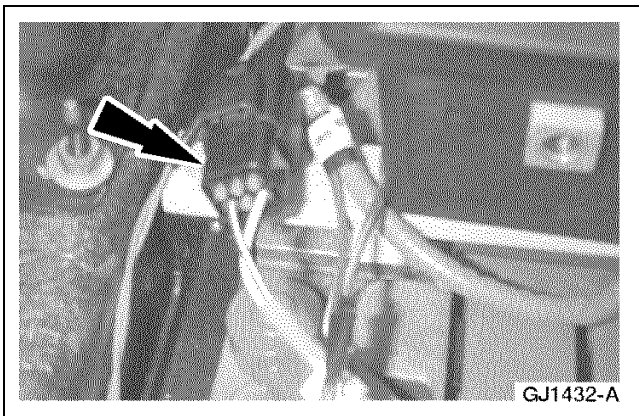

6. Unclip and disconnect the sense lead located behind the contactor box.

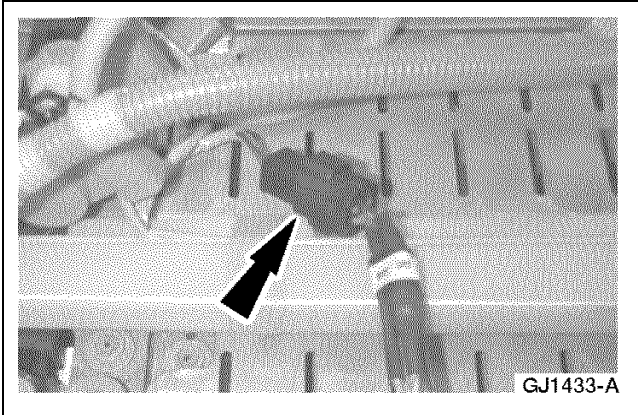

**REMOVAL AND INSTALLATION (Continued)**

7. Unclip and disconnect the sense lead located above battery module 1.

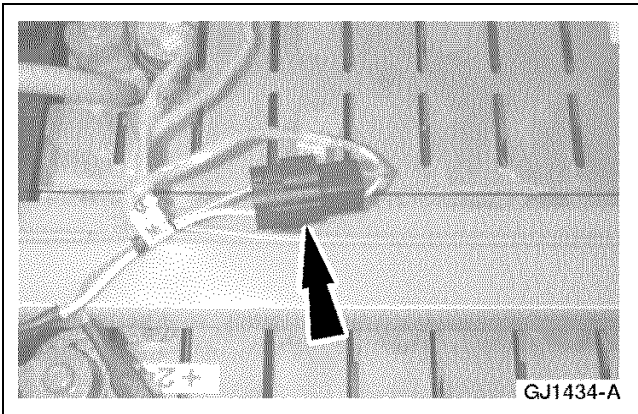

8. Unclip and disconnect the sense lead located above battery module 24.

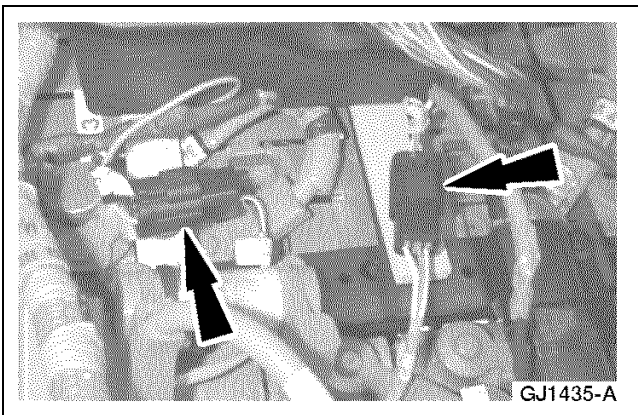

9. Unclip and disconnect the sense leads located in front of the contactor box.

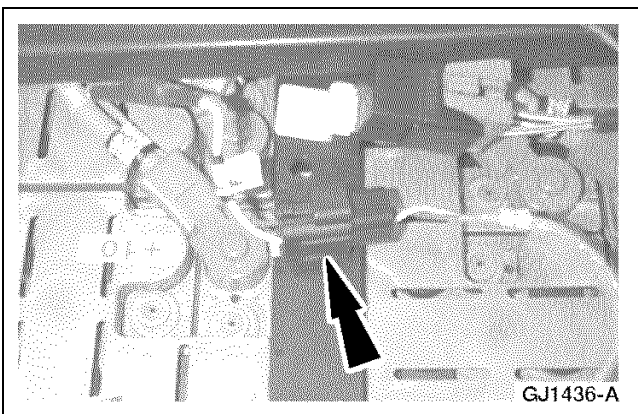

10. Unclip and disconnect the sense lead located above battery module 10.

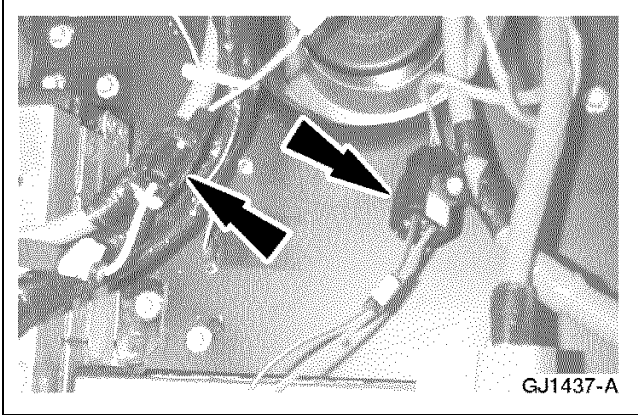
**REMOVAL AND INSTALLATION (Continued)**

11. Unclip and disconnect the sense leads located above the recirculating blower cover.

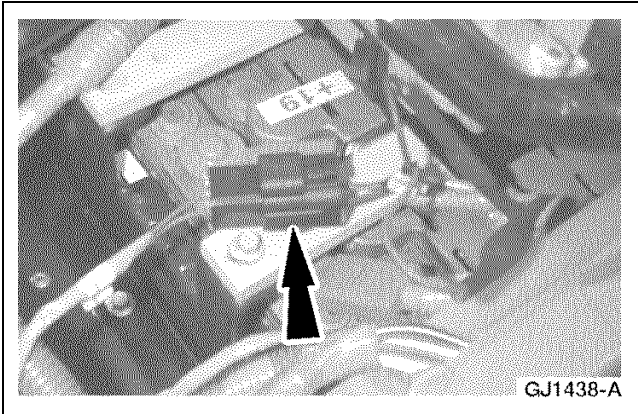

12. Unclip and disconnect the sense lead located above battery module 19.

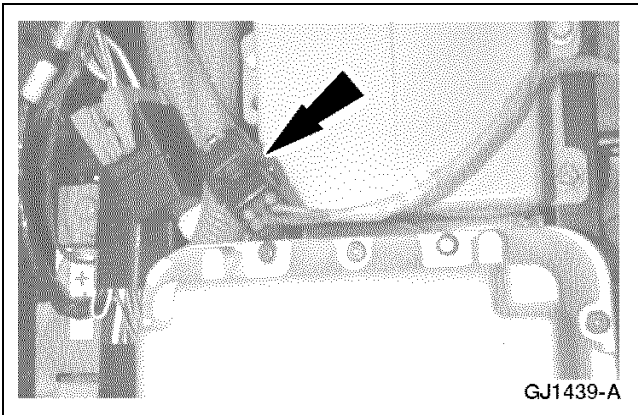

13. Unclip and disconnect the sense lead located between the battery control module and independent observer module.

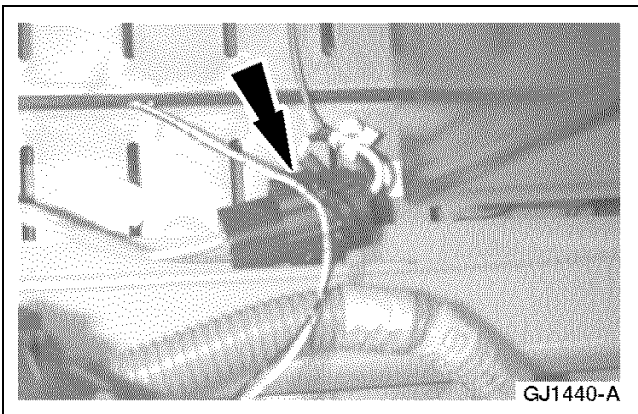

14. Unclip and disconnect the sense lead located above battery module 21.

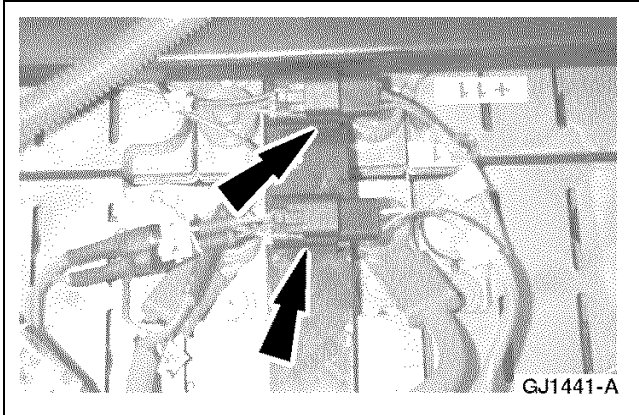
**REMOVAL AND INSTALLATION (Continued)**

15. Unclip and disconnect the sense leads located above battery modules 11 and 10.

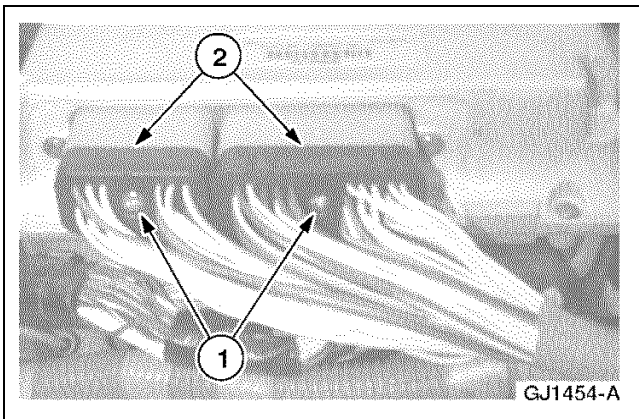

16. Remove the six high voltage harness pushpins and remove the harness.
17. Disconnect the high-voltage sense lead harness from the battery control module (BCM).
  - 1 Loosen the bolt.
  - 2 Disconnect the connector.

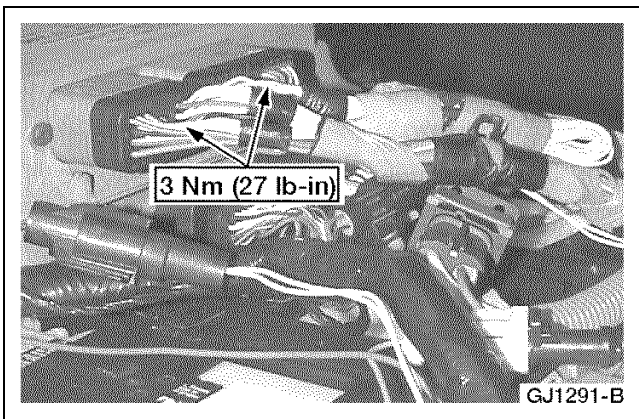
**Installation**

1. To install, reverse the removal procedure.
  - Apply Loctite 242 to the 22 traction battery cover bolts.

---

**REMOVAL AND INSTALLATION (Continued)****High Voltage Wiring****Special Tool(s)**

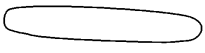
 ST2091-A	Battery Terminal Cap Opener 418-F215
---	---

### REMOVAL AND INSTALLATION (Continued)

#### High-Voltage Jumper Routing

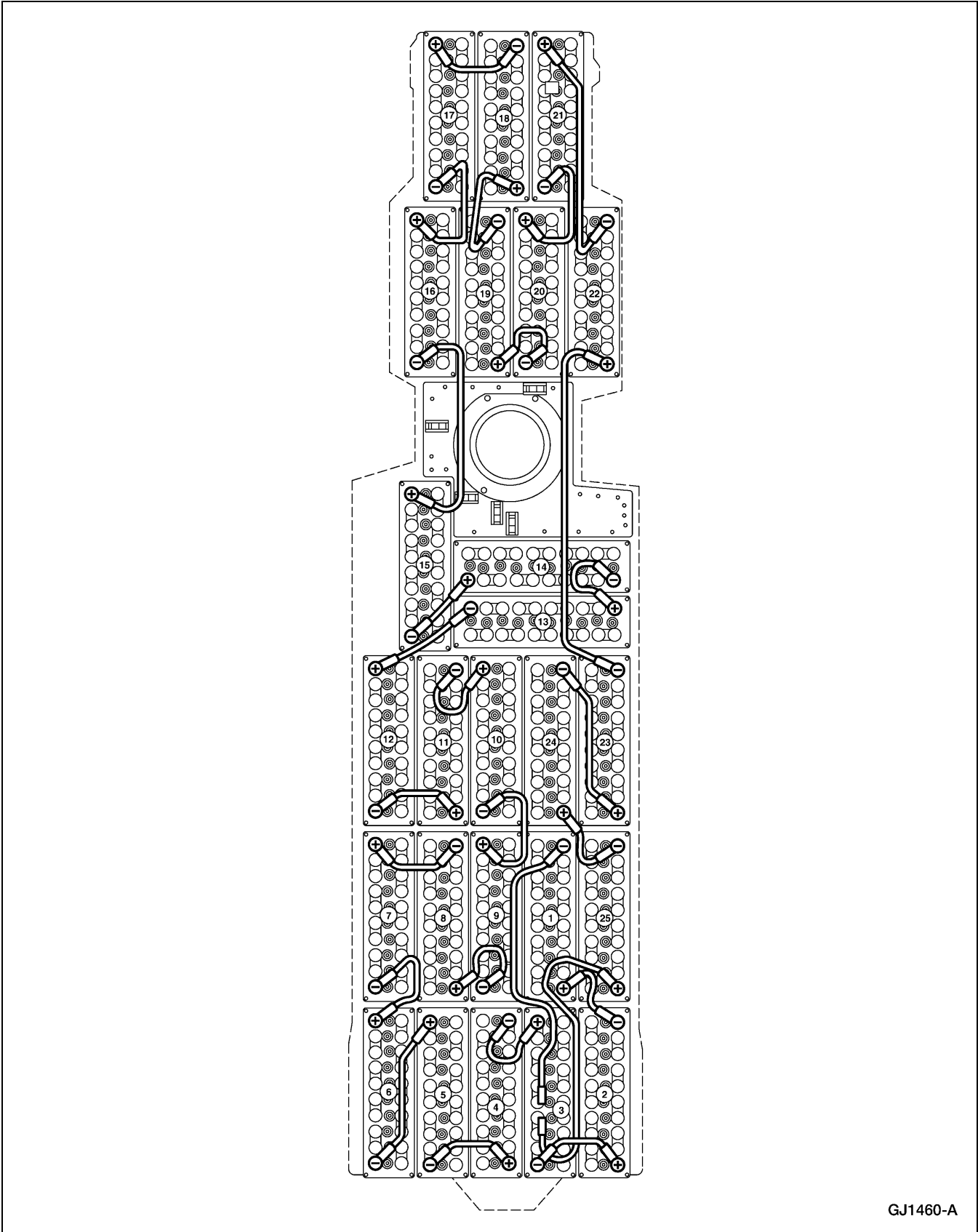

## REMOVAL AND INSTALLATION (Continued)

### Removal

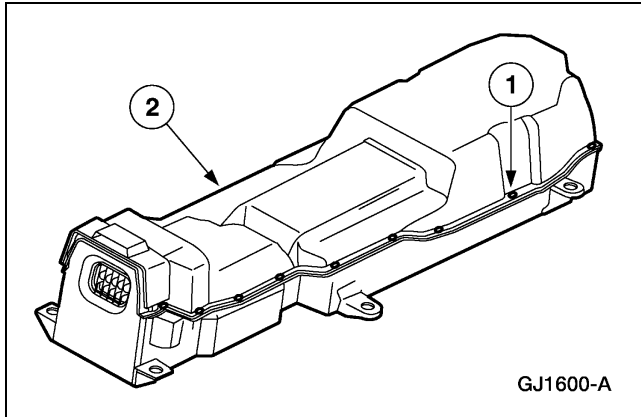

1. Remove the traction battery. Refer to [Traction Battery](#).
2. Remove the traction battery cover.
  - 1 Remove the 22 bolts.
  - 2 Remove the cover.
3. **⚠ WARNING:** The nominal voltage of the traction battery is 300 volts. The buffer zone must be set up and insulated rubber gloves and a face shield must be worn. Failure to follow these precautions may result in severe personal injury or death.
 

Observe the EV-specific precautions. Refer to [Section 100-00](#).

  - 1 Set up the buffer zone.
  - 2 Test and wear the insulated rubber gloves.
  - 3 Wear the face shield.
4. Refer to the High-Voltage Jumper (HVJ) wiring diagram to determine the location of the HVJ to be replaced.
5. Remove the components necessary to gain access to the HVJ. Refer to the procedures in this section.
6. **NOTE:** The sense lead is a thin orange wire that is part of the HVJ.
 

Disconnect the sense lead connector for the HVJ being removed.

## REMOVAL AND INSTALLATION (Continued)

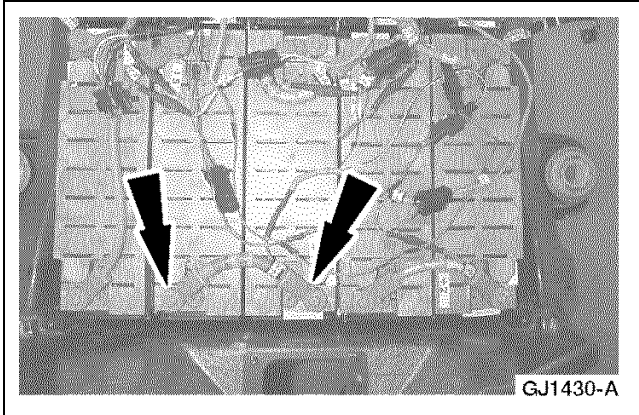

7. Remove the HVJ.
  - Use the Battery Terminal Cap Opener to open the battery module caps.
  - Remove and discard the two nuts.

### Installation

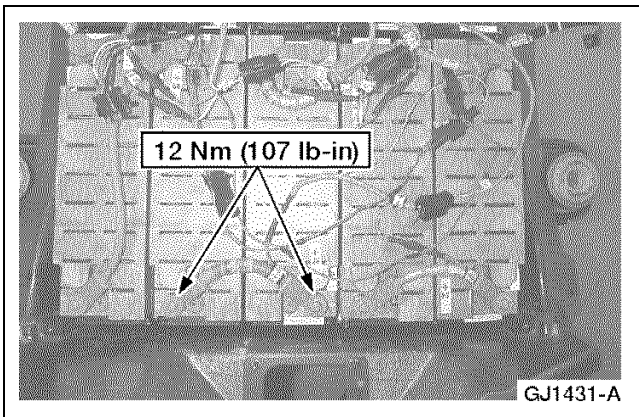

1. To install, reverse the removal procedure.
  - Refill the HVJ caps with Nyogel after tightening the nuts.
  - Apply Loctite 242 to the 22 traction battery cover bolts.

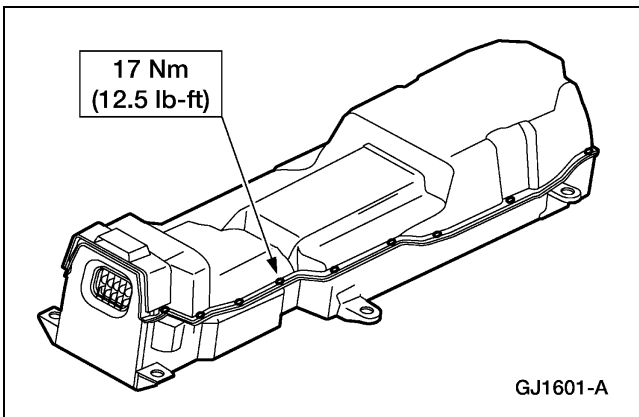

## Traction Battery

### Removal

1. Disconnect the traction battery auxiliary load high-voltage connector. Refer to [Section 100-05](#).

**REMOVAL AND INSTALLATION (Continued)**

2. Disconnect the traction battery high-voltage two-pin connector. Refer to [Section 100-05](#).
3.  **WARNING: The nominal voltage of the traction battery is 300 volts. The buffer zone must be set up and insulated rubber gloves and a face shield must be worn. Failure to follow these precautions may result in severe personal injury or death.**  
Observe the EV-specific precautions. Refer to [Section 100-00](#).
  - 1 Set up the buffer zone.
  - 2 Test and wear the insulated rubber gloves.
  - 3 Wear the face shield.
4. Secure the two-pin high-voltage cable to the rear axle to hold it out of the way.

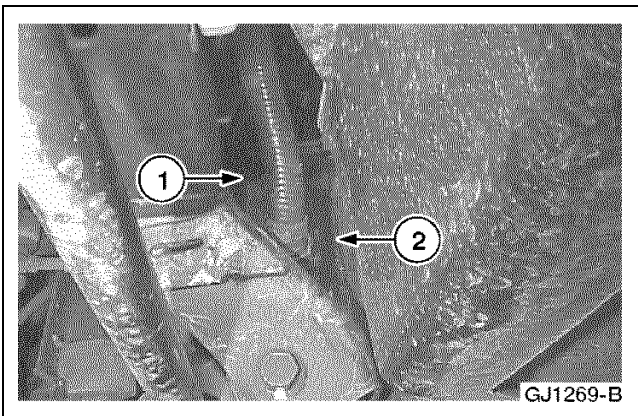
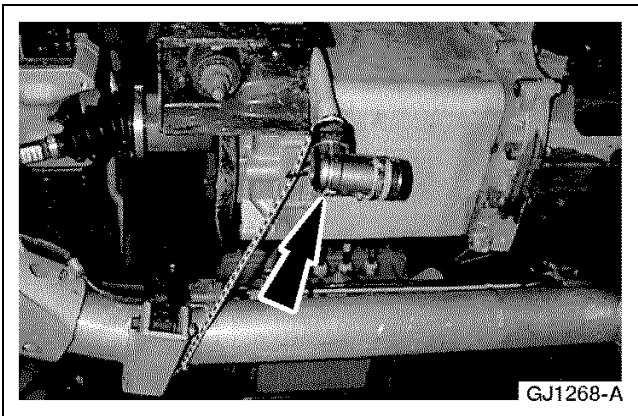

5. Disconnect the 76-pin electrical connector.
  - 1 Loosen the bolt.
  - 2 Disconnect the electrical connector.



## REMOVAL AND INSTALLATION (Continued)

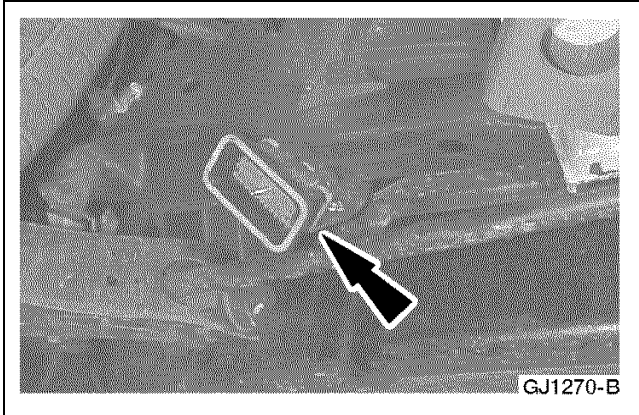

6. Position the 76-pin electrical connector over the control arm.

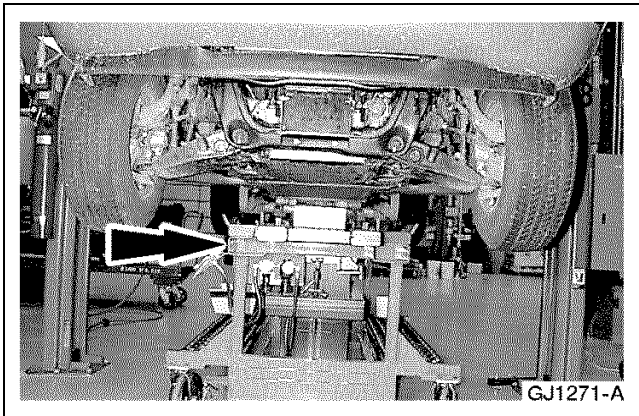

7. Position the lift table under the battery pack assembly.
  - The narrow end of the pallet faces the front of the vehicle.

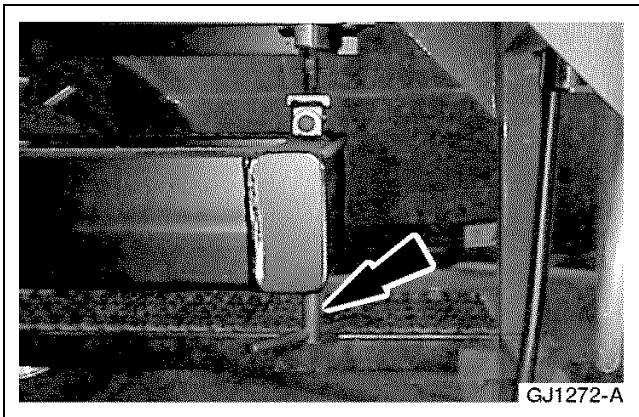

8. Completely lower the lift table and then lower the vehicle until the battery pack is within 25.5 cm (10 in) of the lift table. Verify that the safety locks on the lift are engaged.
9. Adjust the lift table so it is parallel with the battery pack.
  - Turn the adjustment screw at the front of the lift table to vary the angle of the lift table.

10. **NOTE:** A second person is necessary to position and guide the lift table.

Align the lift table with the battery pack.

## REMOVAL AND INSTALLATION (Continued)

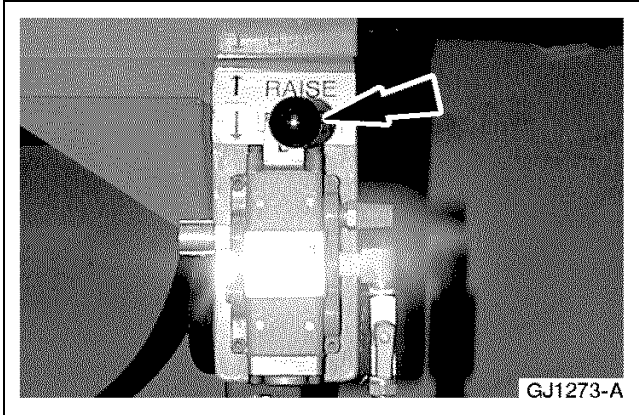

11. **NOTE:** The lift table operates using a minimum of 80 psi and a maximum of 120 psi of compressed air.

Slowly raise the lift table until it contacts the bottom of the battery pack.

- Push the lever up.

12.  **CAUTION: Do not adjust either regulator for more than 60 psi.**

**NOTE:** The lift table is designed to only lift the battery pack assembly. It will not lift the entire vehicle.

Continue to lift the battery pack until the lift table system pressure equalizes and both gauges reach 60 psi.

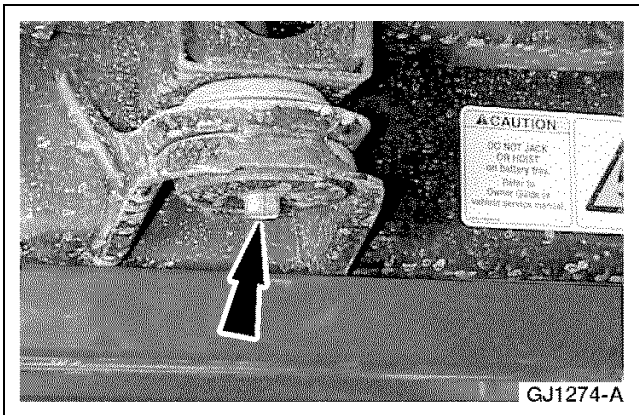

13. **NOTE:** There are three mounting bolts on both the left and right sides of the traction battery. Remove the six mounting bolts from the battery pack.

14. Lower the lift table slowly until it rests on the pallet stops and system pressure is completely released (0 psi).

15. Raise the vehicle.

## REMOVAL AND INSTALLATION (Continued)

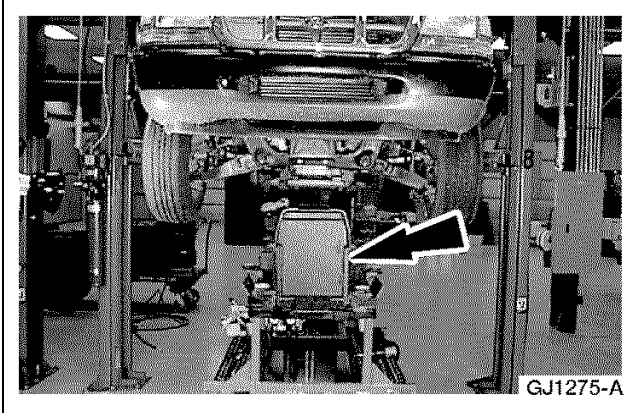

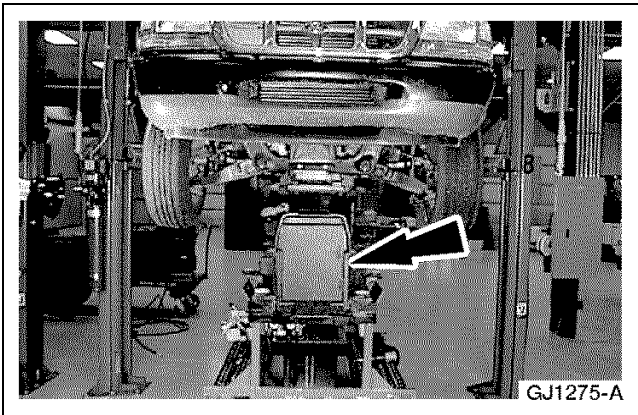

16. Release the lift table brake, disconnect the air hose, and roll the lift table from under the vehicle.

### Installation

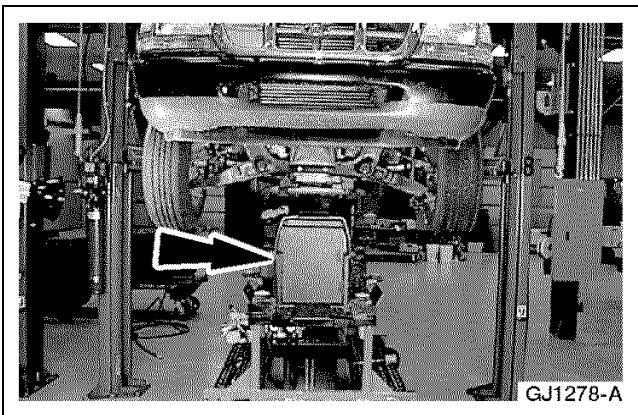

1. Raise and support the vehicle. Refer to [Section 100-02](#).
2. Position the lift table and battery pack under the vehicle.
  - Connect the lift table to the shop air supply.



3. With the assistance of a second person, carefully lower the vehicle down to within ten inches (25.4 cm) of the battery pack.
4.  **CAUTION: Make sure the vehicle and battery pack are aligned during battery pack installation.**  
Lift the battery pack up into the mounting position.

## REMOVAL AND INSTALLATION (Continued)

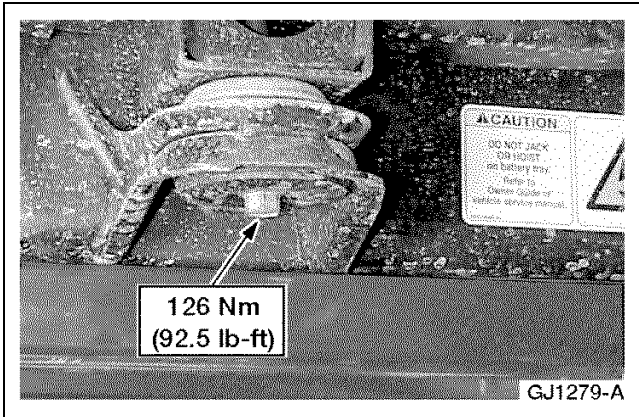

5. **NOTE:** The RH front bolt must be installed first in order to correctly align the battery pack. Install the battery pack mounting bolts.

- Apply Loctite 242 to the bolts prior to installation.
- Install the LH front bolt first in order to properly locate the battery pack.

6. Lower the lift table and disconnect the shop air source.

7. Raise the vehicle and roll the lift table from under the vehicle.

8. **NOTE:** The bolt will break if the specified torque is exceeded. If this happens, pull the connector off the bolt stem and remove the broken bolt.

Connect the 76-pin connector and tighten the bolt.

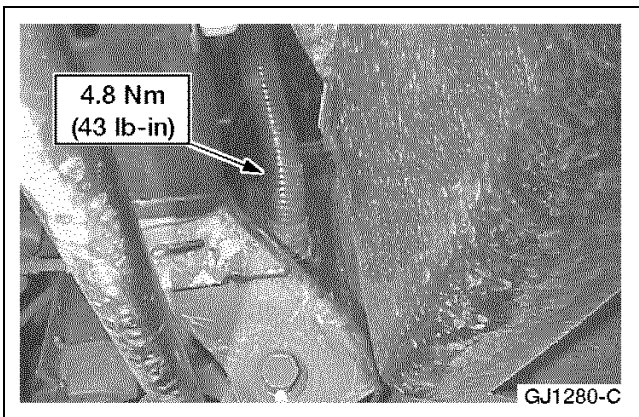

9. Connect the traction battery auxiliary load high-voltage connector. Refer to [Section 100-05](#).

10. Connect the traction battery two-pin high-voltage connector. Refer to [Section 100-05](#).

## Traction Battery Charger

### Removal

1. Remove the high-voltage power distribution box (HVPDB). Refer to [High Voltage Power Distribution Box \(HVPDB\)](#).

## REMOVAL AND INSTALLATION (Continued)

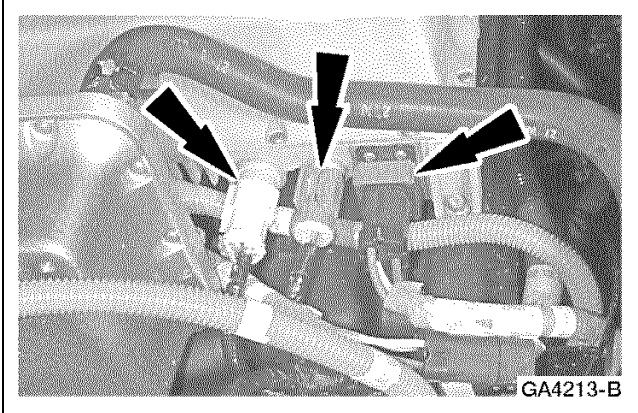

2. Disconnect the traction battery charger electrical connectors.

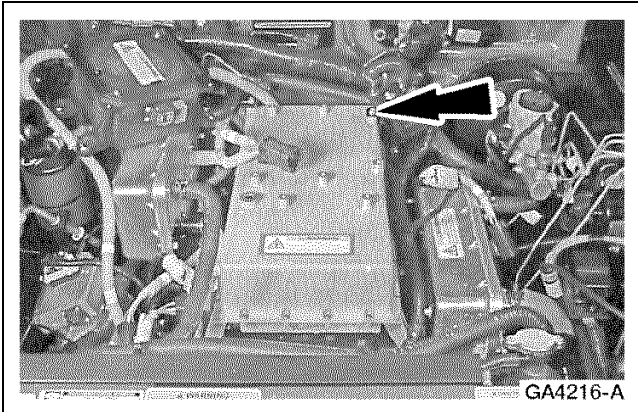

3. Remove the harness bracket.
  - Remove the bolt.

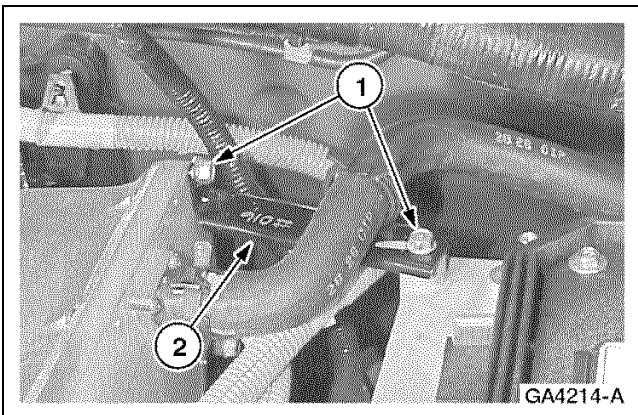

4. Remove the A/C inverter motor controller (IMC) bracket.
  - 1 Remove the bolts.
  - 2 Remove the bracket.

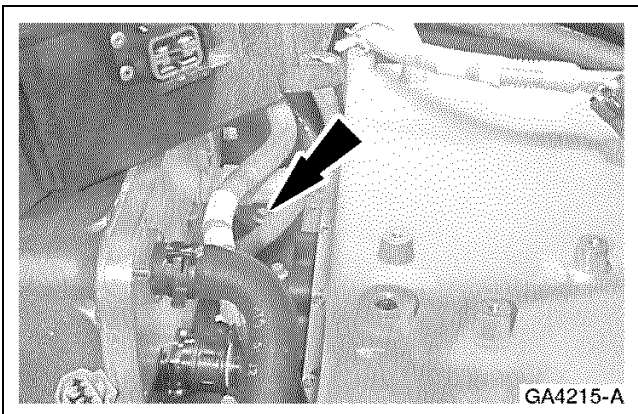

5. Remove the ground strap bolt.

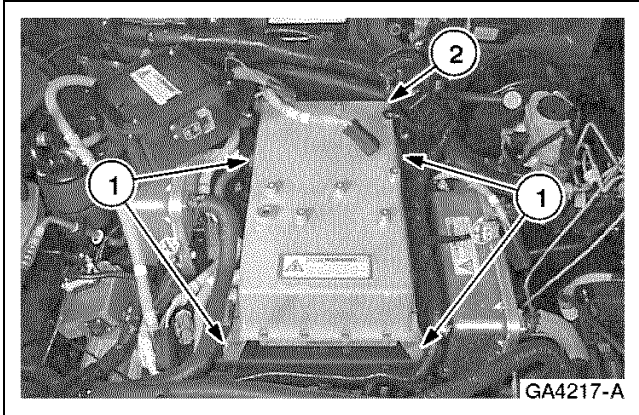
**REMOVAL AND INSTALLATION (Continued)**

6. Remove the traction battery charger.
  - 1 Remove the four bolts.
  - 2 Remove the charger.

**Installation**

1. To install, reverse removal procedure.

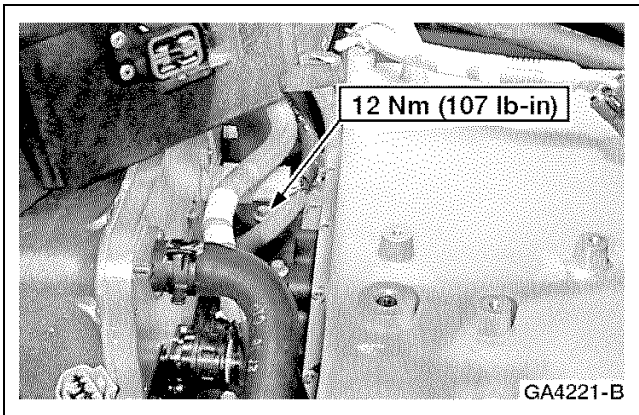
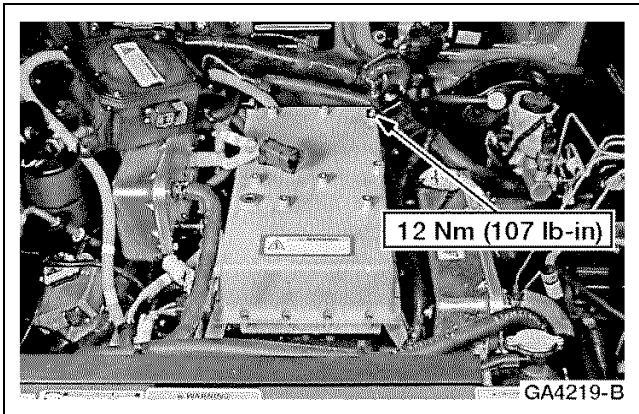
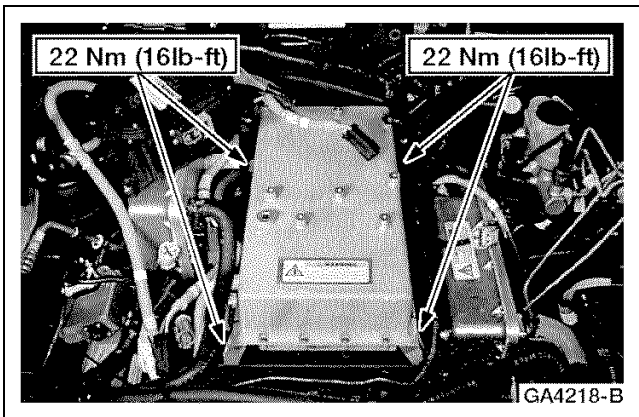

## REMOVAL AND INSTALLATION (Continued)

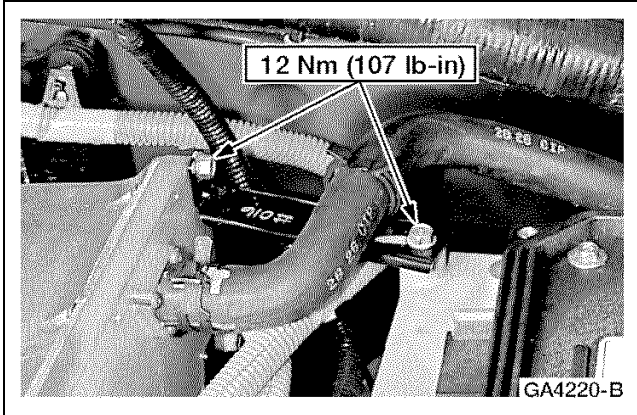

## Flow Through Blower

### Removal

1. Remove the traction battery. Refer to [Traction Battery](#).
2. Remove the traction battery cover.
  - 1 Remove the 22 bolts.
  - 2 Remove the cover.
3. Remove the blower cover.
  - 1 Remove the four bolts (two each side).
  - 2 Remove the blower cover.

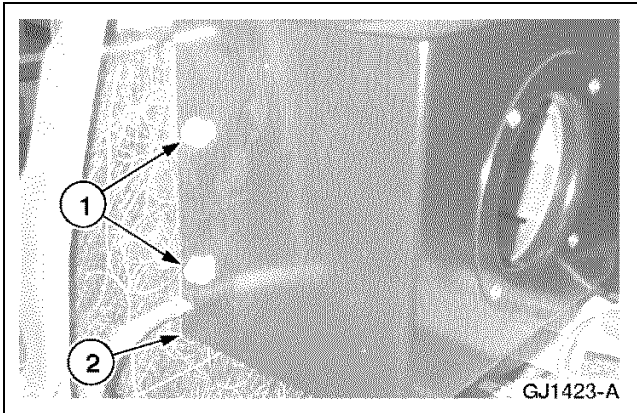
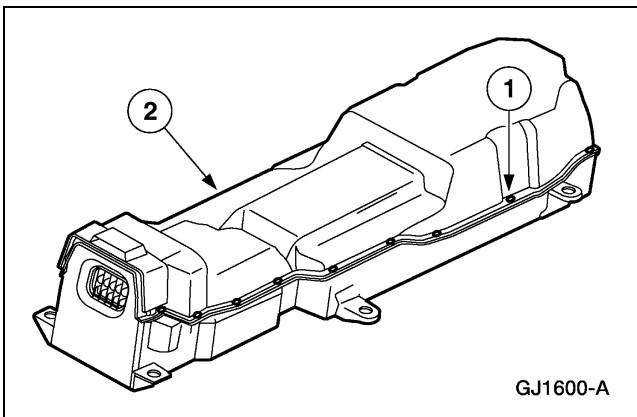

## REMOVAL AND INSTALLATION (Continued)

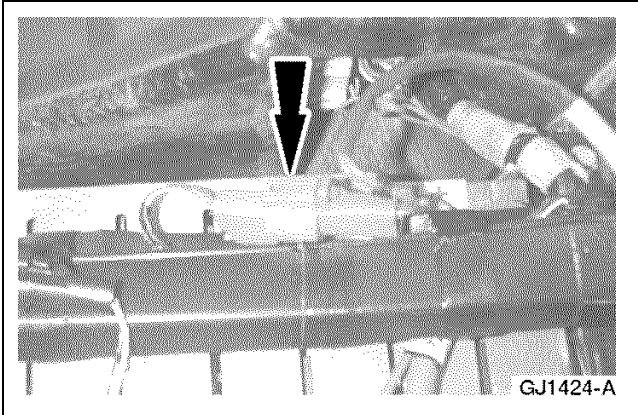

4. Disconnect the blower electrical connector.

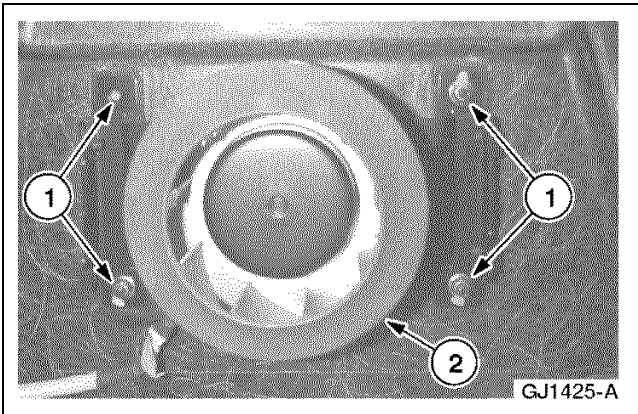

5. **⚠ CAUTION: The flow through blower is very fragile and can easily be damaged if mishandled.**

Remove the flow through blower.

- 1 Remove the nuts.
- 2 Remove the blower.

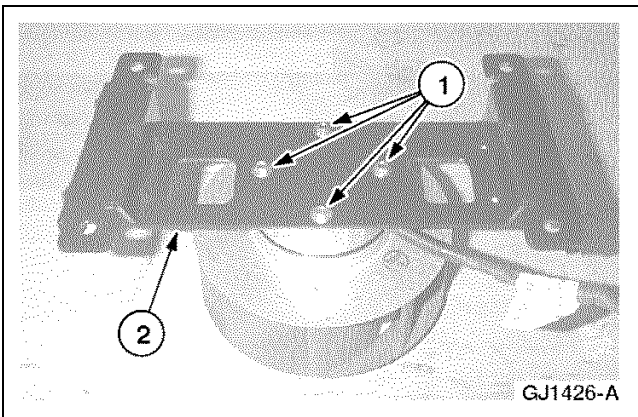

6. Remove the flow through blower bracket.

- 1 Remove the bolts.
- 2 Remove the bracket.

### Installation

1. To install, reverse the removal procedure.

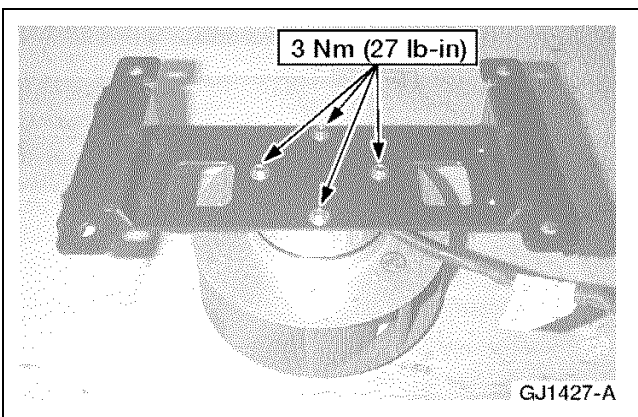

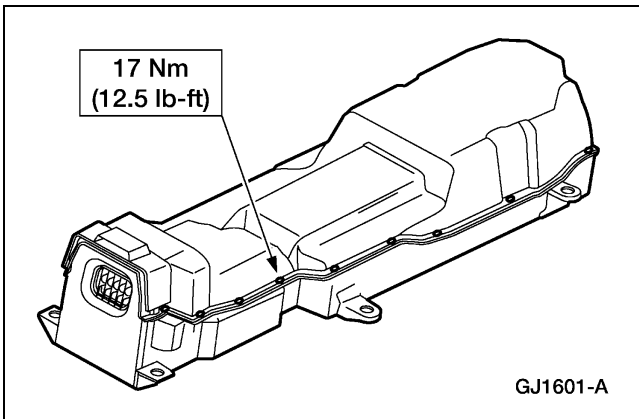
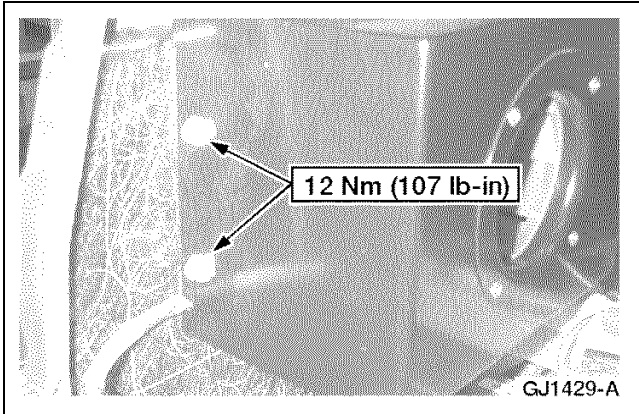
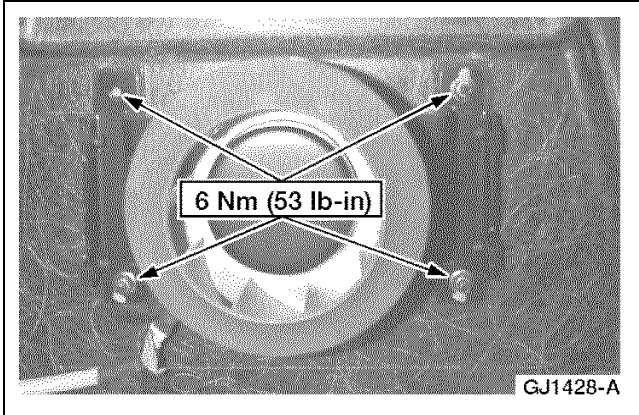

**REMOVAL AND INSTALLATION (Continued)****Recirculating Blower****Removal**

1. Remove the traction battery. Refer to [Traction Battery](#).

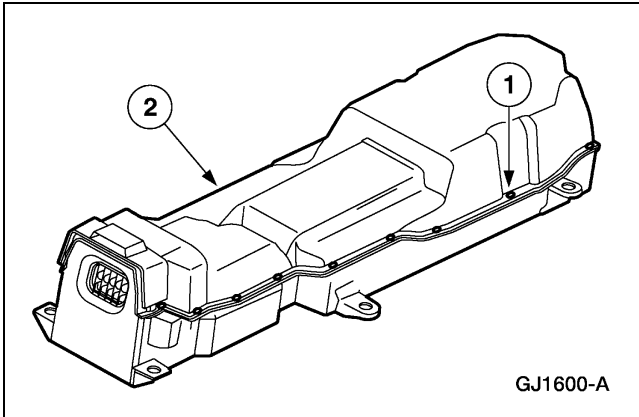
**REMOVAL AND INSTALLATION (Continued)**

2. Remove the traction battery cover.

- 1 Remove the 22 bolts.

- 2 Remove the cover.

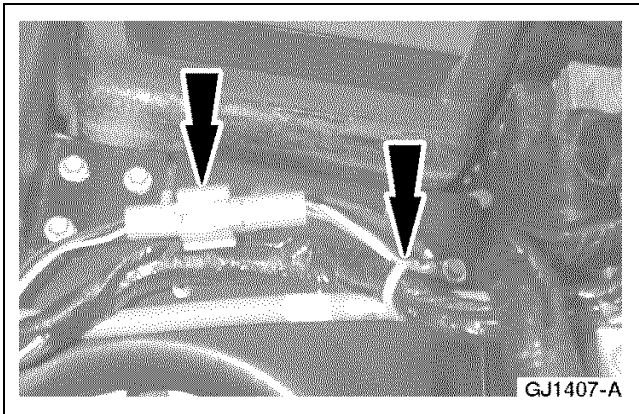

3. Disconnect the recirculating blower electrical connector and cut the zip tie.

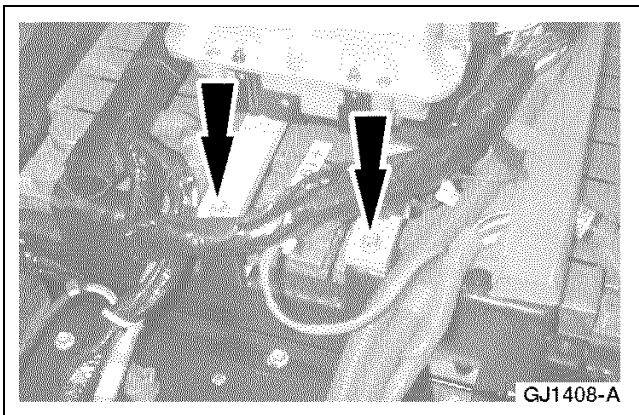

4. Remove the composite bar bolts.

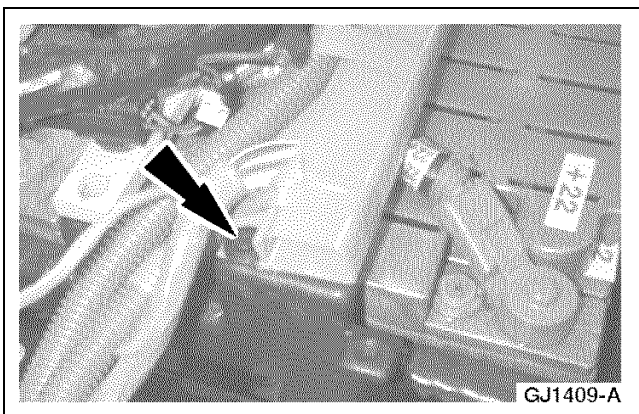

5. Remove the high-voltage harness push pin.

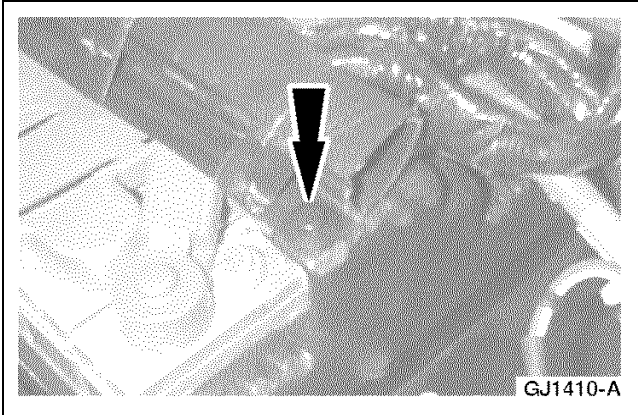
**REMOVAL AND INSTALLATION (Continued)**

6. Remove the low-voltage harness push pin.

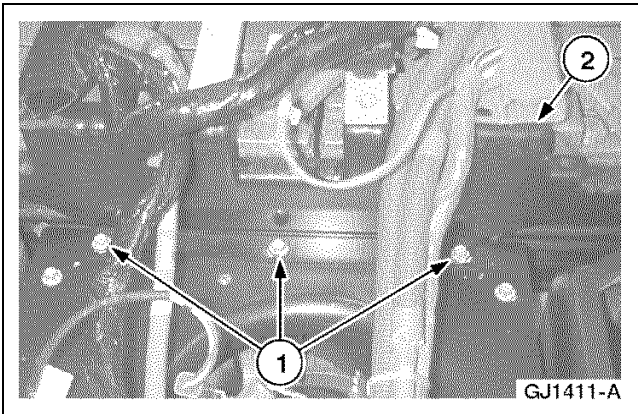

7. Remove the battery hold down bracket.
  - 1 Remove bolts.
  - 2 Remove the bracket.

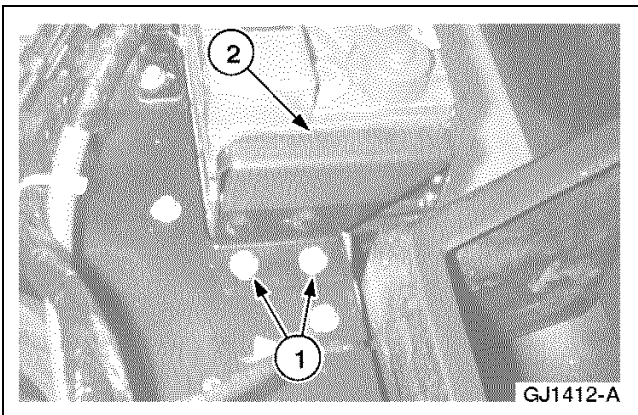

8. Remove the battery hold down bracket.
  - 1 Remove the bolts.
  - 2 Remove the bracket.

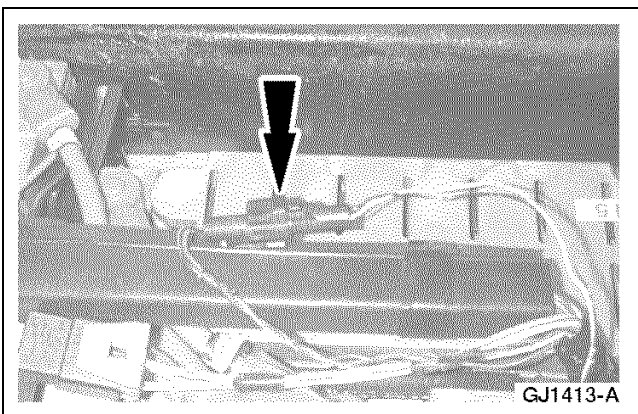

9. Disconnect the blower thermistor electrical connector.

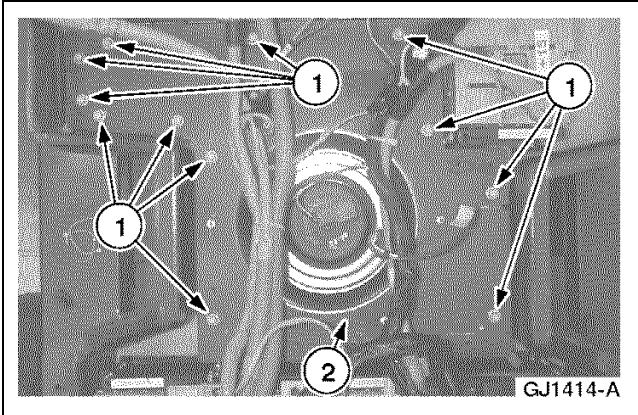
**REMOVAL AND INSTALLATION (Continued)**

10. **NOTE:** Two of the bolts secure hold down brackets to the cover.

Remove the blower cover.

- 1 Remove the bolts.
- 2 Remove the cover.

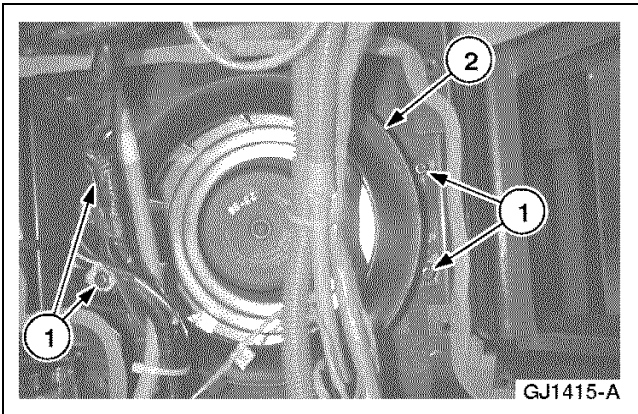

11. **NOTE:** Note the location of the “P” clip that retains the recirculating blower harness.

Remove the recirculating blower.

- 1 Remove the bolts.
- 2 Remove the blower

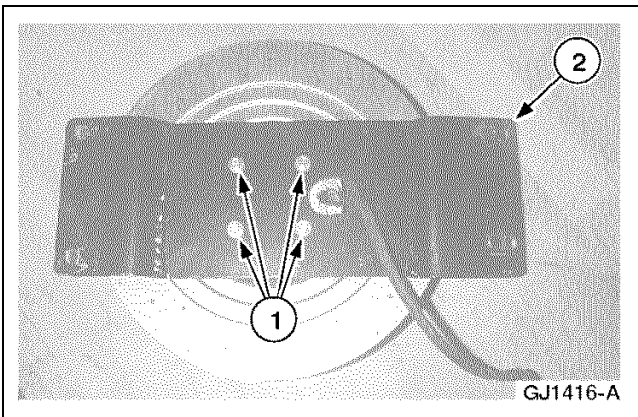

12. Remove the recirculating blower bracket.

- 1 Remove the bolts.
- 2 Remove the bracket.

**Installation**

1. To install, reverse the removal procedure.

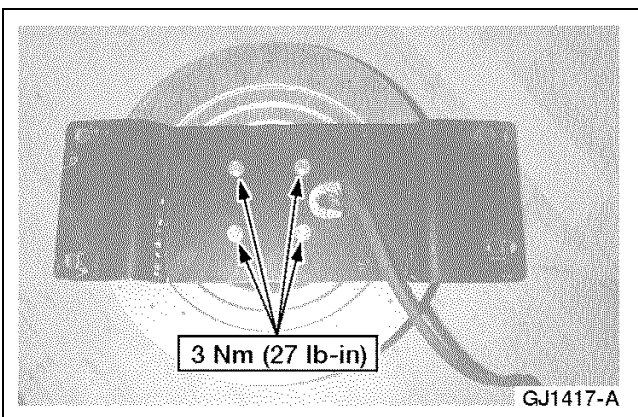

REMOVAL AND INSTALLATION (Continued)

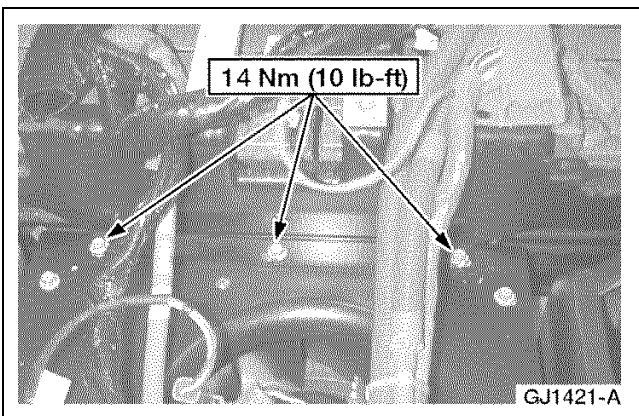
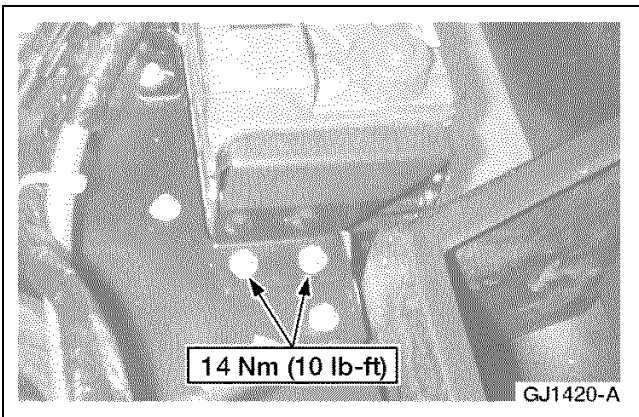
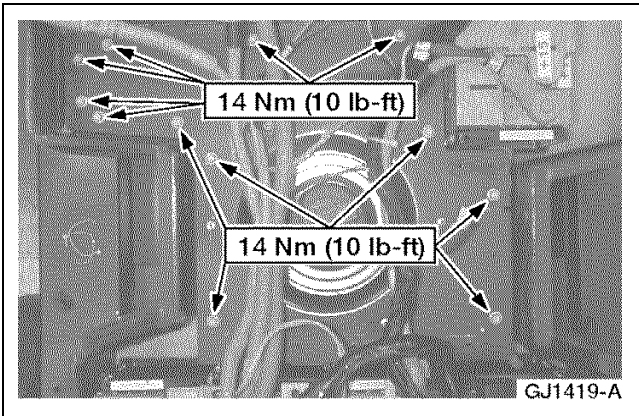
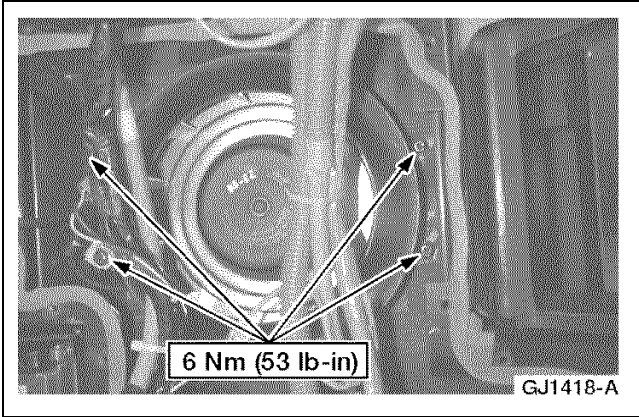

## REMOVAL AND INSTALLATION (Continued)

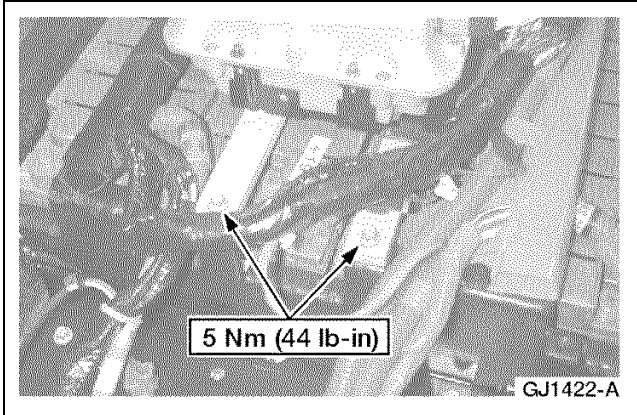

### Traction Battery High Voltage Fuse (250A)

#### Special Tool(s)

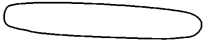
 <p data-bbox="261 1037 358 1058">ST2091-A</p>	<p data-bbox="396 842 724 898">Battery Terminal Cap Opener 418-F215</p>
---	---

#### Removal

1. Remove the traction battery. Refer to [Traction Battery](#).
2.  **WARNING:** The nominal voltage of the traction battery is 300 volts. The buffer zone must be set up and insulated rubber gloves and a face shield must be worn. Failure to follow these precautions may result in severe personal injury or death. Observe the EV-specific precautions. Refer to [Section 100-00](#).
  - 1 Set up the buffer zone.
  - 2 Test and wear the insulated rubber gloves.
  - 3 Wear the face shield.

## REMOVAL AND INSTALLATION (Continued)

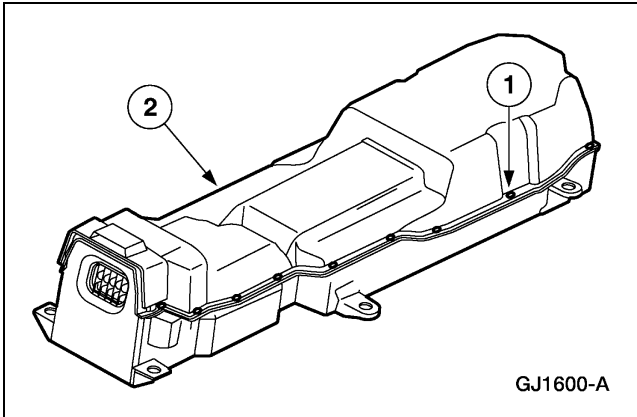

3. Remove the traction battery cover.

- 1 Remove the 22 bolts.

- 2 Remove the cover.

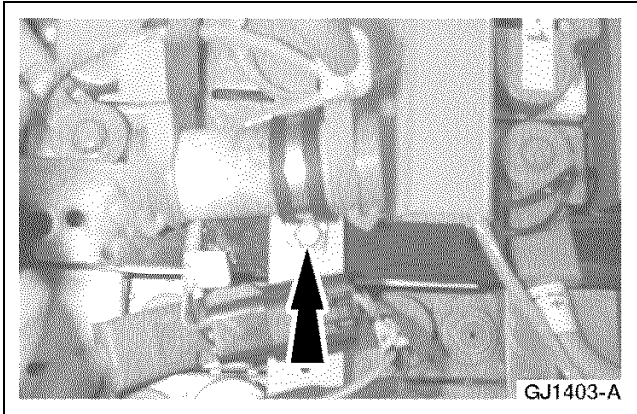

4. Remove the high-voltage fuse clamp bolt.

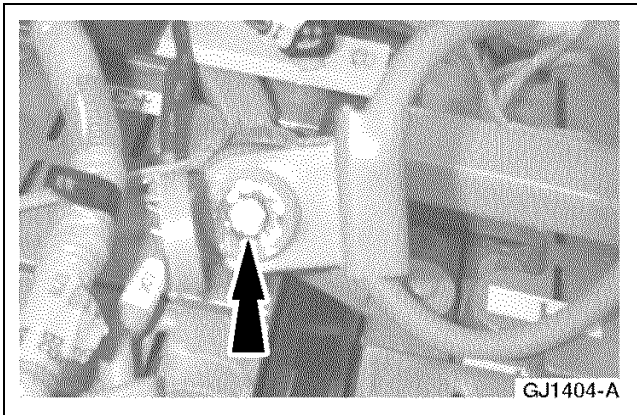

5.  **WARNING: Do not allow the HVJs to touch each other once they are removed from the high-voltage fuse. The HVJs contain high DC voltage and may cause severe personal injury or death.**

Remove the high-voltage fuse.

## Installation

1. To install, reverse the removal procedure.
  - Fill the area around the high-voltage fuse bolts with Nyogel.
  - Apply Loctite 242 to the 22 traction battery cover bolts.

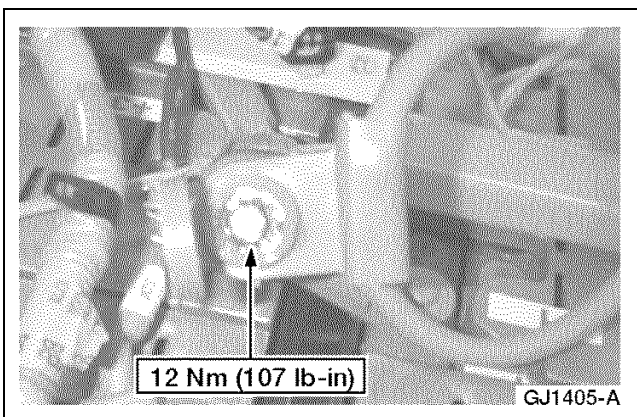

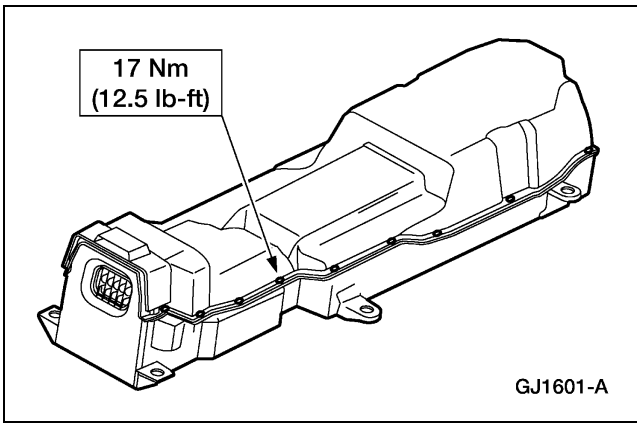
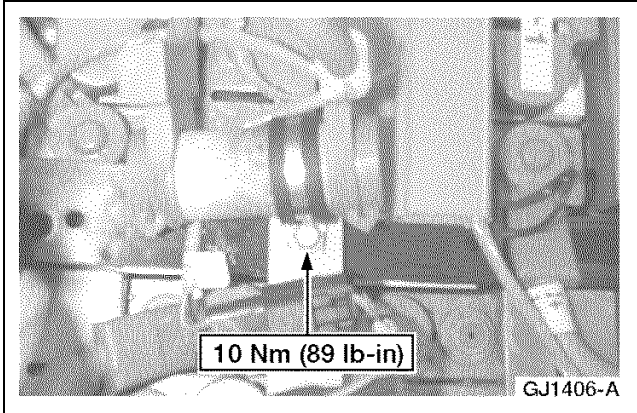
**REMOVAL AND INSTALLATION (Continued)****Traction Battery Temperature Sensor****Removal**

1. Remove the traction battery. Refer to [Traction Battery](#).

2.  **WARNING:** The nominal voltage of the traction battery is 300 volts. The buffer zone must be set up and insulated rubber gloves and a face shield must be worn. Failure to follow these precautions may result in severe personal injury or death.

Observe the EV-specific precautions. Refer to [Section 100-00](#).

- 1 Set up the buffer zone.
- 2 Test and wear the insulated rubber gloves.
- 3 Wear the face shield.



## REMOVAL AND INSTALLATION (Continued)

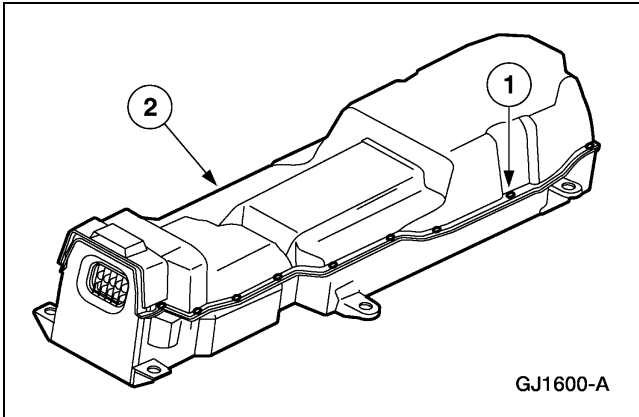

3. Remove the traction battery cover.
  - 1 Remove the 22 bolts.
  - 2 Remove the cover.

4. **NOTE:** There are two thermistors (temperature sensors) located on modules 3, 12, and 18. There is also one mounted in the cover of the recirculating blower.

**NOTE:** The traction battery module procedure found in the General Procedures section does not have to be followed for thermistor removal and installation.

To remove a thermistor for a module, remove the module. Refer to the appropriate module removal and installation procedure.

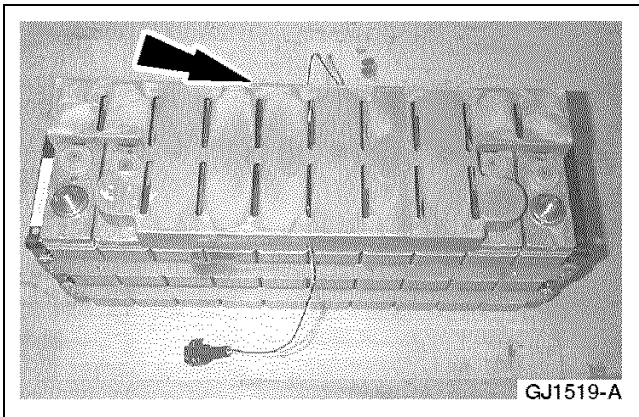

5. Remove the module cover.

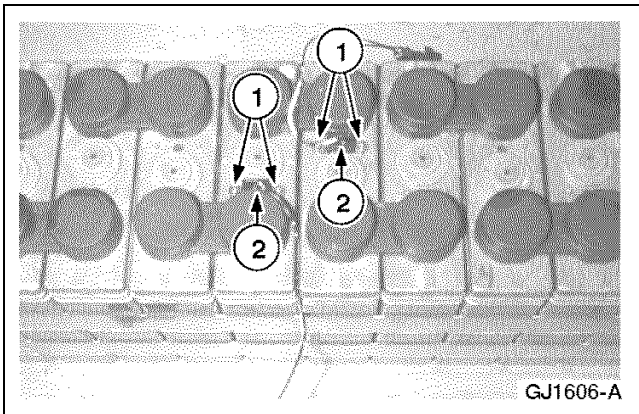

6. Remove the thermistor.
  - 1 Remove the clips.
  - 2 Remove the thermistor.

## REMOVAL AND INSTALLATION (Continued)

### Installation

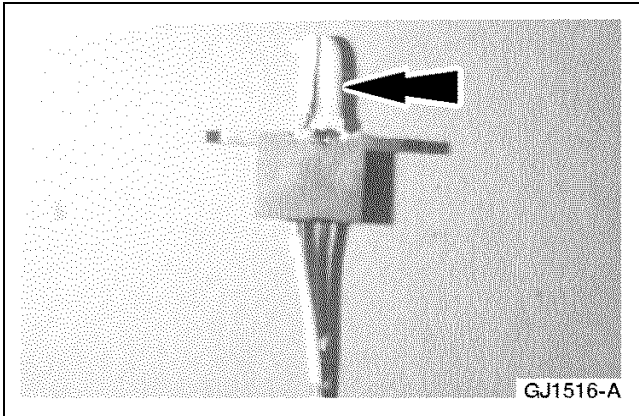

1. Apply a thin layer of thermal grease to the thermistor.

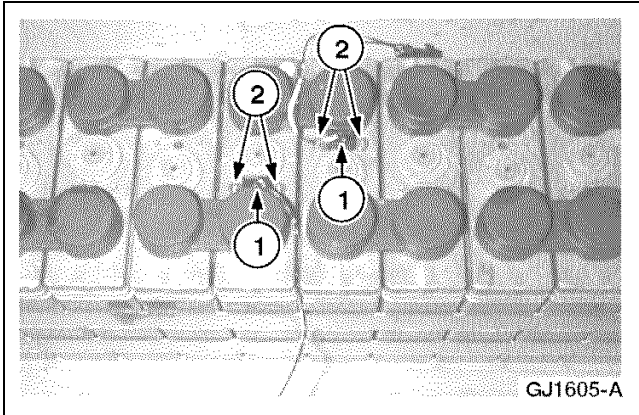

2. Install the thermistor.
  - 1 Install the thermistor.
  - 2 Install the clips.

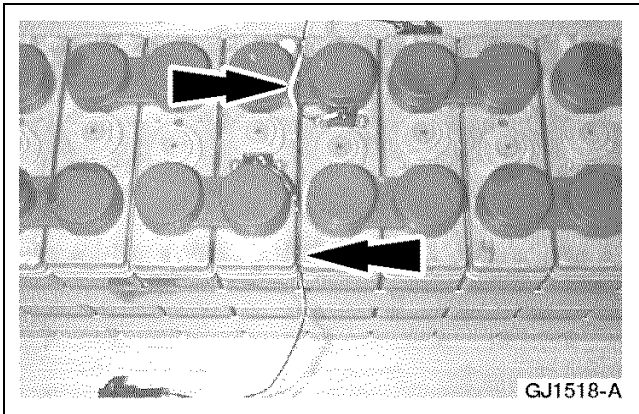

3. **NOTE:** If replacing module 12 thermistors, route both of the wires to the inboard side of the module.  
Route the thermistor wires along the space between the two center modules.

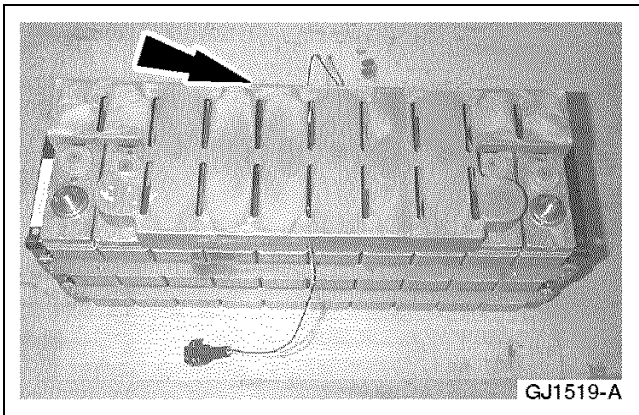

4. Install the module cover.

**REMOVAL AND INSTALLATION (Continued)**

5. Install the module. Refer to the appropriate procedure.
6. Install the traction battery cover.
  - Install the 22 bolts.

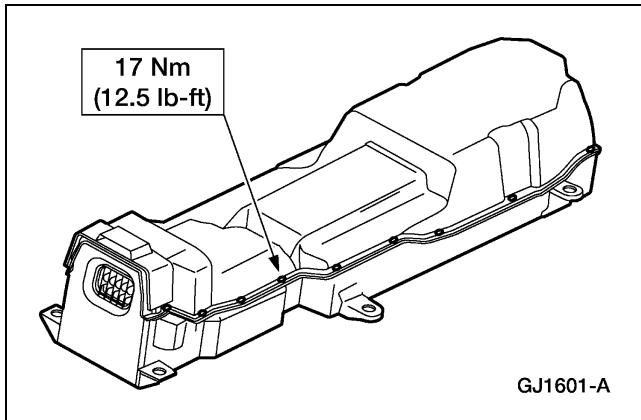

**Traction Battery Module —Modules 2-6**

**Special Tool(s)**

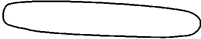
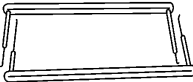
 <p>ST2097-A</p>	<p>Battery Post Torque Wrench 307-026</p>
 <p>ST2091-A</p>	<p>Battery Terminal Cap Opener 418-F215</p>
 <p>ST2345-A</p>	<p>Battery Handles 414-F001</p>

**REMOVAL AND INSTALLATION (Continued)****Removal**

1.  **CAUTION: Module replacement requires a special charging procedure that is incorporated into the removal and installation of the module. To replace a faulty module, follow the Traction Battery Module Replacement located in the General Procedures section of this manual.**

Refer to [Traction Battery Module Replacement](#) to begin module replacement.

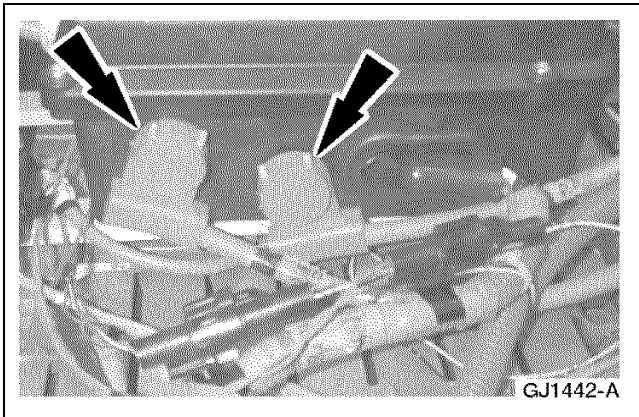

2.  **CAUTION: Disconnect only one HVJ at a time.**

Disconnect the HVJs from the contactor box.

- Open the cap.
- Remove and discard the nut.

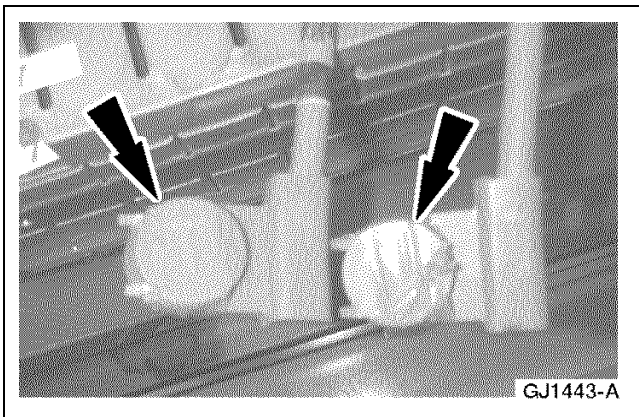

3. Wrap the HVJ ends with orange electrical tape.

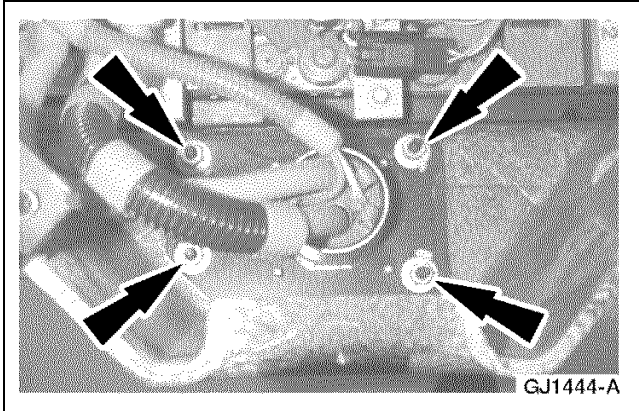

4. Remove the two-pin high-voltage connector nuts.

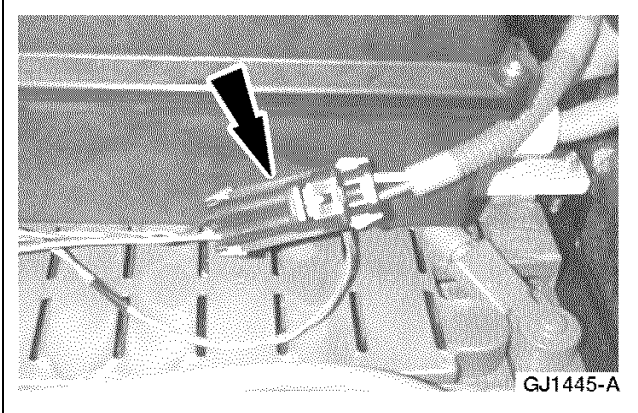
**REMOVAL AND INSTALLATION (Continued)**

5. Disconnect the high-voltage interlock electrical connector.

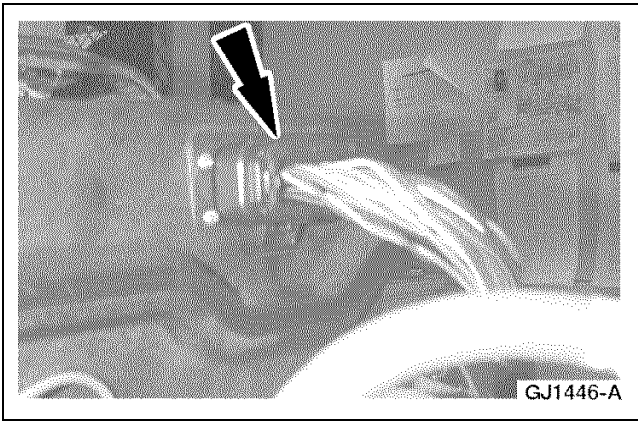

6. Disconnect the low-voltage electrical connector.

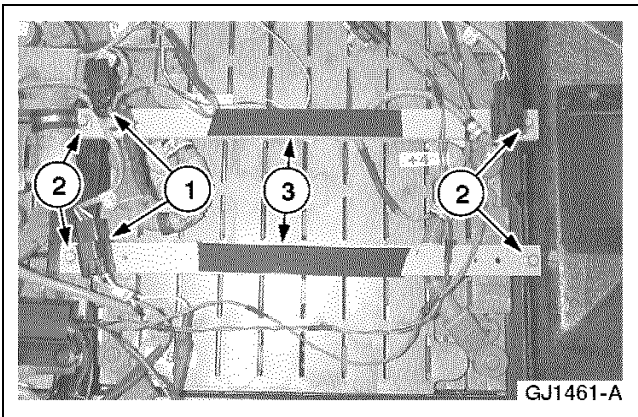

7. Position the contactor box towards the front of the traction battery.
8. Remove the composite bars.
  - 1 Unclip the connectors.
  - 2 Remove the bolts.
  - 3 Remove the composite bars.

## REMOVAL AND INSTALLATION (Continued)

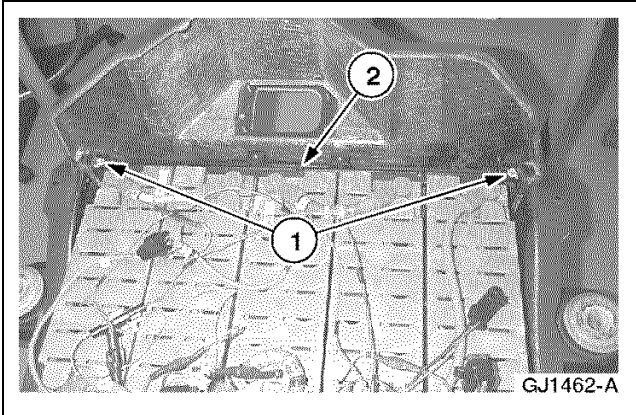

9. Remove the rear module hold down bracket.
  - 1 Remove the bolts.
  - 2 Remove the hold down.

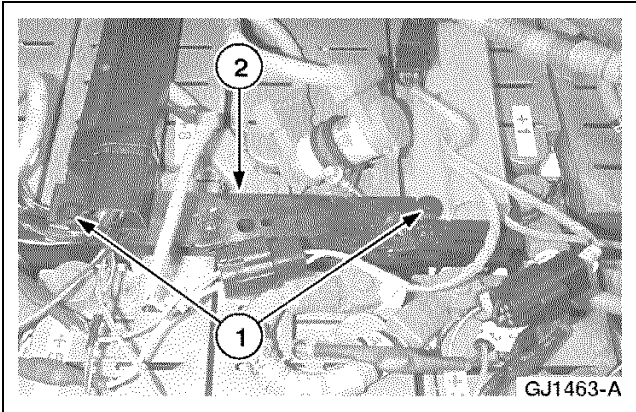

10. Unclip the battery hold down tie bar.
  - 1 Remove the pushpins.
  - 2 Unclip the cover.

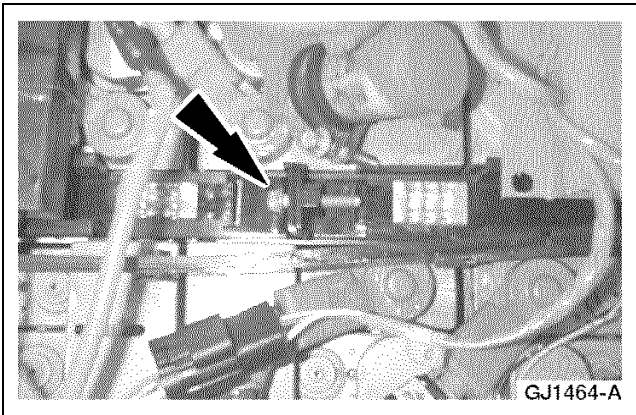

11. Remove the battery hold down strap bolt and pull the straps back off the battery hold down tie bar.

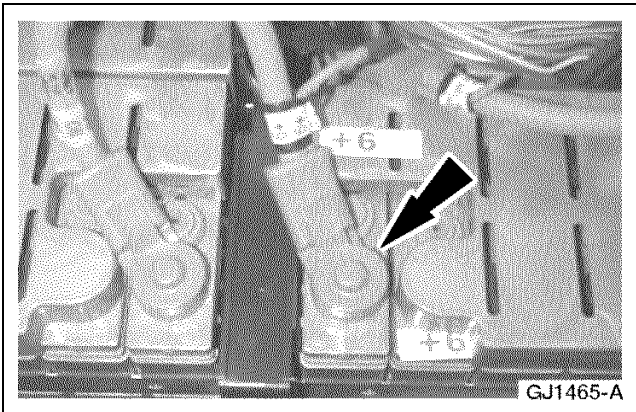

12. Disconnect the 6+ HVJ.
  - Remove and discard the nut.

## REMOVAL AND INSTALLATION (Continued)

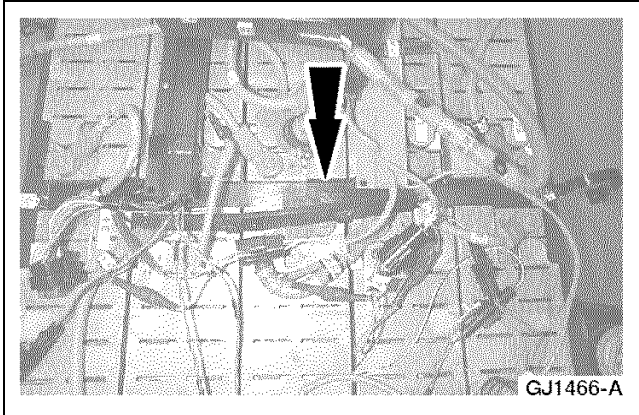

13. Remove the battery hold down tie bar.

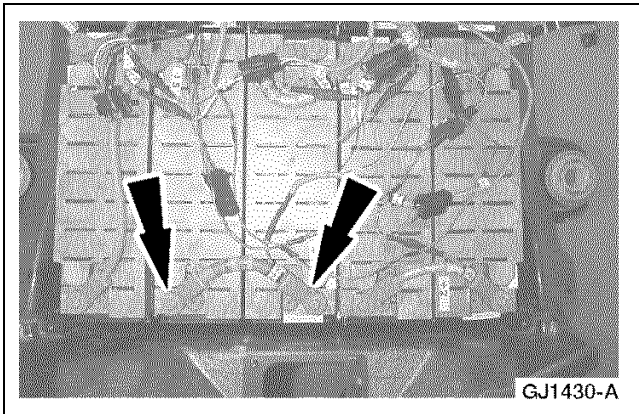

14. Disconnect the necessary module.

- If replacing module 3, disconnect the 2 two thermistor electrical connectors.
- Disconnect the HVJ cables and discard the nuts.

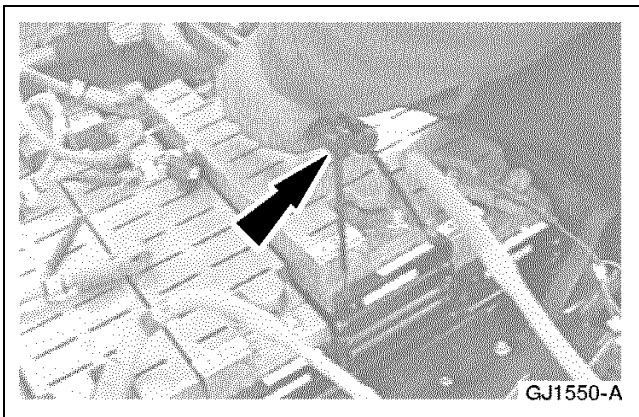

15. Using the special tool, remove the module.

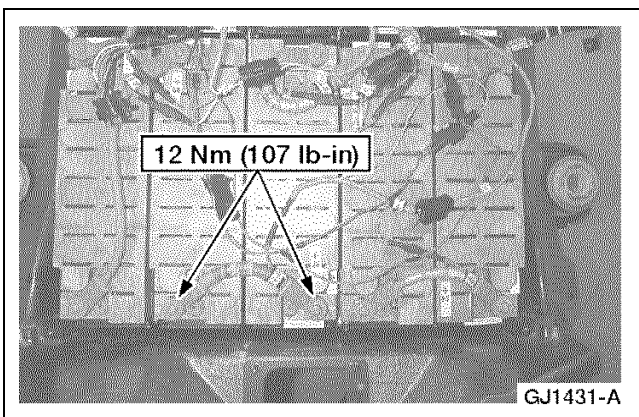

## Installation

1. **NOTE:** The arrow on the battery hold down tie bars must be pointed towards the front of the traction battery.

To install, reverse the removal procedure.

- Fill the high-voltage jumper connectors with Nyogel after final tightening of the nuts.

REMOVAL AND INSTALLATION (Continued)

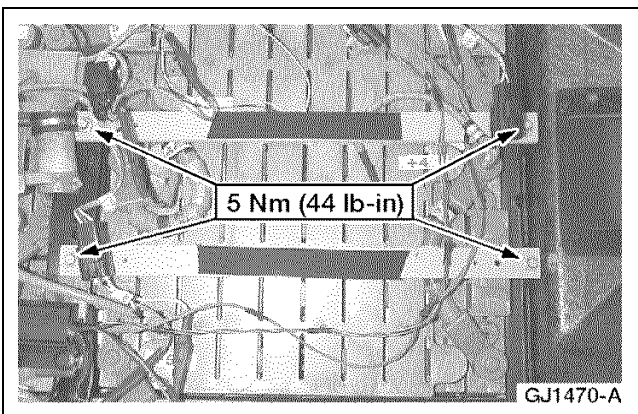
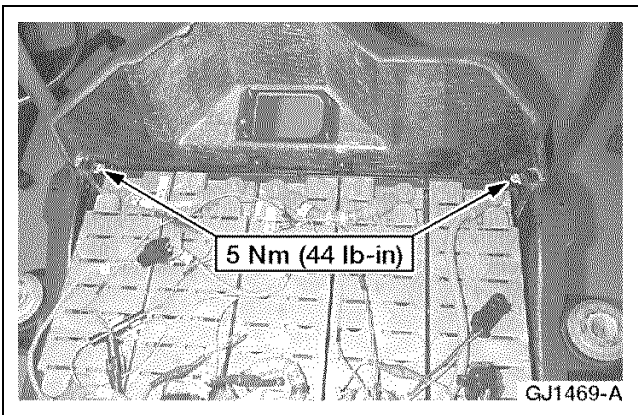
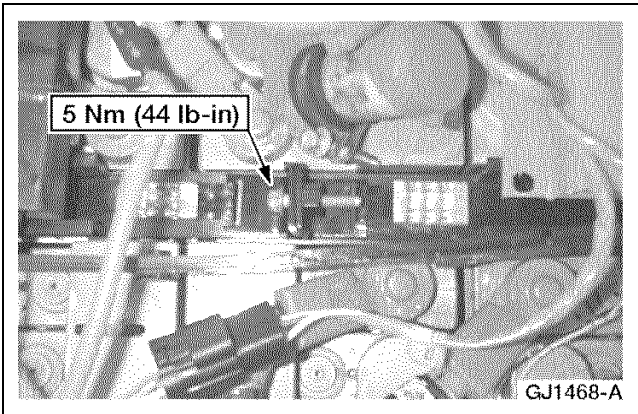
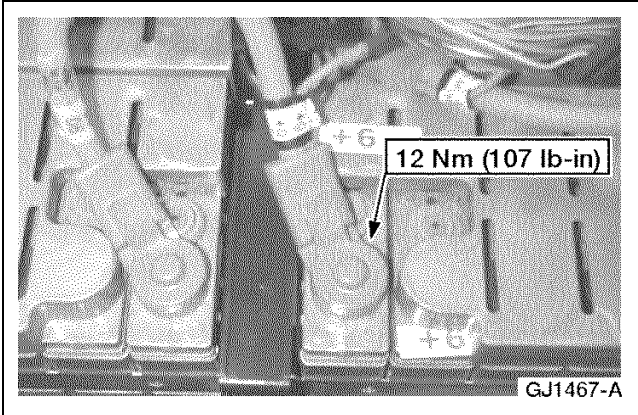



**REMOVAL AND INSTALLATION (Continued)**

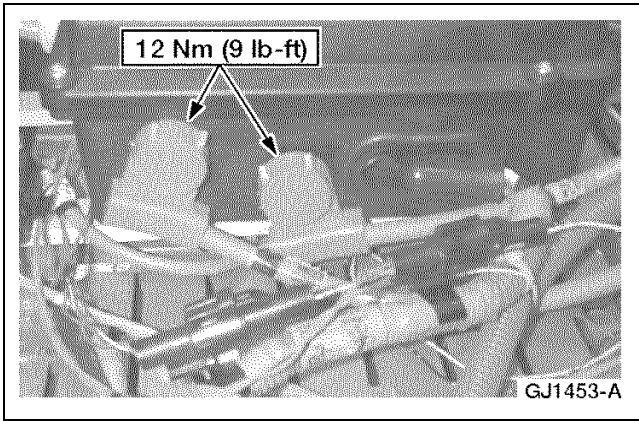
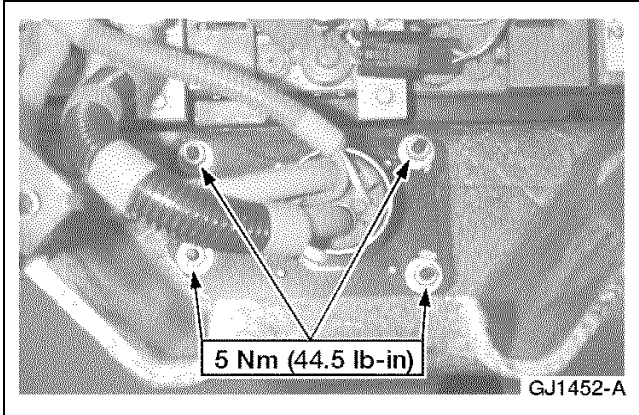

**Traction Battery Module —Modules 1, 7, 8, 9, 25**

**Special Tool(s)**

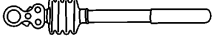
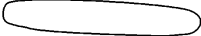
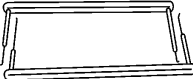
 <p>ST2097-A</p>	<p>Battery Post Torque Wrench 307-026</p>
 <p>ST2091-A</p>	<p>Battery Terminal Cap Opener 418-F215</p>
 <p>ST2345-A</p>	<p>Battery Handles 414-F001</p>

**REMOVAL AND INSTALLATION (Continued)****Removal**

1. This procedure contains steps specific to the modules listed. Do not start with this procedure. Refer to [Traction Battery Module Replacement](#) to begin module replacement.

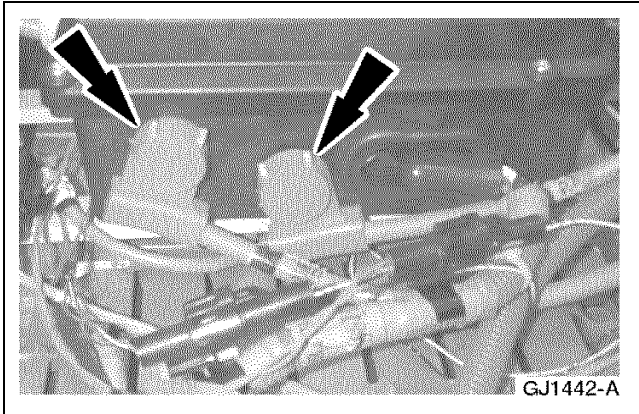

2.  **CAUTION: Disconnect only one HVJ at a time.**

Disconnect the HVJs from the contactor box.

- Open the cap.
- Remove and discard the nut.

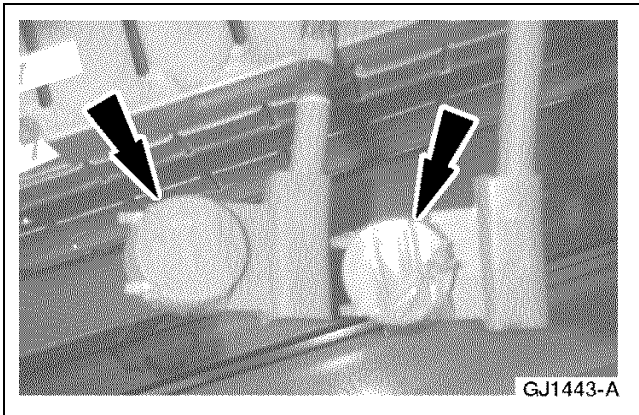

3. Wrap the HVJ ends with orange electrical tape.

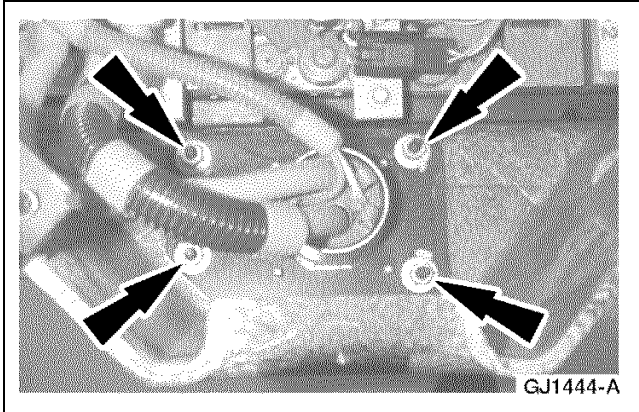

4. Remove the two-pin high-voltage connector nuts.

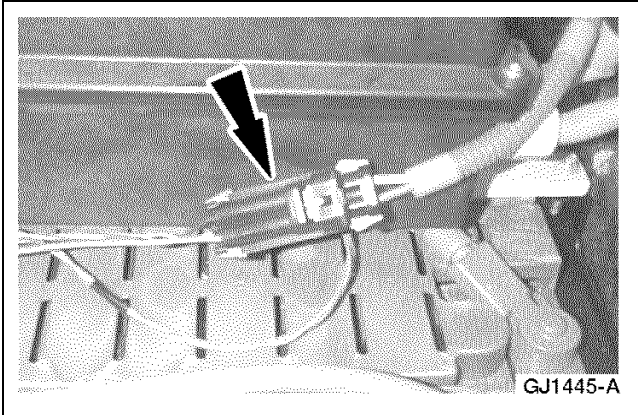
**REMOVAL AND INSTALLATION (Continued)**

5. Disconnect the high-voltage interlock electrical connector.

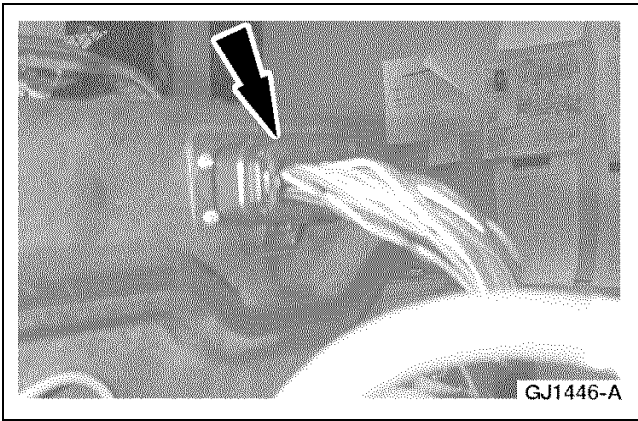

6. Disconnect the low-voltage electrical connector.

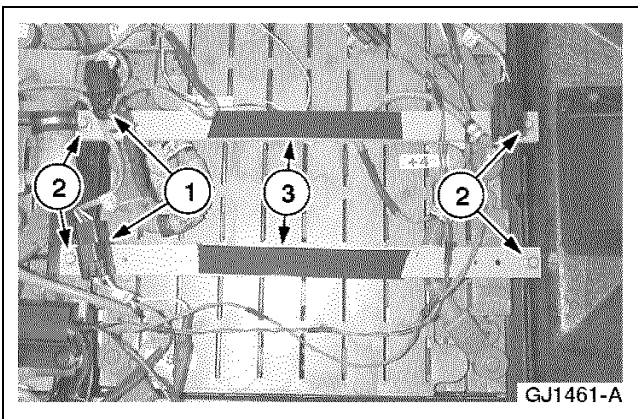

7. Position the contactor box towards the front of the traction battery.
8. Remove the composite bars.
  - 1 Unclip the connectors.
  - 2 Remove the bolts.
  - 3 Remove the composite bars.

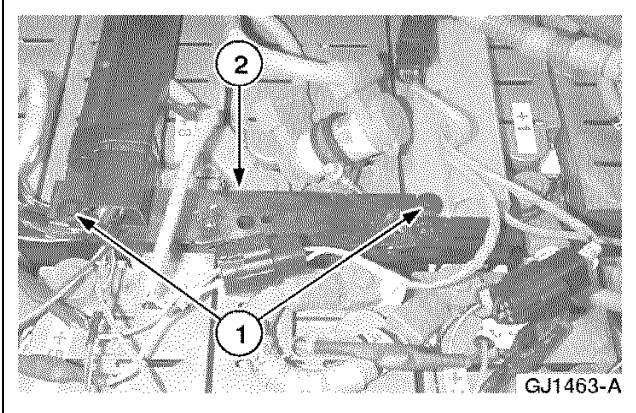
**REMOVAL AND INSTALLATION (Continued)**

9. Unclip the battery hold down tie bar cover.
  - 1 Remove the pushpins.
  - 2 Unclip the cover.

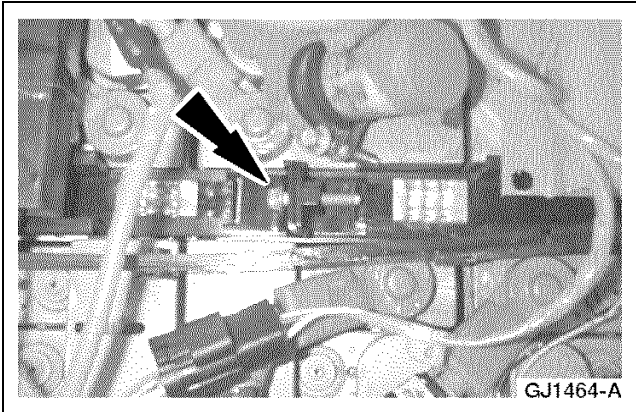

10. Remove the battery hold down strap bolt and pull the straps back.

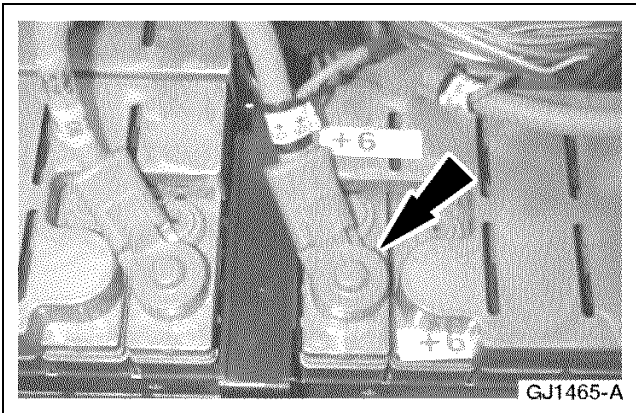

11. Disconnect the 6+ HVJ.
  - Remove and discard the nut.

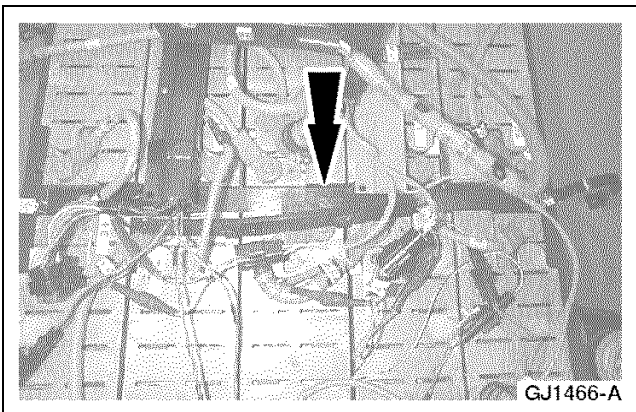

12. Remove the battery hold down tie bar.

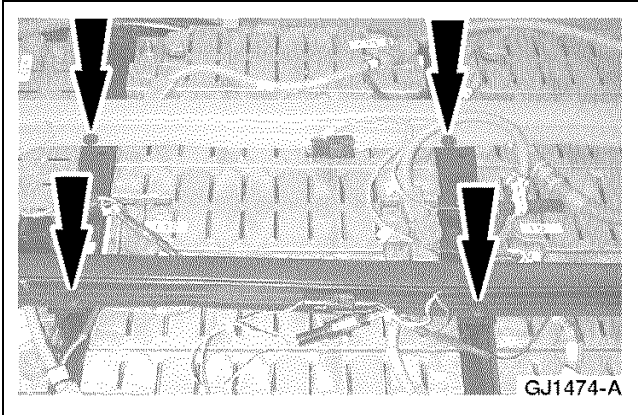
**REMOVAL AND INSTALLATION (Continued)**

13. Remove the low and high-voltage harness push pins.

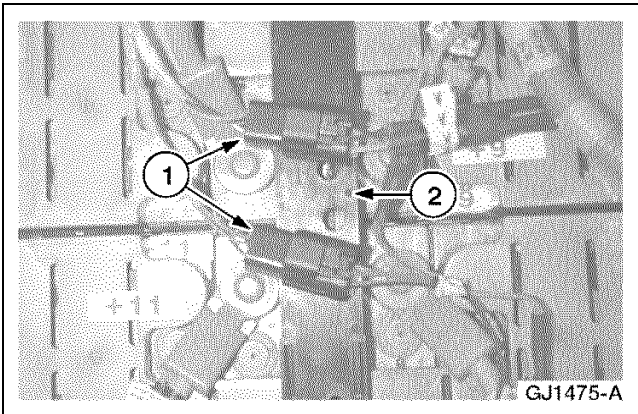

14. Unclip the battery hold down tie bar cover.
  - 1 Unclip the sense lead connectors from the cover.
  - 2 Unclip the cover.

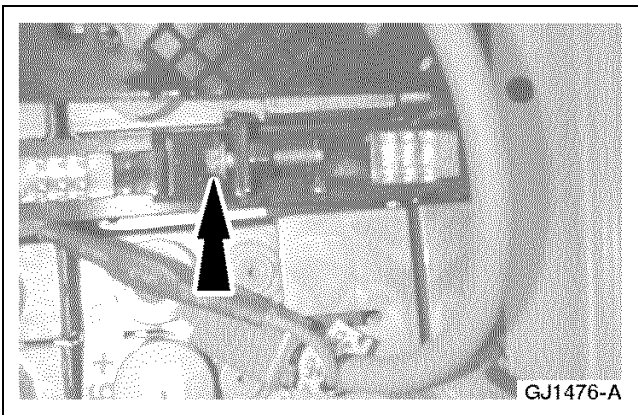

15. Remove the battery hold down strap bolt and pull the straps back off the battery hold down tie bar.

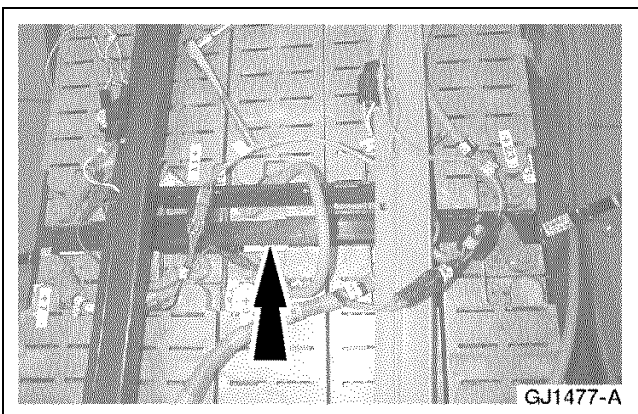

16. Remove the battery hold down tie bar.

## REMOVAL AND INSTALLATION (Continued)

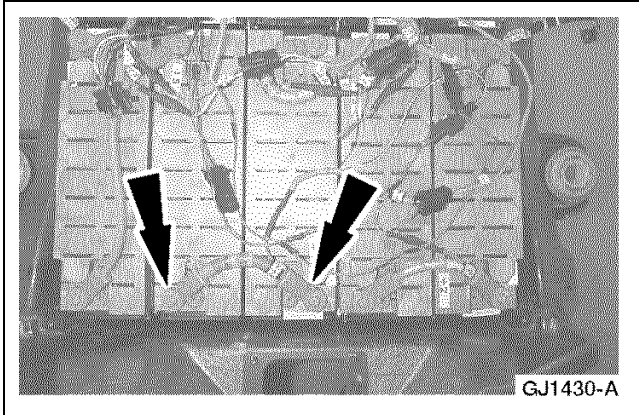

17. Disconnect the necessary module.
  - Disconnect the HVJ cables and discard the nuts.

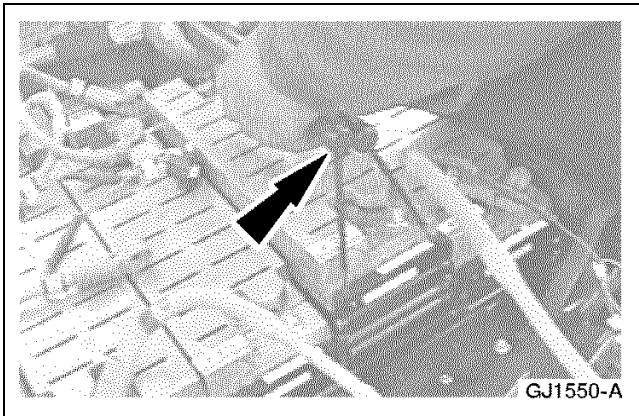

18. Using the special tool, remove the module.

## Installation

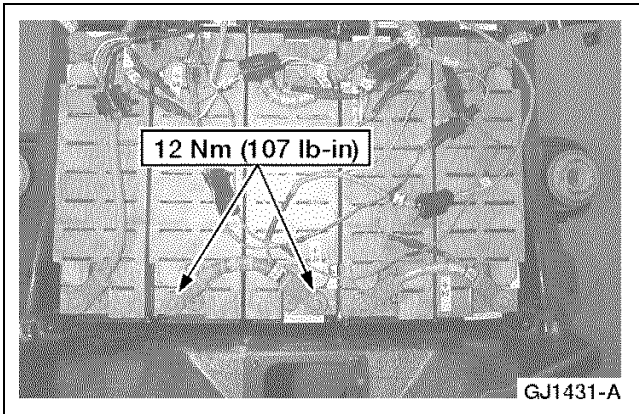

1. **NOTE:** The arrow on the battery hold down tie bars must be pointed towards the front of the traction battery.

To install, reverse the removal procedure.

- Fill the high-voltage jumper connectors with Nyogel after final tightening of the nuts.

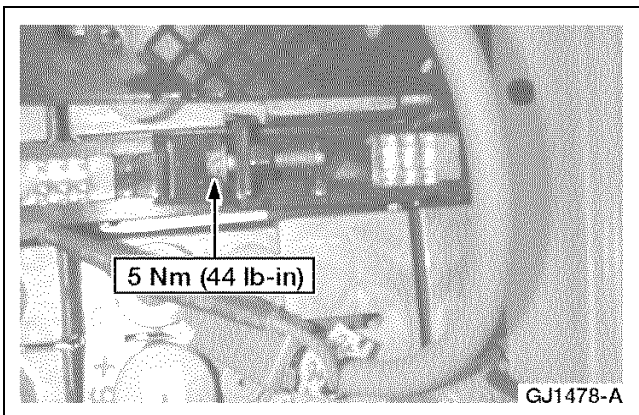

**REMOVAL AND INSTALLATION (Continued)**

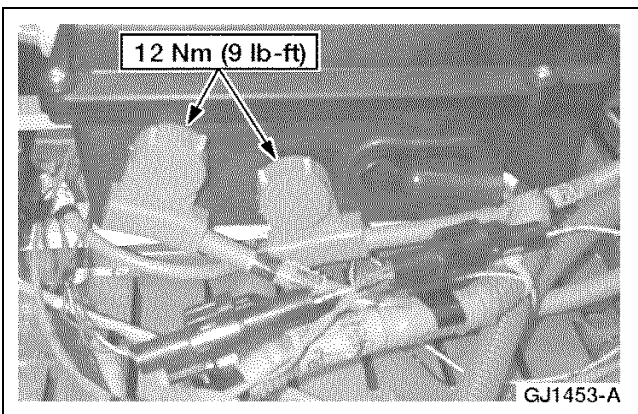
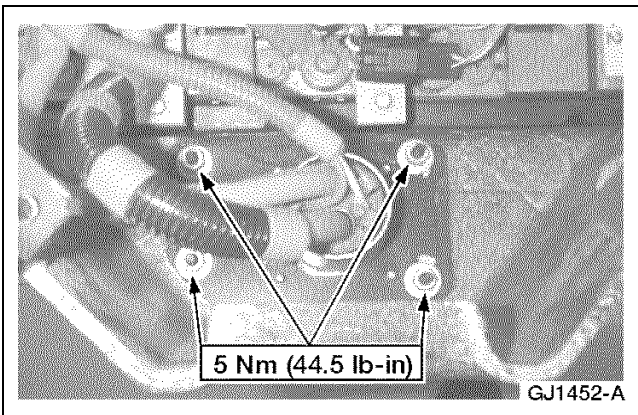
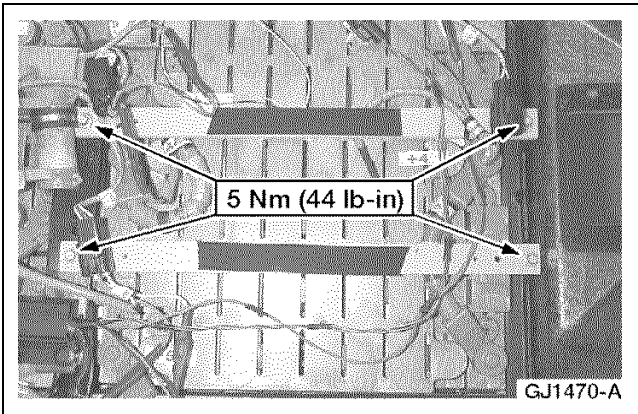
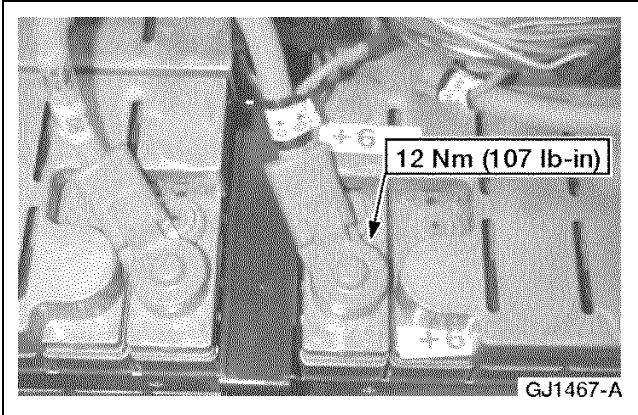

**REMOVAL AND INSTALLATION (Continued)****Traction Battery Module —Modules 10, 11, 12, 23, 24****Special Tool(s)**

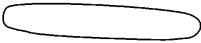
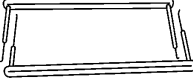
 <p>ST2097-A</p>	<p>Battery Post Torque Wrench 307-026</p>
 <p>ST2091-A</p>	<p>Battery Terminal Cap Opener 418-F215</p>
 <p>ST2345-A</p>	<p>Battery Handles 414-F001</p>

**Removal**

1. This procedure contains steps specific to the modules listed. Do not start with this procedure. Refer to [Traction Battery Module Replacement](#) to begin module replacement.
2. Remove the high and low-voltage harness push pins.

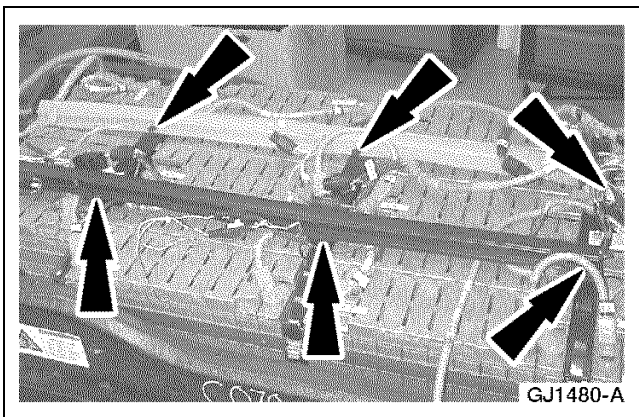

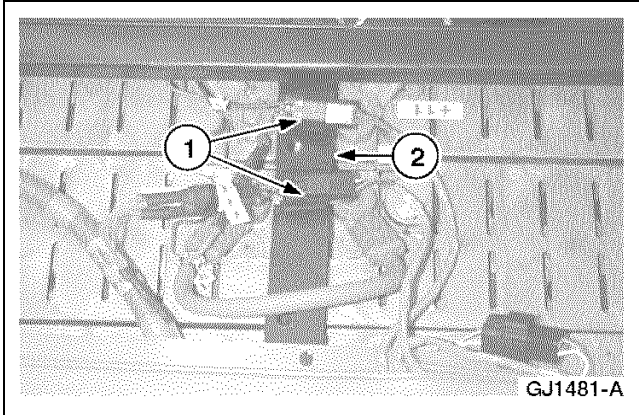

**REMOVAL AND INSTALLATION (Continued)**

3. Unclip the battery hold down tie bar cover.
  - 1 Unclip and disconnect the sensor lead electrical connectors.
  - 2 Unclip the cover.

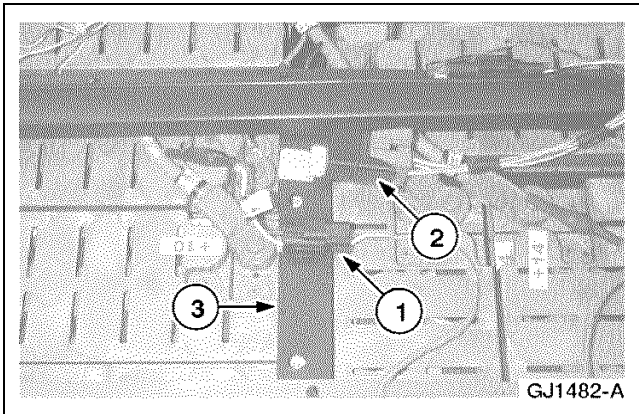

4. Unclip the battery hold down tie bar cover.
  - 1 Unclip and disconnect the sensor lead electrical connector.
  - 2 Unclip the relay.
  - 3 Unclip the cover.

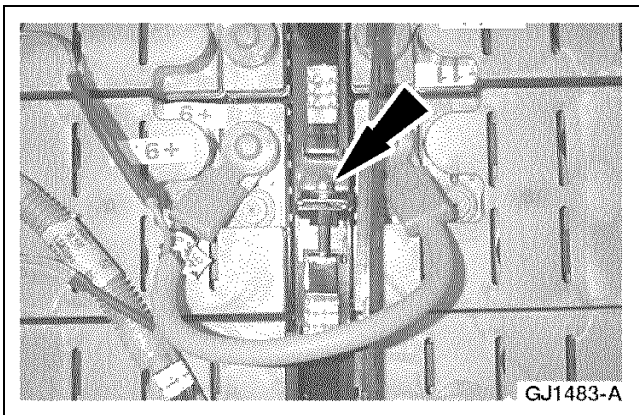

5. Remove the battery hold down strap bolt and pull the straps back off the battery hold down tie bar.

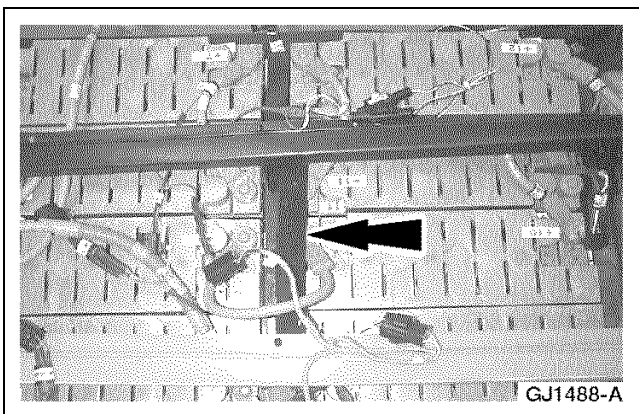

6. Remove the battery hold down tie bar.

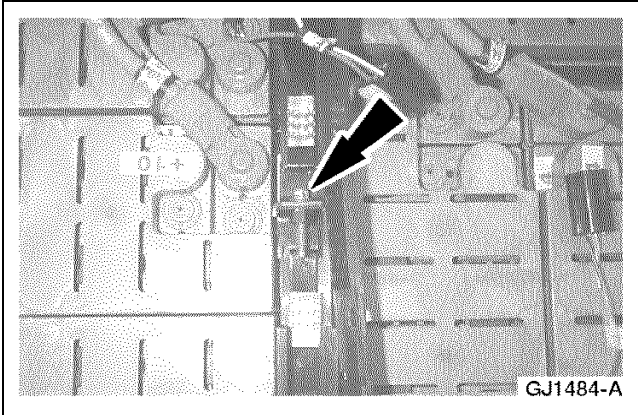
**REMOVAL AND INSTALLATION (Continued)**

7. Remove the battery hold down strap bolt and pull the straps back off the battery hold down tie bar.

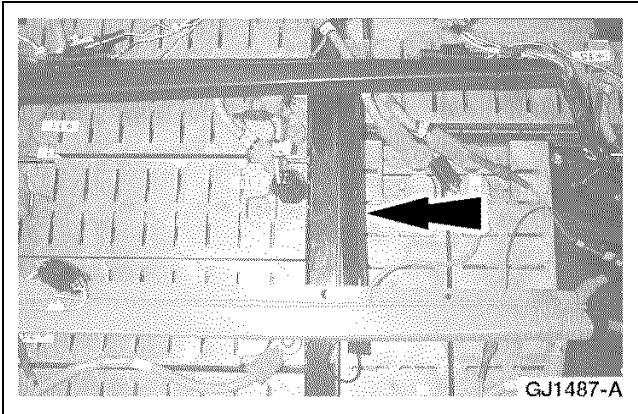

8. Remove the battery hold down tie bar.

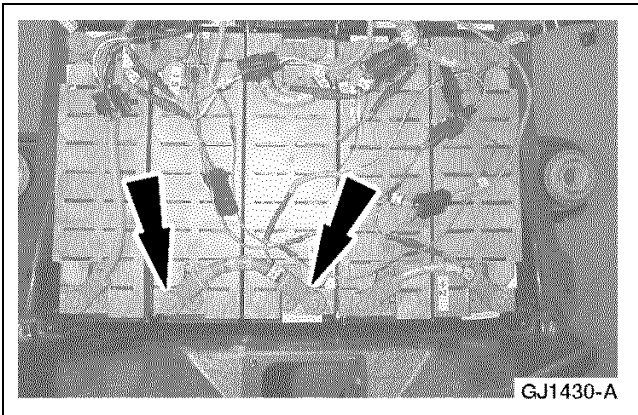

9. **NOTE:** If removing module 12, disconnect the two thermistors.

Disconnect the necessary module.

- Disconnect the HVJ cables and discard the nuts.

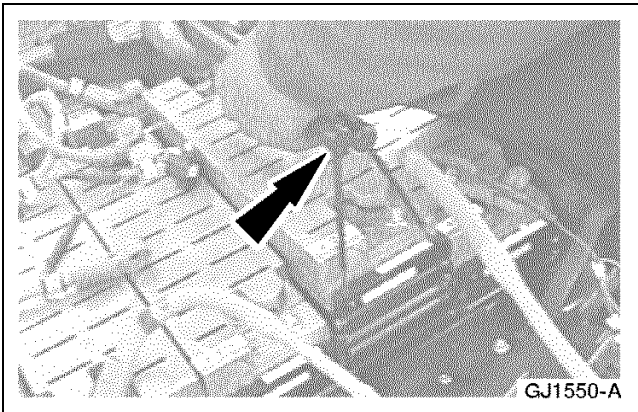

10. Using the special tool, remove the module.

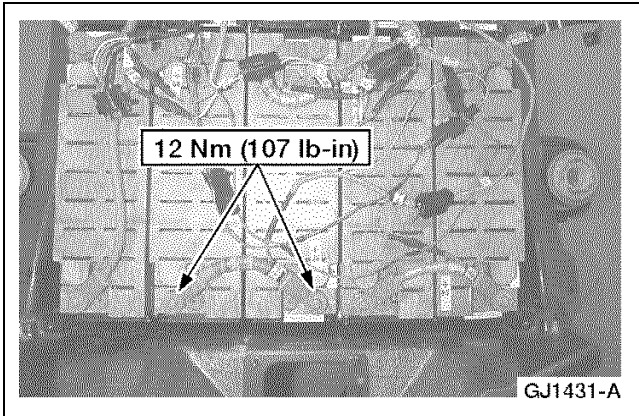
**REMOVAL AND INSTALLATION (Continued)****Installation**



1. **NOTE:** The arrow on the battery hold down tie bars must be pointed towards the front of the traction battery.

To install, reverse the removal procedure.

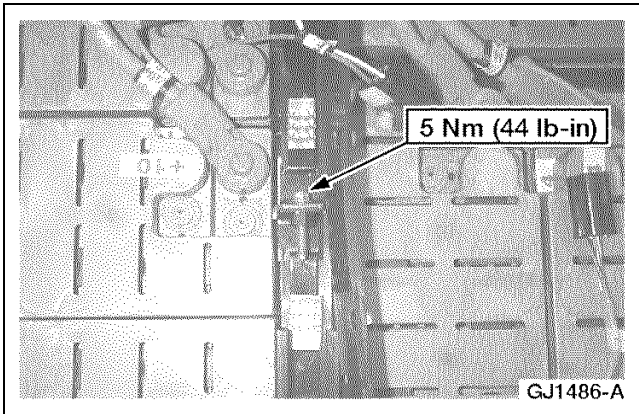
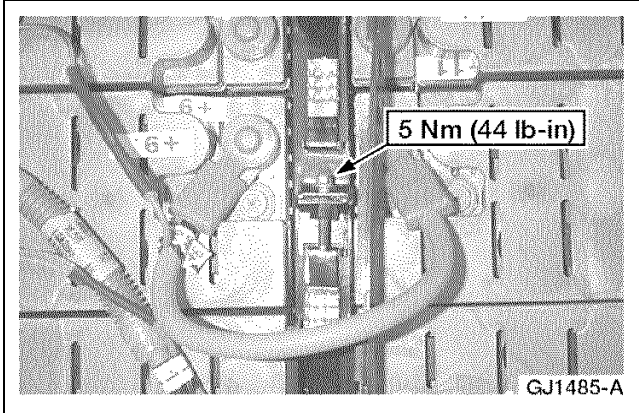
- Fill the high-voltage jumper connectors with Nyogel after final tightening of the nuts.

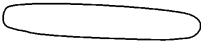

**REMOVAL AND INSTALLATION (Continued)****Traction Battery Module —Modules 13-15****Special Tool(s)**

 <p>ST2097-A</p>	<p>Battery Post Torque Wrench 307-026</p>
 <p>ST2091-A</p>	<p>Battery Terminal Cap Opener 418-F215</p>
 <p>ST2345-A</p>	<p>Battery Handles 414-F001</p>

**Removal****Modules 13-15**

1. This procedure contains steps specific to the modules listed. Do not start with this procedure. Refer to [Traction Battery Module Replacement](#) to begin module replacement.
2. Remove the high and low-voltage harness push pins.

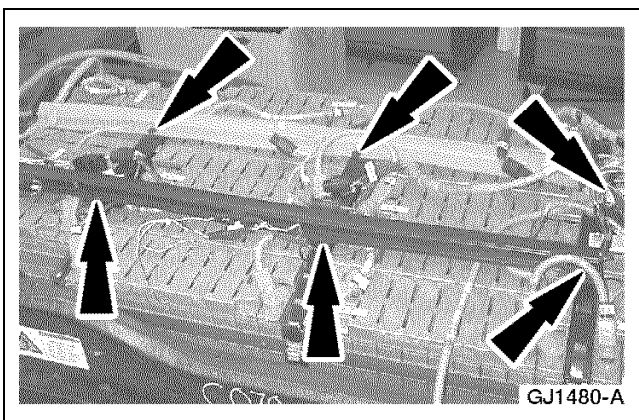

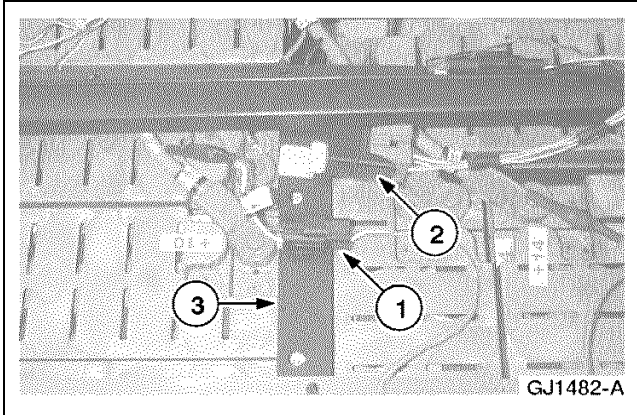
**REMOVAL AND INSTALLATION (Continued)**

3. Unclip the battery hold down tie bar cover.
  - 1 Unclip and disconnect the sensor lead electrical connector.
  - 2 Unclip the relay.
  - 3 Unclip the cover.

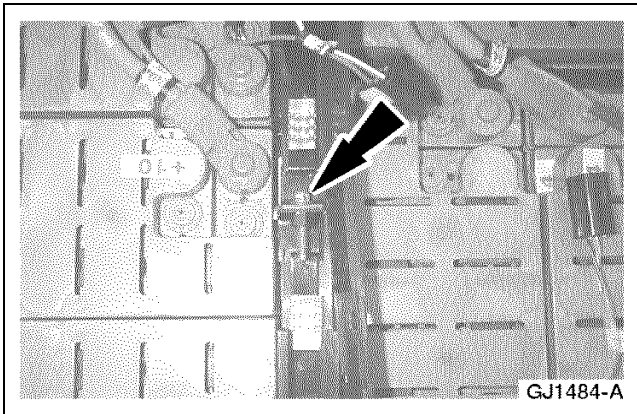

4. Remove the battery hold down strap bolt and pull the straps back off the battery hold down tie bar.

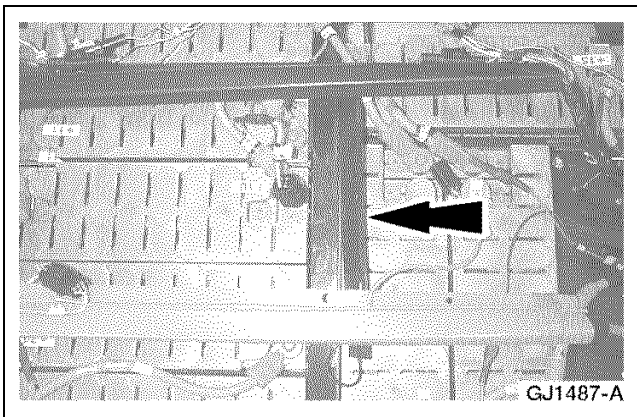

5. Remove the battery hold down tie bar.

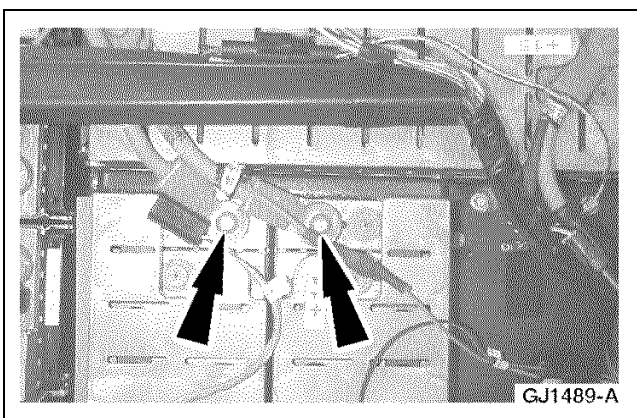
**Modules 13,14**

6. Disconnect the 14+ and 13- HVJs.
  - Disconnect the HVJ cables and discard the nuts.

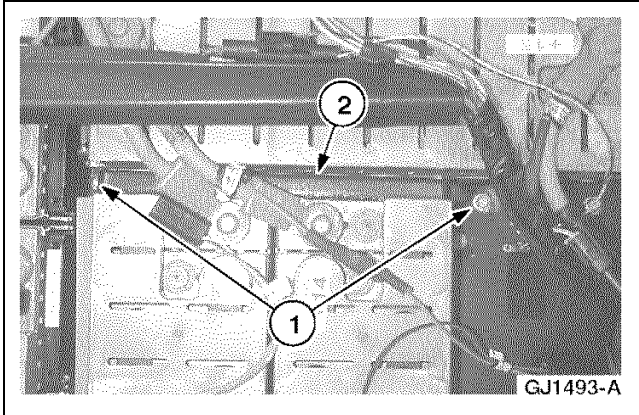
**REMOVAL AND INSTALLATION (Continued)**

7. Remove the battery hold down bracket.
  - 1 Remove the bolts.
  - 2 Remove the bracket.

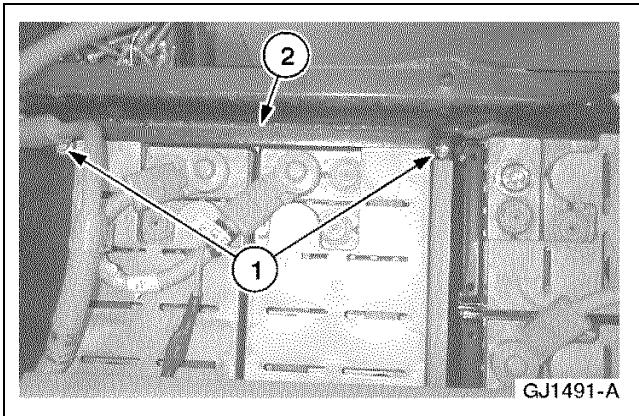

8. Remove the battery hold down bracket.
  - 1 Remove the bolts.
  - 2 Remove the bracket.

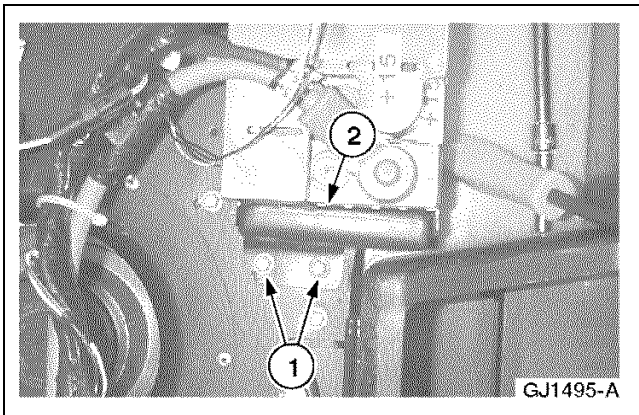

9. Remove the battery hold down bracket.
  - 1 Remove the bolts.
  - 2 Remove the bracket.

**Module 15**

## REMOVAL AND INSTALLATION (Continued)

### Modules 13-15

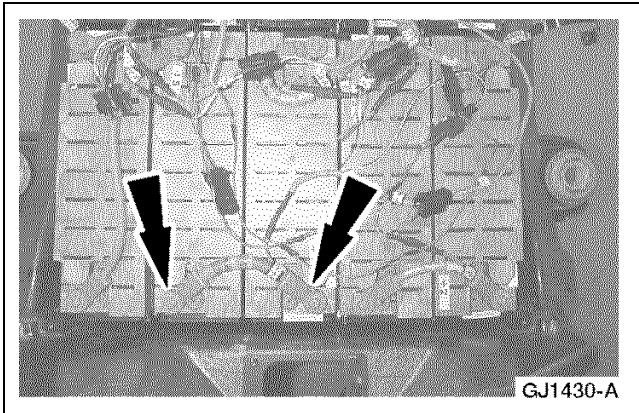

10. Disconnect the necessary module.
  - Disconnect the HVJ cables and discard the nuts.

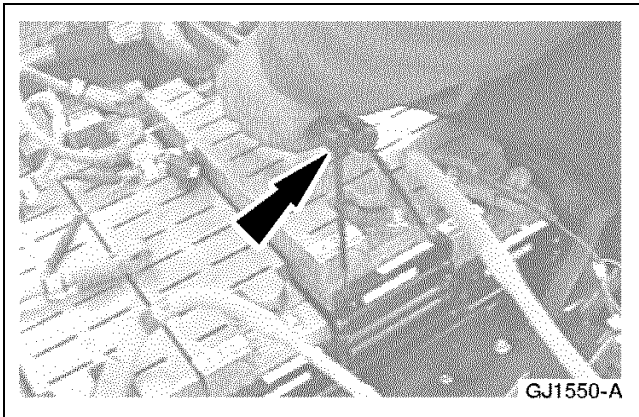

11. Using the special tool, remove the module.

### Installation

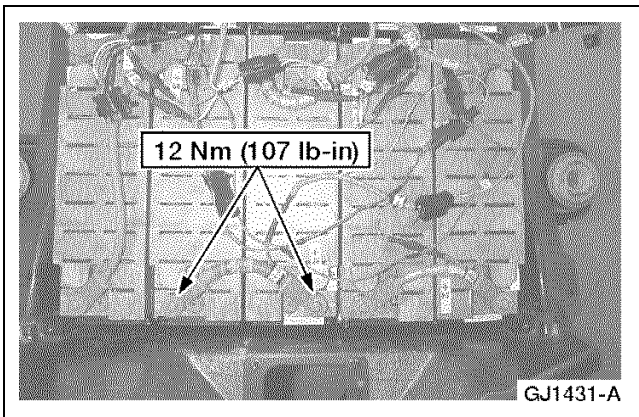

1. **NOTE:** The arrow on the battery hold down tie bars must be pointed towards the front of the traction battery.

To install, reverse the removal procedure.

- Fill the high-voltage jumper connectors with Nyogel after final tightening of the nuts.

REMOVAL AND INSTALLATION (Continued)

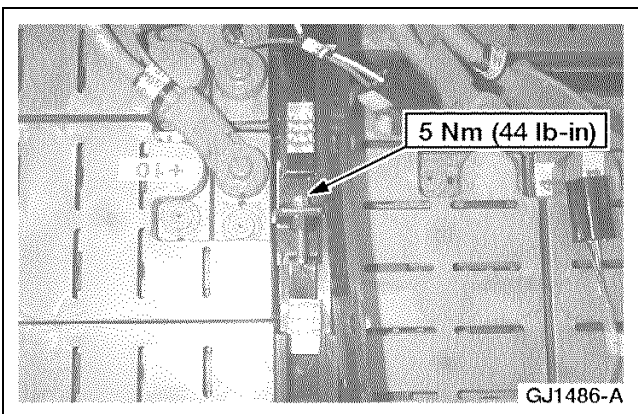
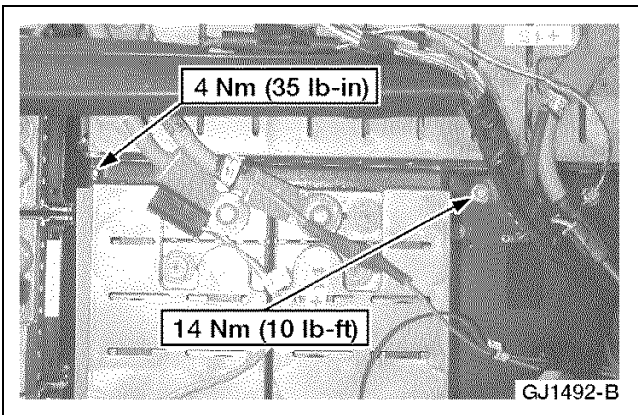
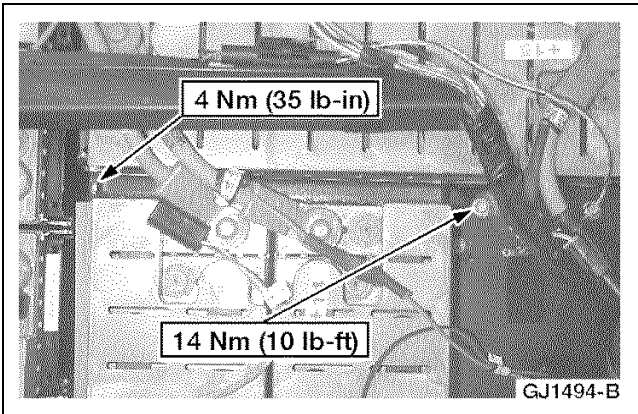
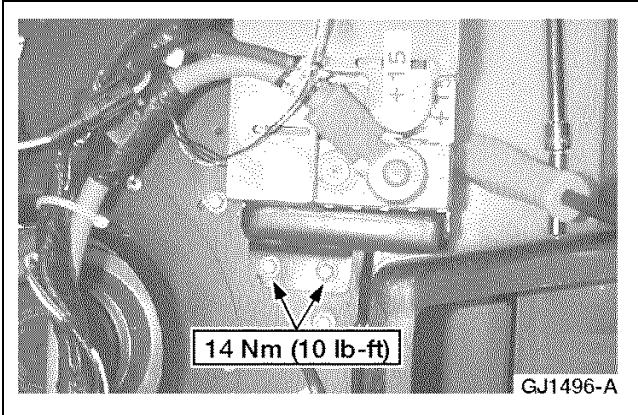



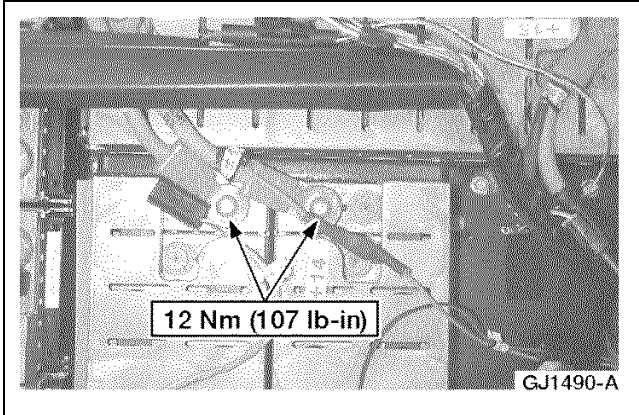

**REMOVAL AND INSTALLATION (Continued)**

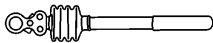
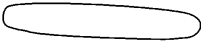

**Traction Battery Module —Modules 17, 18, 21**

**Special Tool(s)**

 <p>ST2097-A</p>	<p>Battery Post Torque Wrench 307-026</p>
 <p>ST2091-A</p>	<p>Battery Terminal Cap Opener 418-F215</p>
 <p>ST2345-A</p>	<p>Battery Handles 414-F001</p>

**Removal**

1. This procedure contains steps specific to the modules listed. Do not start with this procedure. Refer to [Traction Battery Module Replacement](#) to begin module replacement.

## REMOVAL AND INSTALLATION (Continued)

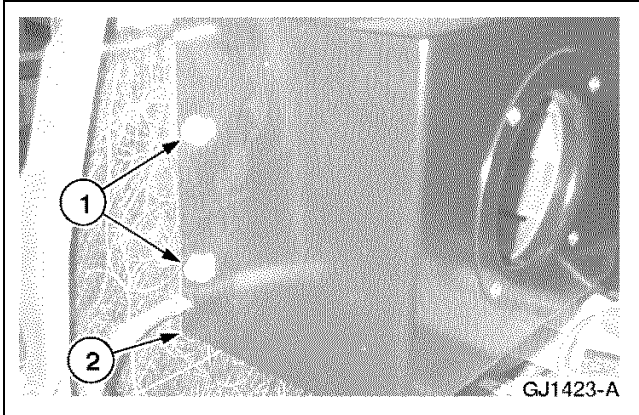

2. Remove the blower cover.
  - 1 Remove the four bolts (two each side).
  - 2 Remove the blower cover.

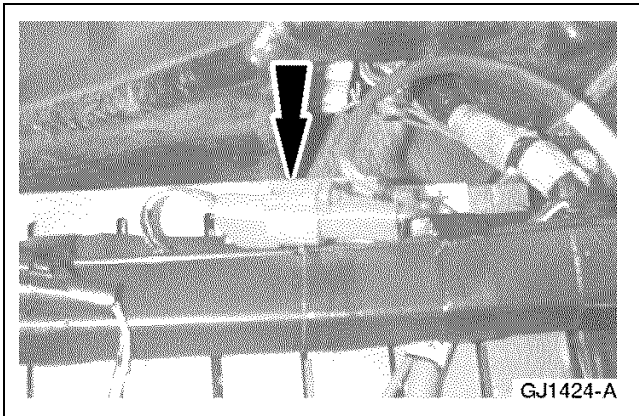

3. Disconnect the blower electrical connector.

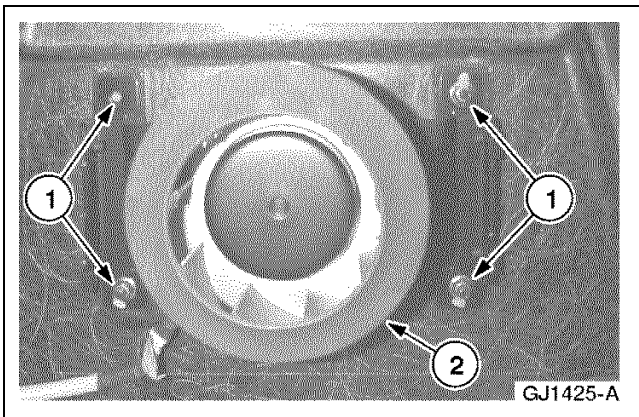

4. Remove the flow through blower.
  - 1 Remove the nuts.
  - 2 Remove the blower.

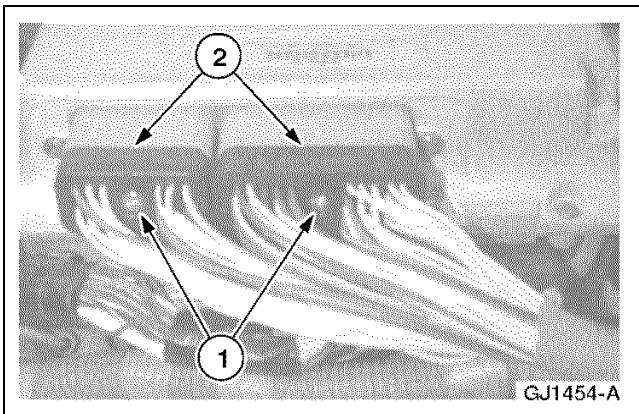

5. Disconnect the high-voltage connector.
  - 1 Loosen the bolts.
  - 2 Disconnect the connectors.

## REMOVAL AND INSTALLATION (Continued)

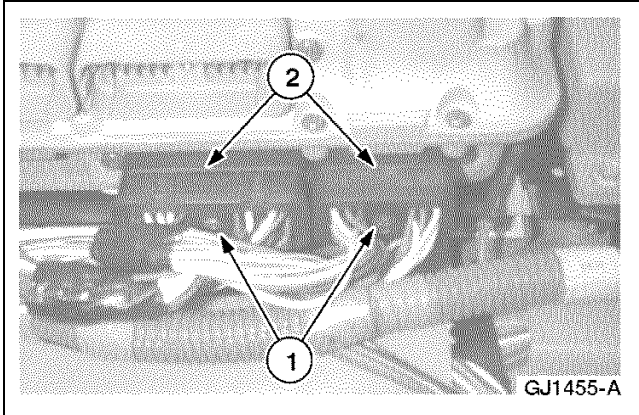

6. Disconnect the low-voltage connector.
  - 1 Loosen the bolts.
  - 2 Disconnect the connectors.

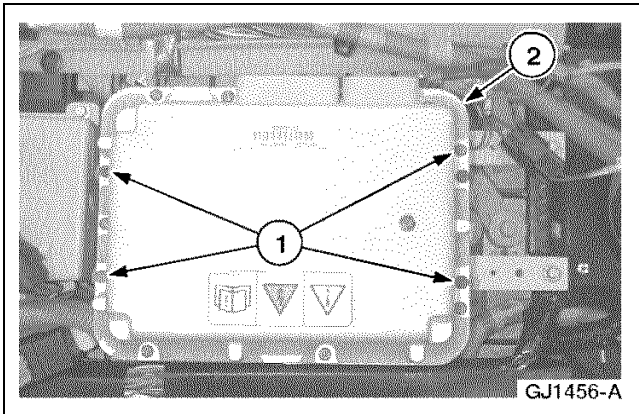

7. Remove the battery control module (BCM).
  - 1 Remove the bolts.
  - 2 Remove the BCM.

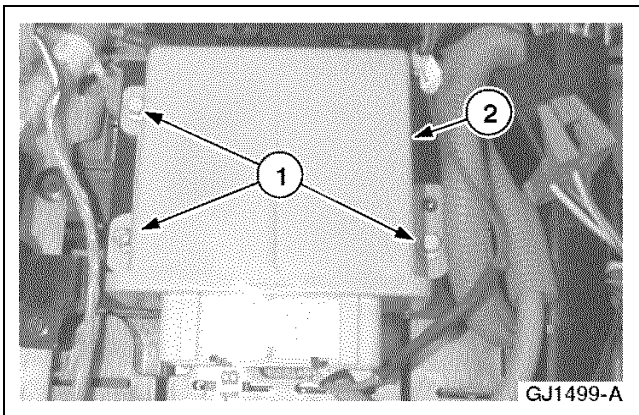

8. Position the IOM.
  - 1 Remove the bolts.
  - 2 Position the IOM aside.

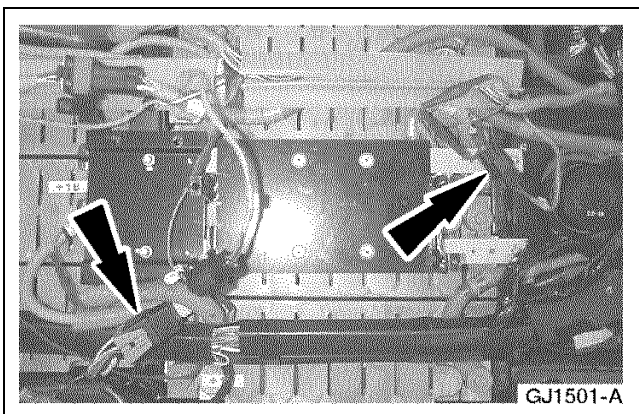

9. Unclip the sense lead and relay from the BCM/IOM bracket.

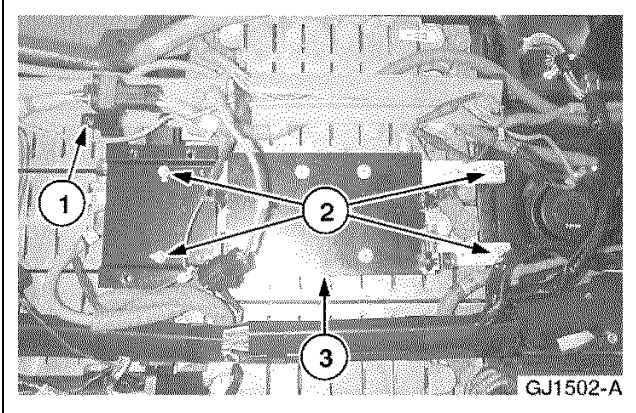
**REMOVAL AND INSTALLATION (Continued)**

10. Remove the BCM/IOM bracket.
  - 1 Remove the 4-pin auxiliary connector bracket bolt.
  - 2 Remove the bracket mounting bolts.
  - 3 Remove the bracket.

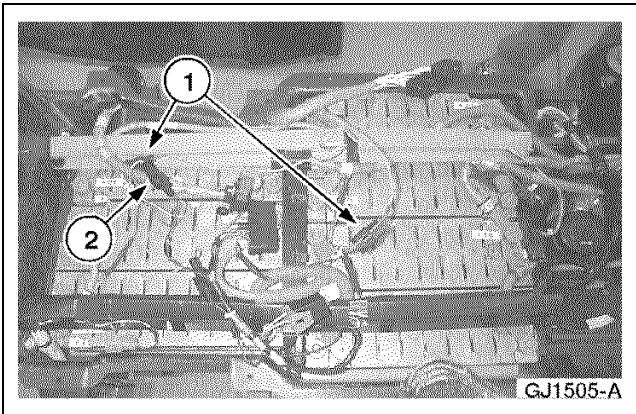

11. Disconnect the harness connectors.
  - 1 Disconnect the sense lead connectors.
  - 2 Unclip and disconnect the thermistor.

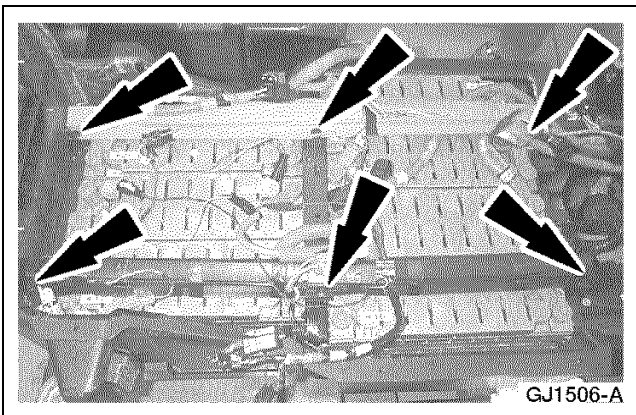

12. Remove the low and high-voltage harness push pins and fold the harnesses back over the rear of the traction battery.

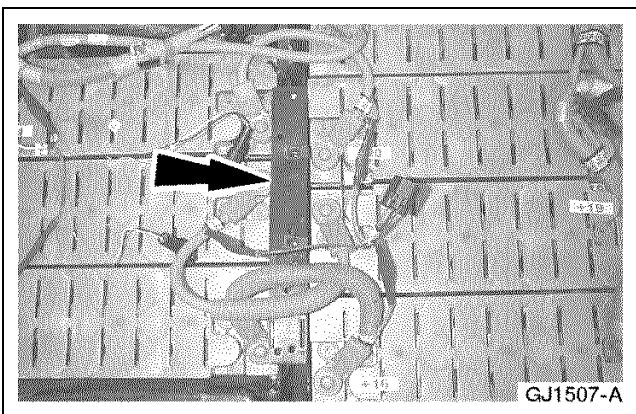

13. Unclip the battery hold down tie bar cover.

## REMOVAL AND INSTALLATION (Continued)

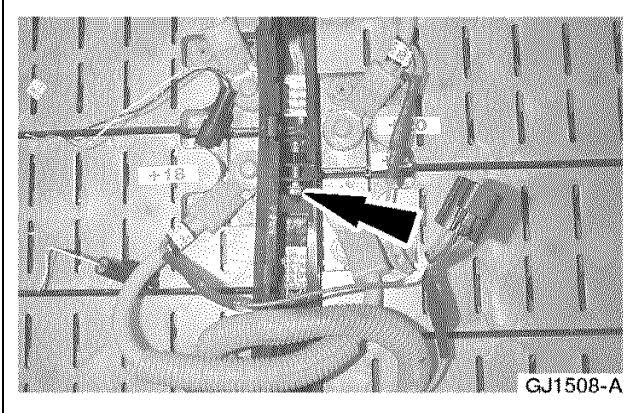

14. Remove the battery hold down strap bolt and pull the straps back off the battery hold down tie bar.

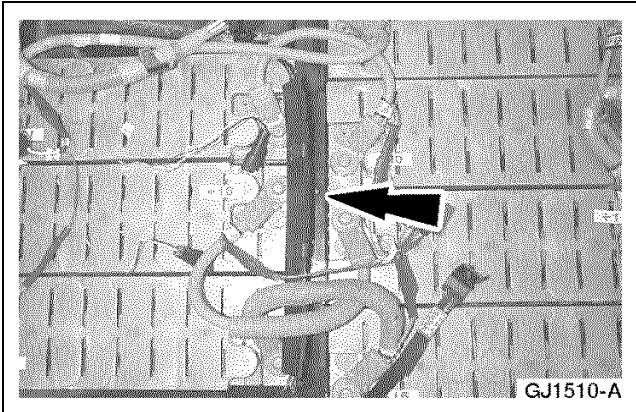

15. Remove the battery hold down tie bar.

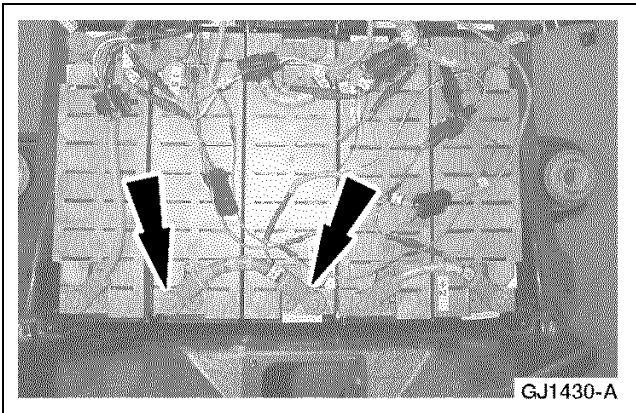

16. **NOTE:** If removing module 18, disconnect the two thermistor electrical connectors.

Disconnect the necessary module.

- Disconnect the HVJ cables and discard the nuts.

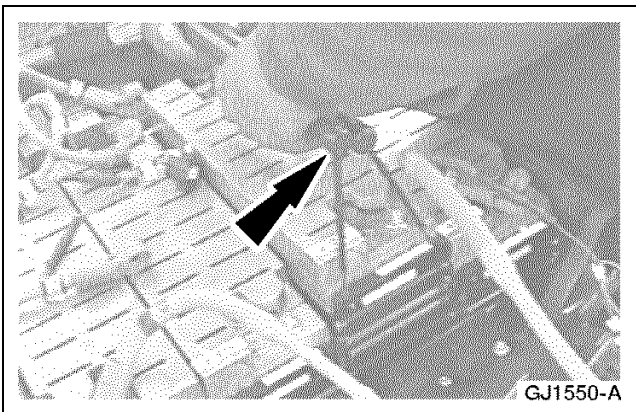

17. Using the special tool, remove the module.

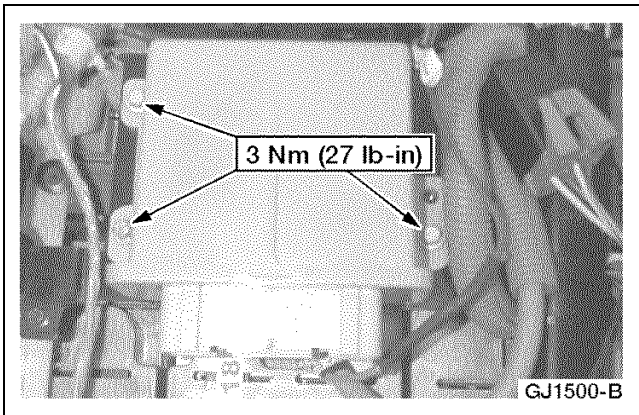
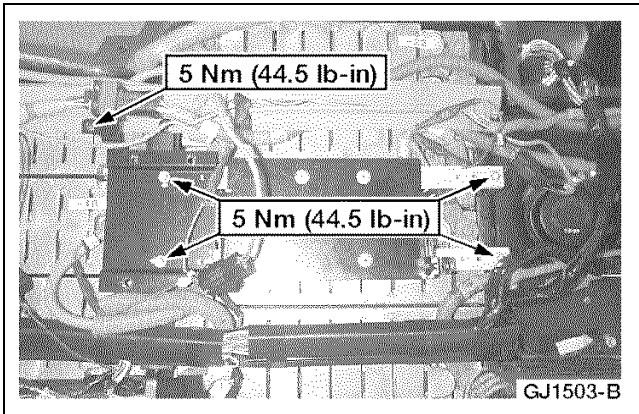
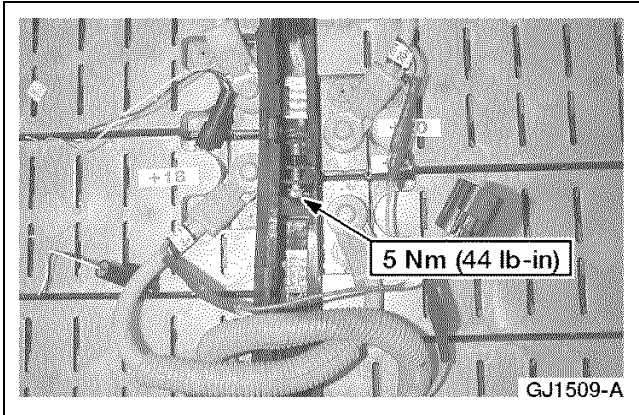
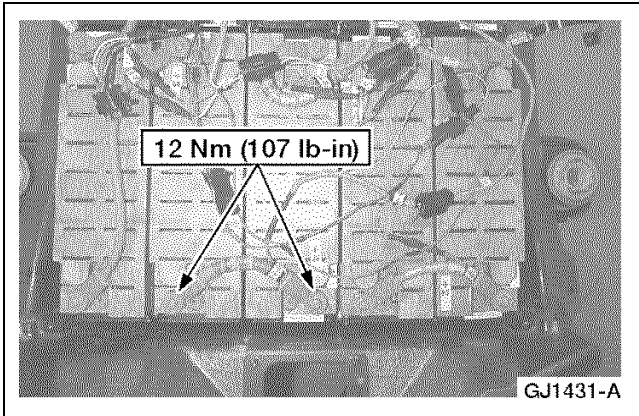
**REMOVAL AND INSTALLATION (Continued)****Installation**

1. **NOTE:** The arrow on the battery hold down tie bars must be pointed towards the front of the traction battery.

To install, reverse the removal procedure.

- Fill the high-voltage jumper connectors with Nyogel after final tightening of the nuts.

**REMOVAL AND INSTALLATION (Continued)**

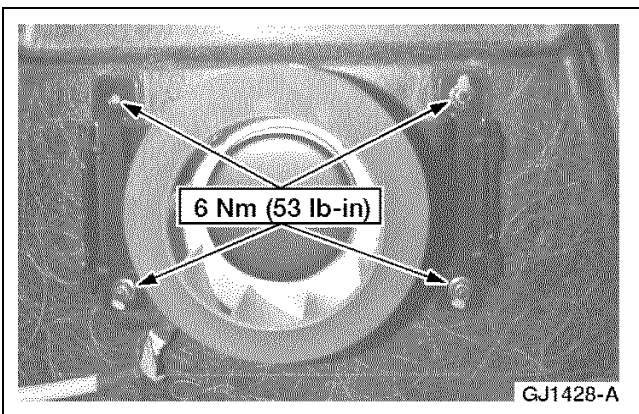
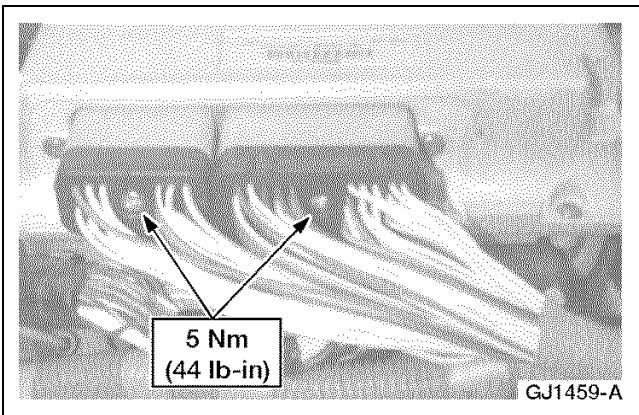
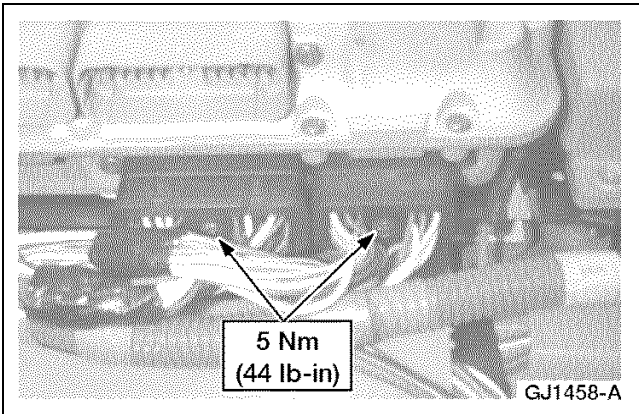
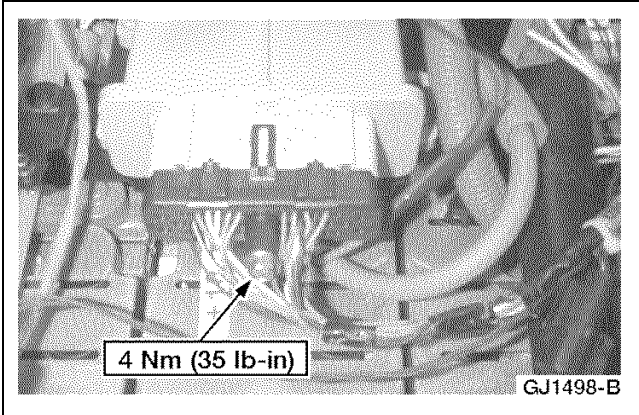

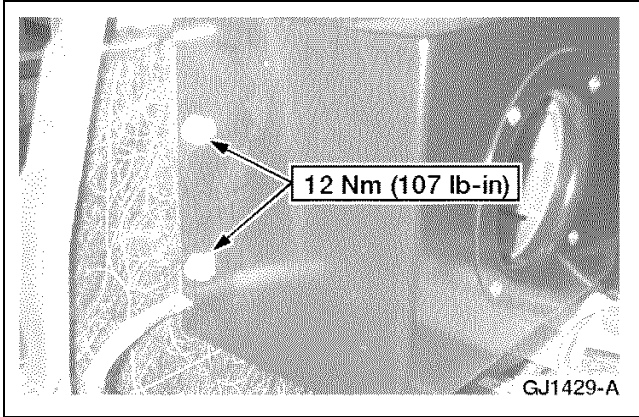

**REMOVAL AND INSTALLATION (Continued)**

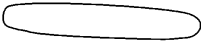

**Traction Battery Module —Modules 16, 19, 20, 22**

**Special Tool(s)**

 <p>ST2097-A</p>	<p>Battery Post Torque Wrench 307-026</p>
 <p>ST2091-A</p>	<p>Battery Terminal Cap Opener 418-F215</p>
 <p>ST2345-A</p>	<p>Battery Handles 414-F001</p>



## REMOVAL AND INSTALLATION (Continued)

### Removal

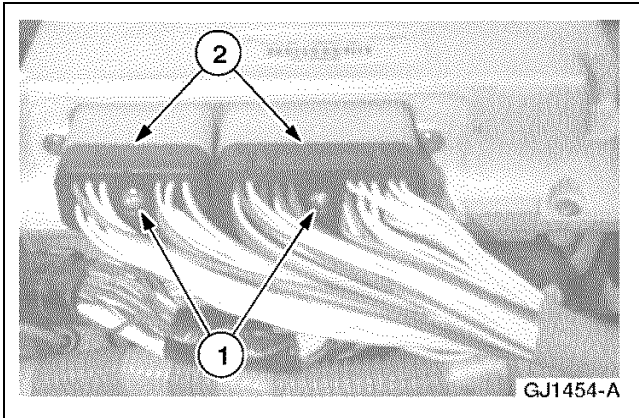

1. Disconnect the high-voltage connector.
  - 1 Loosen the bolts.
  - 2 Disconnect the connectors.

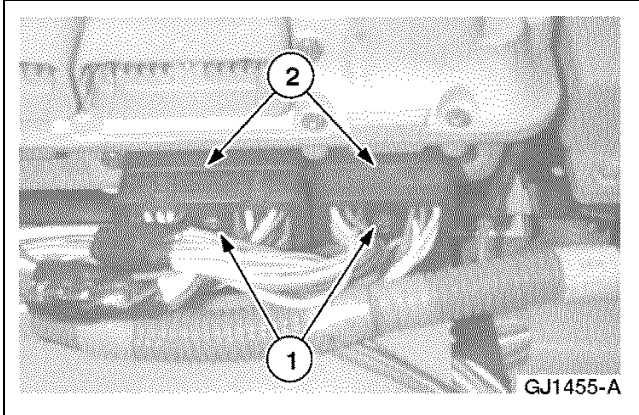

2. Disconnect the low-voltage connector.
  - 1 Loosen the bolts.
  - 2 Disconnect the connectors.

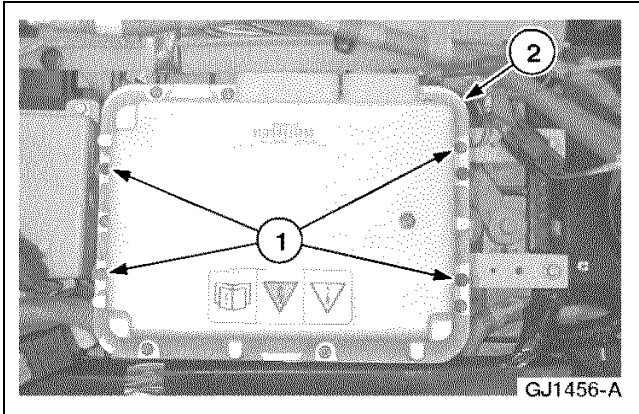

3. Remove the battery control module (BCM).
  - 1 Remove the bolts.
  - 2 Remove the BCM.

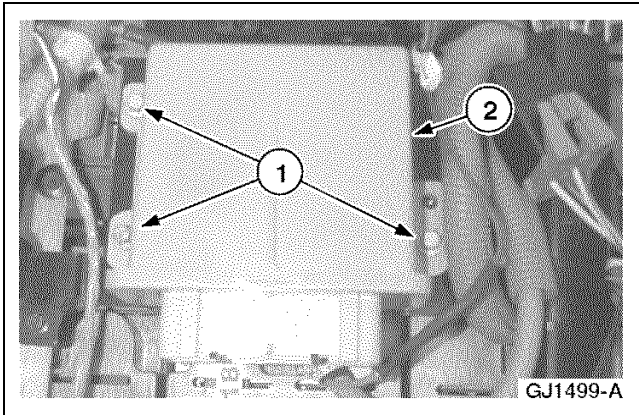

4. Position the IOM.
  - 1 Remove the bolts.
  - 2 Position the IOM aside.

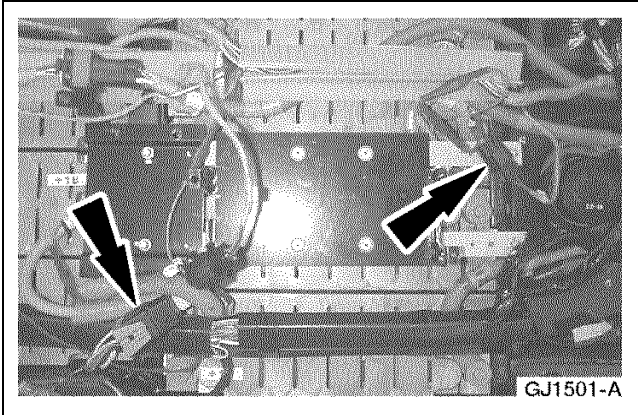
**REMOVAL AND INSTALLATION (Continued)**

5. Unclip the sense lead and relay from the BCM/IOM bracket.

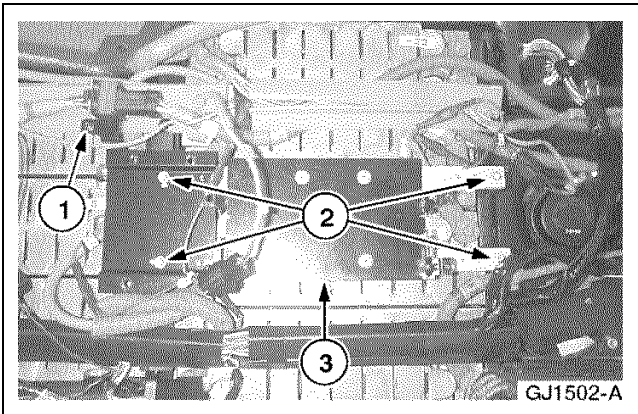

6. Remove the BCM/IOM bracket.
  - 1 Remove the 4-pin auxiliary connector bracket bolt.
  - 2 Remove the bracket mounting bolts.
  - 3 Remove the bracket.

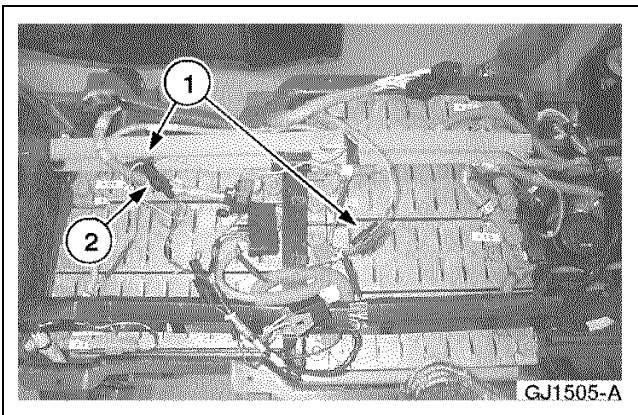

7. Disconnect the harness connectors.
  - 1 Disconnect the sense lead connectors.
  - 2 Unclip and disconnect the thermistor.

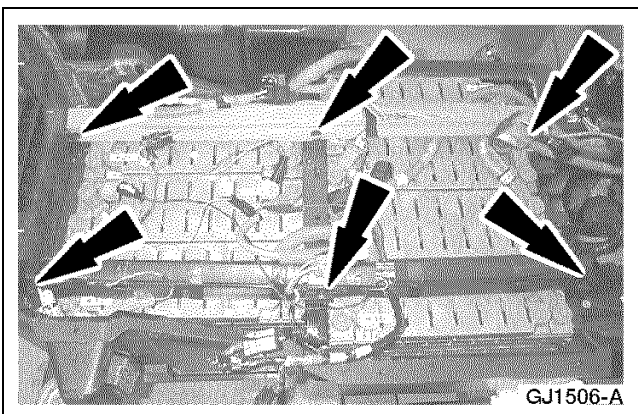

8. Remove the low and high-voltage harness push pins and fold the harnesses back over the rear of the traction battery.

## REMOVAL AND INSTALLATION (Continued)

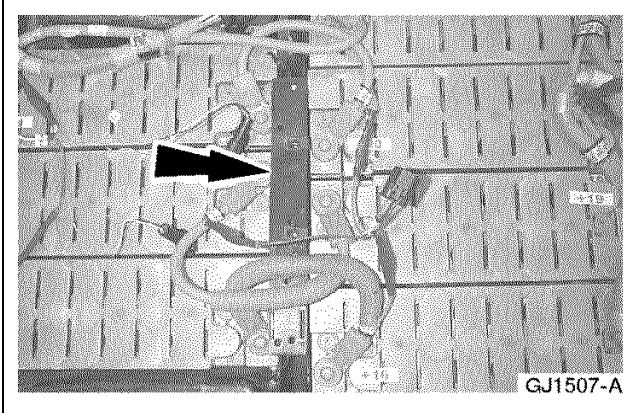

9. Unclip the battery hold down tie bar cover.

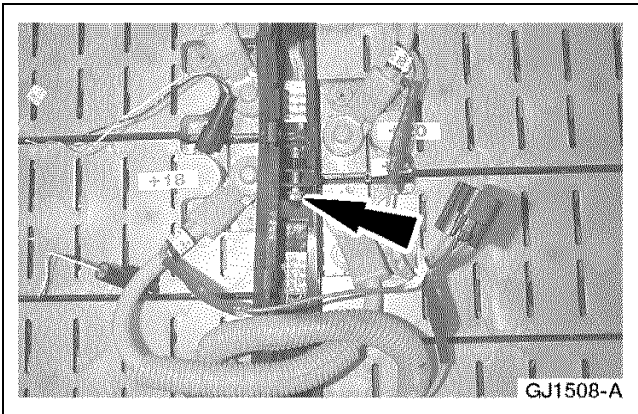

10. Remove the battery hold down strap bolt and pull the straps back off the battery hold down tie bar.

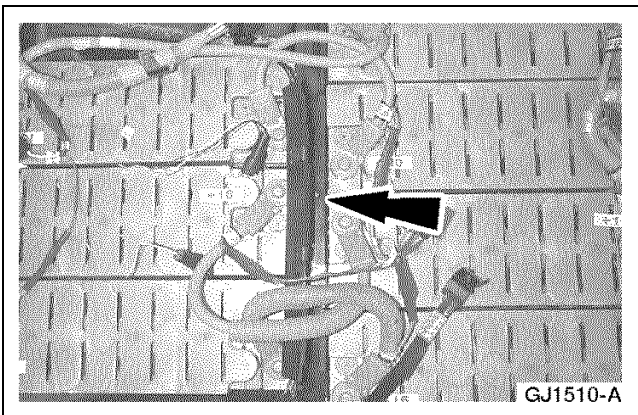

11. Remove the battery hold down tie bar.

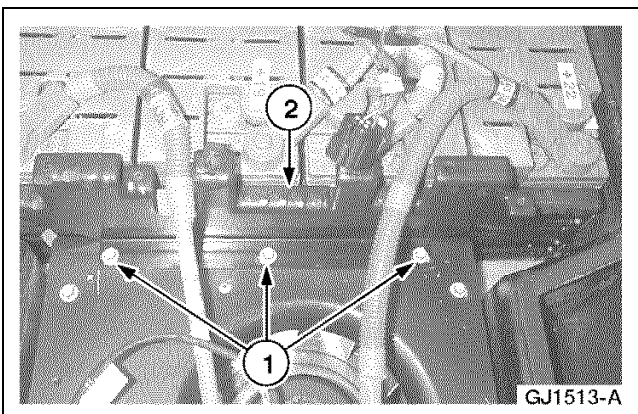

12. Remove the module hold down.
- 1 Remove the bolts.
  - 2 Remove the hold down.

## REMOVAL AND INSTALLATION (Continued)

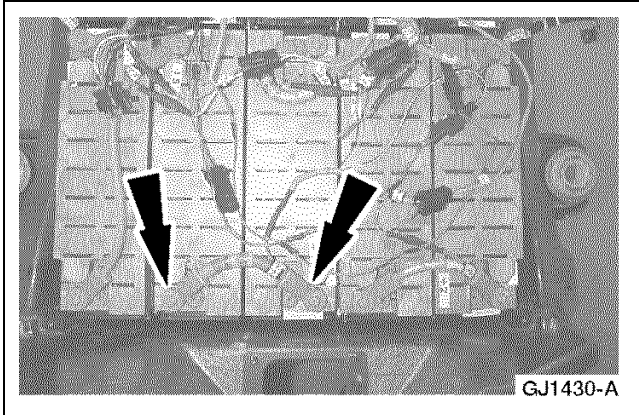

13. Disconnect the necessary module.
  - Disconnect the HVJ cables and discard the nuts.

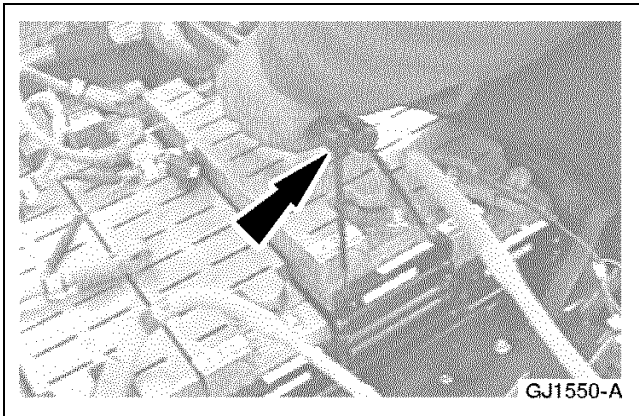

14. Using the special tool, remove the module.

## Installation

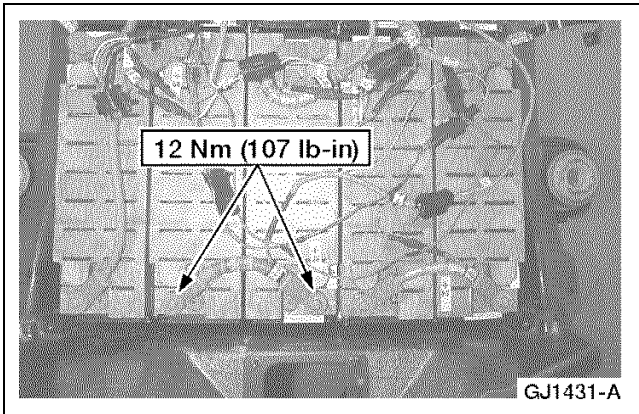

1. **NOTE:** The arrow on the battery hold down tie bars must be pointed towards the front of the traction battery.

To install, reverse the removal procedure.

- Fill the high-voltage jumper connectors with Nyogel after final tightening of the nuts.

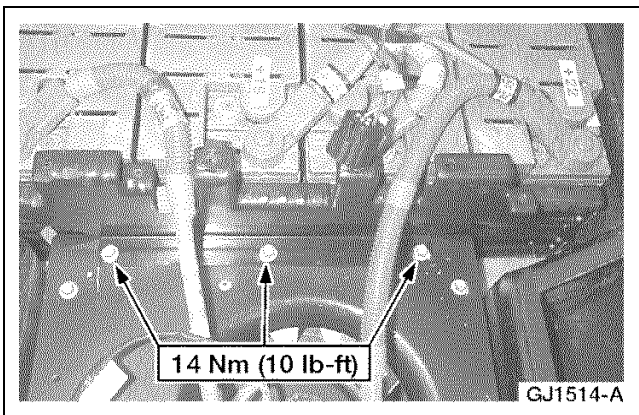

**REMOVAL AND INSTALLATION (Continued)**

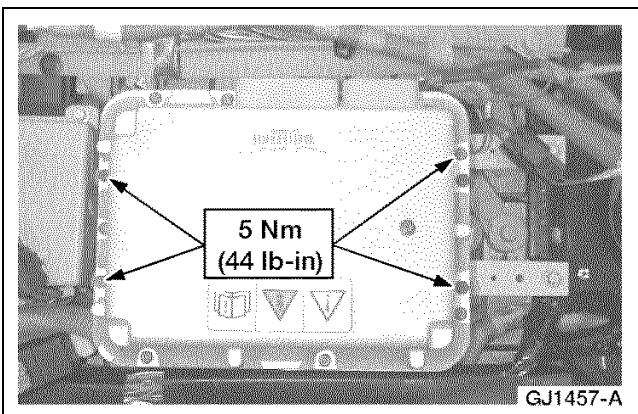
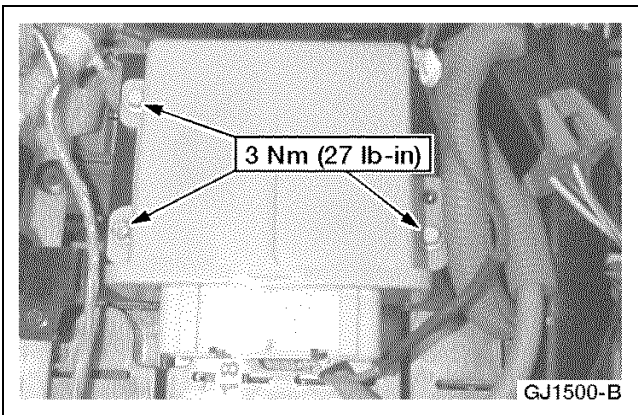
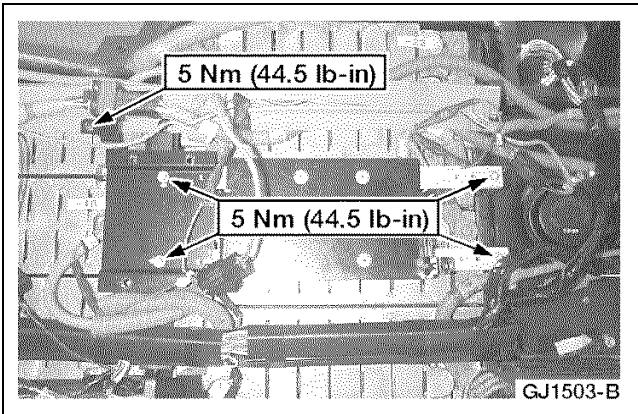
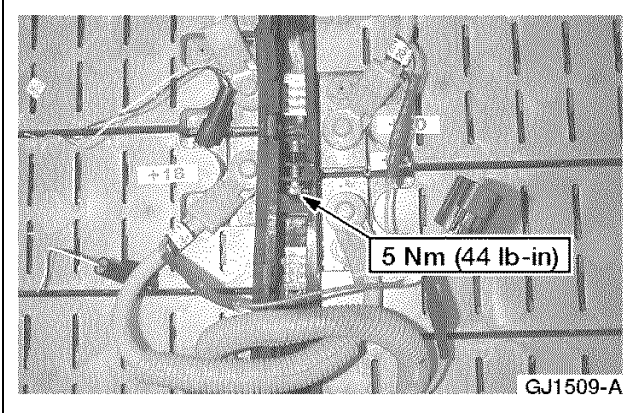

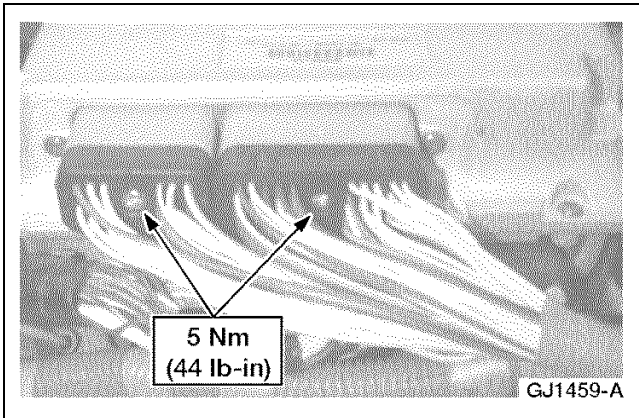
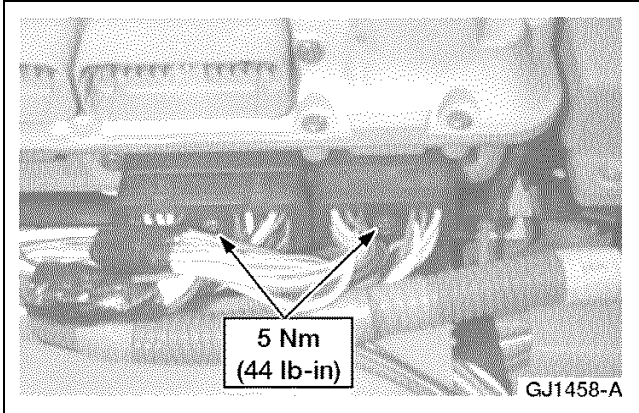
**REMOVAL AND INSTALLATION (Continued)****Independent Observer Module —(IOM)****Removal**

1. Remove the traction battery. Refer to [Traction Battery](#).
2. Remove the traction battery cover.
  - 1 Remove the 22 bolts.
  - 2 Remove the cover.

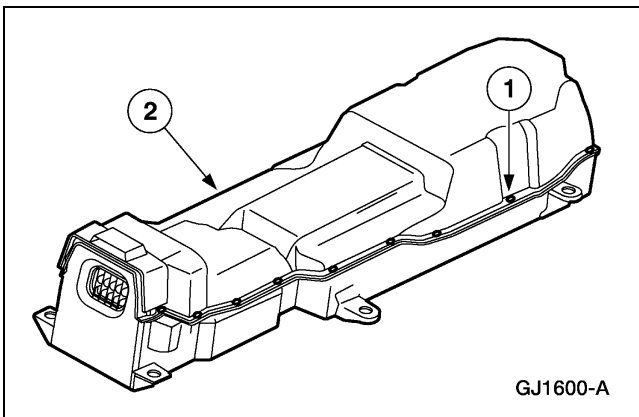

**REMOVAL AND INSTALLATION (Continued)**

3.  **WARNING:** The nominal voltage of the traction battery is 300 volts. The buffer zone must be set up and insulated rubber gloves and a face shield must be worn. Failure to follow these precautions may result in severe personal injury or death.

Observe the EV-specific precautions. Refer to [Section 100-00](#).

- 1 Set up the buffer zone.
- 2 Test and wear the insulated rubber gloves.
- 3 Wear the face shield.

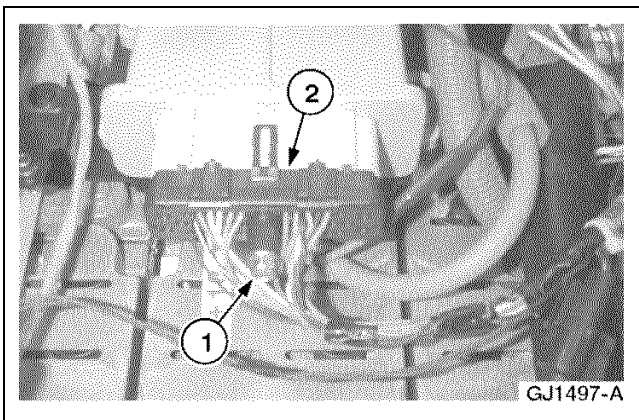

4. Disconnect the independent observer module (IOM) electrical connector.
- 1 Loosen the bolt.
  - 2 Unclip the connector.

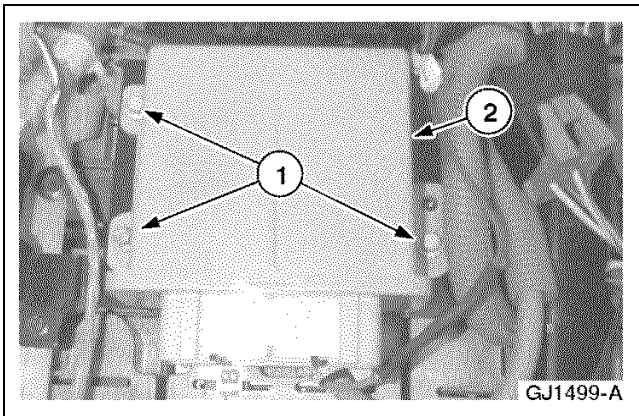

5. Remove the IOM.
- 1 Remove the bolts.
  - 2 Remove the IOM.

## REMOVAL AND INSTALLATION (Continued)

### Installation

1. To install, reverse the removal procedure.

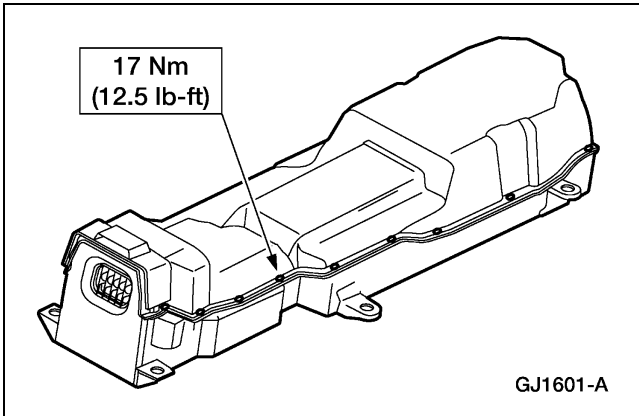
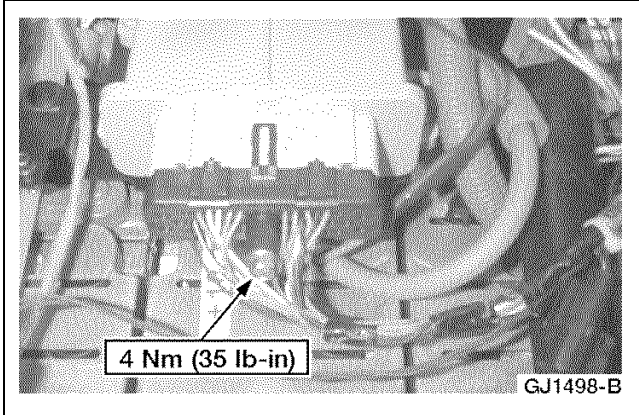
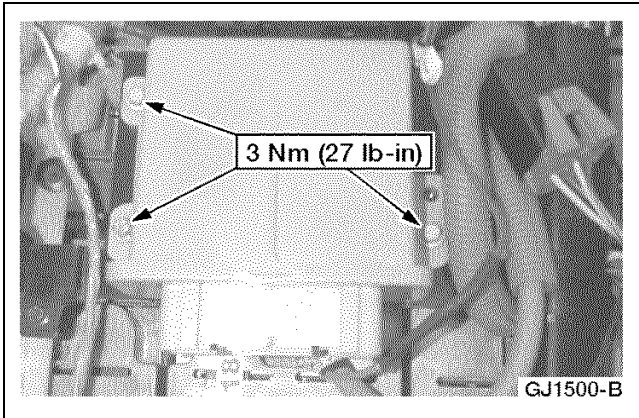



## DISASSEMBLY AND ASSEMBLY

### Traction Battery

#### Special Tool(s)

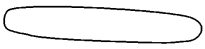
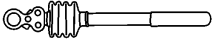
 <p>ST2091-A</p>	Battery Terminal Cap Opener 418-F215
 <p>ST2097-A</p>	Battery Post Torque Wrench 307-026

**DISASSEMBLY AND ASSEMBLY (Continued)**

**Traction Battery**

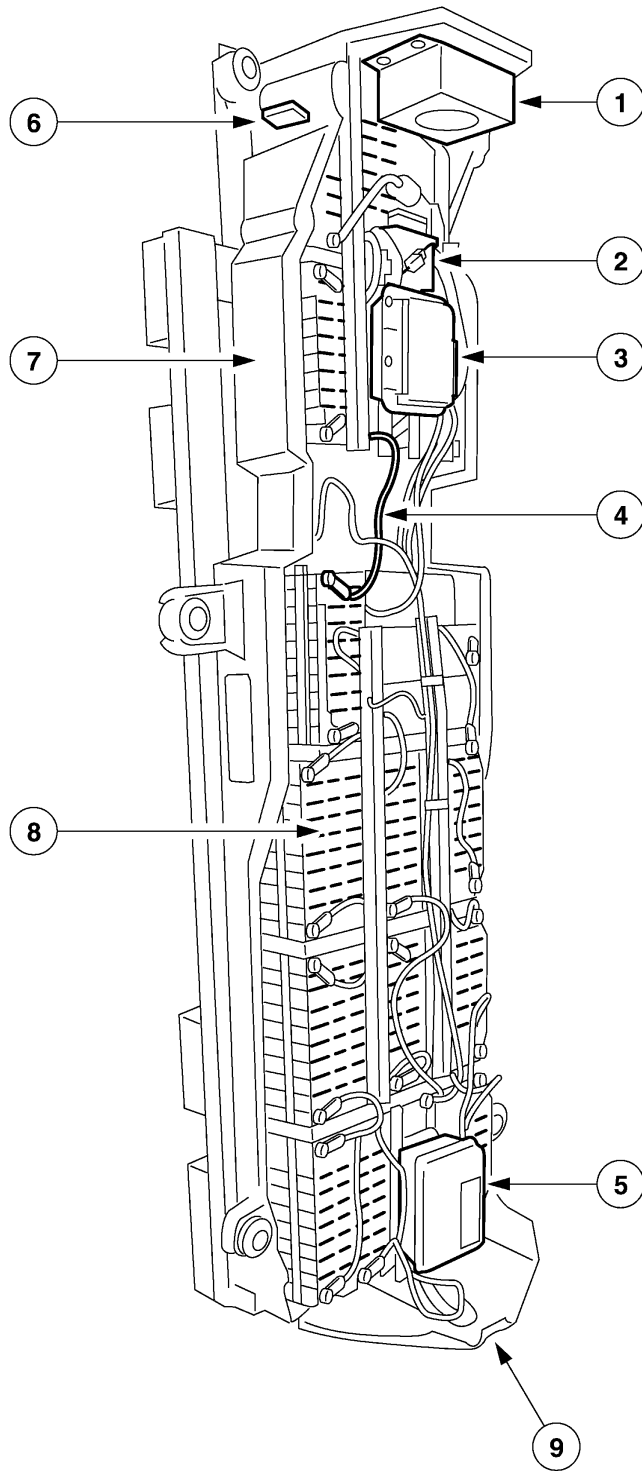

GJ1587-A

**DISASSEMBLY AND ASSEMBLY (Continued)**

Item	Description
1	Flow Through Blower Housing
2	Independent Observer Module (IOM)
3	Battery Control Module (BCM)
4	Recirculating Blower Assembly
5	Contacting Box Assembly (CBA)

(Continued)

Item	Description
6	76 Pin Connector
7	Battery Tray
8	Battery Modules
9	Two-Pin High Voltage Connector

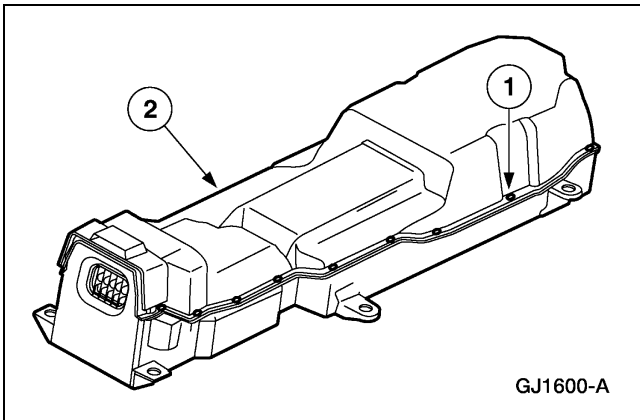

**Disassembly**

1. Remove the traction battery. Refer to [Traction Battery](#).

2. Remove the traction battery cover.

- 1 Remove the 22 bolts.
- 2 Remove the cover.

3. **⚠ WARNING: The nominal voltage of the traction battery is 300 volts. The buffer zone must be set up and insulated rubber gloves and a face shield must be worn. Failure to follow these precautions may result in severe personal injury or death.**

Observe the EV-specific precautions. Refer to [Section 100-00](#).

- 1 Set up the buffer zone.
- 2 Test and wear the insulated rubber gloves.
- 3 Wear the face shield.

4. **⚠ CAUTION: Disconnect only one HVJ at a time.**

Disconnect the HVJs from the contactor box.

- Open the cap.
- Remove and discard the nut.

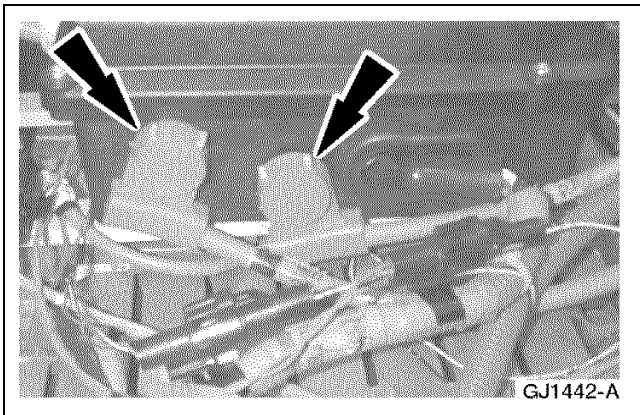

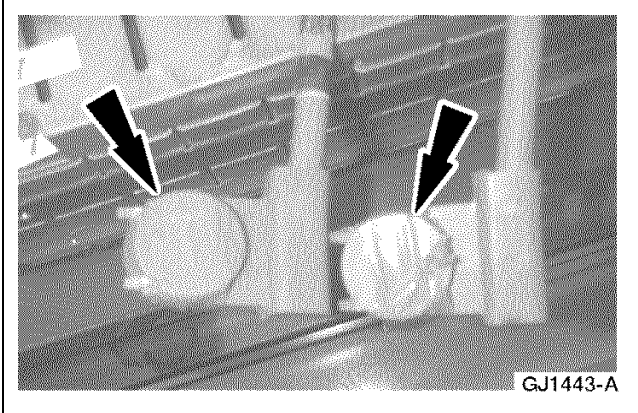
**DISASSEMBLY AND ASSEMBLY (Continued)**

5. Wrap the HVJ ends with orange electrical tape.

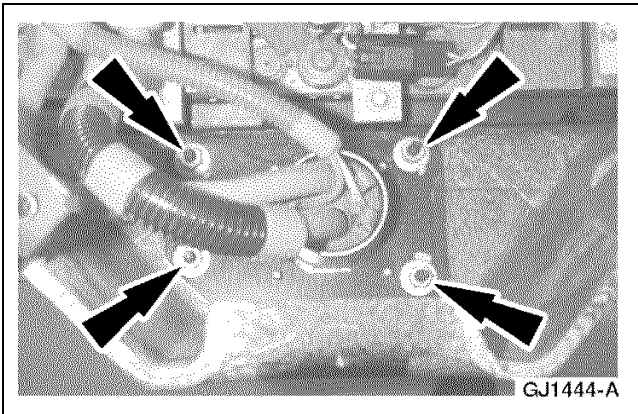

6. Remove the two-pin high-voltage connector nuts.

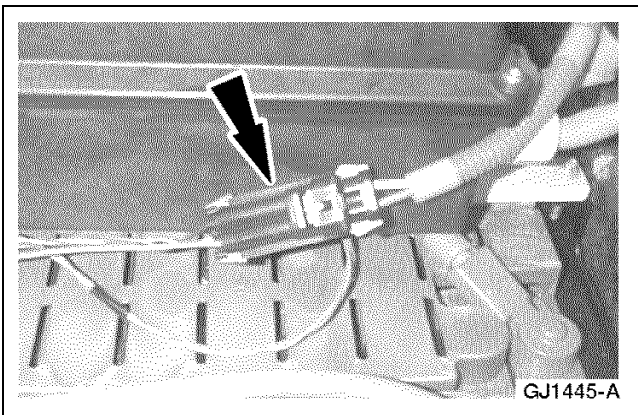

7. Disconnect the high-voltage interlock electrical connector.

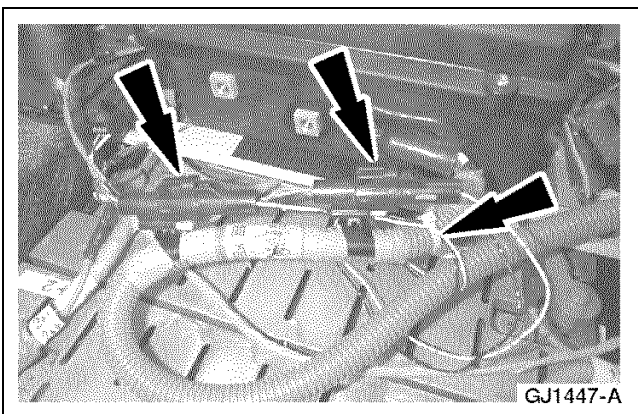

8. Unclip the thermistors from the high voltage harness and cut the zip tie.

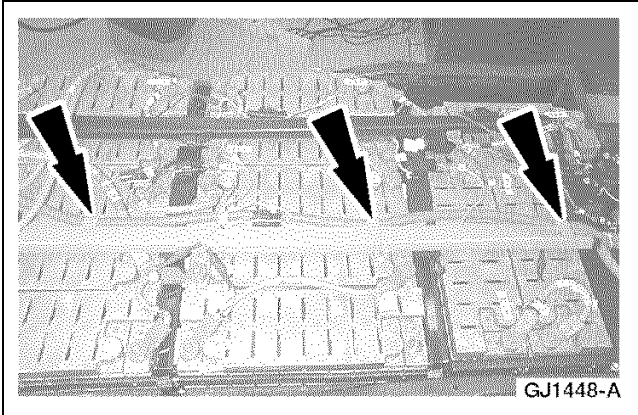
**DISASSEMBLY AND ASSEMBLY (Continued)**

9. Open the clips that secure the contactor box harness to the high voltage harness.

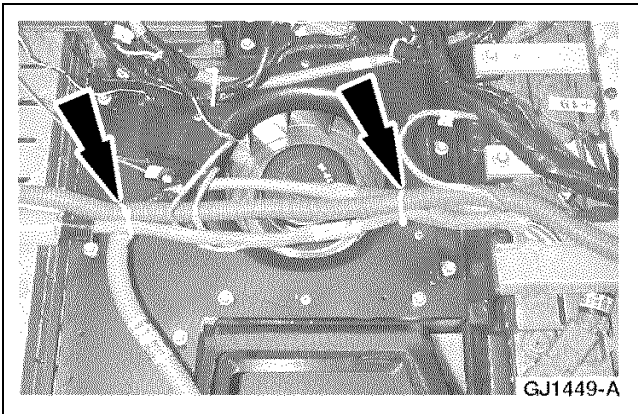

10. Cut the two zip ties securing the contactor box harness.

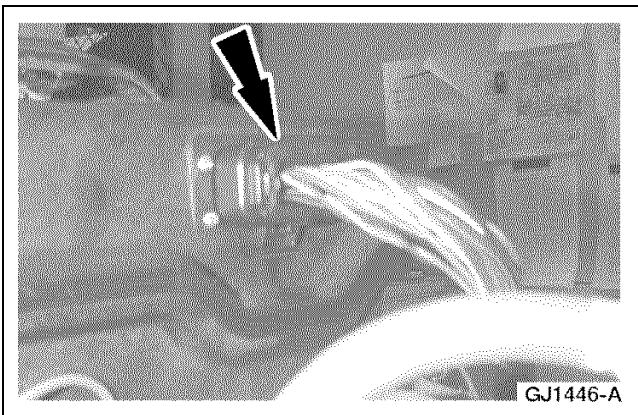

11. Disconnect the contactor box harness.

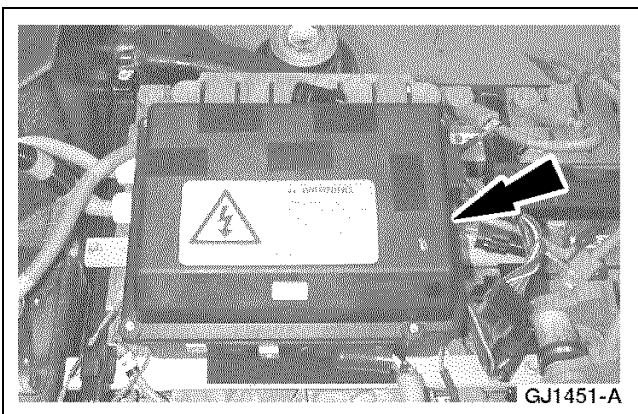

12. **NOTE:** The contactor box is held in place with strips of Velcro™.  
Remove the contactor box.

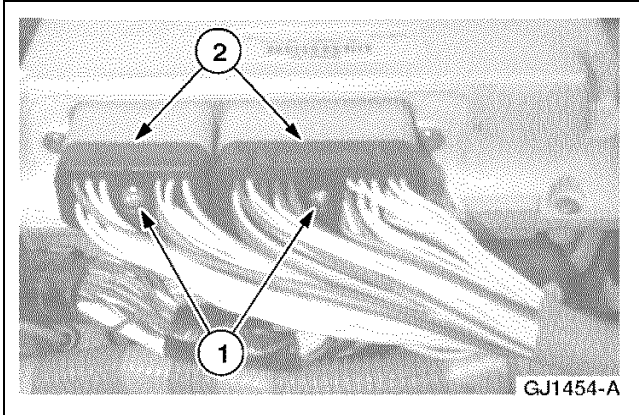
**DISASSEMBLY AND ASSEMBLY (Continued)**

13. Disconnect the high-voltage connector.

- 1 Loosen the bolts.
- 2 Disconnect the connectors.

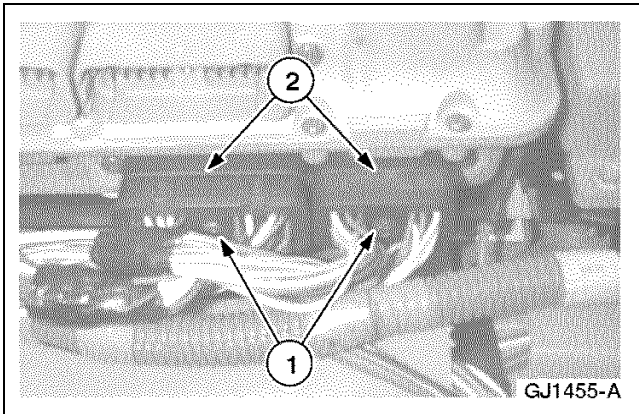

14. Disconnect the low voltage connector.

- 1 Loosen the bolts.
- 2 Disconnect the connectors.

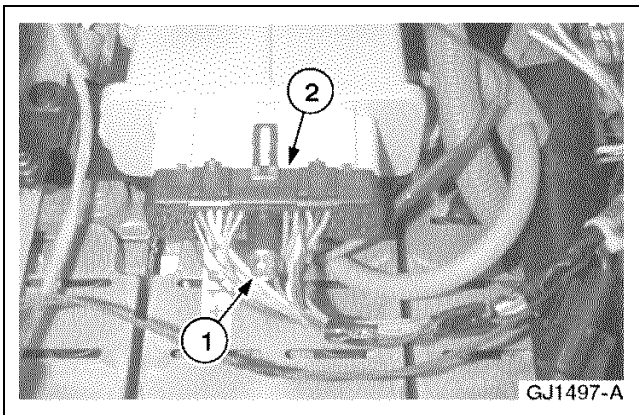

15. Disconnect the independent observer module (IOM) electrical connector.

- 1 Loosen the bolt.
- 2 Unclip the connector.

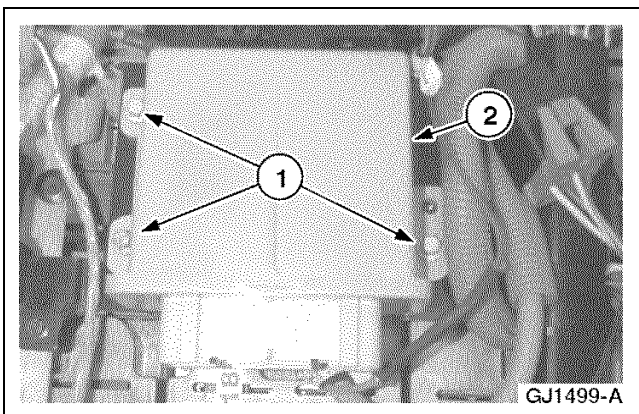

16. Remove the IOM.

- 1 Remove the bolts.
- 2 Remove the IOM.

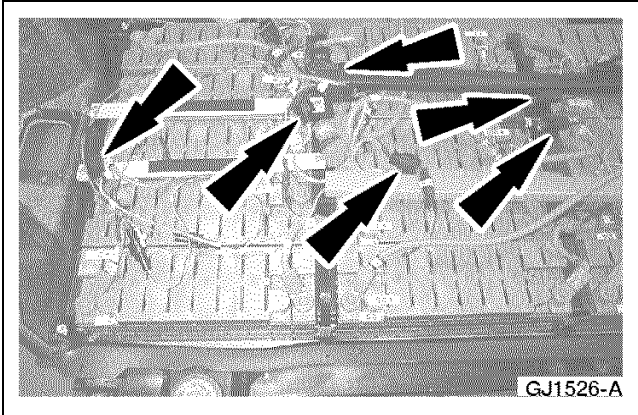
**DISASSEMBLY AND ASSEMBLY (Continued)**

17. Disconnect the sense leads.

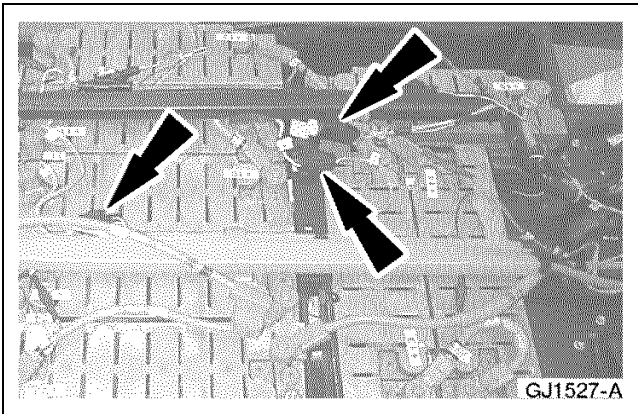

18. Disconnect the sense leads and unclip the relay.

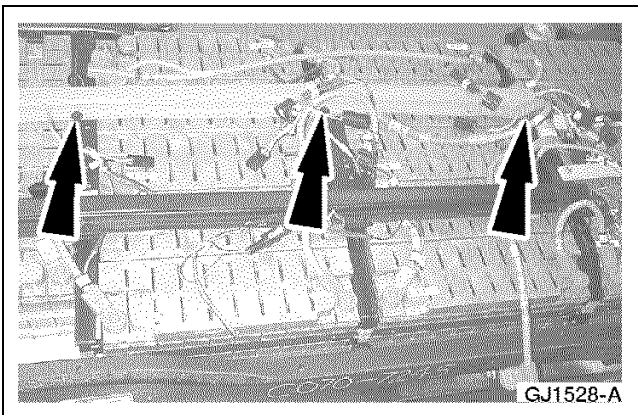

19. Remove the high-voltage harness push pins.

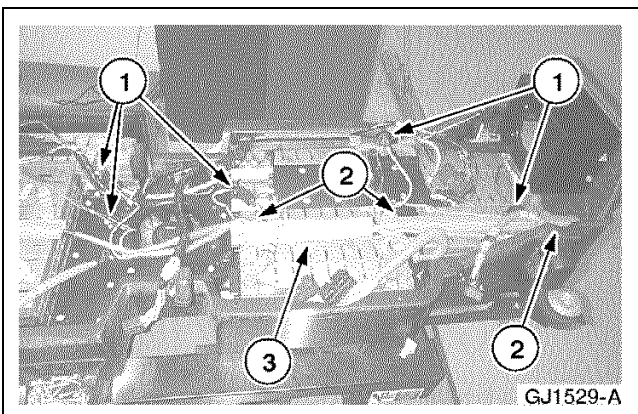

20. Remove the high voltage harness.

- 1 Disconnect the sense leads.
- 2 Remove the push pins.
- 3 Remove the harness.

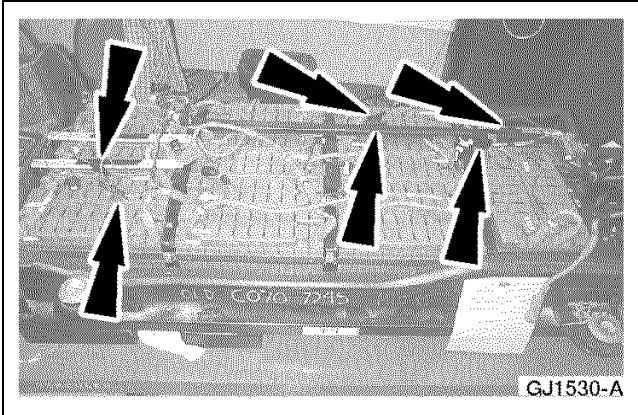
**DISASSEMBLY AND ASSEMBLY (Continued)**

21. Disconnect the thermistor electrical connectors and unclip the relay.

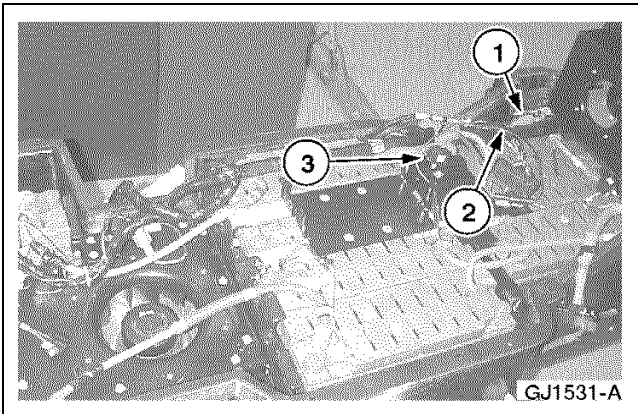

22. Disconnect the low-voltage harness.
- 1 Disconnect the blower electrical connectors.
  - 2 Disconnect the thermistor electrical connectors.
  - 3 Unclip the relay.

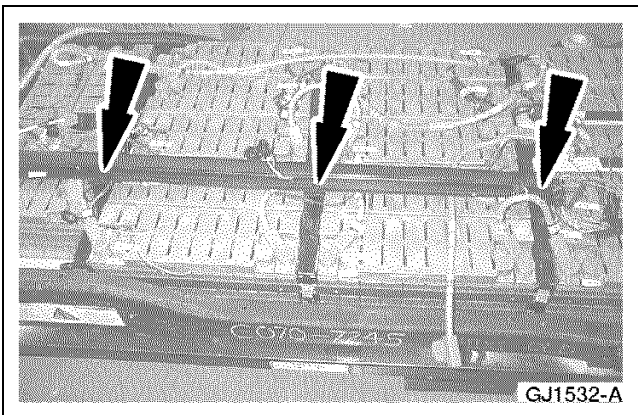

23. Remove the low-voltage harness push pins.

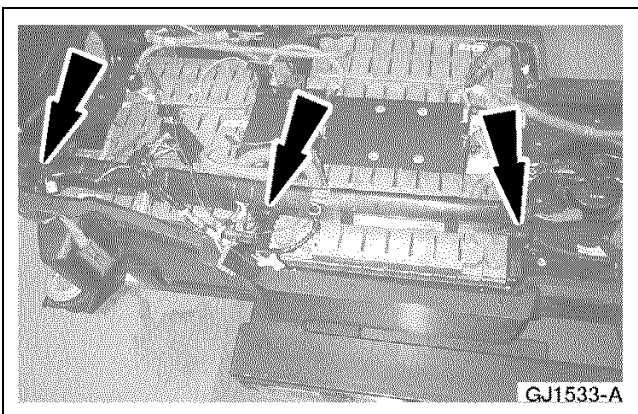

24. Remove the low-voltage harness push pins and remove the harness.

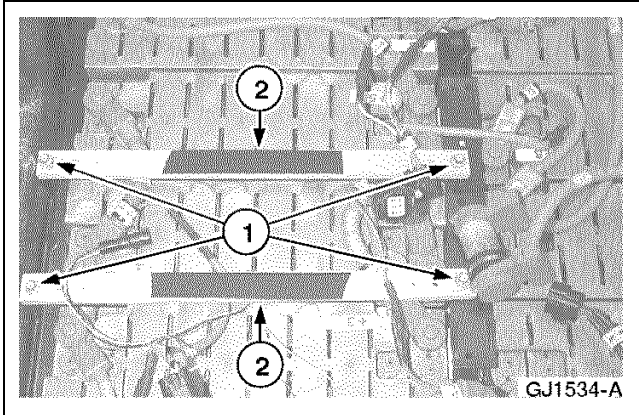

**DISASSEMBLY AND ASSEMBLY (Continued)**

25. Remove the composite bars.

- 1 Remove the bolts.
- 2 Remove the bars.

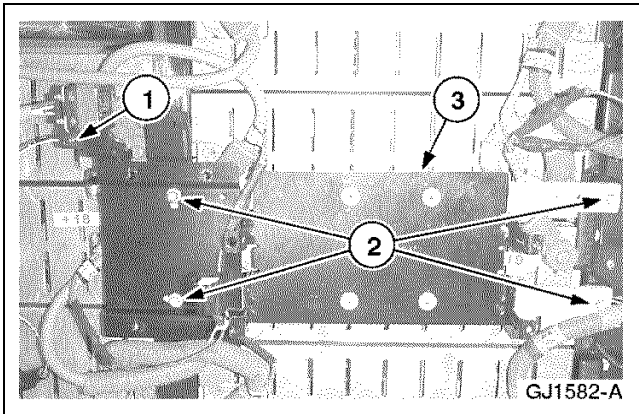

26. Remove the BCM/IOM mounting bracket.

- 1 Remove the 4-pin auxiliary mounting bolt.
- 2 Remove the bolts.
- 3 Remove the bracket.

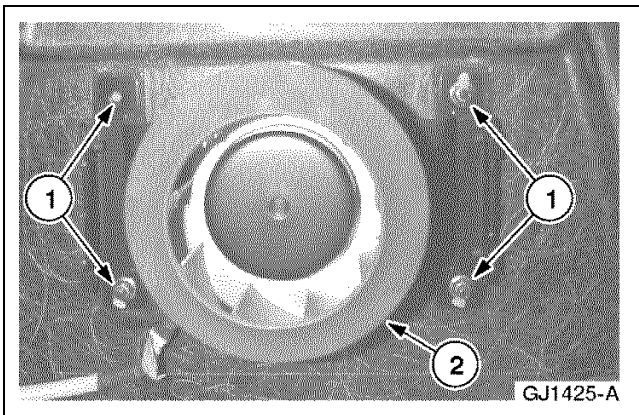

27. Remove the flow through blower.

- 1 Remove the nuts.
- 2 Remove the blower.

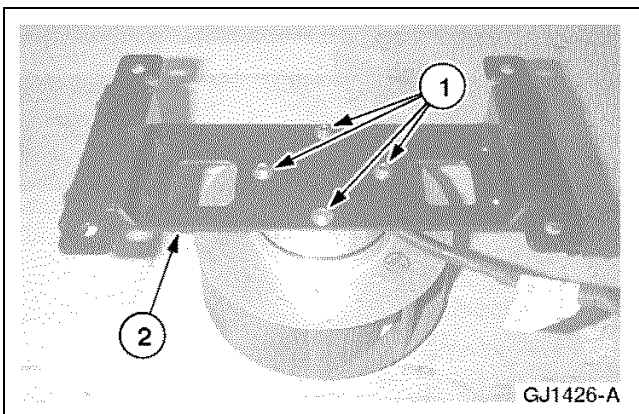

28. Remove the flow through blower bracket.

- 1 Remove the bolts.
- 2 Remove the bracket.

## DISASSEMBLY AND ASSEMBLY (Continued)

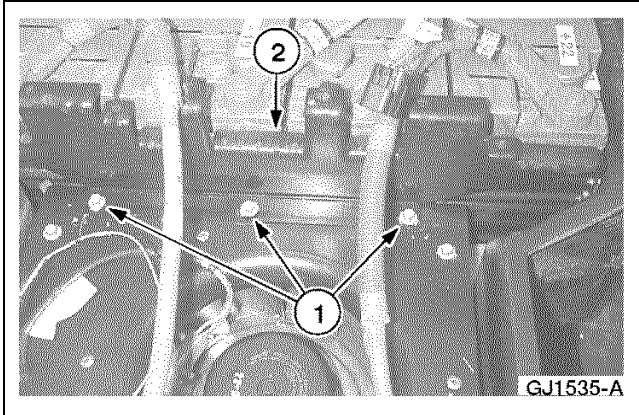

29. Remove the battery hold down.

- 1 Remove the bolts.
- 2 Remove the hold down.

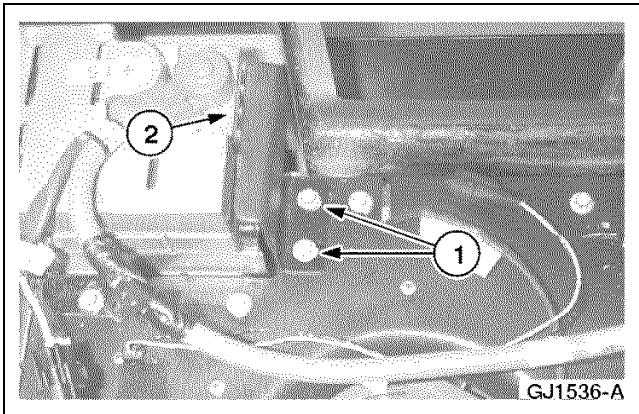

30. Remove the battery hold down.

- 1 Remove the bolts.
- 2 Remove the hold down.

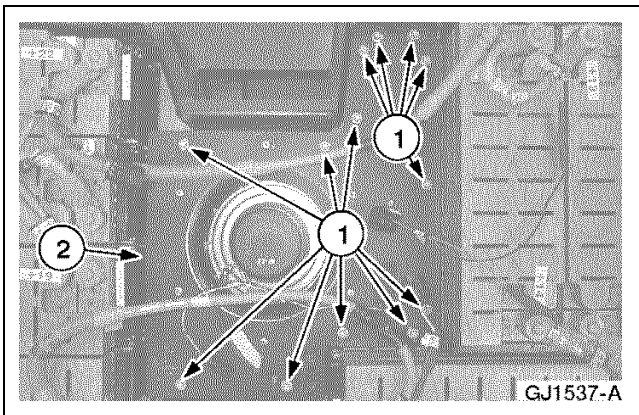

31. Remove the recirculating blower cover.

- 1 Remove the bolts.
- 2 Remove the cover.

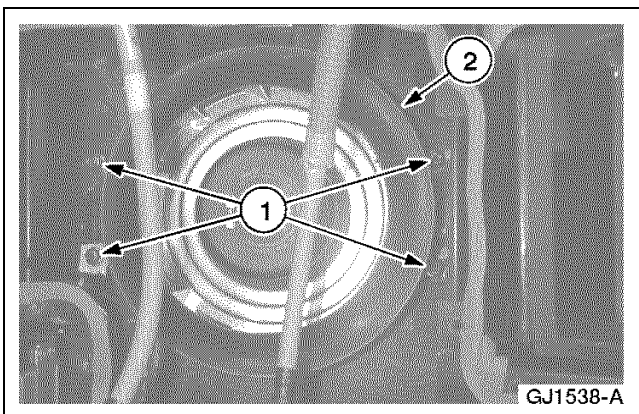

32. **NOTE:** The “P” clip that retains the blower harness is located on one of the drivers side blower mounting nuts. Note the location for installation.

Remove the recirculating blower.

- 1 Remove the nuts.
- 2 Remove the blower.

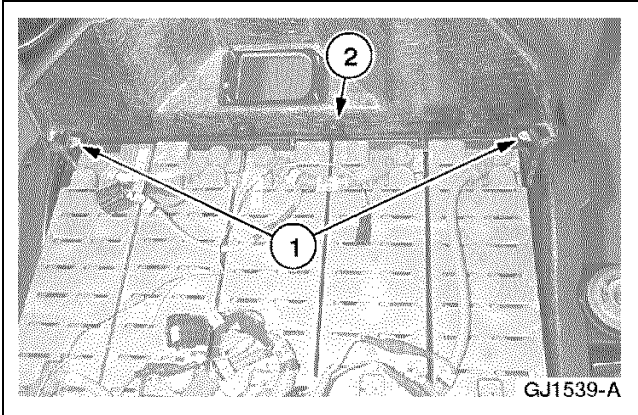
**DISASSEMBLY AND ASSEMBLY (Continued)**

33. Remove the rear battery hold down.

- 1 Remove the bolts.
- 2 Remove the hold down.

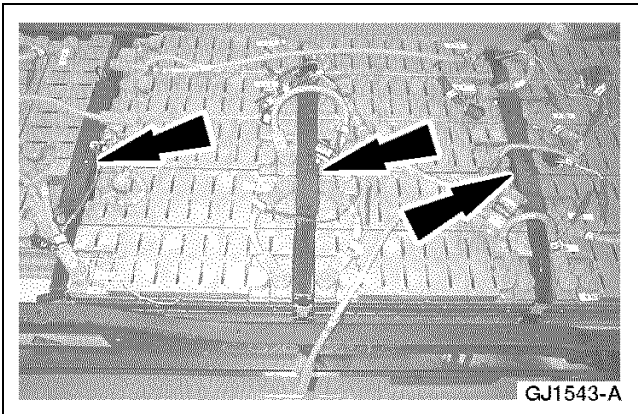

34. Unclip the battery hold down tie bar covers.

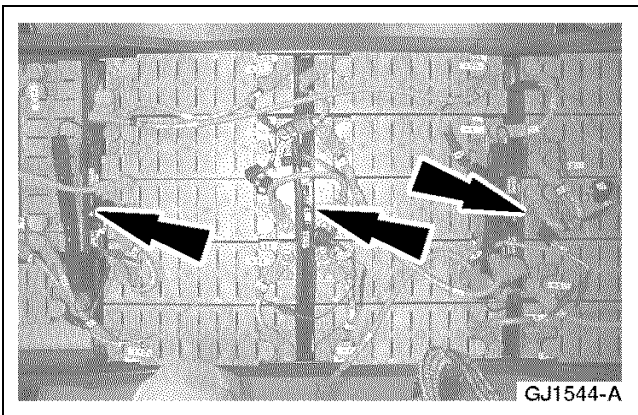

35. Remove the hold down strap bolts.

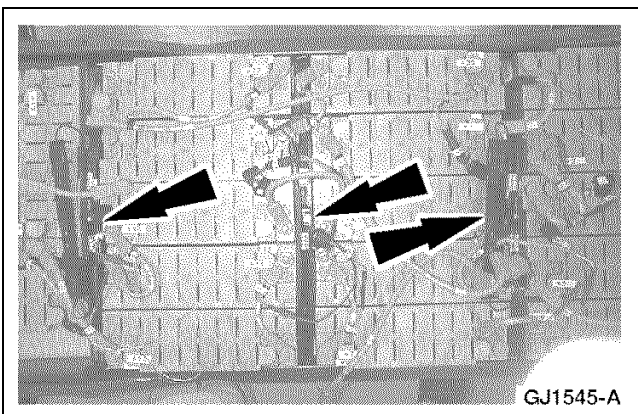

36. Remove the hold down tie bars.

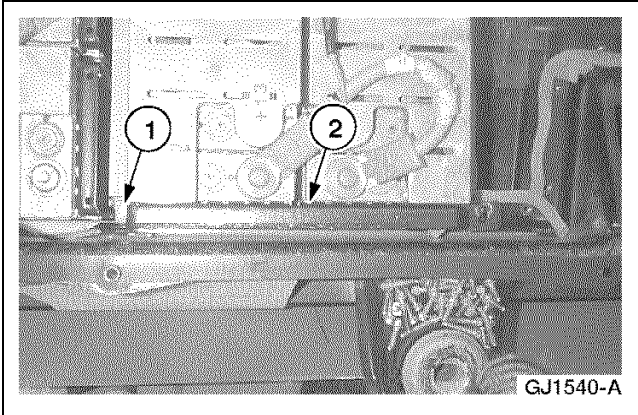
**DISASSEMBLY AND ASSEMBLY (Continued)**

37. Remove the battery hold down.

- 1 Remove the bolt.
- 2 Remove the hold down.

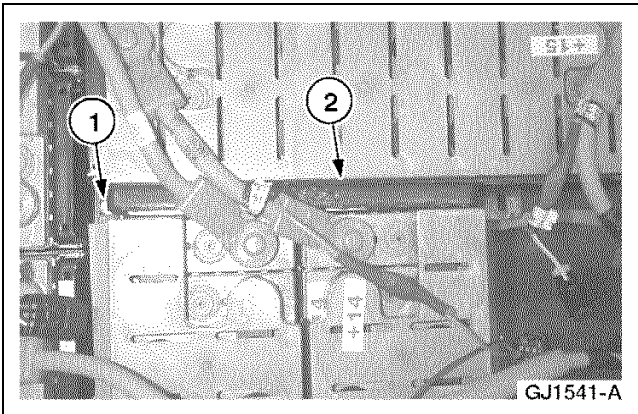

38. Remove the battery hold down.

- 1 Remove the bolt.
- 2 Remove the hold down.

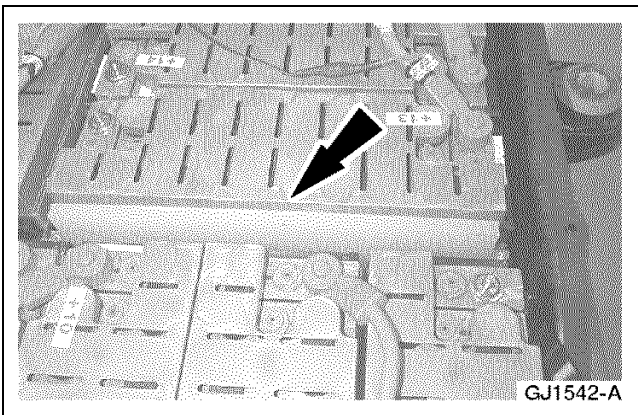

39. Remove the mid-wall.

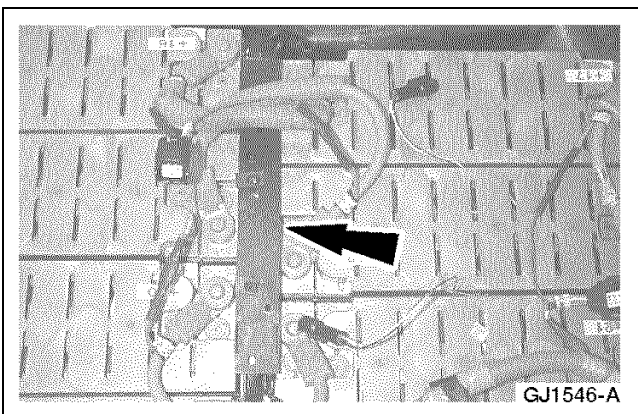

40. Unclip the front battery hold down tie bar cover.

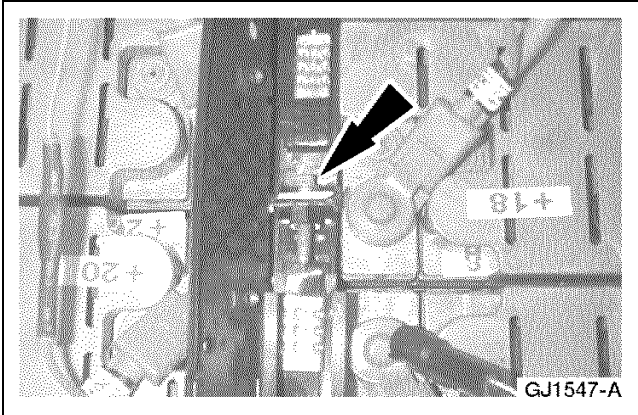
**DISASSEMBLY AND ASSEMBLY (Continued)**

41. Remove the hold down strap bolt.

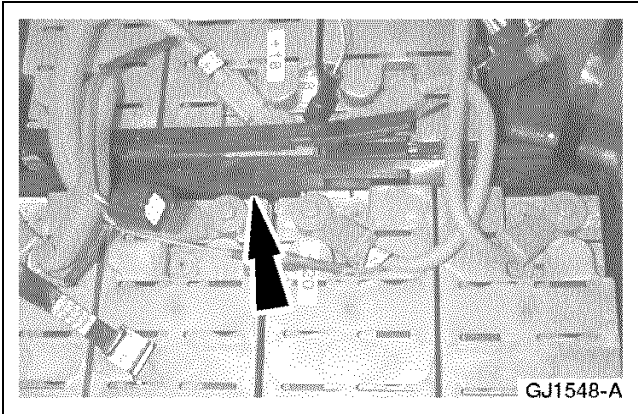

42. Remove the hold down tie bar.

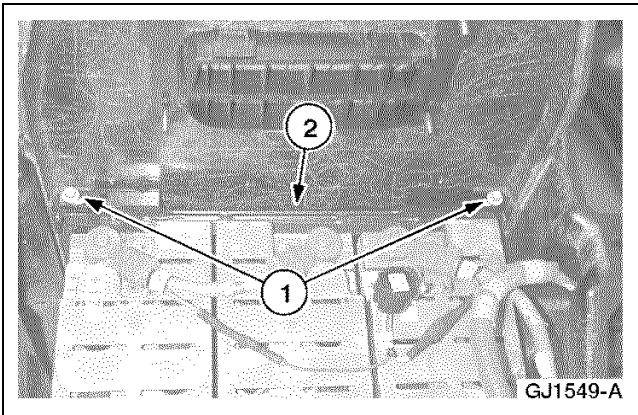

43. Remove the front battery hold down.

- 1 Remove the bolts.
- 2 Remove the hold down.

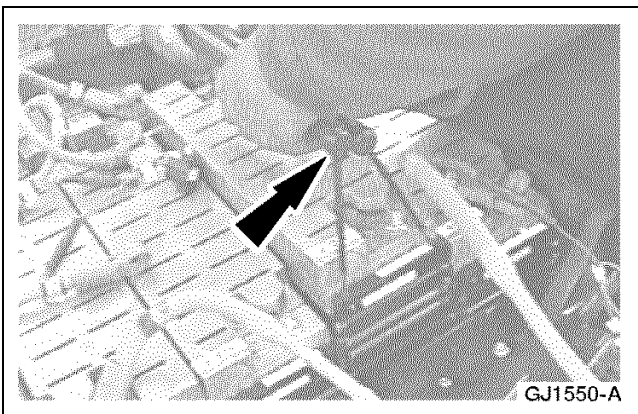

44. Remove all of the HVJs and discard the nuts.

45. Using the special tool, remove the modules.

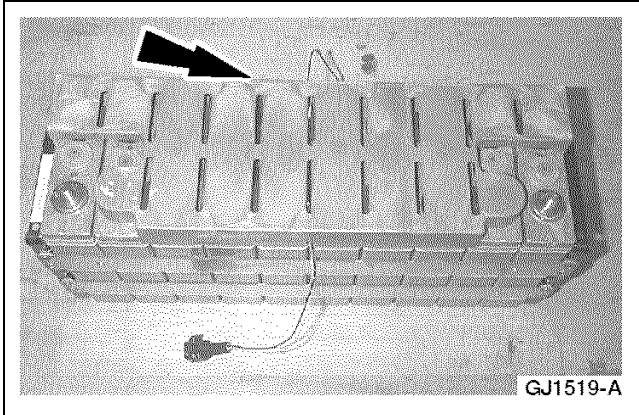
**DISASSEMBLY AND ASSEMBLY (Continued)**

46. For modules equipped with a thermistor, remove the module cover.

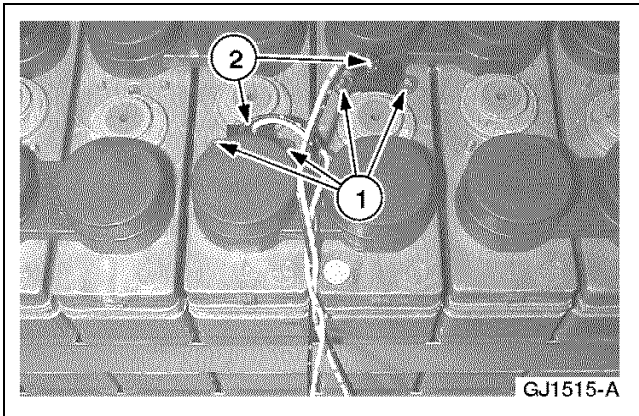

47. Remove the thermistor.
- 1 Remove the clips.
  - 2 Remove the thermistor.

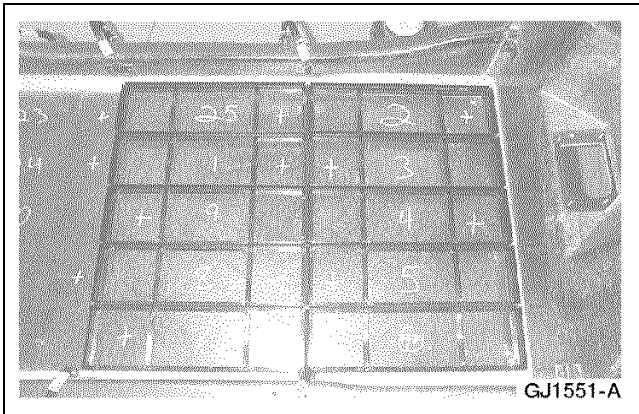
**Assembly**

1. **NOTE:** The battery supports are all the same.  
**NOTE:** The battery supports must be pressed against the bottom of the traction battery tray.  
 Install the rear battery supports.



2. **NOTE:** The battery supports are all the same.  
**NOTE:** The battery supports must be pressed against the bottom of the traction battery tray.  
 Install the middle battery supports.

## DISASSEMBLY AND ASSEMBLY (Continued)

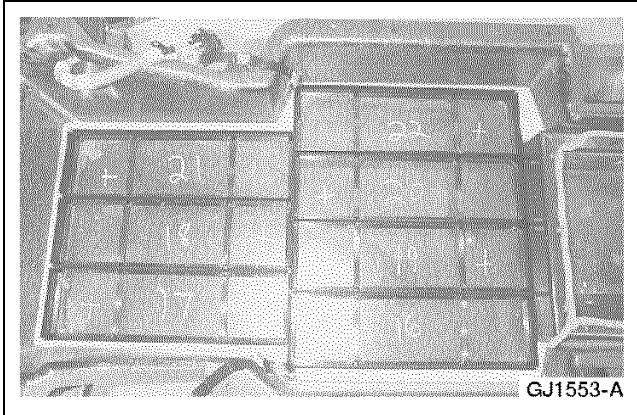

GJ1553-A

3. **NOTE:** The battery supports are all the same.  
**NOTE:** The battery supports must be pressed against the bottom of the traction battery tray.  
 Install the front battery supports.

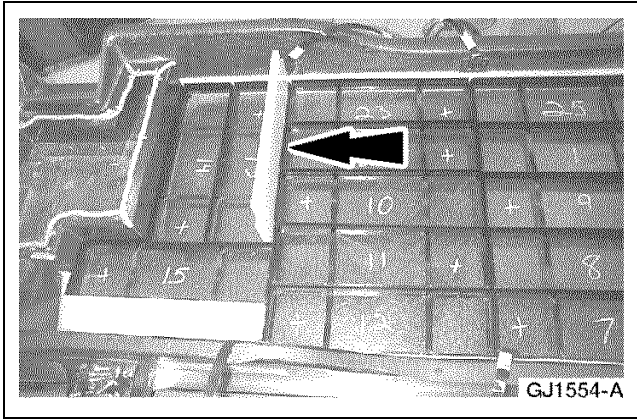

GJ1554-A

4. Install the mid-wall.

5.  **CAUTION: Do not cover the module vents with the decals.**

**NOTE:** All of the modules are the same.

Apply decals to positive (+) terminal side of the 25 modules.

6. Use the battery terminal cap opener to remove the module cap on modules 3, 12, and 18.

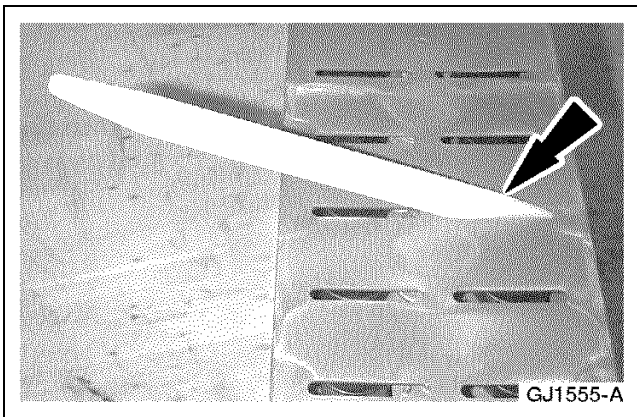

GJ1555-A

## DISASSEMBLY AND ASSEMBLY (Continued)

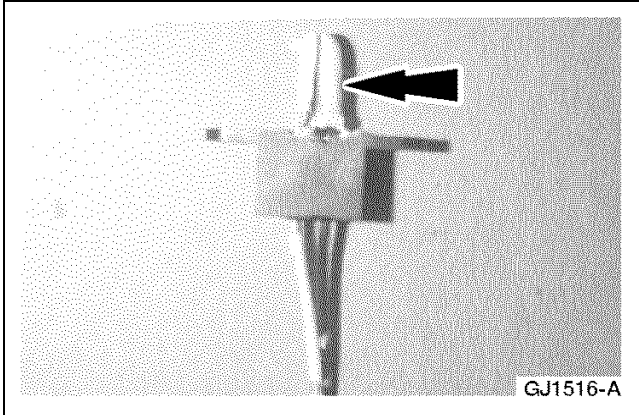

7. Apply a thin layer of thermal grease to six thermistors.

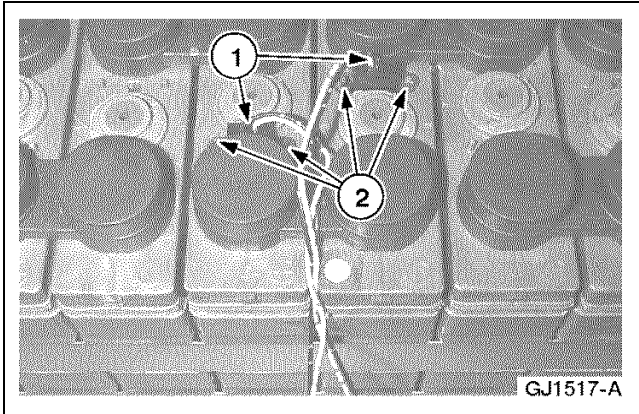

8. Install the thermistors on modules 3, 12, and 18.
  - 1 Install the thermistor.
  - 2 Install the clips.

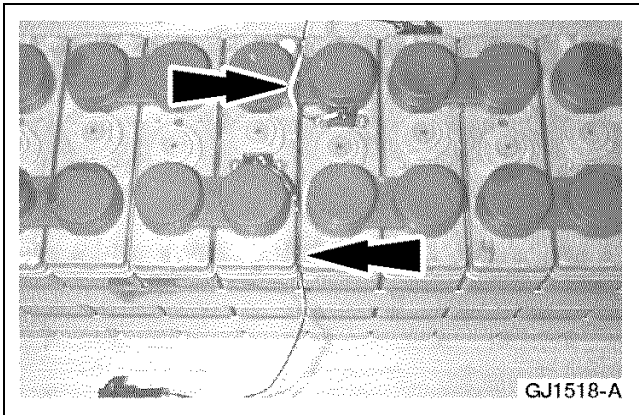

9. **NOTE:** On the module 12 thermistors, route both of the wires to the in-board side of the module.  
Route the thermistor wires along the space between the two center modules so they exit on opposite sides of the module.

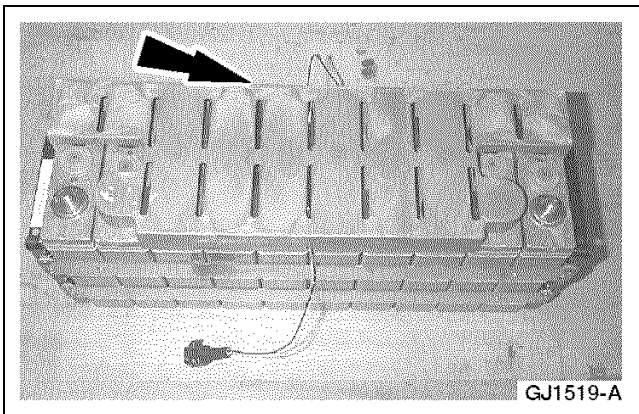

10. Install the module cover.



## DISASSEMBLY AND ASSEMBLY (Continued)

11. **NOTE:** The module orientation must be correct or the HVJs will not fit.

Install the modules into the traction battery case. Match the numbers of the modules to the numbers in the bottom of the traction battery case.

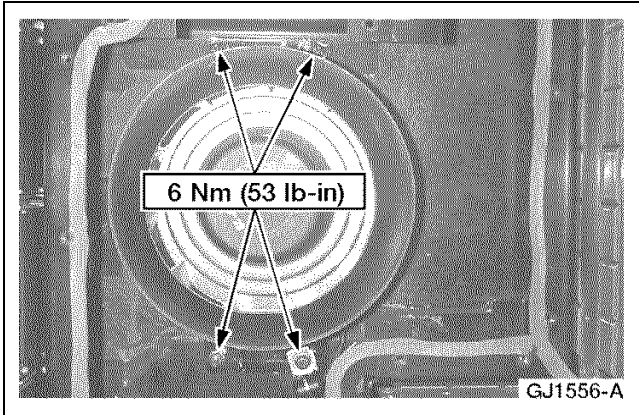

12. **NOTE:** Install the “P” clip in the same position that was noted during disassembly. Position the recirculating blower and install the nuts.

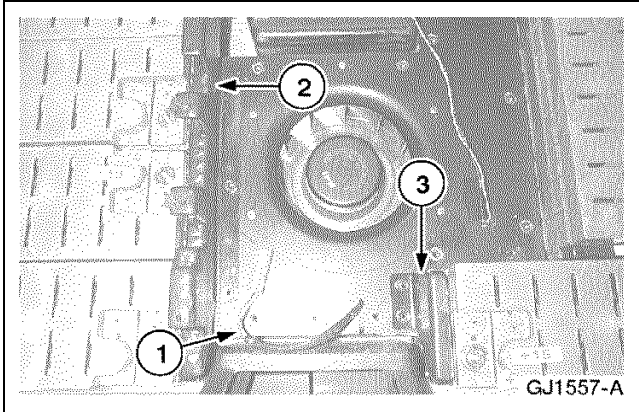

13. Install the blower cover and battery hold downs.

- 1 Install the cover.
- 2 Install the hold down.
- 3 Install the hold down.

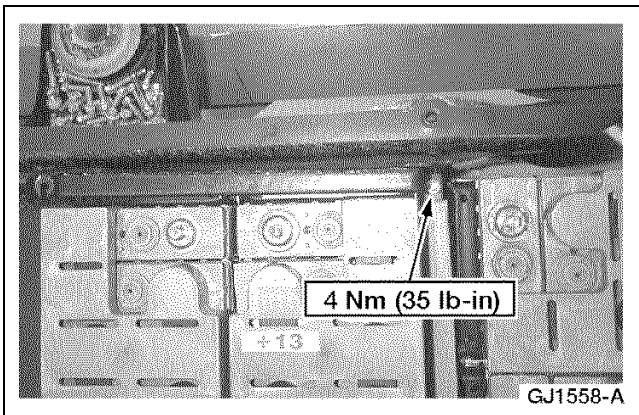

14. Install the battery hold down.

## DISASSEMBLY AND ASSEMBLY (Continued)

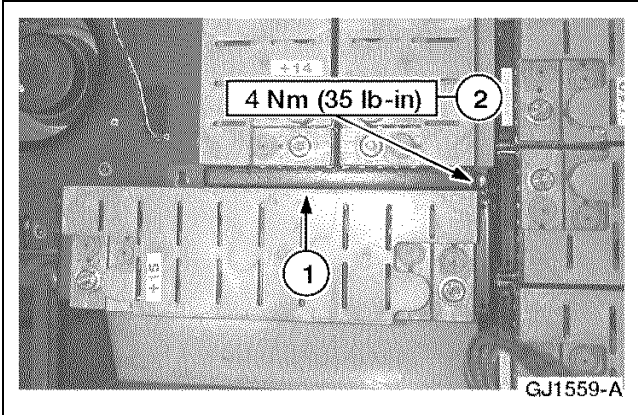

15. Install the battery hold down.

- 1 Install the hold down.
- 2 Install the bolts.

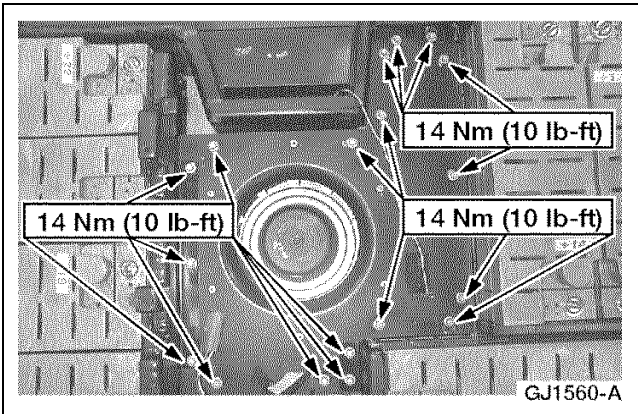

16. Install the recirculating blower cover and battery hold down bolts.

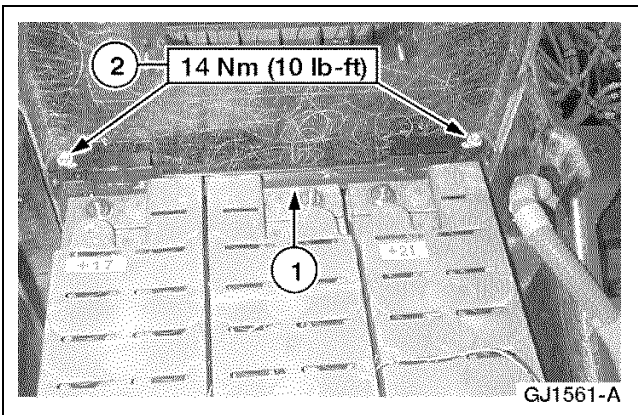

17. Install the front battery hold down.

- 1 Install the hold down.
- 2 Install the bolt.

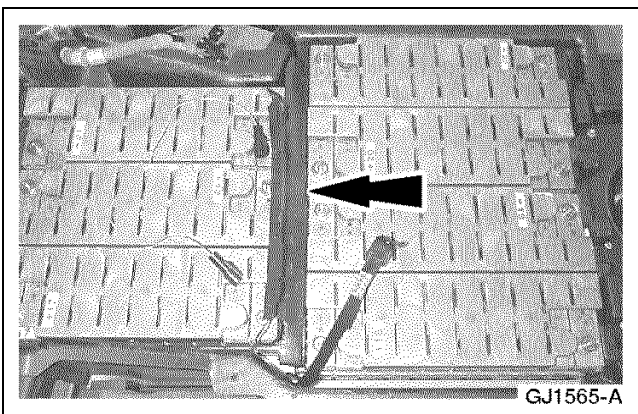

18. **NOTE:** The front battery hold down tie bar is shorter than the other battery hold down tie bars.

Install the front battery hold down tie bar with the arrow pointing towards the front of the battery pack.

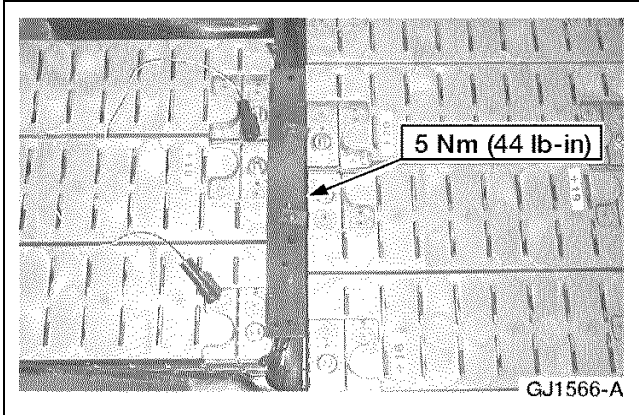
**DISASSEMBLY AND ASSEMBLY (Continued)**

19. Install the front hold down strap bolt.

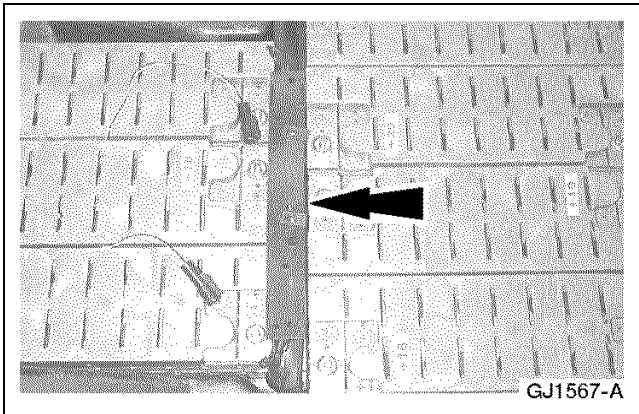

20. Clip the front battery hold down tie bar cover into place.

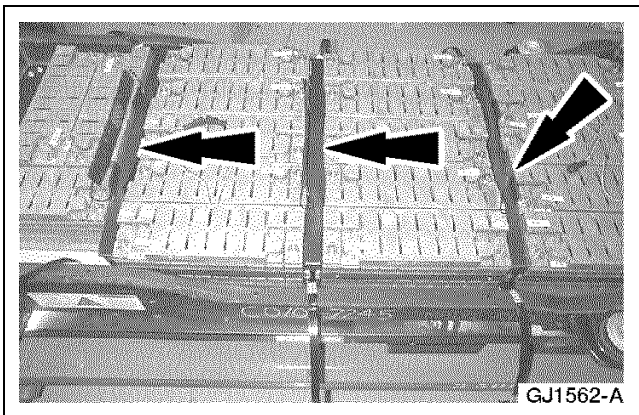

21. Install the rear battery hold down tie bars with the arrows pointing towards the front of the battery pack.

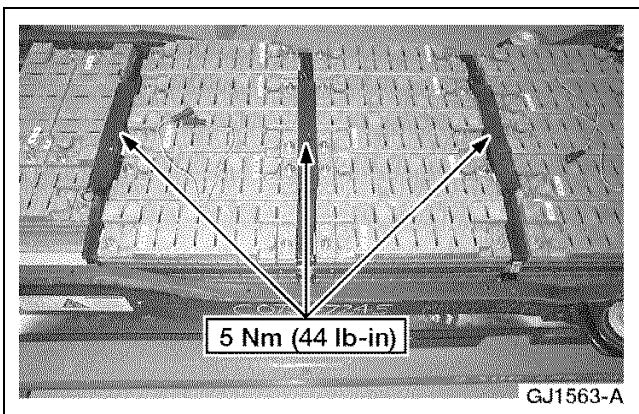

22. Install the rear hold down strap bolts.

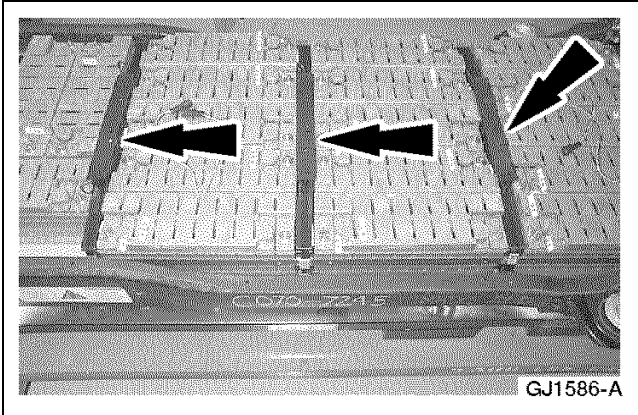
**DISASSEMBLY AND ASSEMBLY (Continued)**

23. Clip the rear battery hold down tie bar covers into place.

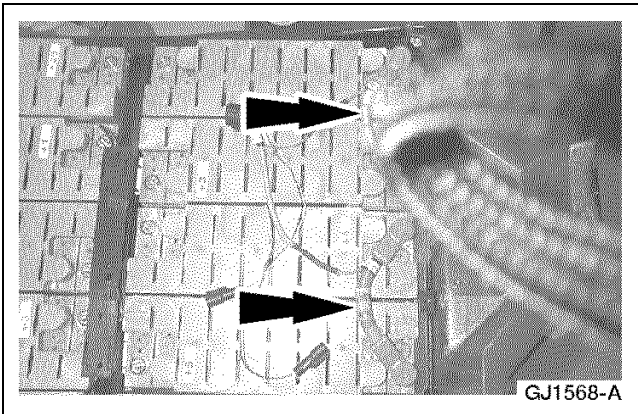

24. Install the B HVJ (2+ to 3-, 4+ to 5-) and loosely install new nuts.

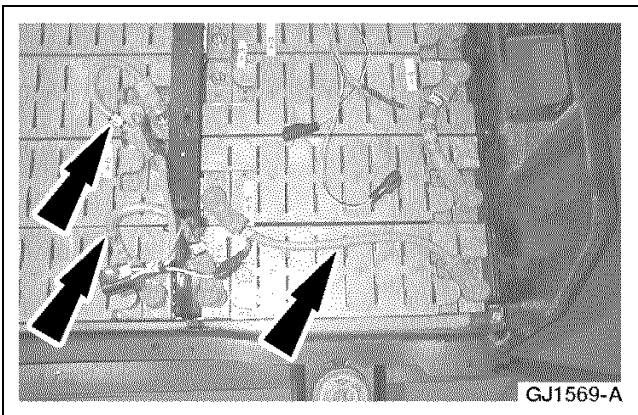

25. Install the D HVJ (5+ to 6-, 6+ to 7-, and 8+ to 9-) and loosely install new nuts.

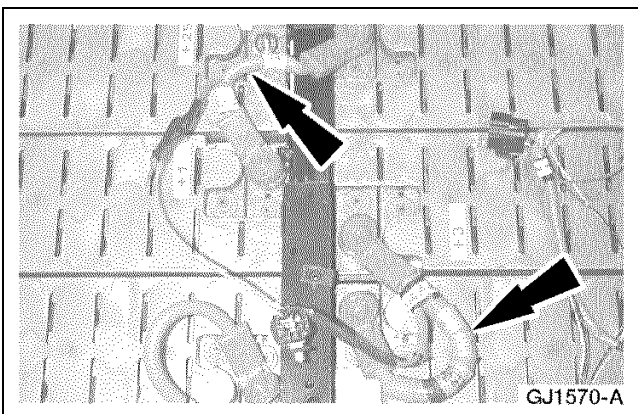

26. Install the C HVJ (1+ to 2-, 3+ to 4-) and loosely install new nuts.

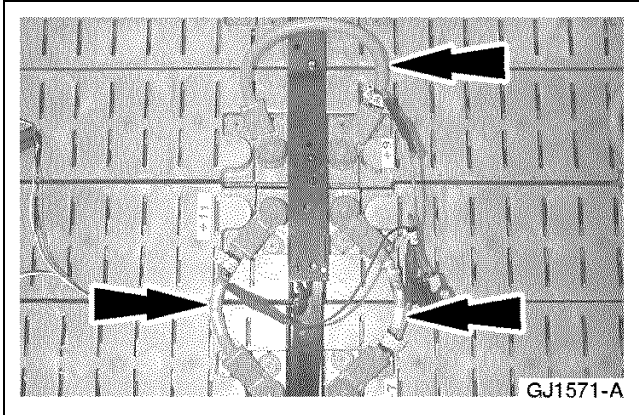
**DISASSEMBLY AND ASSEMBLY (Continued)**

27. Install the E HVJ (11+ to 12-, 9+ to 10-, 7+ to 8-) and loosely install new nuts.

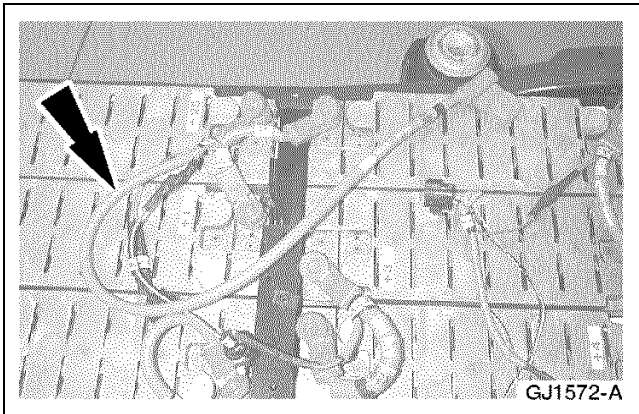

28. Install the N HVJ (25+ to contactor box +) and loosely install a new nut.

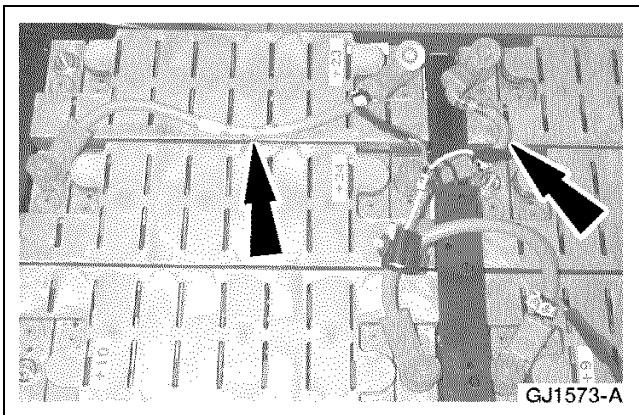

29. Install the M HVJ (24+ to 25-, 23+ to 24-) and loosely install new nuts.

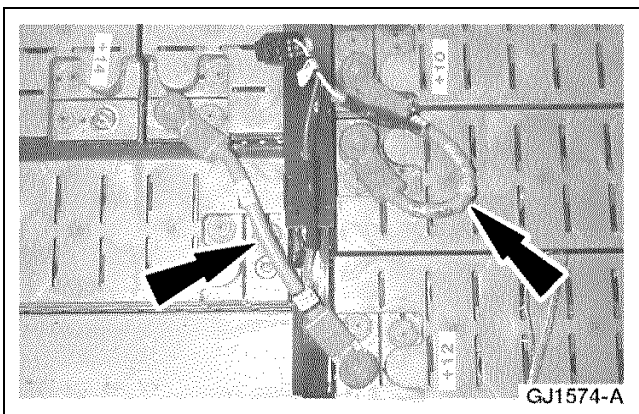

30. Install the F HVJ (10+ to 11-, 12+ to 13-) and loosely install new nuts.

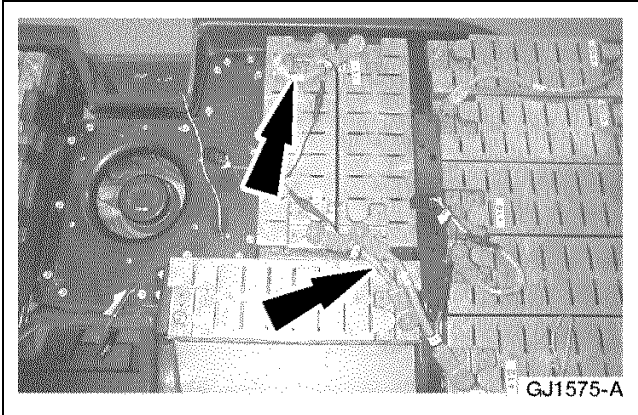
**DISASSEMBLY AND ASSEMBLY (Continued)**

31. Install the G HVJ (13+ to 14-, 14+ to 15-) and loosely install new nuts.

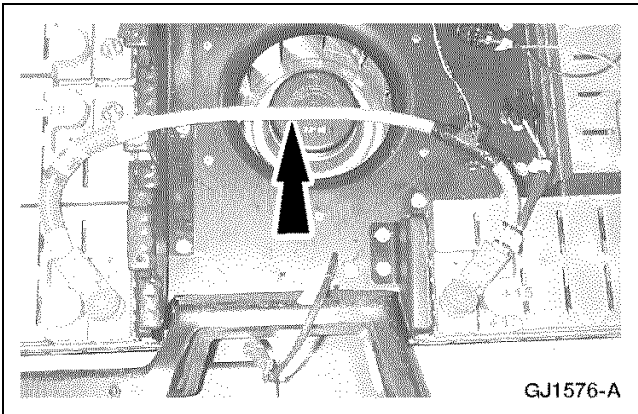

32. Install the H HVJ (15+ to 16-) and loosely install new nuts.

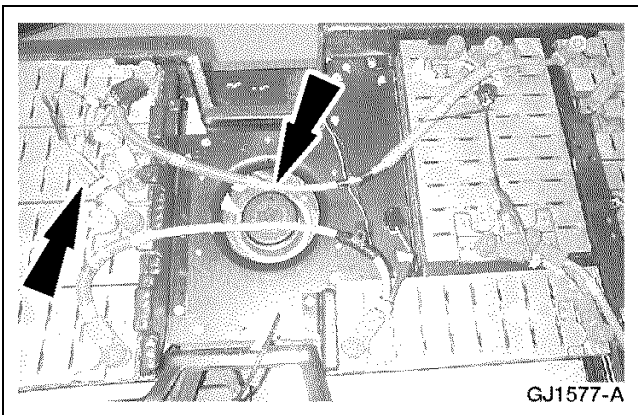

33. Install the L HVJ (22+ to 23-, 19+ to 20-) and loosely install new nuts.

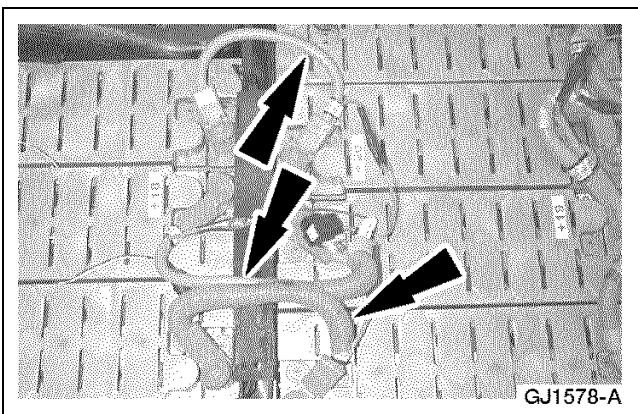

34. Install the J HVJ (16+ to 17-, 18+ to 19-, 20+ to 21-) and loosely install new nuts.

**DISASSEMBLY AND ASSEMBLY (Continued)**

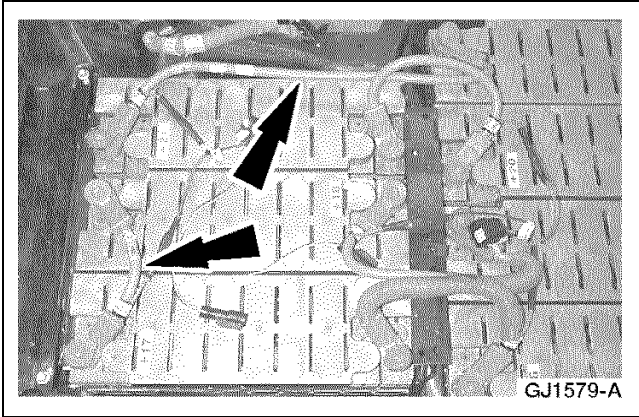

35. Install the K HVJ (17+ to 18-, 21+ to 22-) and loosely install new nuts.

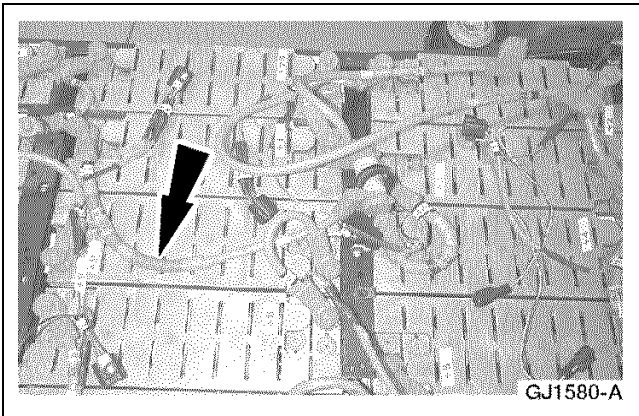

36. Install the A HVJ (1- to contactor box-) and loosely install a new nut.

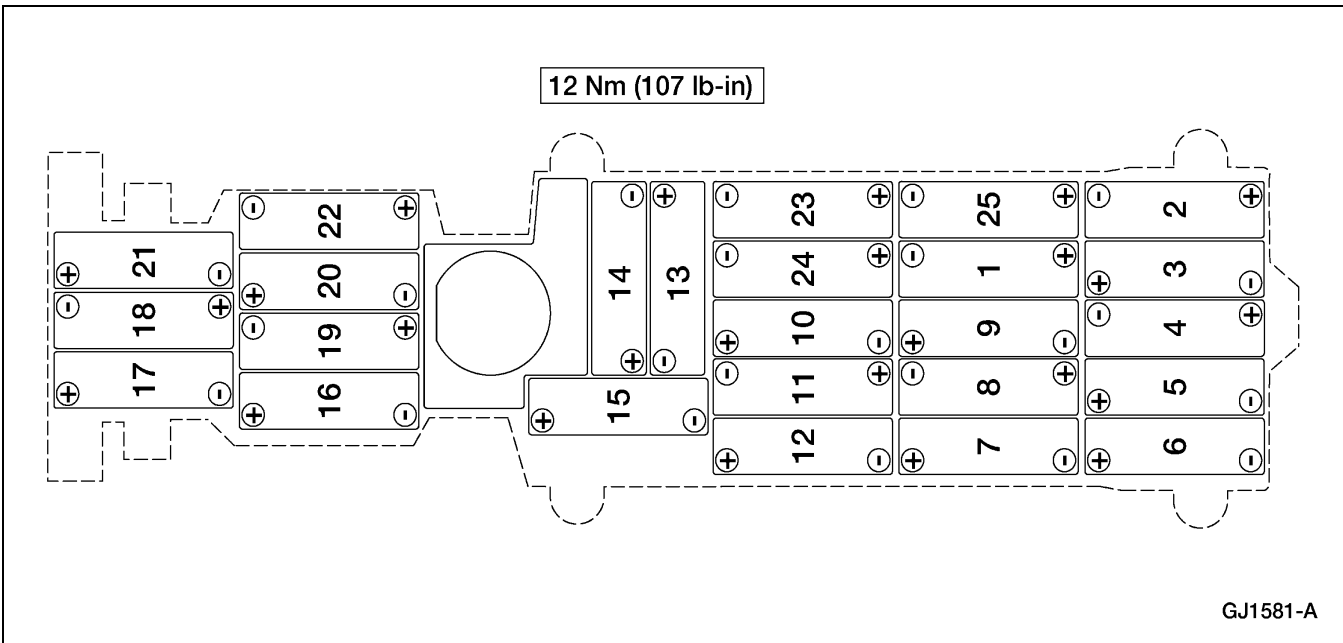

37. Tighten the HVJ nuts and fill the area around the nuts with Nyogel.

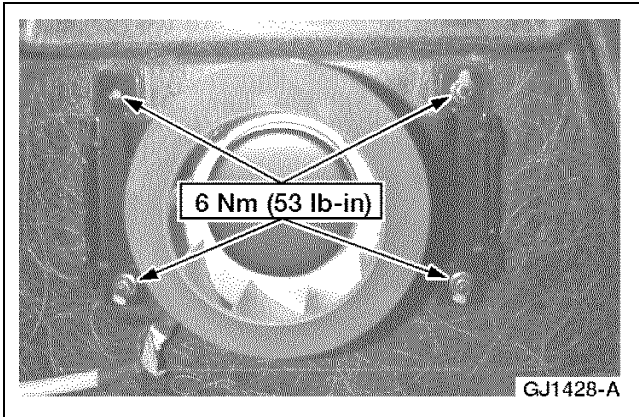
**DISASSEMBLY AND ASSEMBLY (Continued)**

38. Install the flow through blower.

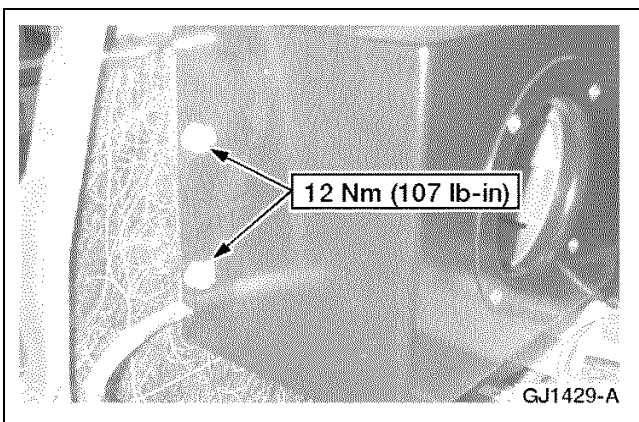

39. Install the flow through blower cover.

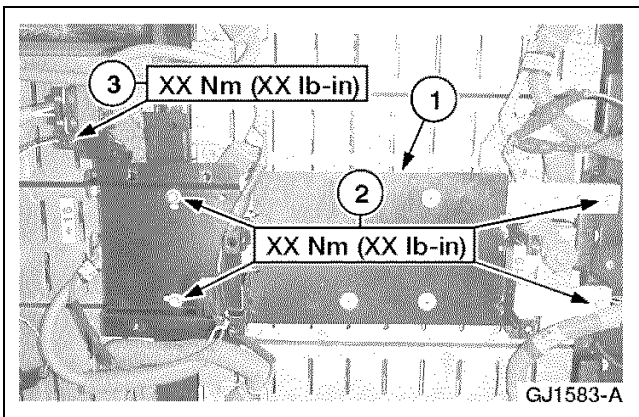

40. Install the BCM/IOM bracket.

- 1 Position the bracket.
- 2 Install the bolts.
- 3 Install the 4-pin auxiliary connector bolt.

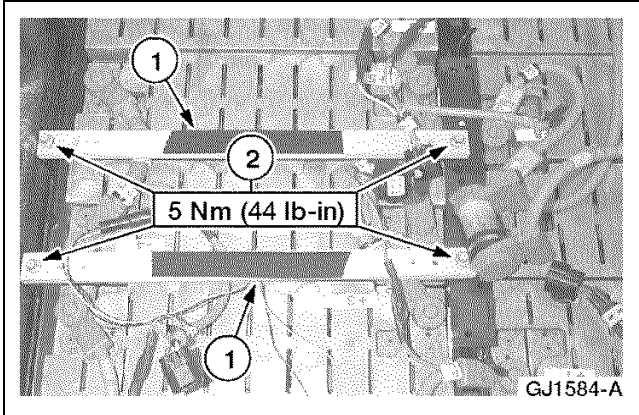

**DISASSEMBLY AND ASSEMBLY (Continued)**

41. **NOTE:** The high voltage fuse is held in place by the composite bar bolt.

Install the composite bars.

- 1 Position the bars.
- 2 Install the bolts.

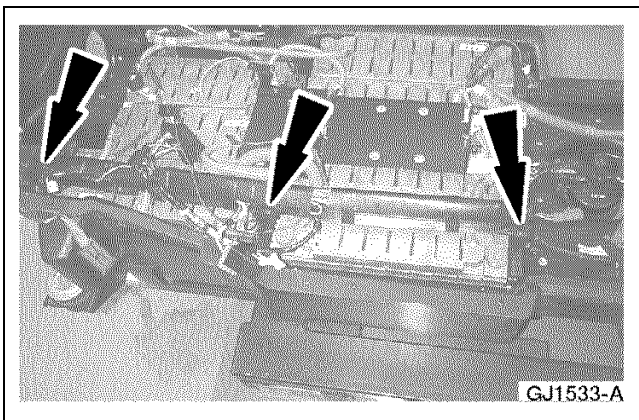

42. Position the low-voltage harness and install the pushpins.

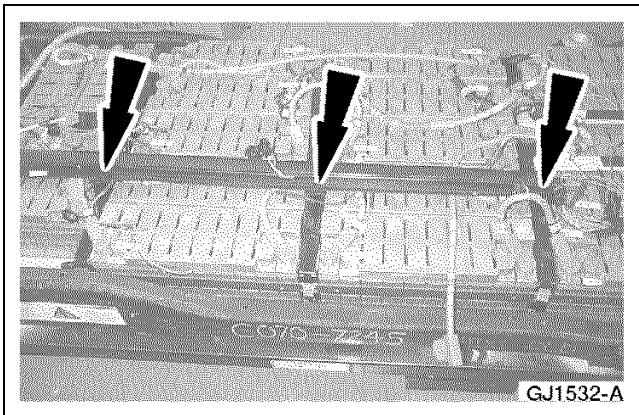

43. Install the low-voltage harness push pins.

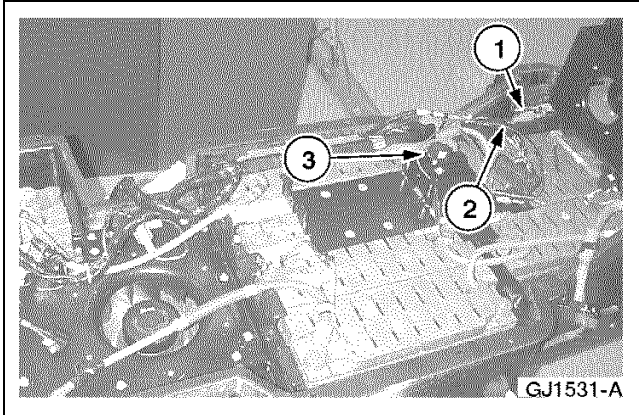
**DISASSEMBLY AND ASSEMBLY (Continued)**

44. Connect the low-voltage harness.
- 1 Connect the blower electrical connector.
  - 2 Connect the thermistor electrical connector.
  - 3 Clip the relay into place.

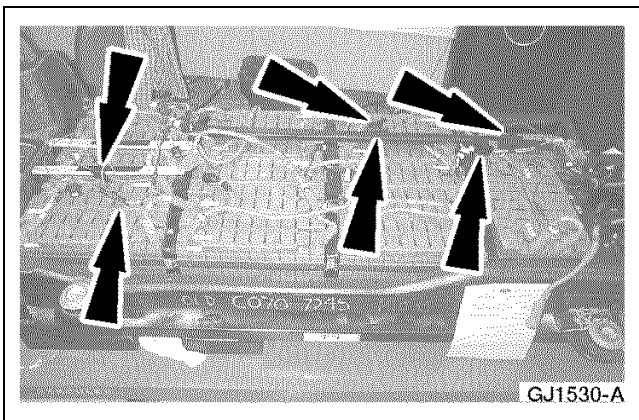

45. Connect the thermistors and clip the relay into the battery hold down tie bar covers.

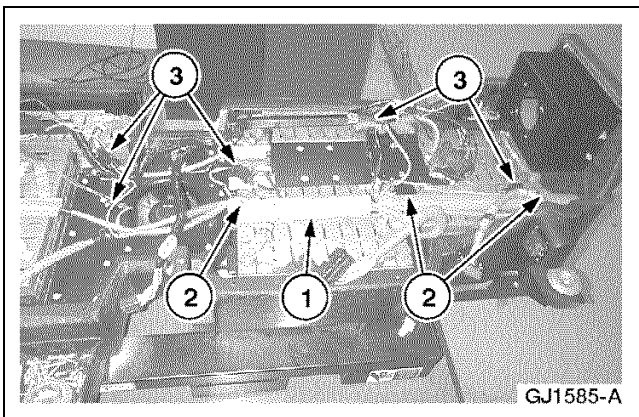

46. Install the high-voltage harness.
- 1 Position the harness.
  - 2 Install the push pins.
  - 3 Connect the sense leads.

**DISASSEMBLY AND ASSEMBLY (Continued)**

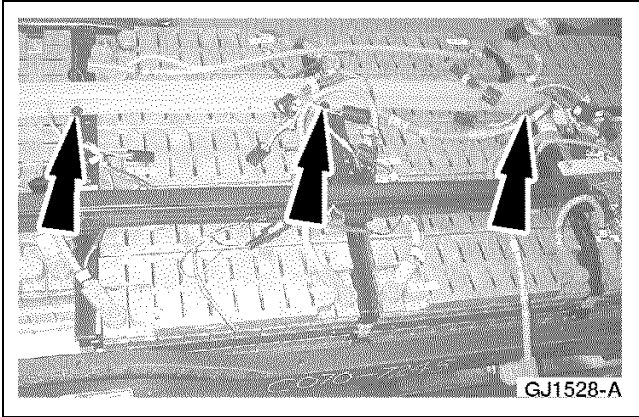

47. Install the high-voltage harness push pins.

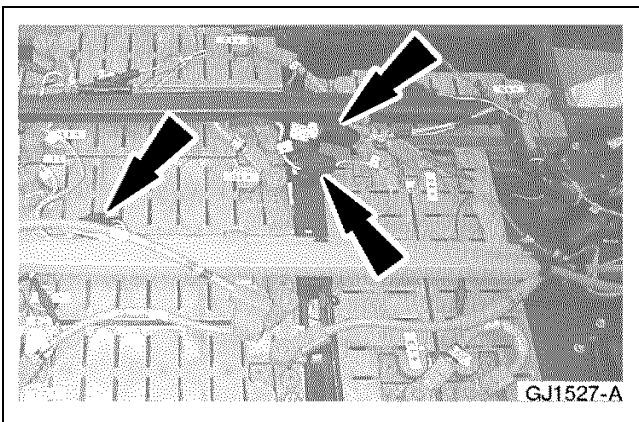

48. Connect the sense leads and clip the relay into the battery hold down tie bar cover.

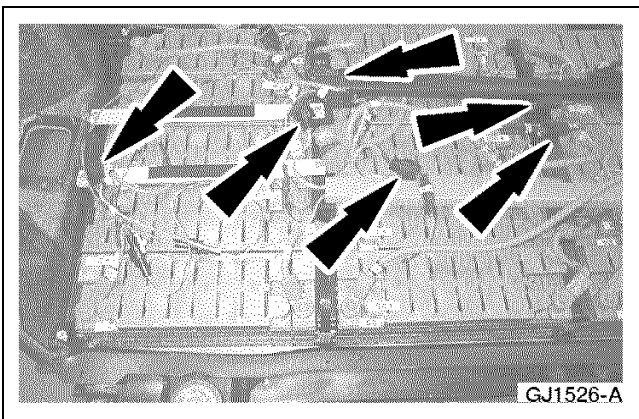

49. Connect the sense leads.

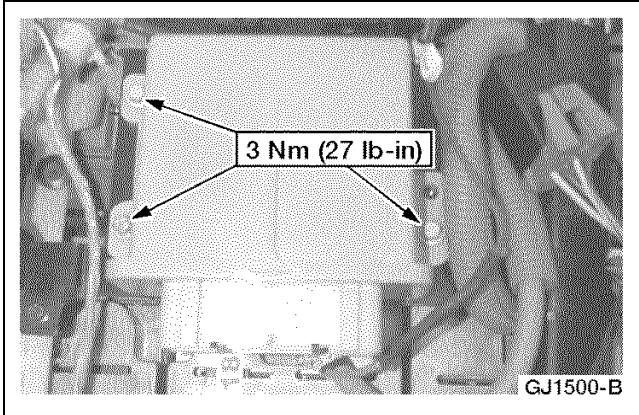
**DISASSEMBLY AND ASSEMBLY (Continued)**

50. Install the IOM and install the bolts.

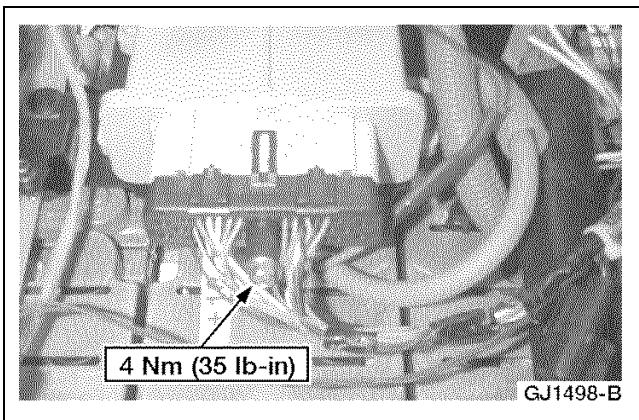

51. Connect the IOM electrical connector and tighten the bolt.

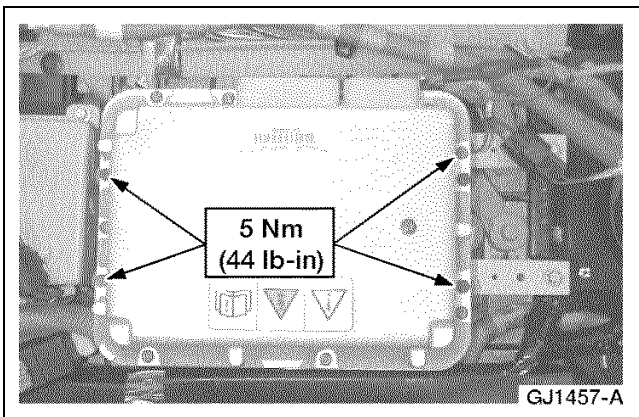

52. Position the BCM and install the bolts.

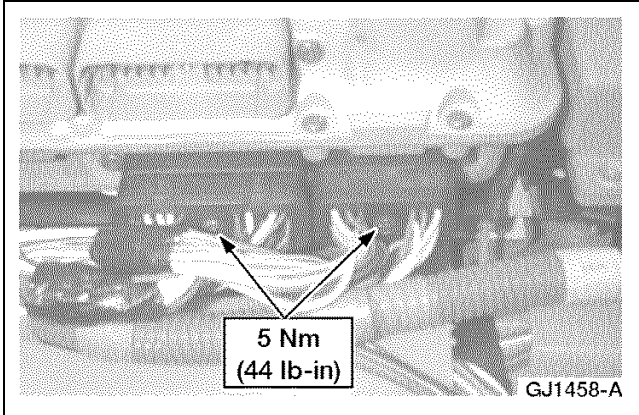
**DISASSEMBLY AND ASSEMBLY (Continued)**

53. Connect the low-voltage BCM connector and tighten the bolts.

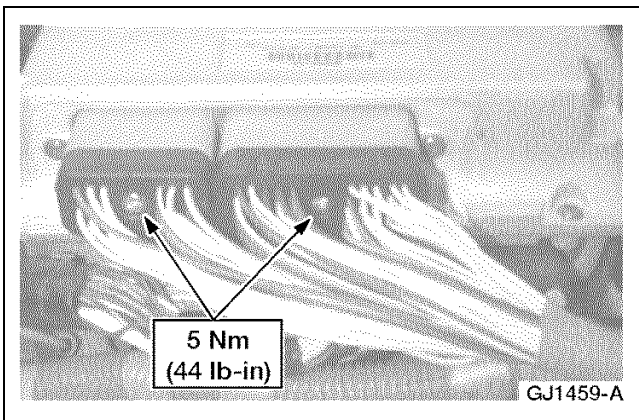

54. Connect the high-voltage BCM connector and tighten the bolts.

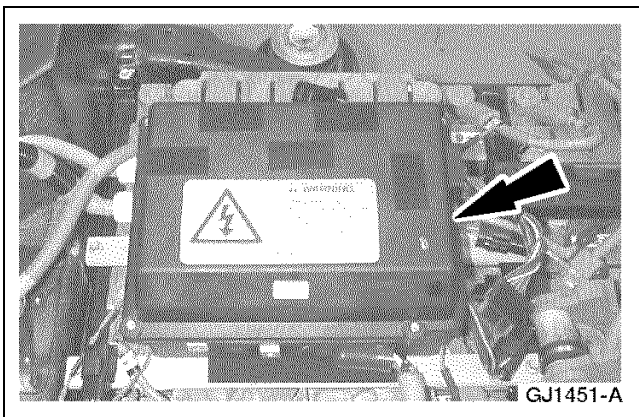

55. **NOTE:** The contactor box is held in place with strips of Velcro™.  
Install the contactor box.

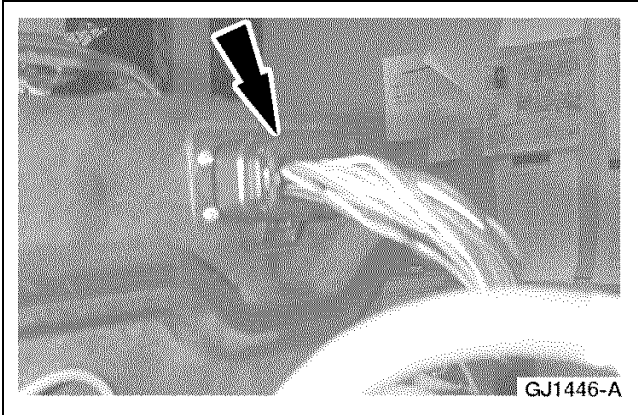
**DISASSEMBLY AND ASSEMBLY (Continued)**

56. Connect the contactor box harness.

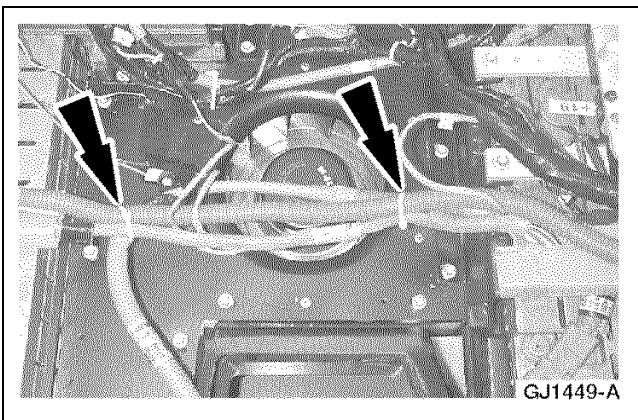

57. Instal two new zip ties to secure the high-voltage harness.

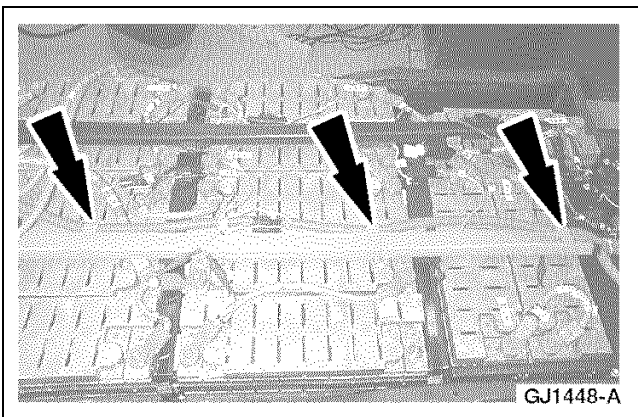

58. Clip the contactor box harness to the high-voltage harness.

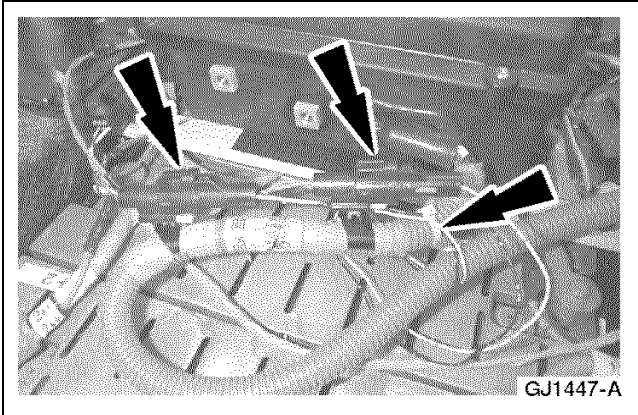
**DISASSEMBLY AND ASSEMBLY (Continued)**

59. Clip the thermistors into the contactor box harness and install a zip tie to secure the thermistor wires.

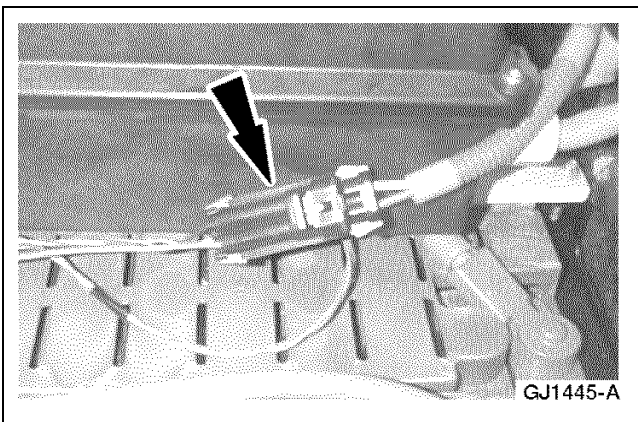

60. Connect the high-voltage interlock electrical connector.

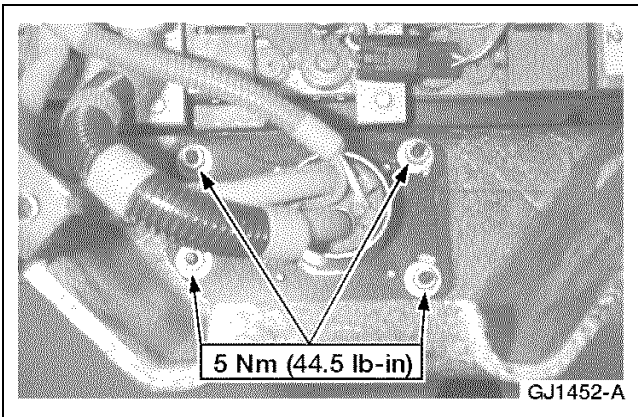

61. Position the two-pin high-voltage connector and install the nuts.

## DISASSEMBLY AND ASSEMBLY (Continued)

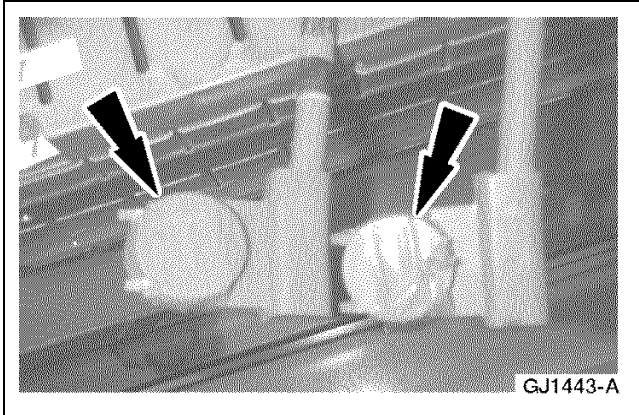

62. Remove the orange electrical tape from the HVJ ends.

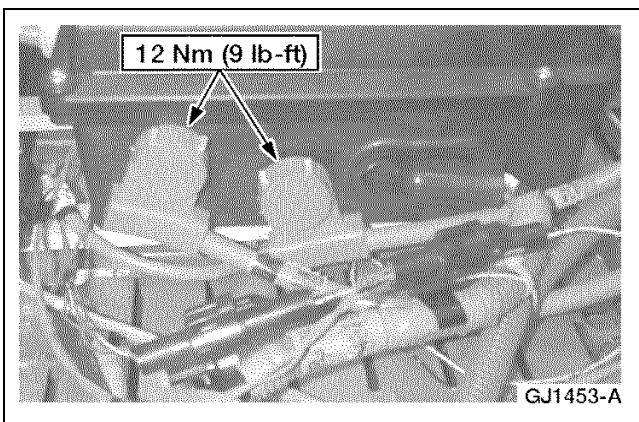

63. **NOTE:** The HVJ from module 25 connects to the “+” terminal on the contactor box, the HVJ from module 1 connects to the “-” terminal on the contactor box.

Connect the HVJ ends to the contactor box and install the nuts.

- Fill the area around the nuts with Nyogel.

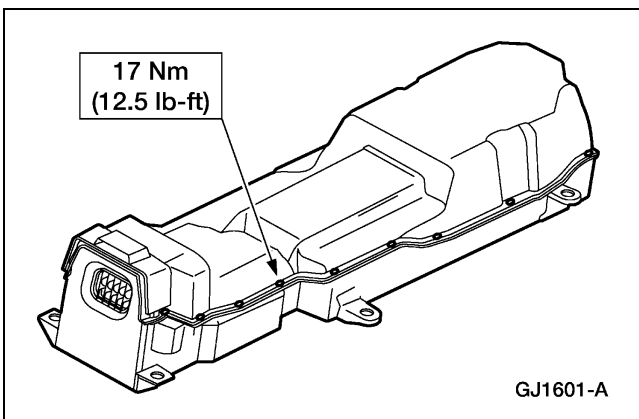

64. Install the traction battery cover.
- Install the 22 bolts.
  - Apply Loctite 242 (Threadlock and Sealer) to the bolts prior to installation.

65. Install the traction battery. Refer to [Traction Battery](#).



Manual Table of Contents

# SECTION 418-00 Module Communications Network

VEHICLE APPLICATION: Ranger EV

CONTENTS	PAGE
<b>DESCRIPTION AND OPERATION</b>	
Module Communication .....	418-00-2
<b>DIAGNOSIS AND TESTING</b>	
Communications Network.....	418-00-3
Electrical Schematic .....	418-00-3
Inspection and Verification .....	418-00-3
Pinpoint Tests.....	418-00-4
Symptom Chart .....	418-00-4
System Precheck.....	418-00-3

## DESCRIPTION AND OPERATION

### Module Communication

The Electric Ranger has two module communications networks. The standard corporate protocol (SCP) communications network, which is an unshielded twisted pair cable (data bus plus, circuit 914 and data bus minus, circuit 915) and the international standards organization (ISO) 9141 communications network, which is a single wire network (circuit 70 [W]). Both networks can be connected to NGS Tester at one connector called the data link connector (DLC). This makes troubleshooting these systems easier by allowing one smart tester to be able to diagnose and control any module on the two networks. The DLC can be found under the instrument panel between the steering column and the radio.

The ISO 9141 communication network does not permit inter-module communication. When the NGS tester communicates to modules on the ISO 9141 communication network, the NGS tester must ask for all information; the modules cannot initiate communications.

The SCP communications network allows inter-module communication and will remain operational even with the severing of one of the bus wires. Communication will also continue if one of the bus wires is shorted to ground or battery positive voltage (B+) or if a termination resistor is lost. This faulted condition is detected and reported to the host by the module's network bus interface circuits.

Unlike the SCP communications network, the ISO 9141 communications network will not function if the wire is shorted to ground or battery positive voltage (B+). Also, if one of the modules on the ISO 9141 communications network loses power or shorts internally, communications to that module or all modules, will fail.

### Standard Corporate Protocol (SCP) Communication Network

The battery control module (BCM), interface adapter assembly (IAA) module, and traction inverter module (TIM) operate using the SCP communications network.

The BCM is located in the upper front section of the traction battery and controls all of the traction battery systems. The module controls traction battery charging and cooling, and operates the traction battery self-heating system for cold climate operation. Maximum current flow out and into the traction battery is also controlled by the BCM. In addition to controlling the traction battery systems, the BCM monitors the traction battery state of charge and sends the information to the IAA which sends a signal to the instrument cluster State of Charge gauge. Refer to [Section 414-03A](#) or [Section 414-03B](#).

The IAA module location is the standard Ranger powertrain control module location, which is in the passenger side bulkhead in the engine compartment. The IAA module controls the climate control system, power steering, direct current to direct current (DC/DC) converter, vacuum pump, coolant pump, and radiator coolant fan operation. The module also operates a number of instrument cluster gauges and warning lamps. Refer to [Section 412-04](#).

The TIM is located in the rear of the vehicle, behind the motor/transaxle and below the pickup box. The TIM converts high voltage direct current (DC) from the traction battery into high voltage alternating current (AC) to power the motor/transaxle. Output from the TIM to the motor/transaxle is varied to control the torque applied to the driven wheels based upon sensor inputs and driver demands. Refer to [Section 303-14](#).

### International Standards Organization (ISO) 9141 Communications Network

The anti-lock brake control module, central timer module (CTM), and the electronic crash sensor (ECS) module operate using the ISO 9141 communications network.

The anti-lock brake control module is mounted on the hydraulic control unit, which is located in the underhood compartment on the driver side near the inner fender. The module modulates brake line pressure to prevent wheel lock-up under heavy braking. Refer to [Section 206-09](#).

**DESCRIPTION AND OPERATION (Continued)**

The CTM is mounted to the instrument panel behind the radio. The CTM controls essential and convenience features, such as windshield wipers, chime functions, and door ajar indication. Refer to **Section 419-10 of the Ranger Workshop Manual** .

The ECS module is located behind the instrument panel next to the plenum assembly. The module controls the air bag deployment in a crash situation. Refer to **Section 418-00 and Section 501-20 of the Ranger Workshop Manua**.

**DIAGNOSIS AND TESTING**

**Communications Network**

**Electrical Schematic**

Refer to **Electrical and Vacuum Troubleshooting Manual, Cell 14, Multiplex Communication Network** for schematic and connector information.

**System Precheck**

**Inspection and Verification**

Refer to [Section 100-07](#).

**PINPOINT TEST PC: DATA LINK DIAGNOSTICS NETWORK TEST**

TEST STEP	ACTION TO TAKE
<p><b>PC1 DATA LINK DIAGNOSTICS NETWORK TEST</b></p> <ul style="list-style-type: none"> <li>• Run the DATA LINK DIAGNOSTICS Network Test.</li> <li>• Is <b>SYSTEM PASSED</b> obtained?</li> </ul>	<p>Yes = Test PASSED.</p> <p>No = If no response from NGS, GO to <a href="#">Pinpoint Test G</a>.</p> <p>If CKT70, CKT914, and/or CKT915 = SOME MODULES NOT RESP/NOT EQUIP, REFER to <a href="#">Symptom Chart</a>.</p> <p>If CKT70 = ALL MODULES NO RESP/NOT EQUIP, GO to <a href="#">Pinpoint Test E</a>.</p> <p>If CKT914 = ALL MODULES NO RESP/NOT EQUIP, GO to <a href="#">Pinpoint Test F</a>.</p> <p>If CKT915 = ALL MODULES NO RESP/NOT EQUIP, GO to <a href="#">Pinpoint Test F</a>.</p> <p>If module in question is NO RESPONSE/NOT EQUIPPED, REFER to <a href="#">Symptom Chart</a>.</p> <p>If module in question is NO RESPONSE ON CKT914 (BUS+), REFER to <a href="#">Symptom Chart</a>.</p> <p>If module in question is NO RESPONSE ON CKT915 (BUS-), REFER to <a href="#">Symptom Chart</a>.</p>

**DIAGNOSIS AND TESTING (Continued)****Symptom Chart****Symptom Chart**

Condition	Possible Sources	Action
<ul style="list-style-type: none"> <li>The Module Does Not Respond to the NGS Tester —Anti-Lock Brake Control Module</li> </ul>	<ul style="list-style-type: none"> <li>Wire or connection in ISO 9141 link circuit.</li> <li>Anti-lock brake control module.</li> </ul>	<ul style="list-style-type: none"> <li>GO to <a href="#">Pinpoint Test A.</a></li> </ul>
<ul style="list-style-type: none"> <li>The Module Does Not Respond to the NGS Tester —Battery Control Module (BCM)</li> </ul>	<ul style="list-style-type: none"> <li>Wire or connection in SCP circuit.</li> <li>Battery control module (BCM).</li> </ul>	<ul style="list-style-type: none"> <li>GO to <a href="#">Pinpoint Test B.</a></li> </ul>
<ul style="list-style-type: none"> <li>The Module Does Not Respond to the NGS Tester —Interface Adapter Assembly (IAA) Module</li> </ul>	<ul style="list-style-type: none"> <li>Wire or connection in SCP circuit.</li> <li>Interface adapter assembly (IAA) module.</li> </ul>	<ul style="list-style-type: none"> <li>GO to <a href="#">Pinpoint Test C.</a></li> </ul>
<ul style="list-style-type: none"> <li>The Module Does Not Respond to the NGS Tester —Traction Inverter Module (TIM)</li> </ul>	<ul style="list-style-type: none"> <li>Wire or connection in SCP circuit.</li> <li>Traction inverter module (TIM).</li> </ul>	<ul style="list-style-type: none"> <li>GO to <a href="#">Pinpoint Test D.</a></li> </ul>
<ul style="list-style-type: none"> <li>No Module/Network Communication —ISO 9141 Link</li> </ul>	<ul style="list-style-type: none"> <li>Wire or connection in ISO circuit.</li> <li>ISO link modules.</li> </ul>	<ul style="list-style-type: none"> <li>GO to <a href="#">Pinpoint Test E.</a></li> </ul>
<ul style="list-style-type: none"> <li>No Module/Network Communication —SCP Link</li> </ul>	<ul style="list-style-type: none"> <li>Wire or connection in SCP link circuit.</li> <li>SCP link modules.</li> </ul>	<ul style="list-style-type: none"> <li>GO to <a href="#">Pinpoint Test F.</a></li> </ul>
<ul style="list-style-type: none"> <li>No Module/Network Communication</li> </ul>	<ul style="list-style-type: none"> <li>Data link connector (DLC).</li> <li>Fuse.</li> <li>Circuitry.</li> <li>NGS Tester.</li> </ul>	<ul style="list-style-type: none"> <li>GO to <a href="#">Pinpoint Test G.</a></li> </ul>

**Pinpoint Tests****Special Tool(s)**

104-Pin Breakout Box (BOB) 418-049 (014-00950) or equivalent
BCM/TIM Breakout Box (BOB) Adapter Cable 418-F212
BCM/TIM Breakout Box (BOB) Overlay 418-F220
Traction Battery Low Voltage Service Cord 418-F219

**PINPOINT TEST A: THE MODULE DOES NOT RESPOND TO THE NGS TESTER —ANTI-LOCK BRAKE CONTROL MODULE**

TEST STEP	ACTION TO TAKE
<b>A1 CHECK CIRCUIT 70 (LB/W) BETWEEN DATA LINK CONNECTOR (DLC) C209 AND ANTI-LOCK BRAKE CONTROL MODULE C1942 FOR OPEN</b> <ul style="list-style-type: none"> <li>With key OFF, disconnect anti-lock brake control module C1942 and NGS Tester. Inspect anti-lock brake control module C1942 and DLC C209 for damage.</li> <li>With key OFF, measure the resistance of the LB/W wire between pin 23 on the anti-lock brake control module C1942 and pin 7 on DLC C209.</li> <li><b>Are the connectors OK and is the resistance less than 5 ohms?</b></li> </ul>	Yes = GO to <b>A2.</b>  No = GO to <b>A3.</b>

(Continued)

**DIAGNOSIS AND TESTING (Continued)****PINPOINT TEST A: THE MODULE DOES NOT RESPOND TO THE NGS TESTER —ANTI-LOCK BRAKE CONTROL MODULE**

TEST STEP	ACTION TO TAKE
<b>A2 CHECK ANTI-LOCK BRAKE CONTROL MODULE C1942 CONNECTION</b> <ul style="list-style-type: none"> <li>Reconnect anti-lock brake control module C1942 and rerun DATA LINK DIAGNOSTICS Network Test.</li> <li><b>Does the anti-lock brake control module respond to NGS Tester?</b></li> </ul>	Yes = System OK. No = REPLACE the anti-lock brake control module. REFER to <a href="#">Section 206-09</a> .
<b>A3 CHECK CIRCUIT 70 (LB/W) BETWEEN IN-LINE C1946F AND DLC C209 FOR OPEN</b> <ul style="list-style-type: none"> <li>With key OFF, disconnect in-line C1946F (evac/fill connector #1) from in-line C1941M (evac/fill connector #2) and inspect C1946F and C1941M for damage.</li> <li>With key OFF, measure the resistance of the LB/W wire between pin 7 on in-line C1946F and pin 7 on DLC C209.</li> <li><b>Are the connectors OK and is the resistance less than 5 ohms?</b></li> </ul>	Yes = REPAIR the LB/W wire between in-line C1941M and anti-lock brake control module C1942. No = GO to A4.
<b>A4 CHECK CIRCUIT 70 (LB/W) BETWEEN IN-LINE C134F AND DLC C209 FOR OPEN</b> <ul style="list-style-type: none"> <li>With key OFF, disconnect in-line C134 and inspect C134M and C134F for damage.</li> <li>With key OFF, measure the resistance of the LB/W wire between pin 16 on in-line C134F and pin 7 on DLC C209.</li> <li><b>Are the connectors OK and is the resistance less than 5 ohms?</b></li> </ul>	Yes = REPAIR the LB/W wire between in-line C134M and in-line C1946F. No = REPAIR the connectors and/or the LB/W wire between in-line C134F and DLC C209.

**PINPOINT TEST B: THE MODULE DOES NOT RESPOND TO THE NGS TESTER —BATTERY CONTROL MODULE (BCM)**

TEST STEP	ACTION TO TAKE
<b>B1 CHECK FUSE, POWER, AND GROUND TO TRACTION BATTERY SUPPORT TRAY</b> <ul style="list-style-type: none"> <li>Check 10A fuse 12 in the electric vehicle power distribution box (EVPDB).</li> <li>With key OFF, disconnect traction battery support tray in-line C1939 and NGS Tester. Inspect C1939M, C1939F and DLC C209 for damage.</li> <li>Connect 104-Pin Breakout Box (BOB) to traction battery support tray in-line C1939 using Traction Battery Low Voltage Service Cord.</li> <li>With key OFF, measure the voltage between BOB pins 45, 53 and ground (BOB pin 65). (V &gt; 10 volts)</li> <li>With key OFF, measure the resistance between BOB pins 1, 37 and ground. (R &lt; 5 ohms)</li> <li><b>Is everything OK?</b></li> </ul>	Yes = GO to B2. No = REPAIR as necessary.
<b>B2 CHECK CIRCUITS 914 (T/O) AND 915 (PK/LB) BETWEEN IN-LINE C1939M AND DATA LINK CONNECTOR (DLC) C209 FOR OPEN(S)</b> <ul style="list-style-type: none"> <li>With key OFF, measure the resistance of the T/O wire between pin 2 on DLC C209 and BOB pin 59.</li> <li>With key OFF, measure the resistance of the PK/LB wire between pin 10 on DLC C209 and BOB pin 58.</li> <li><b>Are the resistances less than 5 ohms?</b></li> </ul>	Yes = GO to B4. No = GO to B3.
<b>B3 CHECK CIRCUITS 914 (T/O) AND 915 (PK/LB) BETWEEN IN-LINE C1939M AND IN-LINE C136M FOR OPEN(S)</b>	

(Continued)

**DIAGNOSIS AND TESTING (Continued)****PINPOINT TEST B: THE MODULE DOES NOT RESPOND TO THE NGS TESTER —BATTERY CONTROL MODULE (BCM)**

TEST STEP	ACTION TO TAKE
<ul style="list-style-type: none"> <li>• With key OFF, disconnect in-line C136 and inspect C136M and C136F for damage.</li> <li>• With key OFF, measure the resistance of the T/O wire between pin 25 on in-line C136M and BOB pin 59.</li> <li>• With key OFF, measure the resistance of the PK/LB wire between pin 21 on in-line C136M and BOB pin 58.</li>   <li>• <b>Are the connectors OK and are the resistances less than 5 ohms?</b></li> </ul>	<p>Yes = REPAIR the wire in question between in-line C136F and DLC C209. REFER to Communication Circuit Wiring Repair — Module in <b>Section 418-00 of the 2001 Ranger Workshop Manual.</b></p> <p>No = REPAIR the connectors and/or the wire in question between in-line C1939M and in-line C136M. REFER to Communication Circuit Wiring Repair —Module in <b>Section 418-00 of the 2001 Ranger Workshop Manual.</b></p>
<p><b>B4 CHECK CIRCUITS 914 (T/O), 915 (PK/LB), 787 (PK/BK), 787 (PK/BK), 570 (BK/W), AND 57 (BK) BETWEEN IN-LINE C1939F AND BATTERY CONTROL MODULE (BCM) C1986, C1987 FOR OPEN(S)</b></p> <p> <b>WARNING: The traction battery contains high-voltage components. High-voltage insulated safety gloves and face shield must be worn when performing the following steps. Failure to follow this warning may result in severe personal injury or death.</b></p> <ul style="list-style-type: none"> <li>• Remove the traction battery.</li> </ul> <p><b>NOTE:</b> There are two power feeds to the BCM with the same circuit number/wire color; circuit 787 (PK/BK wire). When performing continuity tests for these wires, pay close attention to the indicated pins.</p> <ul style="list-style-type: none"> <li>• With key OFF, disconnect BCM C1986, C1987 and inspect for damage.</li> <li>• With key OFF, measure the resistance of the T/O wire between pin 21 on BCM C1987 and BOB pin 59.</li> <li>• With key OFF, measure the resistance of the PK/LB wire between pin 20 on BCM C1987 and BOB pin 58.</li> <li>• With key OFF, measure the resistance of the PK/BK wire between pin 10 on BCM C1986 and BOB pin 53.</li> <li>• With key OFF, measure the resistance of the PK/BK wire between pin 20 on BCM C1986 and BOB pin 45.</li> <li>• With key OFF, measure the resistance of the BK/W wire between pins 4, 5 on BCM C1986 and BOB pin 37.</li> <li>• With key OFF, measure the resistance of the BK wire between pin 33 on BCM C1986 and BOB pin 1.</li> <li>• <b>Is the connector OK and are the resistances less than 5 ohms?</b></li> </ul>	<p>Yes = REPLACE the BCM.</p> <p>REFER to <a href="#">Section 414-03A</a> or <a href="#">Section 414-03B</a>.</p> <p>No = REPAIR the connectors and/or the wire in question between in-line C1939F and BCM C1986 or C1987. REFER to Communication Circuit Wiring Repair — Module in <b>Section 418-00 of the 2001 Ranger Workshop Manual</b> for repair of circuit 914 (T/O wire) and circuit 915 (PK/LB).</p>

**PINPOINT TEST C: THE MODULE DOES NOT RESPOND TO THE NGS TESTER —INTERFACE ADAPTER ASSEMBLY (IAA) MODULE**

TEST STEP	ACTION TO TAKE
<p><b>C1 CHECK FUSE, POWER, AND GROUND TO INTERFACE ADAPTER ASSEMBLY (IAA) MODULE</b></p> <ul style="list-style-type: none"> <li>• Check 10A fuse 9 in the electric vehicle power distribution box (EVPDB).</li> </ul>	<p>Yes = GO to C2.</p>

(Continued)

**DIAGNOSIS AND TESTING (Continued)****PINPOINT TEST C: THE MODULE DOES NOT RESPOND TO THE NGS TESTER —INTERFACE ADAPTER ASSEMBLY (IAA) MODULE**

TEST STEP	ACTION TO TAKE
<ul style="list-style-type: none"> <li>• With key OFF, disconnect IAA module C1945 and NGS Tester. Inspect IAA module C1945 and data link connector (DLC) C209 for damage.</li> <li>• Connect 104-Pin Breakout Box (BOB) to IAA module C1945; leave IAA module disconnected.</li> <li>• With key OFF, measure the voltage between BOB pins 75, 76 and ground (BOB pin 80). (V &gt; 10 volts)</li> <li>• With key OFF, measure the resistance between BOB pins 80, 81, 87 and ground. (R &lt; 5 ohms)</li> <li>• <b>Is everything OK?</b></li> </ul>	No = REPAIR as necessary.
<b>C2 CHECK CIRCUITS 914 (T/O) AND 915 (PK/LB) BETWEEN DLC C209 AND IAA MODULE C1945 FOR OPEN(S)</b> <ul style="list-style-type: none"> <li>• With key OFF, measure the resistance of the T/O wire between pin 2 on DLC C209 and BOB pin 28.</li> <li>• With key OFF, measure the resistance of the PK/LB wire between pin 10 on DLC C209 and BOB pin 27.</li> <li>• <b>Are the connectors OK and are the resistances less than 5 ohms?</b></li> </ul>	Yes = GO to C3. No = GO to C4.
<b>C3 CHECK IAA MODULE C1945 CONNECTION</b> <ul style="list-style-type: none"> <li>• Remove the BOB, reconnect IAA module C1945, and rerun DATA LINK DIAGNOSTICS Network Test.</li> <li>• <b>Does the IAA module respond to NGS Tester?</b></li> </ul>	Yes = System OK. No = REPLACE the IAA module. REFER to <a href="#">Section 412-04</a> .
<b>C4 CHECK CIRCUITS 914 (T/O) AND 915 (PK/LB) BETWEEN IN-LINE C136M AND IAA MODULE C1945 FOR OPEN</b> <ul style="list-style-type: none"> <li>• With key OFF, disconnect in-line C136 and inspect C136M and C136F for damage.</li> <li>• With key OFF, measure the resistance of the T/O wire between pin 25 on in-line C136M and BOB pin 28.</li> <li>• With key OFF, measure the resistance of the PK/LB wire between pin 21 on in-line C136M and BOB pin 27.</li> <li>• <b>Are the connectors OK and are the resistances less than 5 ohms?</b></li> </ul>	Yes = REPAIR the wire in question between in-line C136F and DLC C209. REFER to Communication Circuit Wiring Repair — Module in <b>Section 418-00 of the 2001 Ranger Workshop Manual</b> . No = REPAIR the connectors and/or the wire in question between in-line C136M and IAA module C1945. REFER to Communication Circuit Wiring Repair —Module in <b>Section 418-00 of the 2001 Ranger Workshop Manual</b> .

**PINPOINT TEST D: THE MODULE DOES NOT RESPOND TO THE NGS TESTER —TRACTION INVERTER MODULE (TIM)**

TEST STEP	ACTION TO TAKE
<b>D1 CHECK FUSE, POWER, AND GROUND TO TRACTION INVERTER MODULE (TIM)</b> <ul style="list-style-type: none"> <li>• Check 10A fuse 9, and 7.5A fuse 11 and 7.5 fuse 24 the I/P fuse panel.</li> </ul>	Yes = GO to D2.

(Continued)

**DIAGNOSIS AND TESTING (Continued)****PINPOINT TEST D: THE MODULE DOES NOT RESPOND TO THE NGS TESTER —TRACTION INVERTER MODULE (TIM)**

TEST STEP	ACTION TO TAKE
<ul style="list-style-type: none"> <li>• With key OFF, disconnect TIM C4998, C4999 and NGS Tester. Inspect TIM C4998, C4999 and DLC C209 for damage.</li> <li>• Connect 104-Pin Breakout Box (BOB) to TIM C4998, C4999 using the BCM/TIM BOB Adapter Cable &amp; Overlay; leave the TIM disconnected.</li> <li>• With key ON, measure the voltage between BOB pins A9, A10, A19, A20 and ground (BOB pin A29). (V &gt; 10 volts)</li> <li>• With key OFF, measure the resistance between BOB pins A29, A39 and ground. (R &lt; 5 ohms)</li> <li>• <b>Are the values correct?</b></li> </ul>	No = REPAIR as necessary.
<b>D2 CHECK CIRCUITS 914 (T/O) AND 915 (PK/LB) BETWEEN DATA LINK CONNECTOR (DLC) C209 AND TRACTION INVERTER MODULE (TIM) C4998 FOR OPEN(S)</b> <ul style="list-style-type: none"> <li>• With key OFF, measure the resistance of the T/O wire between pin 2 on DLC C209 and BOB pin A5.</li> <li>• With key OFF, measure the resistance of the PK/LB wire between pin 10 on DLC C209 and BOB pin A15.</li> <li>• <b>Are the connectors OK and are the resistances less than 5 ohms?</b></li> </ul>	Yes = GO to <b>D3</b> . No = GO to <b>D4</b> .
<b>D3 CHECK TIM C4998, C4999 CONNECTION</b> <ul style="list-style-type: none"> <li>• Remove the BOB, reconnect TIM C4998, C4999 and rerun DATA LINK DIAGNOSTICS Network Test.</li> <li>• <b>Does the TIM respond to NGS Tester?</b></li> </ul>	Yes = System OK. No = REPLACE the TIM. REFER to <a href="#">Section 303-14</a> .
<b>D4 CHECK CIRCUITS 914 (T/O) AND 915 (PK/LB) BETWEEN IN-LINE C3999F AND DLC C209 FOR OPEN(S)</b> <ul style="list-style-type: none"> <li>• With key OFF, disconnect in-line C3999 and inspect C3999M and C3999F for damage.</li> <li>• With key OFF, measure the resistance of the T/O wire between pin 11 on in-line C3999F and pin 2 on DLC C209.</li> <li>• With key OFF, measure the resistance of the PK/LB wire between pin 9 on in-line C3999F and pin 10 on DLC C209.</li> <li>• <b>Are the connectors OK and are the resistances less than 5 ohms?</b></li> </ul>	Yes = REPAIR the wire in question between in-line C3999M and TIM C4998. REFER to Communication Circuit Wiring Repair — Module in <b>Section 418-00 of the 2001 Ranger Workshop Manual</b> . No = GO to <b>D5</b> .
<b>D5 CHECK CIRCUITS 914 (T/O) AND 915 (PK/LB) BETWEEN IN-LINE C201F AND DLC C209 FOR OPEN(S)</b> <ul style="list-style-type: none"> <li>• With key OFF, disconnect in-line C201 and inspect C201M and C201F for damage.</li> <li>• With key OFF, measure the resistance of the T/O wire between pin 71 on in-line C201F and pin 2 on DLC C209.</li> <li>• With key OFF, measure the resistance of the PK/LB wire between pin 11 on in-line C201F and pin 10 on DLC C209.</li> <li>• <b>Are the connectors OK and is the resistance less than 5 ohms?</b></li> </ul>	Yes = REPAIR the wire in question between in-line C201M and in-line C3999F. REFER to Communication Circuit Wiring Repair — Module in <b>Section 418-00 of the 2001 Ranger Workshop Manual</b> . No = REPAIR the connectors and/or the wire in question between in-line C201F and DLC C209. REFER to Communication Circuit Wiring Repair — Module in <b>Section 418-00 of the 2001 Ranger Workshop Manual</b> .



**DIAGNOSIS AND TESTING (Continued)****PINPOINT TEST E: NO MODULE/NETWORK COMMUNICATION —ISO 9141 LINK**

TEST STEP	ACTION TO TAKE
<b>E1 CHECK NGS TESTER CONNECTOR AND DATA LINK CONNECTOR (DLC) C209</b> <ul style="list-style-type: none"> <li>• With key OFF, disconnect NGS Tester. Inspect terminals 5 and 7 on NGS Tester and pins 5 and 7 on DLC C209 for damage.</li> <li>• <b>Is everything OK?</b></li> </ul>	Yes = GO to <b>E2</b> . No = REPAIR as necessary.
<b>E2 CHECK THE CENTRAL TIMER MODULE (CTM) FOR THE SOURCE OF THE CONCERN</b> <ul style="list-style-type: none"> <li>• With key OFF, disconnect CTM C221 and inspect pin 25 for damage.</li> <li>• Run DATA LINK DIAGNOSTICS Network Test.</li> <li>• <b>Is the connector OK and is the result retrieved: CKT70 = ALL MODULES NO RESP/NOT EQUIP?</b></li> </ul>	Yes = GO to <b>E3</b> . No = REPAIR CTM C221 and/or REPLACE the CTM. REFER to <b>Section 419-10 of the 2001 Ranger Workshop Manual</b> .
<b>E3 CHECK THE ANTI-LOCK BRAKE CONTROL MODULE FOR THE SOURCE OF THE CONCERN</b> <ul style="list-style-type: none"> <li>• With key OFF, disconnect anti-lock brake control module C1942 and inspect pin 23 for damage.</li> <li>• Run DATA LINK DIAGNOSTICS Network Test.</li> <li>• <b>Is the connector OK and is the result retrieved: CKT70 = ALL MODULES NO RESP/NOT EQUIP?</b></li> </ul>	Yes = GO to <b>E4</b> . No = REPAIR anti-lock brake control module C1942 and/or REPLACE the anti-lock brake control module. REFER to <a href="#">Section 206-09</a> .
<b>E4 CHECK CIRCUIT 70 (LB/W) BETWEEN IN-LINE C1941M AND ANTI-LOCK BRAKE CONTROL MODULE C1942 FOR THE SOURCE OF THE CONCERN</b> <ul style="list-style-type: none"> <li>• With key OFF, disconnect in-line C1941 and inspect pin 7 for damage.</li> <li>• Run DATA LINK DIAGNOSTICS Network Test.</li> <li>• <b>Are the connectors OK and is the result retrieved: CKT70 = ALL MODULES NO RESP/NOT EQUIP?</b></li> </ul>	Yes = GO to <b>E5</b> . No = REPAIR the connectors and/or the LB/W wire between in-line C1941M and anti-lock brake control module C1942.
<b>E5 CHECK CIRCUIT 70 (LB/W) BETWEEN IN-LINE C1941F AND IN-LINE C134M FOR THE SOURCE OF THE CONCERN</b> <ul style="list-style-type: none"> <li>• With key OFF, disconnect in-line C134 and inspect pin 16 for damage.</li> <li>• Run DATA LINK DIAGNOSTICS Network Test.</li> <li>• <b>Are the connectors OK and is the result retrieved: CKT70 = ALL MODULES NO RESP/NOT EQUIP?</b></li> </ul>	Yes = GO to <b>E6</b> . No = REPAIR the connectors and/or the LB/W wire between in-line C1941M and in-line C134M.
<b>E6 CHECK THE ELECTRONIC CRASH SENSOR (ECS) MODULE FOR THE SOURCE OF THE CONCERN</b> <ul style="list-style-type: none"> <li>• With key OFF, deactivate the air bag system; refer to <b>Section 501-20B of the 2001 Ranger Workshop Manual</b>. Disconnect ECS module C250 and inspect pin 19 for damage.</li> <li>• Run DATA LINK DIAGNOSTICS Network Test.</li> <li>• <b>Is the connector OK and is the result retrieved: CKT70 = ALL MODULES NO RESP/NOT EQUIP?</b></li> </ul>	Yes = GO to <b>E7</b> . No = REPAIR ECS module C250 and/or REPLACE the ECS module. REFER to <b>Section 501-20B of the 2001 Ranger Workshop Manual</b> .
<b>E7 CHECK CIRCUIT 70 (LB/W) FOR SHORT TO POWER</b> <ul style="list-style-type: none"> <li>• With key ON, measure the voltage between pin 7 (LB/W wire) and pin 5 (BK/W wire) on DLC C209.</li> </ul>	Yes = REPAIR the LB/W wire.

(Continued)

**DIAGNOSIS AND TESTING (Continued)****PINPOINT TEST E: NO MODULE/NETWORK COMMUNICATION —ISO 9141 LINK**

TEST STEP	ACTION TO TAKE
<ul style="list-style-type: none"> <li>• Is the voltage greater than 0 volts?</li> </ul>	No = GO to E8.
<b>E8 CHECK CIRCUIT 70 (LB/W) FOR SHORT TO GROUND</b> <ul style="list-style-type: none"> <li>• With key ON, measure the resistance between pin 7 (LB/W wire) and pin 5 (BK/W wire) on DLC C209.</li> </ul>	Yes = REPAIR the LB/W wire between DLC C209 and S2987 for an open.
<ul style="list-style-type: none"> <li>• Is the resistance greater than 10,000 ohms?</li> </ul>	No = REPAIR the LB/W wire.

**PINPOINT TEST F: NO MODULE/NETWORK COMMUNICATION —SCP LINK**

TEST STEP	ACTION TO TAKE
<b>F1 CHECK THE NGS TESTER CONNECTOR AND DATA LINK CONNECTOR (DLC) C209</b> <ul style="list-style-type: none"> <li>• With key OFF, disconnect NGS Tester. Inspect terminals 2 and 10 on the NGS Tester and pins 2 and 10 on DLC C209 for damage.</li> <li>• Is everything OK?</li> </ul>	Yes = GO to F2. No = REPAIR as necessary.
<b>F2 CHECK THE INTERFACE ADAPTER ASSEMBLY (IAA) MODULE FOR THE SOURCE OF THE CONCERN</b> <ul style="list-style-type: none"> <li>• With key OFF, disconnect IAA module C1945 and inspect pins 27 and 28 for damage.</li> <li>• Run DATA LINK DIAGNOSTICS Network Test.</li> <li>• Are the connectors OK and is the result retrieved: CKT914 or CKT915 = ALL MODULES NO RESP/NOT EQUIP?</li> </ul>	Yes = GO to F3. No = REPAIR the connectors and/or REPLACE the IAA module. REFER to <a href="#">Section 412-04</a> .
<b>F3 CHECK THE TRACTION INVERTER MODULE (TIM) FOR THE SOURCE OF THE CONCERN</b> <ul style="list-style-type: none"> <li>• With key OFF, disconnect TIM C4998 and inspect pins 5 and 15 for damage.</li> <li>• Run DATA LINK DIAGNOSTICS Network Test.</li> <li>• Are the connectors OK and is the result retrieved: CKT914 or CKT915 = ALL MODULES NO RESP/NOT EQUIP?</li> </ul>	Yes = GO to F4. No = REPAIR the connectors and/or REPLACE the TIM. REFER to <a href="#">Section 303-14</a> .
<b>F4 CHECK THE BATTERY CONTROL MODULE (BCM) AND CIRCUITS 914 (T/O) AND 915 (PK/LB) BETWEEN IN-LINE C1939F AND BCM FOR THE SOURCE OF THE CONCERN</b> <ul style="list-style-type: none"> <li>• With key OFF, disconnect in-line C1939 and inspect pins 58 and 59 for damage.</li> <li>• Run DATA LINK DIAGNOSTICS Network Test.</li> <li>• Are the connectors OK and is the result retrieved: CKT914 or CKT915 = ALL MODULES NO RESP/NOT EQUIP?</li> </ul>	Yes = GO to F6. No = GO to F5.
<b>F5 CHECK THE BCM FOR THE SOURCE OF THE CONCERN</b> <ul style="list-style-type: none"> <li>• With key OFF, reconnect in-line C1939. Disconnect BCM C1987 and inspect pins 20 and 21 for damage.</li> <li>• Run DATA LINK DIAGNOSTICS Network Test.</li> <li>• Are the connectors OK and is the result retrieved: CKT914 or CKT915 = ALL MODULES NO RESP/NOT EQUIP?</li> </ul>	Yes = REPAIR the T/O wire and/or PK/LB wire between in-line C1939F and BCM C1987. REFER to Communication Circuit Wiring Repair —Module in <b>Section 418-00 of the 2001 Ranger Workshop Manual</b> . No = REPAIR the connectors and/or REPLACE the BCM. REFER to <a href="#">Section 414-03A</a> or <a href="#">Section 414-03B</a> .
<b>F6 CHECK CIRCUITS 914 (T/O) AND 915 (PK/LB) FOR SHORT(S) TO POWER</b>	

(Continued)

**DIAGNOSIS AND TESTING (Continued)****PINPOINT TEST F: NO MODULE/NETWORK COMMUNICATION —SCP LINK**

TEST STEP	ACTION TO TAKE
<ul style="list-style-type: none"> <li>• With key OFF, reconnect in-line C1939 and disconnect BCM C1987.</li> <li>• Connect 104-Pin Breakout Box (BOB) to IAA module C1945; leave IAA module disconnected.</li> <li>• With key ON, measure the voltage between BOB pin 27 and ground (BOB pin 80).</li> <li>• With key ON, measure the voltage between BOB pin 28 and ground (BOB pin 80).</li> <li>• <b>Are any of the voltages greater than 0 volts?</b></li> </ul>	Yes = REPAIR the wire(s) in question. No = GO to <b>F7</b> .
<b>F7 CHECK CIRCUITS 914 (T/O) AND 915 (PK/LB) FOR SHORT(S) TO GROUND</b> <ul style="list-style-type: none"> <li>• With key OFF, measure the resistance between BOB pin 27 and ground (BOB pin 80).</li> <li>• With key OFF, measure the resistance between BOB pin 28 and ground (BOB pin 80).</li> <li>• <b>Are the resistances greater than 10,000 ohms?</b></li> </ul>	Yes = REPAIR the T/O wire between DLC C209 and S2992 and/or the PK/LB wire between DLC C209 and S2990 for an open. No = REPAIR the wire(s) in question.

**PINPOINT TEST G: NO MODULE/NETWORK COMMUNICATION**

TEST STEP	ACTION TO TAKE
<b>G1 CHECK NGS TESTER CONNECTOR AND DATA LINK CONNECTOR (DLC) C209</b> <ul style="list-style-type: none"> <li>• With key OFF, disconnect NGS Tester. Inspect NGS terminals and DLC C209 pins for damage.</li> <li>• <b>Is everything OK?</b></li> </ul>	Yes = GO to <b>G2</b> . No = REPAIR as necessary.
<b>G2 CHECK FUSE, IGNITION POWER, AND GROUND TO DLC C209</b> <ul style="list-style-type: none"> <li>• Check 7.5A fuse 5 in the I/P fuse panel.</li> <li>• With key OFF, disconnect the NGS tester and measure the resistance between pin 5 (BK/W wire) on DLC C209 and ground. (R &lt; 5 ohms)</li> <li>• With key ON, measure the voltage between pin 16 (O wire) on DLC C209 and ground. (V &gt; 10 volts)</li> <li>• <b>Are the values correct?</b></li> </ul>	Yes = REPAIR or REPLACE the NGS Tester. No = REPAIR as necessary.

# Alphabetical Index

## A

A/C Compressor .....	412-03-12
A/C Inverter Motor Controller, Description and Operation .....	412-03-2
A/C Inverter Motor Controller, Removal and Installation .....	412-03-15
Acceleration Control, Description and Operation .....	310-02-2
Acceleration Control, Diagnosis and Testing .....	310-02-2
Acceleration Position Sensor .....	310-02-6
Acceleration Position Sensor — Postal Ranger EV .....	310-02-7
Air Conditioning, Description and Operation .....	412-03-2
Air Conditioning, Diagnosis and Testing .....	412-03-3
Air Distribution and Filtering .....	412-01-2
Air Filter .....	412-01-2
Air Filter — Postal Ranger EV .....	412-01-7
Anti-Lock Brake and Regenerative Braking System .....	206-09-2
Anti-Lock Brake Control Module .....	206-09-13
Anti-Lock Brake Sensor — Front .....	206-09-15
Anti-Lock Brake Sensor — Rear .....	206-09-15
Anti-Lock Control .....	206-09-3
Automatic Transaxle External Controls .....	307-05-2
Auxiliary Battery Capacity Test .....	414-02-8
Auxiliary Battery Charging, Description and Operation .....	414-02-2
Auxiliary Battery Charging, Diagnosis and Testing .....	414-02-3
Auxiliary Battery Charging, General Procedures .....	414-02-8
Auxiliary Contactor Relay Control, Diagnosis and Testing .....	414-03A-5
Auxiliary Contactor Relay Control, Diagnosis and Testing .....	414-03B-6
Electrical Schematic .....	414-03B-6
Symptom Chart .....	414-03B-6
Pinpoint Tests .....	414-03B-6
Inspection and Verification .....	414-03B-6

## B

Basic Motor/Transaxle, Description and Operation .....	303-01-2
Battery Control Module (BCM), Removal and Installation .....	414-03A-94
Battery Control Module (BCM), Removal and Installation .....	414-03B-92
Battery Tray Seal, General Procedures .....	414-03A-93
Battery Tray Seal, General Procedures .....	414-03B-90
Buffer Zone .....	100-05-2

## C

Charge Inlet, Removal and Installation .....	414-03A-96
Charge Inlet, Removal and Installation .....	414-03B-94
Communications Network .....	418-00-3
Compressor .....	412-03-2
Condenser Fan .....	100-04-2
Condenser Fan — Postal Ranger EV .....	100-04-2
Contactor Box, Removal and Installation .....	414-03A-99
Contactor Box, Removal and Installation .....	414-03B-97
Contactor Box Current Sensors, Diagnosis and Testing .....	414-03A-21
Contactor Box Current Sensors, Diagnosis and Testing .....	414-03B-21
Electrical Schematic .....	414-03B-21
Inspection and Verification .....	414-03B-21
Pinpoint Tests .....	414-03B-22
Symptom Chart .....	414-03B-22
Contactor Box Fuses, Removal and Installation .....	414-03A-103
Contactor Box Fuses, Removal and Installation .....	414-03B-101
Control Components .....	412-04-2
Coolant Pump .....	303-03-14
Coolant Pump — Postal Ranger EV .....	303-03-15
Cooling Fan .....	303-03-17
Cooling System, Description and Operation .....	303-03-2
Cooling System, Diagnosis and Testing .....	303-03-4
Cooling System — Postal Ranger EV .....	303-03-3
Cooling System Drain, Fill and Bleed .....	303-03-10
Cooling System Tubes and Hoses .....	303-03-18
Cooling System Tubes and Hoses — Postal Ranger EV .....	303-03-20
Current Leakage Detection, Diagnosis and Testing .....	414-03A-24
Current Leakage Detection, Diagnosis and Testing .....	414-03B-25
Electrical Schematic .....	414-03B-25
Inspection and Verification .....	414-03B-25
Symptom Chart .....	414-03B-25
Pinpoint Tests .....	414-03B-26

## D

DC/DC Converter .....	414-02-8
Digital Transmission Range (DTR) Sensor, Diagnosis and Testing .....	307-05-2
Digital Transmission Range (DTR) Sensor, Removal and Installation .....	307-05-16
Digital Transmission Range (DTR) Sensor Alignment .....	307-05-11

# Alphabetical Index

## E

Electric Motor Management .....	303-14-2
Electric Vehicle (EV) Diagnostic Direction .....	100-07-2
Emergency Power Off (EPO)/Interlock System, Diagnosis and Testing .....	414-03A-17
Emergency Power Off (EPO)/Interlock System, Diagnosis and Testing .....	414-03B-18
Electrical Schematic .....	414-03B-18
Symptom Chart .....	414-03B-18
Pinpoint Tests .....	414-03B-18
Inspection and Verification .....	414-03B-18

## F

Flow Through Blower .....	414-03B-122
---------------------------	-------------

## G

Gauges and Warning Lamps .....	413-01-2
General Information .....	100-00-2

## H

Halfshafts .....	205-05-2
Heating/Defrosting .....	412-02-2
Heating/Defrosting — Postal Ranger EV .....	412-02-2
Heating/Defrosting/Ventilation System .....	412-02-3
High Voltage Power Distribution Box (HVPDB), Removal and Installation .....	414-03A-106
High Voltage Power Distribution Box (HVPDB), Removal and Installation .....	414-03B-105
High Voltage Wiring, Removal and Installation .....	414-03A-113
High Voltage Wiring, Removal and Installation .....	414-03B-111
High Voltage Wiring — Sensor Lead Harness (10B694) .....	414-03B-106
High Voltage Wiring — Sensory Lead Harness (10B694) .....	414-03A-108
High Voltage/Traction Battery, Description and Operation .....	414-03A-3
High Voltage/Traction Battery, Description and Operation .....	414-03B-4
Hub .....	204-02-3
HVPDB Fuses, Removal and Installation .....	414-03A-105

HVPDB Fuses, Removal and Installation .....	414-03B-103
Hydraulic Control Unit, Description and Operation .....	206-09-2
Hydraulic Control Unit, Removal and Installation .....	206-09-16

## I

Identification Codes .....	100-01-2
Independent Observer Module — (IOM) .....	414-03B-169
Indicator Bulbs .....	413-01-6
Instrument Cluster .....	413-01-7
Instrument Cluster — Postal Ranger EV .....	413-01-34
Interface Adapter Assembly (IAA) Module .....	412-04-2

## J

Jacking .....	100-02-2
---------------	----------

## M

Main/Precharge Contactor Relay Control, Diagnosis and Testing .....	414-03A-10
Main/Precharge Contactor Relay Control, Diagnosis and Testing .....	414-03B-11
Electrical Schematic .....	414-03B-11
Symptom Chart .....	414-03B-11
Inspection and Verification .....	414-03B-11
Pinpoint Tests .....	414-03B-12
Miscellaneous Diagnostics .....	100-07-24
Module Charging, General Procedures .....	414-03A-77
Module Charging, General Procedures .....	414-03B-91
Module Communication .....	418-00-2
Motor/Transaxle, Removal and Installation .....	303-01-10
Motor/Transaxle Lubrication System, Diagnosis and Testing .....	303-01-3
Motor/Transaxle Shift Cable .....	307-05-14
Multiple Auxiliary Load Failure Diagnosis, Diagnosis and Testing .....	414-03A-76
Multiple Auxiliary Load Failure Diagnosis, Diagnosis and Testing .....	414-03B-76
Inspection and Verification .....	414-03B-76
Electrical Schematic .....	414-03B-76
Pinpoint Tests .....	414-03B-77
Symptom Chart .....	414-03B-77

# Alphabetical Index

## N

Negative Contactor Relay Control, Diagnosis and Testing ..... 414-03A-15

Negative Contactor Relay Control, Diagnosis and Testing ..... 414-03B-16

Electrical Schematic..... 414-03B-16

Inspection and Verification..... 414-03B-16

Symptom Chart ..... 414-03B-16

Pinpoint Tests ..... 414-03B-16

## O

Oil Change Procedure, General Procedures ..... 303-01-7

Oil Level Check Procedure, General Procedures ..... 303-01-6

## P

Parking Brake Assembly ..... 206-05-2

Parking Brake Cables — Front..... 206-05-7

Parking Brake Cables — Intermediate..... 206-05-10

Parking Brake Cables — Postal Ranger EV ..... 206-05-7

Parking Brake Cables — Rear ..... 206-05-9

Positive Temperature Coefficient (PTC) Switching Module ..... 412-04-4

Power Disc Brake Actuation..... 206-07-2

Power Steering, Description and Operation..... 211-02-2

Power Steering, Diagnosis and Testing ..... 211-02-3

Power Steering — Postal Ranger EV ..... 211-02-2

Power Steering Assembly ..... 211-02-8

Power Steering Gear ..... 211-02-10

Power Steering Gear — Postal Ranger EV..... 211-02-13

Power Steering Pump ..... 100-04-2

Power Steering Pump Hoses — Pressure Hose ..... 211-02-13

Power Steering Pump Hoses — Pressure Hose - Postal Ranger EV ..... 211-02-15

Power Steering Pump Hoses — Return Hose ..... 211-02-17

Power Steering Pump Hoses — Return Hose - Postal Ranger EV ..... 211-02-19

Power Steering Pump Hoses — Supply Hose ..... 211-02-20

Power Steering Pump Hoses — Supply Hose - Postal Ranger EV ..... 211-02-21

Power Steering Reservoir ..... 211-02-22

Power Steering Reservoir — Postal Ranger EV ..... 211-02-23

Powertrain Diagnostic Routines Identification ..... 100-09-2

Pre-Delivery Form ..... 100-06-2

PRNDE Shifter Adjustment ..... 307-05-10

PTC Heater Core — Electric Ranger ..... 412-02-31

PTC Heater Core — Postal Ranger EV ..... 412-02-36

## R

Rear Axle ..... 204-02-3

Rear Disc Brakes ..... 206-04-2

Rear Disc Brakes — Caliper ..... 206-04-3

Rear Disc Brakes — Rotor ..... 206-04-5

Rear Shock Absorber ..... 204-02-14

Rear Suspension ..... 204-02-2

Recirculating Blower ..... 414-03B-124

Regenerative Braking, Diagnosis and Testing ..... 414-03A-38

Regenerative Braking, Diagnosis and Testing ..... 414-03B-36

Inspection and Verification..... 414-03B-36

Electrical Schematic..... 414-03B-36

Pinpoint Tests ..... 414-03B-37

Symptom Chart ..... 414-03B-37

Rubber Insulating Gloves Testing ..... 100-05-2

## S

Safety Precautions ..... 204-04-2

**SPECIFICATIONS**

Basic Motor/Transaxle ..... 303-01-2

Engine Cooling ..... 303-03-2

Electric Motor Management ..... 303-14-2

Rear Suspension ..... 204-02-2

Wheels and Tires ..... 204-04-2

Rear Drive Halfshafts ..... 205-05-2

Rear Disc Brake ..... 206-04-2

Parking Brake and Actuation..... 206-05-2

Power Brake Actuation ..... 206-07-2

Anti-Lock Control ..... 206-09-2

Automatic Transaxle External Controls..... 307-05-2

Acceleration Control..... 310-02-2

Power Steering ..... 211-02-2

Air Distribution and Filtering ..... 412-01-2

Heating and Ventilation ..... 412-02-2

Air Conditioning ..... 412-03-2

Control Components ..... 412-04-2

Auxiliary Battery Charging ..... 414-02-2

High Voltage/Traction Battery..... 414-03A-3

High Voltage/Traction Battery — Nickel Metal Hydride ..... 414-03B-3

Spring ..... 204-02-16

Steering Column Switches ..... 211-05-2

Steering Wheel Sensor..... 211-02-24

# Alphabetical Index

## T

Towing .....	100-02-3
Traction Battery, Disassembly and Assembly .....	414-03B-172
Traction Battery, Removal and Installation .....	414-03A-115
Traction Battery, Removal and Installation .....	414-03B-114
Traction Battery Auxiliary Load High-Voltage Connector .....	100-05-6
Traction Battery Charger, Removal and Installation .....	414-03A-120
Traction Battery Charger, Removal and Installation .....	414-03B-119
Traction Battery Charging .....	100-05-3
Traction Battery Charging/Heating System, Diagnosis and Testing .....	414-03A-41
Traction Battery Charging/Heating System, Diagnosis and Testing .....	414-03B-39
Electrical Schematic .....	414-03B-40
Inspection and Verification .....	414-03B-40
Symptom Chart .....	414-03B-41
Pinpoint Tests .....	414-03B-42
Traction Battery Cooling/Ventilation Fan, Description and Operation .....	100-04-2
Traction Battery Cooling/Ventilation Fan, Removal and Installation .....	414-03A-123
Traction Battery Cooling/Ventilation System, Diagnosis and Testing .....	414-03A-62
Traction Battery Cooling/Ventilation System, Diagnosis and Testing .....	414-03B-62
Symptom Chart .....	414-03B-62
Pinpoint Tests .....	414-03B-62
Electrical Schematic .....	414-03B-62
Inspection and Verification .....	414-03B-62
Traction Battery Heating Elements (U/L) — Lower .....	414-03A-125
Traction Battery Heating Elements (U/L) — Upper .....	414-03A-124
Traction Battery High Voltage Fuse (250A), Removal and Installation .....	414-03A-125
Traction Battery High Voltage Fuse (250A), Removal and Installation .....	414-03B-129
Traction Battery Module — Modules 1, 7, 8, 9, 25 .....	414-03B-140
Traction Battery Module — Modules 1-7 .....	414-03A-128
Traction Battery Module — Modules 10, 11, 12, 23, 24 .....	414-03B-147
Traction Battery Module — Modules 12-15, 28-31 .....	414-03A-133
Traction Battery Module — Modules 13-15 .....	414-03B-151
Traction Battery Module — Modules 16, 19, 20, 22 .....	414-03B-163
Traction Battery Module — Modules 16, 25-27 .....	414-03A-133
Traction Battery Module — Modules 17, 18, 21 .....	414-03B-156
Traction Battery Module — Modules 17-18 .....	414-03A-128
Traction Battery Module — Modules 19-21 .....	414-03A-129

Traction Battery Module — Modules 2-6 .....	414-03B-134
Traction Battery Module — Modules 22-24 .....	414-03A-135
Traction Battery Module — Modules 34-39 .....	414-03A-131
Traction Battery Module — Modules 8-11 .....	414-03A-129
Traction Battery Module Replacement, General Procedures .....	414-03A-78
Traction Battery Module Replacement, General Procedures .....	414-03B-78
Traction Battery System, Diagnosis and Testing .....	414-03A-65
Traction Battery System, Diagnosis and Testing .....	414-03B-67
Battery Module Diagnostic Test .....	414-03B-67
Electrical Schematic .....	414-03B-69
Symptom Chart .....	414-03B-69
Inspection and Verification .....	414-03B-69
Pinpoint Tests .....	414-03B-70
Traction Battery Temperature Sensor, Disassembly and Assembly .....	414-03A-138
Traction Battery Temperature Sensor, Removal and Installation .....	414-03B-131
Traction Battery Temperature Sensor — Modules 22-24 .....	414-03A-136
Traction Battery Tray Repair, General Procedures .....	414-03A-89
Traction Battery Tray Repair, General Procedures .....	414-03B-86
Traction Battery Two-Pin High-Voltage Connector .....	100-05-7
Traction Inverter Module (TIM) .....	303-14-6
Traction Inverter Module (TIM) Capacitor Discharge .....	100-05-9
Traction Inverter Module (TIM) Control System .....	303-14-2
Transaxle .....	100-04-2

## V

Vacuum Pressure Sensor .....	206-07-8
Vacuum Pump, Description and Operation .....	100-04-2
Vacuum Pump, Removal and Installation .....	206-07-10
Vacuum System .....	206-07-3
Variable Blower Controller (VBC) .....	412-04-5

## W

Warnings .....	100-01-2
Wheel and Tire .....	204-04-6
Wheel Bearing .....	204-02-24
Wheel Leaks .....	204-04-5
Wheels and Tires, Description and Operation .....	204-04-2
Wheels and Tires, Diagnosis and Testing .....	204-04-3